



# Instruction Manual

## Introduction

Thank you for purchasing the INNO Roof Box.

Please read this instruction manual thoroughly before using your roof box. Keep this manual in a safe place where anyone using the roof box can use it for reference. If for any reason you lend/sell this roof box to someone else, please make sure that you also give them this instruction manual. If any sections of this manual are unclear or difficult to understand, please contact our service center shown in this manual.

The following symbols are used in this manual.

	<b>Warning</b>	Failing to observe these warnings may lead to serious accidents that may cause death or serious injury.
	<b>Caution</b>	Failing to observe these cautions may lead to injuries, and/or damage to the roof box, vehicle, and surrounding objects.
	<b>Reference</b>	Explains points that you should know about when using the roof box.

## Check the Product Contents

This roof box product contains the following parts. Check to make sure you have all necessary parts described below. If any part is missing, contact our service center listed in this manual.

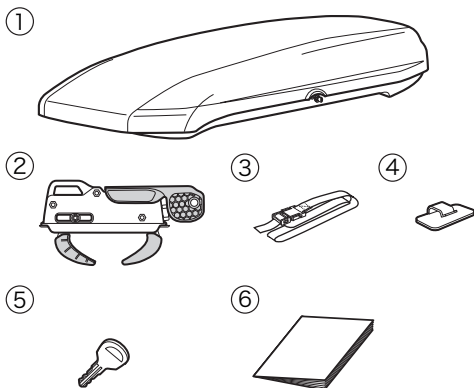

NO.	Part name	Qty
①	Roof box	1
②	Memory-mount	4
③	Belt	2
④	Belt hook	2
⑤	Key	2
⑥	Instruction manual	1

**Dimensions of installation hardware**

■ Mountable bar dimensions

H: 20~35mm (0.75\"~1.37\")  
T: Distance to the roof : Allow minimum 50mm (2\")

This roof box is mountable onto genuine base carriers and crossbars of the vehicle manufacturer, as well as the INNO square bars. Make sure to install the base carrier and/or crossbars securely.

**Warning**

Refer to the instruction manual of your vehicle or carrier to make sure that the carriers and/or crossbars are strong enough to mount this product. If you are not sure of the strength do not mount.

## Assembly diagram

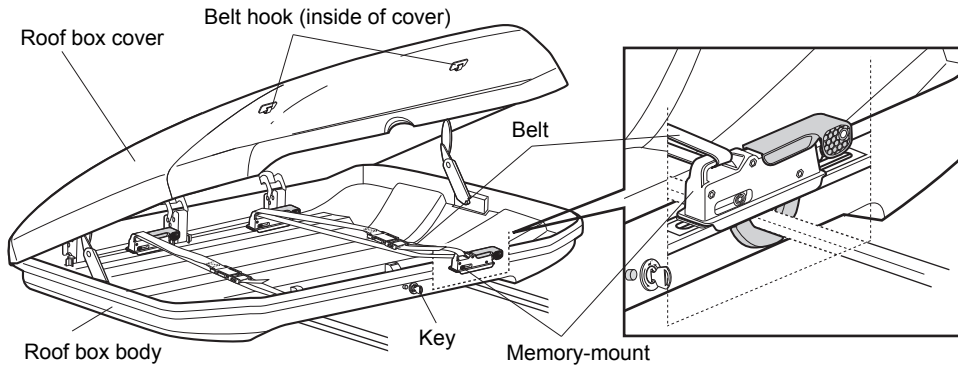

## Opening and Closing

### Dual Open (Open/close from either side)

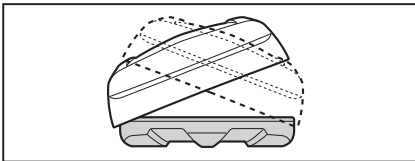

This roof box can be opened and closed from both left and right hand sides.

#### ⚠ Caution

Do not open the left and right side covers simultaneously. Always make sure to close one side completely before opening the opposite side.

### Opening the cover

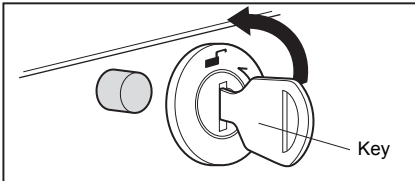

**1** Insert the key into the key cylinder and turn the key 90° in the "↻" direction.

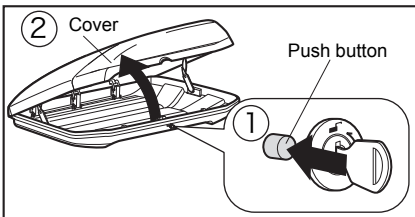

**2** ① Push the Push button until you hear a click sound. ② Lift the roof box cover to open it completely.

#### 📖 Reference

If the cover catches against something or is difficult to open, do not force it to open. Close the cover, then lift it again making sure that it remains level.

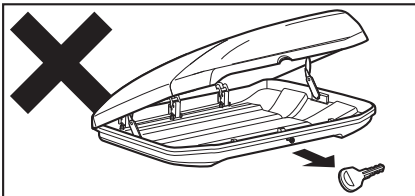

#### ⚠ Caution

The key cannot be pulled out while the cover is open. To pull out the key, close the cover first, then turn the key and remove it.

## Installation method

### Installing the base carrier on the vehicle

Distance between front  
and rear cross bars  
60~100cm(23.6~39 inches)  
Recommended 80cm(31.5 inches)

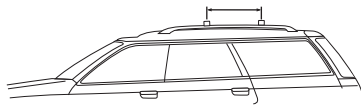

**1** Install the base carrier correctly on the vehicle.

#### **⚠ Caution**

Make sure the distance between the front and rear base carriers is more than 60cm (23.6 inches). If the distance is too narrow, too much pressure will be exerted on the roof box, which may cause it to fall off the vehicle.

#### **📖 Reference**

If you can adjust the distance between the front and rear base carriers, a distance of approximately 80cm (31.5 inches) will stabilize the box and will also reduce the load concentration on the vehicle.

### Deciding the installation position of the Roof Box

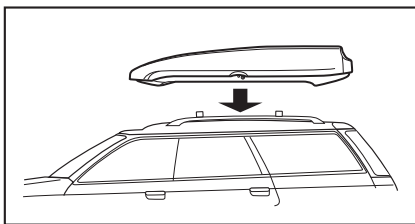

**1** Temporarily place the roof box on the base carrier.

#### **⚠ Warning**

Refer to the instruction manual of your vehicle or carrier to make sure that the carriers and/or crossbars are strong enough to mount this product. If you are not sure of the strength do not mount.

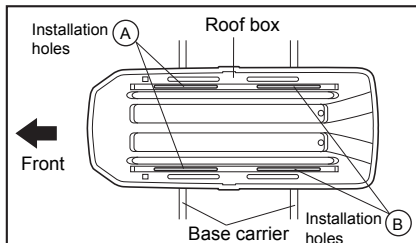

**2** Determine the installation position by aligning the installation holes (A) and (B) with the front and rear base carriers.

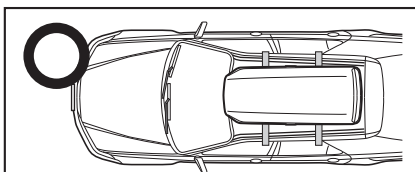

#### **⚠ Caution**

Make sure to install the roof box so that it runs parallel with the direction of the vehicle.

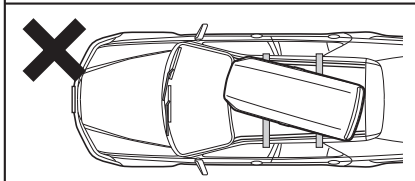

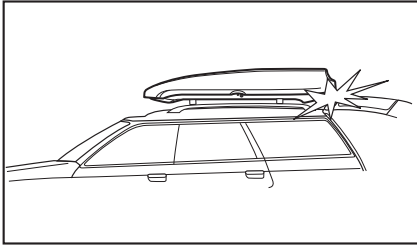

### If your vehicle has a rear trunk

Before installation, open the trunk fully to ensure it does not touch the roof box. If it does, change positions either the roof box or the basic carrier.

**⚠ Caution**

Some vehicle types have specific installation positions of the basic carriers, and touching the trunk is unavoidable. Open the trunk carefully not to damage the roof box.

### Installing the quick-mount

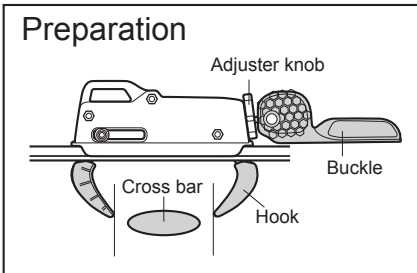
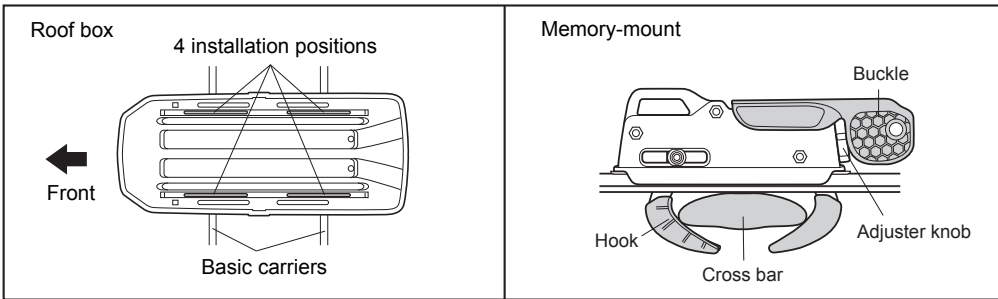

Widen the hooks using the adjuster knob to put the basic carrier bar inside.

**⚠ Caution**

Before installation, adjust hooks with the cross bar.

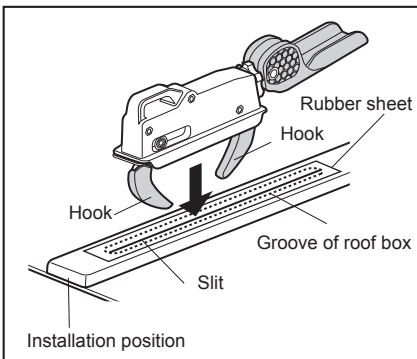

**1** Insert the hooks of the Memory-mount into the rubber sheet inside of the roof box. Ensure the basic carrier bar stays inside of the hooks.

**⚠ Caution**

When the hooks are inserted, the rubber sheet is cut. The orientation of the Memory-mount usually does not matter, but follow the instructions of your basic carrier for specific installation positions.

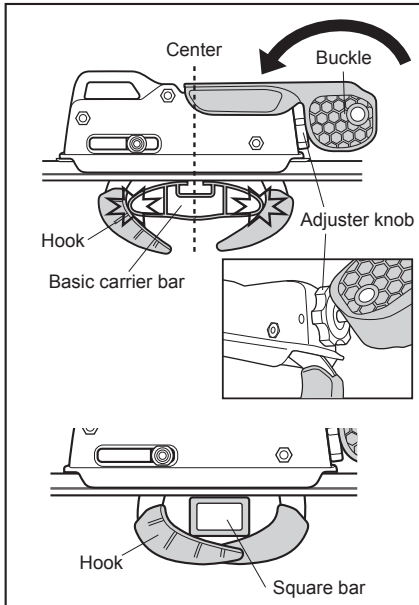

**2** Close the buckle. Turn the adjuster knob as the arrow indicates (or clockwise) to align the centers of both hooks and the basic carrier.

**⚠ Caution**

Ensure both hooks are bilaterally symmetric with the center of the basic carrier bar. The hooks may loosen over time if they are not symmetrically positioned.

**📖 Reference**

When the square bar is placed, keep the tips of the hooks as close as illustrated.

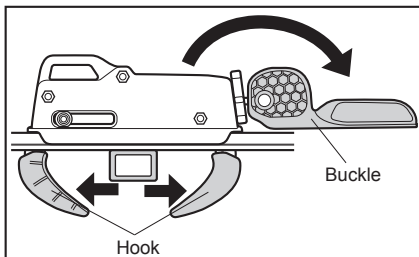

**3** Lift the buckle. Turn the adjuster knob as the arrow indicates (or clockwise) 2 times. Close the buckle again and readjust the tightness of the hooks.

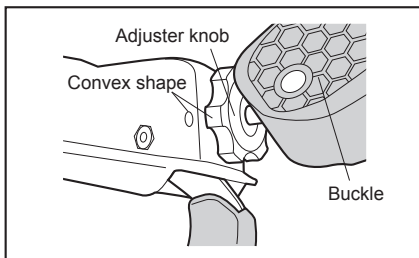

**📖 Reference**

- Adjuster knob has a convex shape to indicate how many turns are made.
- Depending on the shape of the basic carrier bar, make more or less turns to tighten the hooks.

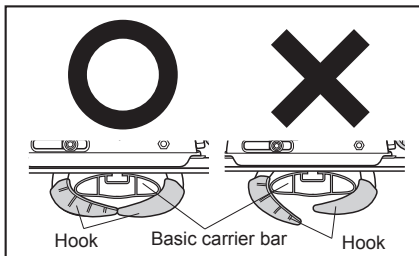

**⚠ Caution**

Ensure both hooks are bilaterally symmetric with the center of the basic carrier bar. The hooks may loosen over time if they are not symmetrically positioned.

## Detaching the Roof Box

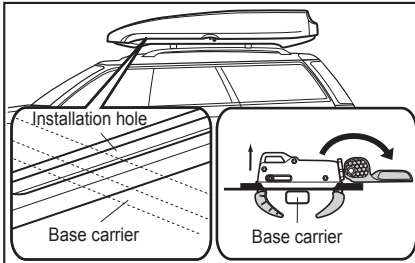

- 1 Detach the knobs, and pull out the bolts from the spacer side.

## Installing the Belt/Belt Hooks

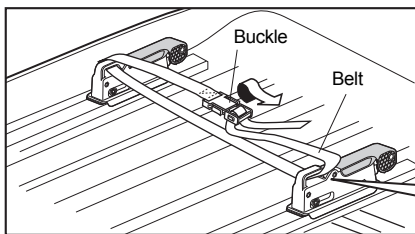

- 1 Pass the belt through the belt rings, and pass it through the buckle.

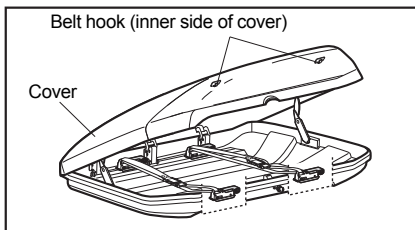
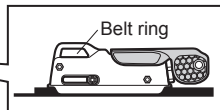

- 2 Paste the belt hooks onto the upper side of the belts, in a position that the belt can be hooked easily onto the inner side of the cover.

### Reference

After pasting the belt hooks, leave them for 24 hours without hooking on the belts for better adhesion.

## Checking the Roof Box Installation

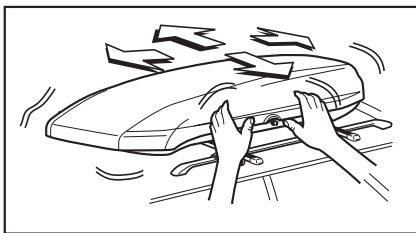

- 1 Shake the roof box back and forth, left to right to make sure that there is no rattling due to loose knobs and that the carrier is securely fixed on the vehicle. If you hear or feel rattling, tighten all installation sections again. Make sure also that the centers of "R" on the bolt and the base carriers are aligned.

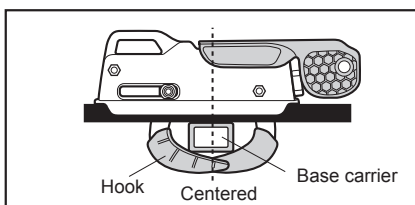

## Using the Roof Box

Maximum 50kg (110 lbs.)

Front : Center : Rear  
 10 kg : 27 kg : 13 kg  
 (22 lbs.) : (59 lbs.) : (28 lbs.)



The maximum load is 50kg(110 lbs.). Make sure that items are loaded evenly in all directions within the roof box. Take extra care not to load items that exceeds 10kg(22 lbs.) at the front side of the box.

### Reference

- Loading more than 50kg(110 lbs.) and/or loading items unevenly may lead to damage to, and/or separation of the roof box.
- There may be varied maximum load limitations depending on the make and model of vehicle. Consult the fit guide in your local store for any additional limitations.

### Calculating the maximum loading capacity

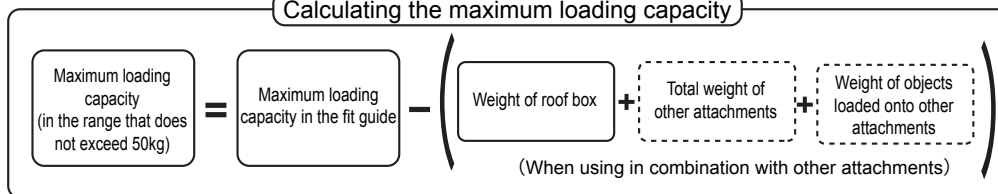

### Loading your Items

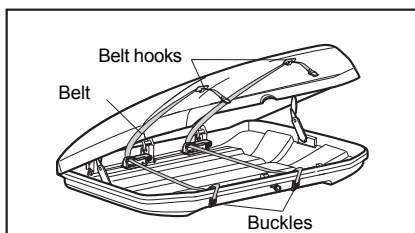

- 1 Remove the belt buckles and hook the belts on the belt hooks.

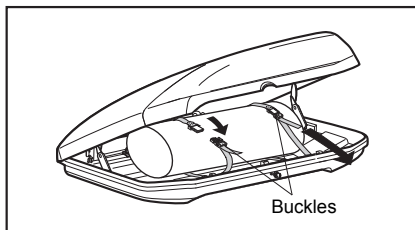

- 2 Remove the belts on the belt hooks, insert them into the buckles and fasten.

### Warning

Make sure that the items inside the box are securely fastened with the belts while driving.

### Reference

If the items are not fastened securely enough, they may move around inside the box while driving, making it difficult to open the cover. If this occurs, press the button while pushing the cover down.

### Caution

Do not close the cover forcefully when the box is overloaded. This may cause the cover not to close firmly, and the roof box and/or the items may be damaged.

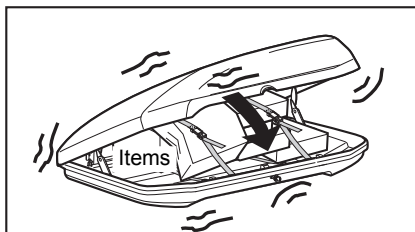

**Warning**

**Observe local speed limit**



When driving with items loaded, observe the local speed limit. Reduce your driving speed in strong winds and bad road conditions.

**Close the cover securely**



Close the cover securely. Failing to do so may cause the cover to open while driving, and the roof box to be damaged and/or to fall off the vehicle roof due to wind pressure.

**Do not alter the product**

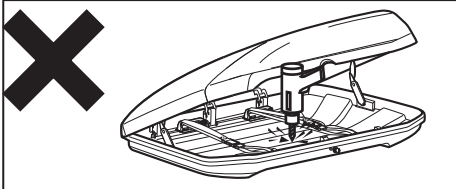

Do not alter the product by drilling holes, etc.

**Fasten items with belts**

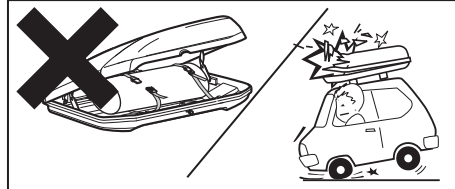

Make sure that the items inside the box are securely fastened with the belts. Failing to do so may cause the loaded items and the box to be damaged, or the items to fall out of the roof box during sudden braking.

**Do not load these items**

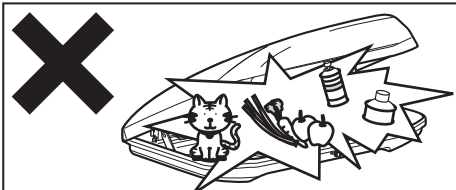

Do not load the items described on the right.

1. Spray cans containing high pressure gas
2. Flammable liquids such as gasoline, paraffin, etc
3. Precision mechanical equipment
4. Living creatures (pets, etc.)
5. Raw materials (vegetables, etc.)

Temperature of the inside of the roof box may become increase due to direct sunlight. Loading these items may lead to explosion, fire, death through dehydration, damage/deformation due to heat, or decomposition.

**Do not use oils and thinners (including paints)**

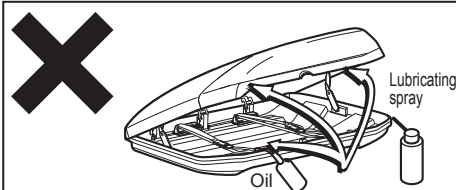

Using any type of lubricating spray, oil, grease, thinner, or detergent may cause the roof box materials to deteriorate, which leads to damage to and separation of the roof box. Do not apply oil to the keys and hinge sections.

**Check loose bolts/parts**

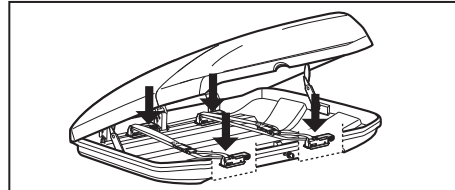

Before driving, check the 4 installation locations for loose bolts/parts. Re-tighten them if any bolts/parts are loose.



**⚠ Caution**

**Trunk (rear gate)**

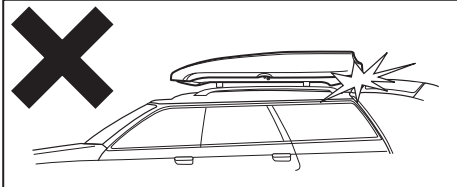

Make sure that the vehicle trunk (rear gate) does not hit the roof box when opening.

**Not fully waterproof**

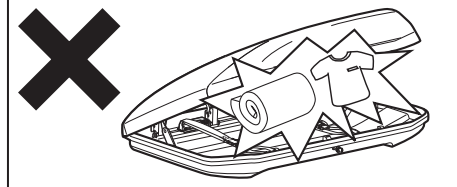

The roof box is not constructed to be completely waterproof. Loaded items may get wet due to strong rain.

**Opening and closing during strong winds**

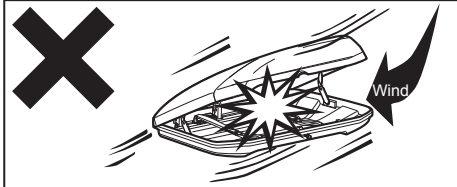

Opening and closing the roof box during strong gusts or winds may cause the box to be damaged, or have your body trapped in the box, leading to injury.

**Avoid sudden maneuvers**

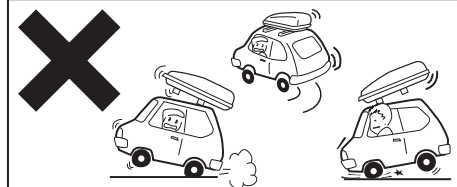

Avoid sudden starts, sudden turns, and sudden braking as much as possible. Such maneuvers may cause the installation sections of the roof box and the carrier to side out of place, which may lead to damage to the vehicle or roof box.

**Vehicle height**

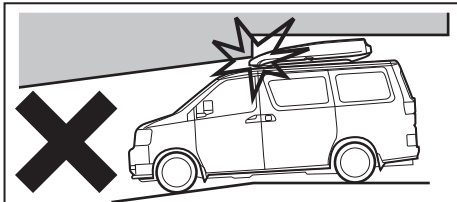

Always remember that the vehicle height has increased when the carrier is installed.

**Automatic car wash**



Always remove the carrier before going through an automatic car wash.

## Daily maintenance / Storage

If the roof box becomes dirty, wash it with water.

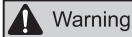

Warning

### Do not use detergents and wax

When washing the roof box, do not use detergents and wax. The roof box materials may deteriorate depending on the type of detergent or wax.

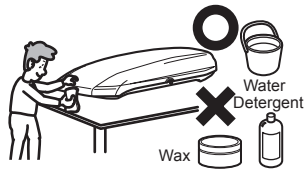

Warning

### Do not use oils and thinners (including paints)

Using any type of lubricating spray, oil, grease, thinner, or detergent may cause the roof box materials to deteriorate, which leads to damage to and separation of the roof box. Do not apply oil to the keys and hinge sections.

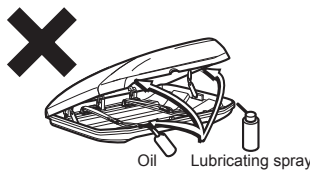

If you do not plan to use the roof box for a long period of time, remove the roof box from the vehicle roof, inspect every part of it, and store it away from direct sunlight.



Reference

### Store in a cool place (avoid UV rays)

The roof box materials gradually deteriorate due to exposure to UV light. If you do not plan to use the roof box for a long period of time, store it away from direct sunlight, high temperature, and high humidity.

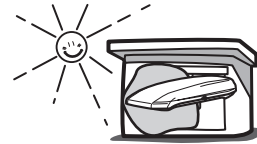

### Inspecting the Roof Box

- Inspect the roof box for cracks or damage. If you find any cracks or damage, discontinue using the roof box.
- Inspect the U-bolts and knobs for deformation or damage. If you find any deformation or damage, replace the part.
- Store small parts such as keys and installation brackets together in a plastic bag to ensure they are not lost.

## Information on genuine repair parts

The following genuine repair parts are available upon request. With the part number/part name, contact the dealer where you purchased this carrier.



Reference

- Specifications and external appearances of this carrier and genuine repair parts are subject to change without notice in the interest of product improvement.

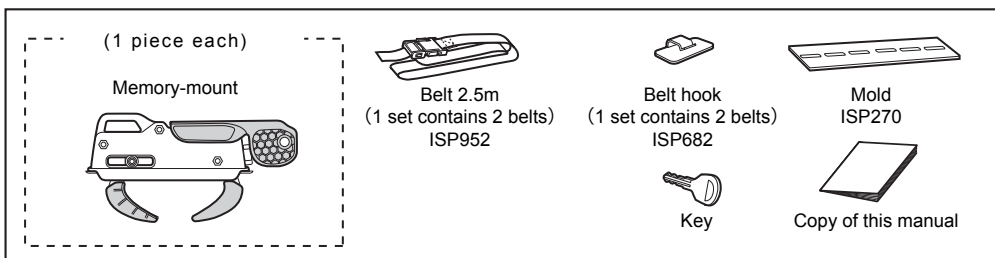

## Contact information

For questions and comments on this product, please contact the following service center. Car Mate USA shall not be held liable for any accidents or incidental losses arising from improper installation or use, from unauthorized alterations to the product.



CAR MATE USA, Inc  
383 Van Ness Ave. Suite 1603, Torrance, CA 90501 U.S.A  
support@innoracks.com www.innoracks.com

US-10