

# GENUS 27 PLUS



## Installation Instructions Type C Boilers

G.C.N: 47-116-11

LEAVE THESE INSTRUCTIONS  
WITH THE END USER

---



*The code of practice for the installation,  
commissioning & servicing of central heating systems*

# **TABLE OF CONTENTS**

## **1. GENERAL INFORMATION**

- 1.1 General Instructions
- 1.2 Overall View

## **2. INSTALLATION**

- 2.1 Delivery
- 2.2 Reference Standards
- 2.3 Siting the Appliance
- 2.4 Overall Dimensions
- 2.5 Clearances
- 2.6 Mounting the Appliance
- 2.7 Electrical Connection
- 2.8 Gas Connection
- 2.9 Water Connections
- 2.10 Flue Connection
- 2.11 Room Thermostat Connection
- 2.12 Electrical/System Diagrams
- 2.13 Water Circuit Diagrams

## **3. COMMISSIONING**

- 3.1 Initial Preparation
- 3.2 Removing the Casing
- 3.3 Control Panel
- 3.4 Initial Start-up
- 3.5 Operational Adjustments
- 3.6 Combustion Analysis
- 3.7 Fume Discharge Monitoring
- 3.8 Boiler Safety Systems
- 3.9 Draining the System

## **4. GAS ADJUSTMENTS**

- Gas Adjustment Table
- 4.1 Changing the Type of Gas

## **5. MAINTENANCE**

## **6. TECHNICAL INFORMATION**

# 1. GENERAL INFORMATION

This manual is an integral and essential part of the product. It should be kept with the appliance so that it can be consulted by the user and our authorised personnel.

Please carefully read the instructions and notices about the unit contained in this manual, as they provide important information regarding the safe installation, use and maintenance of the product.

For operating instructions please consult the separate User's Manual.



## 1.1 General Information

Read the instructions and recommendations in these Installation Instructions carefully to ensure proper installation, use and maintenance of the appliance.

Keep this manual in a safe place. You may need it for your own reference while our Servicing Centre technicians or your installer may need to consult it in the future.

The appliance should be left packed until it is ready to be installed, when handling the appliance be careful not to damage any controls or fittings.

This is a combined appliance for the production of central heating (C.H.) and domestic hot water (D.H.W.).

This appliance **must be used only** for the purpose for which it is designed. The manufacturer declines all liability for damage caused by improper or negligent use.

No asbestos or other hazardous materials have been used in the fabrication of this product.

**Before connecting** the appliance, check that the information shown on the data plate and the table on pages 4-5 comply with the electric, water and gas mains of the property. You will find the data plate on the reverse of the control panel. The gas with which this appliance operates is also shown on the label at the bottom of the boiler.

**Do not** install this appliance in a damp environment or close to equipment which spray water or other liquids.

**Do not place** objects on the appliance.

**Do not allow** children or inexperienced persons to use the appliance without supervision.

If you smell gas in the room, **do not turn on** light switches, use the telephone or any other object which might cause sparks.

Open doors and windows immediately to ventilate the room.

Shut the gas mains tap (on the gas meter) or the valve of the gas cylinder and call your Gas Supplier immediately.

If you are going away for a long period of time, remember to shut the mains gas tap or the gas cylinder valve.

**Always disconnect** the appliance either by unplugging it from the mains or turning off the mains switch before cleaning the appliance or carrying out maintenance.

**In the case of faults or failure**, switch off the appliance and turn off the gas tap. Do not tamper with the appliance.

For repairs, call your local Authorised Servicing Centre and request the use of original spare parts. For in-guarantee repairs contact MTS (GB) Limited

**Check** the following at least once a year:

- 1 - Check the seal of water connections, replacing the gaskets if necessary.
- 2 - Check the seal of the gas connections, replacing the gaskets if necessary.
- 3 - Check the general condition of the appliance and of the combustion chamber visually.

- 4 - Visual check of the combustion: clean burners if necessary.
- 5 - With reference to point 3, dismantle and clean the combustion chamber if necessary.
- 6 - With reference to point 4, dismantle and clean the injectors if necessary.
- 7 - Visual check of the primary heat exchanger:
  - check for overheating of the exchangers fins;
  - clean the exhaust side of the exchanger and fan if necessary.
- 8 - Regulate the gas pressure, ignition pressure, partial flame, maximum flame.
- 9 - Check proper operation of the heating safety system:
  - maximum safety temperature;
  - maximum safety pressure.
- 10 - Check the proper operation of the gas safety system:
  - gas or flame safety device;
  - gas valve safety device.
- 11 - Check that the electrical connections have been made in compliance with the instructions shown in the Installation Instructions.
- 12 - Check the efficiency of the hot water supply (flow and temperature).
- 13 - Check pressure in the Domestic Expansion Vessel and top up as necessary.
- 14 - Check manually by turning the test knob the Temperature & Pressure Relief Valve.
- 15 - Check manually by turning the test knob the Expansion Relief Valve.
- 16 - Check discharge pipes from both the central heating and domestic hot water for obstructions.
- 17 - Check general operation of the appliance.
- 18 - Check the exhaust system for the combustion products.

## 1.2 Overall View

### Legend:

1. Air Pressure Switch
2. Fan
3. Main Heat Exchanger
4. Combustion Chamber
5. Ignition Electrodes and Detection Electrodes
6. Burner
7. Automatic air release valve
8. Gas Valve
9. Spark Generator
10. Circulation Pump
11. Motorised Valve with by-pass
12. Main Circuit Flow Switch
13. Safety Valve (3 bar)
14. Low pressure switch
15. Expansion relief valve (6 bar)
16. C.H. expansion Vessel
17. D.H.W. expansion Vessel
18. Drain point
19. C.H.W. Probe
20. Overheat Thermostat
21. D.H.W. Storage with insulation shell

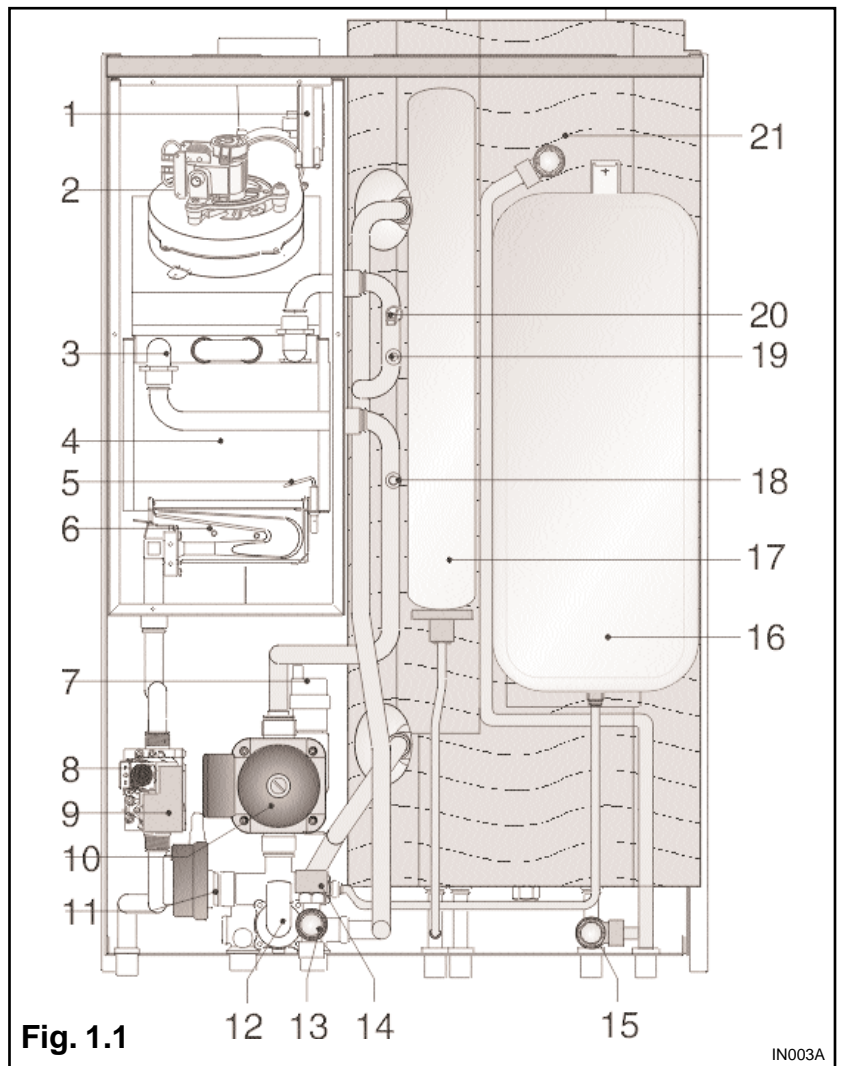

## 2. INSTALLATION

The technical information and instructions provided herein below are intended for the installer so that the unit may be installed correctly and safely.

### 2.1 Delivery

There will be three items:  
1 - The fully assembled boiler  
2 - A documentation bag  
3 - A separately boxed connection kit

### 2.2 Reference Standards

#### **WATER REGULATIONS**

These regulations ensure a good supply of wholesome water, and that only approved materials, pipes and fittings are used to convey water.

#### **BUILDING REGULATIONS**

These are a statutory document and take priority over all other regulations and recommendations. The installation of an unvented hot water storage cylinder is classified as a "Controlled Service" and Regulation G3 applies. To meet the requirements of the Regulation, installation of an unvented system should be undertaken by a "competent installer".

All installations of unvented hot water storage systems having a capacity of more than 15 litres should be notified to the relevant Local Authority by means of building notice or by the submission of full plans. It is important to note that it is a criminal offense to install an unvented hot water storage system without notifying the Local Authority.

The installation and initial startup of the boiler must be by a CORGI Approved Installer in compliance with the installation standards currently in effect, as well as with any and all local health and safety standards i.e. CORGI.

The installation of this appliance must be in accordance with the relevant requirements of the current Gas Safety (installation & use) Regulations, the Local Building Regulations, the current I.E.E. Wiring Regulations, the byelaws of the local water authority, and in Scotland, in accordance with the Building Standards (Scotland) Regulation and Health and Safety document No. 635 "Electricity at work regs. 1989". Installation should also comply with the following British Standard Codes of Practice:

<b>BS 7593:1992</b>	<b>Treatment of water in domestic hot water central heating systems</b>
<b>BS 5546:1990</b>	<b>Installation of hot water supplies for domestic purposes</b>
<b>BS 5440-1:1990</b>	<b>Flues</b>
<b>BS 5440-2:1989</b>	<b>Air supply</b>
<b>BS 5449:1990</b>	<b>Forced circulation hot water systems</b>
<b>BS 6789:1987</b>	<b>Installation of gas fired hot water boilers</b>
<b>BS 6891:1989</b>	<b>Gas installations</b>
<b>BS 7671:1992</b>	<b>IEE wiring regulations</b>
<b>BS 4814:1990</b>	<b>Specification for expansion vessels</b>
<b>BS 5482:1994</b>	<b>Installation of LPG</b>

### 2.3 Siting the Appliance

The appliance may be installed in any room or indoor area, although particular attention is drawn to the requirements of the current I.E.E. Wiring Regulations, and in Scotland, the electrical provisions of the Building Regulations applicable in Scotland, with respect to the installation of the combined appliance in a room containing a bath or shower.

**Where a room-sealed appliance is installed in a room containing a bath or shower the boiler and any electrical switch or appliance control, utilising mains electricity should be situated so that it cannot be touched by a person using the bath or shower.**

The location must permit adequate space for servicing and air circulation around the appliance as indicated in paragraph 2.4.

The location must permit the provision of an adequate flue and termination.

For unusual locations special procedures may be necessary.

BS 6798-1987 gives detailed guidance on this aspect.

A compartment used to enclose the appliance must be designed specifically for this purpose. No specific ventilation requirements are needed for an installation within a cupboard. This appliance is not suitable for outdoor installation.

***The type C appliances (in which the combustion circuit, air vent intake and combustion chamber are air-tight with respect to the room in which the appliance is installed) can be installed in any type of room.***

There are no limitations with respect to ventilation and the volume of the room itself. The boiler must be installed on a solid, permanent wall to prevent access to the electrical parts (when live) through the aperture on the back frame.

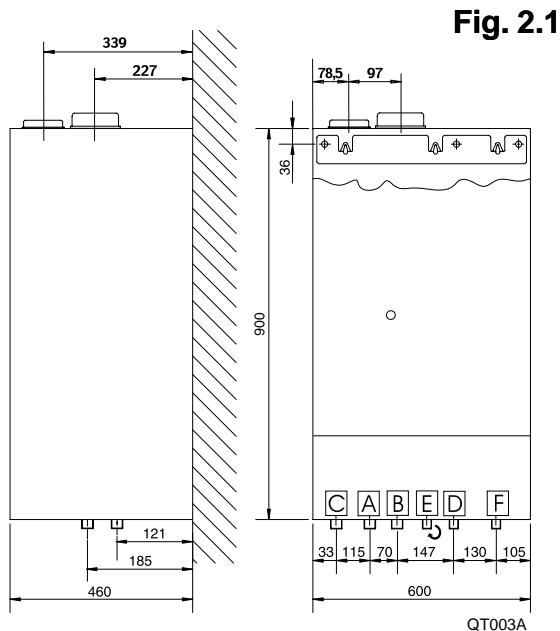

**Fig. 2.1**

## 2.4 Overall Dimensions

### Legend:

- A = Central Heating Return (3/4")
- B = Central Heating Flow (3/4")
- C = Gas Inlet (3/4")
- D = Domestic Hot Water Outlet (1/2")
- E = Secondary return (1/2")
- F = Domestic Cold Water Inlet (1/2")

## 2.5 Clearances

In order to allow for access to the interior of the boiler for maintenance purposes, the boiler must be installed in compliance with the clearance requirements indicated in the diagram below.

## 2.6 Mounting the Appliance

Fasten the boiler in place using the template and anchors supplied with the unit. It is highly recommended that a spirit level be used to position the boiler so that it is perfectly level. For additional information, please consult the instructions contained in the connection kit and the flue kit.

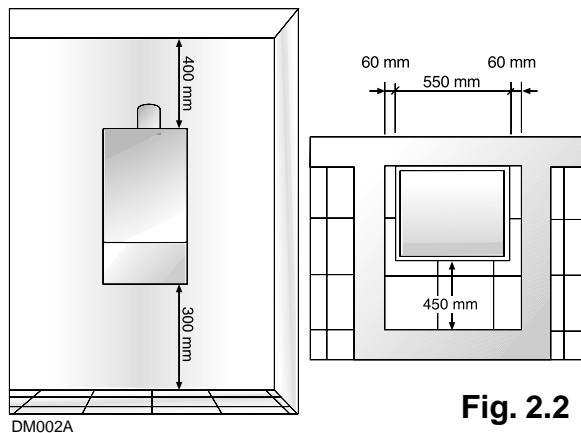
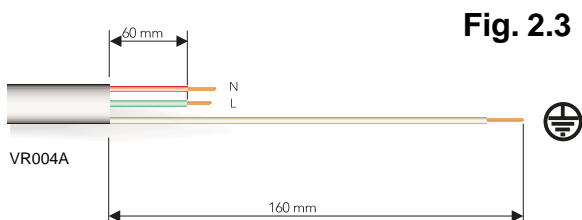

**Fig. 2.2**

## 2.7 Electrical Connection

For safety purposes, have a competent person carefully check the electrical system in the property, as the manufacturer will not be held liable for damage caused by the failure to earth the appliance properly or by anomalies in the supply of power. Make sure that the residential electrical system is adequate for the maximum power absorbed by the unit, which is indicated on the rating plate. In addition, check that the section of cabling is appropriate for the power absorbed by the boiler.

The boiler operates with alternating current, as indicated in the technical data table (7), where the maximum absorbed power is also indicated. Make sure that the connections for the neutral and live wires correspond to the indications in the diagram. The appliance electrical connections are situated on the reverse of the control panel (see the servicing manual for further information)



**Fig. 2.3**

### Important!

In the event that the power supply cord must be changed, replace it with one with the same specifications. Make the connections to the terminal board located within the control panel, as follows:

- The yellow-green wire should be connected to the terminal marked with the earth symbol; make sure to re-use the ferrule mounted on the other supply cord;
- The blue wire should be connected to the terminal marked "N";
- The brown wire should be connected to the terminal marked "L".

Note: The diagrams for the electrical system are indicated in section 2.12.

### Warning, this appliance must be earthed.

External wiring to the appliance must be carried out by a qualified technician and be in accordance with the current I.E.E. Regulations and applicable local regulations. The Genus range of boilers are supplied for connection to a 230 V~ 50 Hz supply.

### The supply must be fused at 3 A.

The method of connection to the electricity supply must facilitate complete electrical isolation of the appliance, by the use of a fused double pole isolator having a contact separation of at least 3 mm in all poles or alternatively, by means of a 3 A fused three pin plug and

unswitched shuttered socket outlet both complying with BS 1363.  
The point of connection to the Electricity supply must be readily accessible and adjacent to the appliance unless the appliance is installed in a bathroom when this must be sited outside the bathroom.

## 2.8 Gas Connection

The local gas region contractor connects the gas meter to the service pipe.  
If the gas supply for the boiler serves other appliances ensure that an adequate supply is available both to the boiler and the other appliances when they are in use at the same time.  
Pipe work must be of an adequate size. Pipes of a smaller size than the boiler inlet connection should not be used.

## 2.9 Water Connections

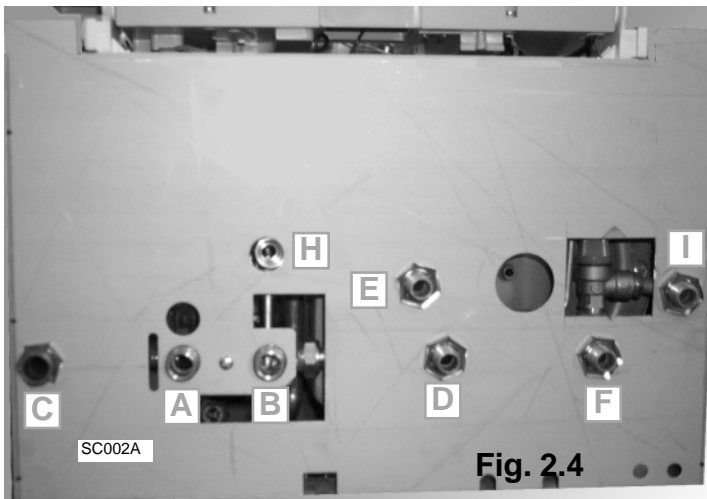

**View of the Boiler Connections**

**Legend:**

- A = Central Heating Return (3/4")
- B = Central Heating Flow (3/4")
- C = Gas Inlet (3/4")
- D = Domestic Hot Water Outlet (1/2")
- E = Secondary return (1/2")
- F = Domestic Cold Water Inlet (1/2")
- H = Central Heating Discharge
- I = Domestic Hot Water Discharge

**Central Heating**

Detailed recommendations are given in BS 6798:1987 and BS 5449-1:1990, the following notes are given for general guidance.

**Pipe Work:**

Copper tubing to BS EN 1057:1996 is recommended for water pipes. Jointing should be either with capillary soldered or compression fittings.

Where possible pipes should have a gradient to ensure air is carried naturally to air release points and water flows naturally to drain taps.

The appliance has a built-in automatic air release valve, however it should be ensured as far as possible that the appliance heat exchanger is not a natural collecting point for air.

Except where providing useful heat, pipes should be insulated to prevent heat loss and avoid freezing.

Particular attention should be paid to pipes passing through ventilated spaces in roofs and under floors.

**By-pass:**

The appliance includes an automatic by-pass valve, which protects the main heat exchanger in case of reduced or interrupted water circulation through the heating system, due to the closing of thermostatic valves or cock-type valves within the system.

**System Design:**

This boiler is suitable only for sealed systems.

**Drain Cocks:**

These must be located in accessible positions to permit the draining of the whole system. The taps must be at least 15mm nominal size and manufactured in accordance with BS 2870:1980.

**Safety Valve Discharge:**

The discharge should terminate facing downwards on the exterior of the building in a position where discharging (possibly boiling water & steam) will not create danger or nuisance, but in an easily visible position, and not cause damage to electrical components and wiring.

The discharge must not be over an entrance or a window or any other type of public access.

### Discharge pipework

- 1) The tundish must be installed directly below the discharge outlet connection of the boiler. The tundish must also be in a position visible to the occupants, and positioned away from any electrical devices. The discharge pipe from the tundish should terminate in a safe place where there is no risk to persons in the vicinity of the discharge and to be of metal.
- 2) Discharge pipes from the temperature & pressure relief are expansion relief valve are joined together within the appliance.
- 3) The pipe diameter must be at least one pipe size larger than the nominal outlet size of the safety device unless it's total equivalent hydraulic resistance exceeds that of a straight pipe 9m long.  
I.e. Discharge pipes between 9m and 18m equivalent resistance length should be at least 2 sizes larger than the nominal outlet size of the safety device. Between 18m and 27m at least 3 sizes larger, and so on.  
Bends must be taken into account in calculating the flow resistance.  
See fig. 2.4.1 and Table 1.
- 4) The discharge pipe must have a vertical section of pipe at least 300mm in length, below the tundish before any elbows or bends in the pipework.
- 5) The discharge pipe must be installed with a continuous fall.
- 6) The discharge must be visible at both the tundish and the final point of discharge, but where this is not possible or practically difficult; there should be clear visibility at one or other of these locations. Examples of acceptance are:
  - i) Ideally below a fixed grating and above the water seal in a trapped gully.
  - ii) Downward discharges at a low level; i.e. up to 100mm above external surfaces such as car parks, hard standings, grassed areas etc. These are acceptable providing that where children may play or otherwise come into contact with discharges, a wire cage or similar guard is positioned to prevent contact, whilst maintaining visibility.
  - iii) Discharges at high level; i.e. into a metal hopper and metal down pipe with the end of the discharge pipe clearly visible (tundish visible or not). Or onto a roof capable of withstanding high temperature discharges of water 3m from any plastic guttering systems that would take such a discharge (tundish visible).
  - iv) Where a single pipe serves a number of discharges, such as in blocks of flats, the number served should be limited to not more than 6 systems so that any installation can be traced reasonably easily. The single common discharge pipe should be at least one pipe size large than the largest individual discharge pipe to be connected. If unvented hot water storage systems are installed where discharges from safety devices may not be apparent i.e. in dwellings occupied by the blind, infirm or disabled people, consideration should be given to the installation of an electronically operated device to warn when discharge takes place.

Note: The discharge will consist of scalding water and steam. Asphalt, roofing felt and non-metallic rainwater goods may be damaged by such discharges.

**Warning**  
The outlet from the temperature & pressure relief valve must not be used for any other purpose.

The temperature & pressure relief valve must not be removed in any circumstances. Any of the above will totally invalidate the warranty.

**Note**  
The discharge from the central heating and domestic hot water systems may be joined together after the tundish.

**WORKED EXAMPLE**  
The example below is for a G 1/2 Temperature & Pressure Relief valve with a discharge pipe (D2) having 4 no. elbows and length of 7m from the Tundish to the point of discharge. From Table 1  
Maximum resistance allowed for a straight length of 22mm copper discharge pipe (D2) from G 1/2 T & P valve is 9m.  
Subtract the resistance for 4 no. 22mm elbows at 0.8m each = 3.2m.  
Therefore the maximum permitted length equates to: 5.8m.

As 5.8m is less than the actual length of 7m therefore calculate the next largest size.  
Maximum resistance allowed for a straight length of 28mm pipe (D2) from G 1/2 T & P valve equates to: 18m.  
Subtract the resistance for 4 no. 28mm elbow at 1.0m each = 4m.  
Therefore the maximum permitted length equates to: 14m  
As the actual length is 7m, a 28mm (D2) copper pipe will be satisfactory.

As 5.8m is less than the actual length of 7m therefore calculate the next largest size.  
Maximum resistance allowed for a straight length of 28mm pipe (D2) from G 1/2 T & P valve equates to: 18m.  
Subtract the resistance for 4 no. 28mm elbow at 1.0m each = 4m.  
Therefore the maximum permitted length equates to: 14m  
As the actual length is 7m, a 28mm (D2) copper pipe will be satisfactory.

As 5.8m is less than the actual length of 7m therefore calculate the next largest size.  
Maximum resistance allowed for a straight length of 28mm pipe (D2) from G 1/2 T & P valve equates to: 18m.  
Subtract the resistance for 4 no. 28mm elbow at 1.0m each = 4m.  
Therefore the maximum permitted length equates to: 14m  
As the actual length is 7m, a 28mm (D2) copper pipe will be satisfactory.

As 5.8m is less than the actual length of 7m therefore calculate the next largest size.  
Maximum resistance allowed for a straight length of 28mm pipe (D2) from G 1/2 T & P valve equates to: 18m.  
Subtract the resistance for 4 no. 28mm elbow at 1.0m each = 4m.  
Therefore the maximum permitted length equates to: 14m  
As the actual length is 7m, a 28mm (D2) copper pipe will be satisfactory.

As 5.8m is less than the actual length of 7m therefore calculate the next largest size.  
Maximum resistance allowed for a straight length of 28mm pipe (D2) from G 1/2 T & P valve equates to: 18m.  
Subtract the resistance for 4 no. 28mm elbow at 1.0m each = 4m.  
Therefore the maximum permitted length equates to: 14m  
As the actual length is 7m, a 28mm (D2) copper pipe will be satisfactory.

As 5.8m is less than the actual length of 7m therefore calculate the next largest size.  
Maximum resistance allowed for a straight length of 28mm pipe (D2) from G 1/2 T & P valve equates to: 18m.  
Subtract the resistance for 4 no. 28mm elbow at 1.0m each = 4m.  
Therefore the maximum permitted length equates to: 14m  
As the actual length is 7m, a 28mm (D2) copper pipe will be satisfactory.

As 5.8m is less than the actual length of 7m therefore calculate the next largest size.  
Maximum resistance allowed for a straight length of 28mm pipe (D2) from G 1/2 T & P valve equates to: 18m.  
Subtract the resistance for 4 no. 28mm elbow at 1.0m each = 4m.  
Therefore the maximum permitted length equates to: 14m  
As the actual length is 7m, a 28mm (D2) copper pipe will be satisfactory.

As 5.8m is less than the actual length of 7m therefore calculate the next largest size.  
Maximum resistance allowed for a straight length of 28mm pipe (D2) from G 1/2 T & P valve equates to: 18m.  
Subtract the resistance for 4 no. 28mm elbow at 1.0m each = 4m.  
Therefore the maximum permitted length equates to: 14m  
As the actual length is 7m, a 28mm (D2) copper pipe will be satisfactory.

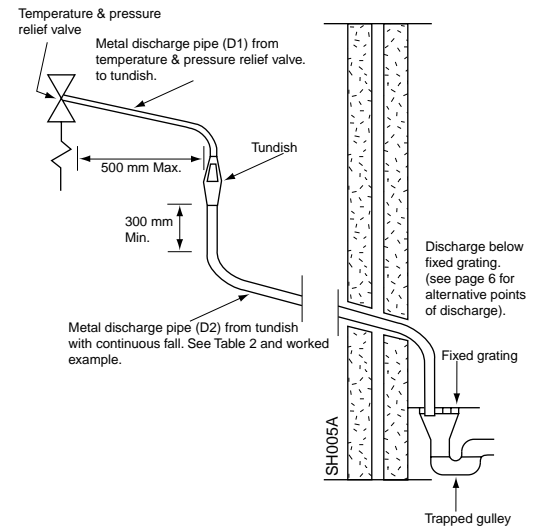

**Fig. 2.4.1**

**Table 1. Sizing of copper discharge pipe "D2" for common temperature valve outlet sizes.**

Valve outlet size	Minimum size of discharge pipe D1*	Minimum size of discharge pipe D2* from tundish	Maximum resistance allowed, expressed as a length of pipe (i.e. no elbow or bends)	Resistance created by each elbow or bend
G 1/2	15 mm	22 mm	Up to 9 m	0.8 m
		28 mm	Up to 18 m	1.0 m
		35 mm	Up to 27 m	1.4 m
G 3/4	22 mm	28 mm	Up to 9 m	1.0 m
		35 mm	Up to 18 m	1.4 m
		42 mm	Up to 27 m	1.7 m
G 1	28 mm	35 mm	Up to 9 m	1.4 m
		42 mm	Up to 18 m	1.7 m
		54 mm	Up to 27 m	2.3 m



**Air Release Points:**

These must be fitted at all high points where air naturally collects and must be sited to facilitate complete filling of the system.

The appliance has an integral sealed expansion vessel to accommodate the increase of water value when the system is heated.

It can accept up to 7 l (1.5 gal) of expansion water. If the heating circuit has an unusually high water content, calculate the total expansion and add an additional sealed expansion vessel with adequate capacity.

**Mains Water Feed - Central Heating:**

There must be no direct connection to the mains water supply even through a non-return valve, without the approval of the Local Water Authority.

**Filling:**

A temporary method for initially filling the system and replacing lost water during servicing and initial filling (complying to current water regulations and byelaws) must be provided. The flexible hose must be removed once the system has been filled.

**Domestic Water**

The domestic water must be in accordance with the relevant recommendation of BS 5546:1990. Copper tubing to BS EN 1057:1996 is recommended for water carrying pipe work and must be used for pipe work carrying drinking water. The domestic hot water temperature should be adjusted to trip at 60°C. This temperature will prevent the formation of limescale in hard water areas.

**Note: This appliance is capable of producing domestic hot water of up to 70°C. For extra security against scalding a thermostatic blending valve may be installed on the domestic hot water outlet.**

**Secondary Return**

The secondary return can be used as an option. A Non Return Valve (not supplied) must be fitted to prevent back flow and a Bronze Pump will be needed in conjunction with a Pipe Thermostat to circulate the hot water (both not supplied).

**Residual Head of the Boiler**

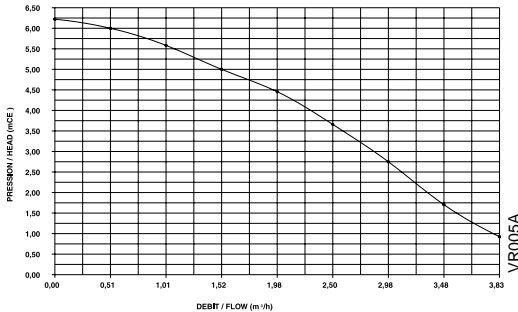

**Fig. 2.5**

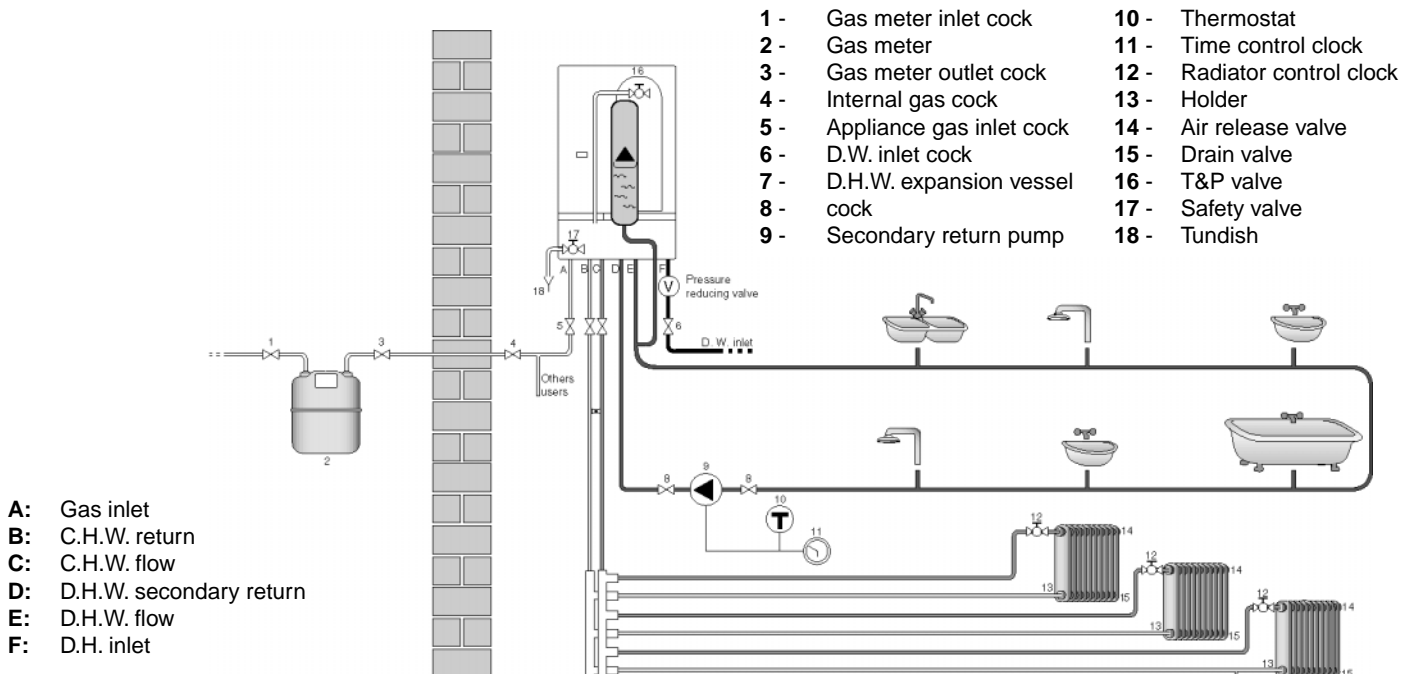

**Fig. 2.5.1**

## 2.10 Flue Connections

### Flue System

The provision for satisfactory flue termination must be made as described in BS 5440-1.

The appliance must be installed so that the flue terminal is exposed to outdoor air.

The terminal must not discharge into another room or space such as an outhouse or lean-to.

It is important that the position of the terminal allows a free passage of air across it at all times.

The terminal should be located with due regard for the damage or discolouration that might occur on buildings in the vicinity.

In cold or humid weather water vapour may condense on leaving the flue terminal.

The effect of such "steaming" must be considered.

If the terminal is less than 2 metres above a balcony, above ground or above a flat roof to which people have access, then a suitable terminal guard must be fitted. When ordering a terminal guard, quote the appliance model number.

A suitable terminal guard is available from:

### TOWER FLUE COMPONENTS

**Morley Road**

**Tonbridge**

**Kent TN9 1RA**

The minimum acceptable spacing from the terminal to obstructions and ventilation openings are specified in Fig. 2.6

The boiler is designed to be connected to a coaxial flue discharge system.

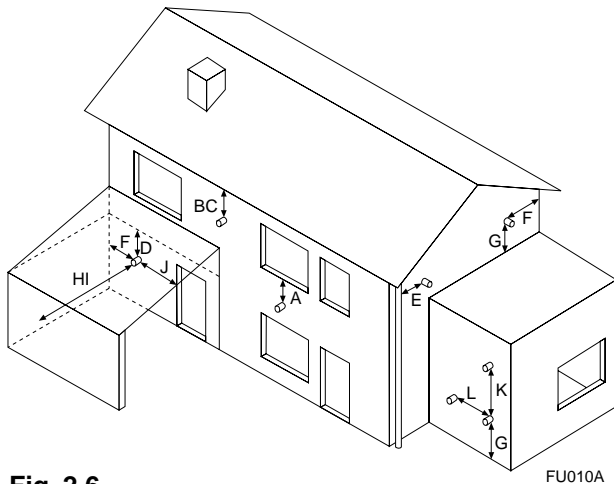

**Fig. 2.6**

TERMINAL POSITION	mm
A - Directly below an open window or other opening	300
B - Below gutters, solid pipes or drain pipes	75
C - Below eaves	200
D - Below balconies or car-port roof	200
E - From vertical drain pipes and soil pipes	75
F - From internal or external corners	300
G - Above ground or below balcony level	300
H - From a surface facing a terminal	600
I - From a terminal facing a terminal	1200
J - From an opening in the car port (e.g. door, window) into dwelling	1200
K - Vertically from a terminal in the same wall	1500
L - Horizontally from a terminal in the same wall	300

**Fig. 2.7**

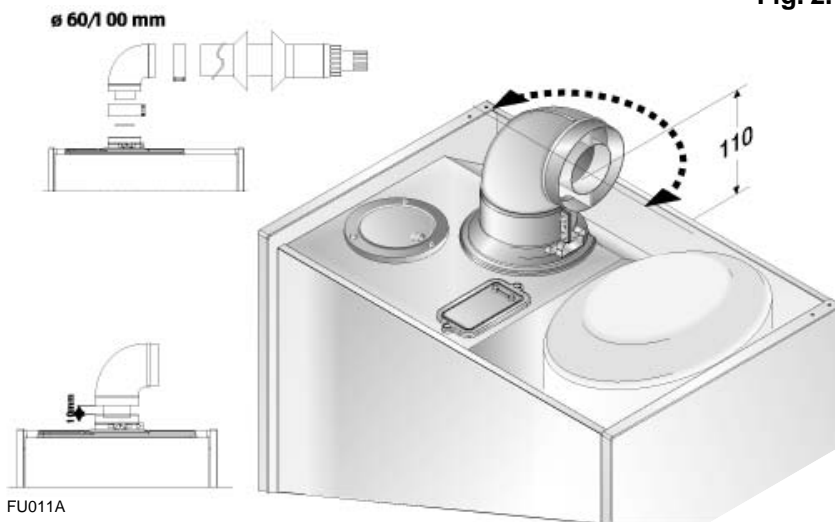

In addition, it is also possible to use a split system by fitting a special adapter to the flue discharge collar and using one of the apertures for the air vent intake located on the top part of the combustion chamber (A).

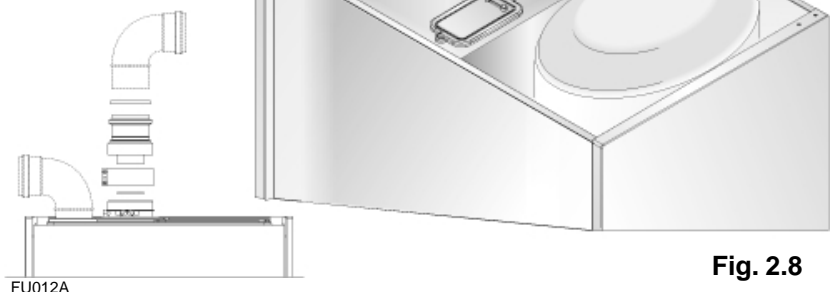

**Fig. 2.8**

FU013A

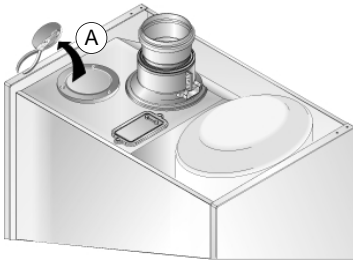

Fig. 2.9

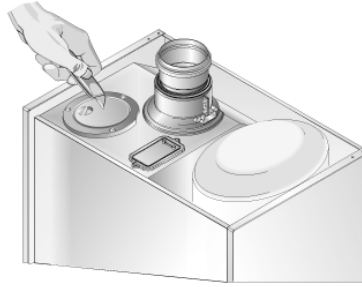

Fig. 2.10

- This procedure must be done as follows:
- 1 - Remove the air vent intake in the area indicated in Fig. 2.9, by breaking the perforated ring.
  - 2 - Use a tool to grasp the lid and remove it completely.
  - 3 - Clean any burrs or sharp edges with a knife or an appropriate tool.

In Fig. 2.11 below, several different types of flue systems are shown. For additional information regarding the flue accessories, please consult the Flue Pipe Accessories manual.

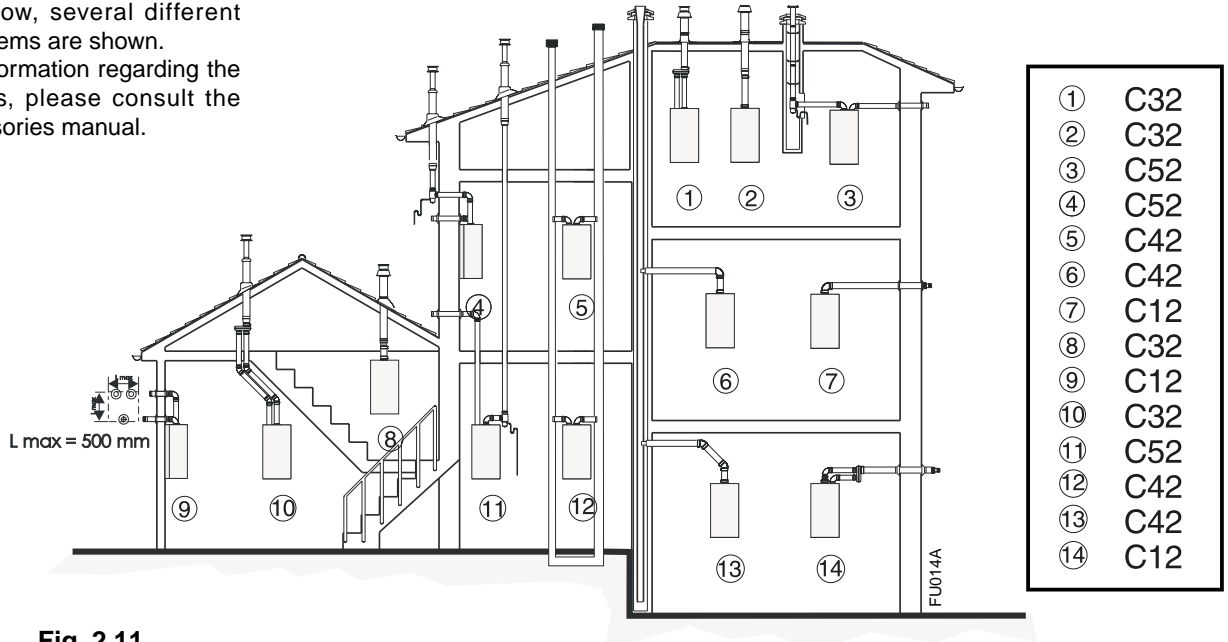

Fig. 2.11

	Exhaust Type	Maximum Extension Exhaust/Air	Diameter of Pipes (mm)	Use of $\varnothing$ 42 mm Restrictor on Delivery Side	Risk of Condensation Forming
Coaxial System	C12 (xx)	4 m	$\varnothing$ 60 /100	NO	
	C32 (xx)	4 m	$\varnothing$ 60 /100	NO	
	C42 (xx)	4 m	$\varnothing$ 60 /100	NO	
Split Systems	C12 (xy)	34 m	$\varnothing$ 80	L < 4.5 m	L > 6.6 m
	C32 (xy)	34 m	$\varnothing$ 80	L < 4.5 m	L > 6.6 m
	C42 (xy)	34 m	$\varnothing$ 80	L < 4.5 m	L > 6.6 m
	C52 (xy)	56 m	$\varnothing$ 80	L < 8 m	L > 5.8 m

(\*) L = Length of Piping

In calculating the lengths of the pipes, the maximum length must also take into consideration the values for the exhaust/air intake end terminals, as well as 90° elbows for coaxial systems.

The C52 types must comply with the following requirements:

1. The discharge/intake vent pipes must have the same diameter of  $\varnothing$  80 mm.
2. If an elbow is inserted into the discharge/ventilation system, the calculation of the overall extension must take into consideration the values for each curve, as indicated in the table.
3. The exhaust pipe must extend at least 0.5 m above the ridge of the roof if it is located on a side other than that for the air intake (this is not obligatory if the exhaust and air intake pipes are located on the same side of the building).

## 2.11 Room Thermostat Connection

In order to perform this procedure, remove the boiler casing as indicated in section 3.2. Then proceed as follows:

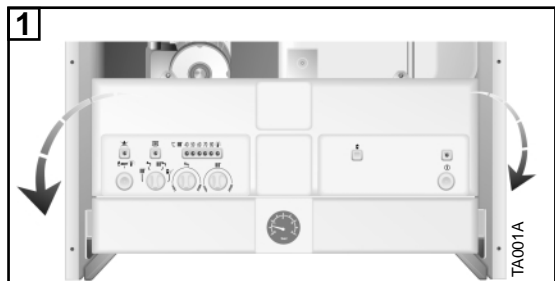

1 Rotate down the control panel.

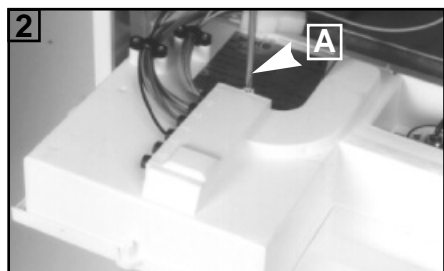

2 Open the cover "A" on the left hand side of the compartment.

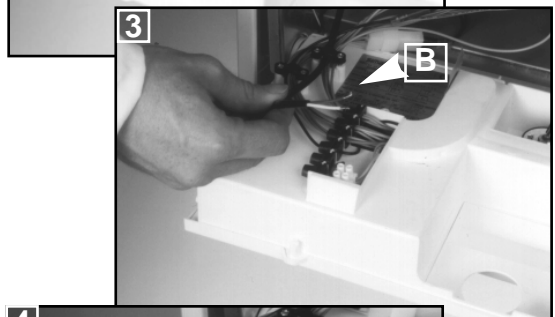

3 Insert the wire for the connection of the room thermostat into the cable clamp "B", as indicated in photo 3.

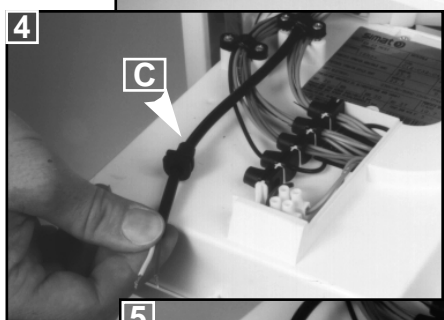

4 Remove the grommet "C" shown in the photo 4, make a hole in it and pass the room thermostat wire through.

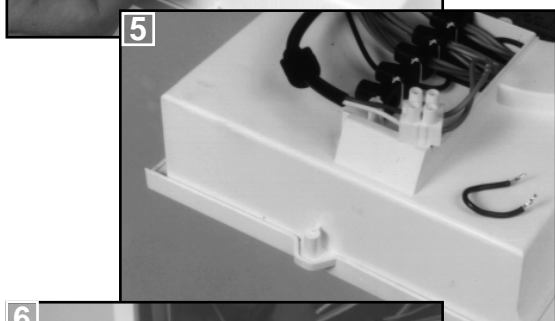

5 Remove the link located in the terminal block and connect the wire.

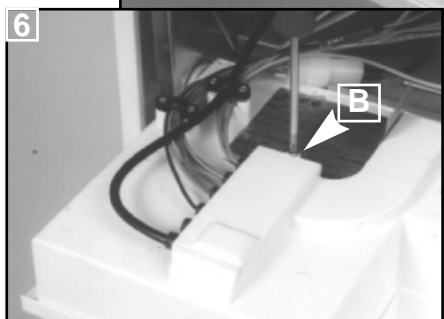

6 Replace the grommet and the terminal block to their original positions, close the cover on the grommet compartment and fasten the wire-clamp "B" in place.

7 If a remote time clock is to be fitted, disconnect the integral time clock plug from the P.C.B.

8 Using a volt-free switching time clock, connect the switching wires from the time clock following points 1-6 above.

9 If using a time clock and room thermostat, these must be connected in series as per points 1-8 above.

**Note:** Only a two-wire type room thermostat can be used.  
An anti-frost device is built-in to the appliance's electronic regulation system.

## 2.12 Electrical Diagram

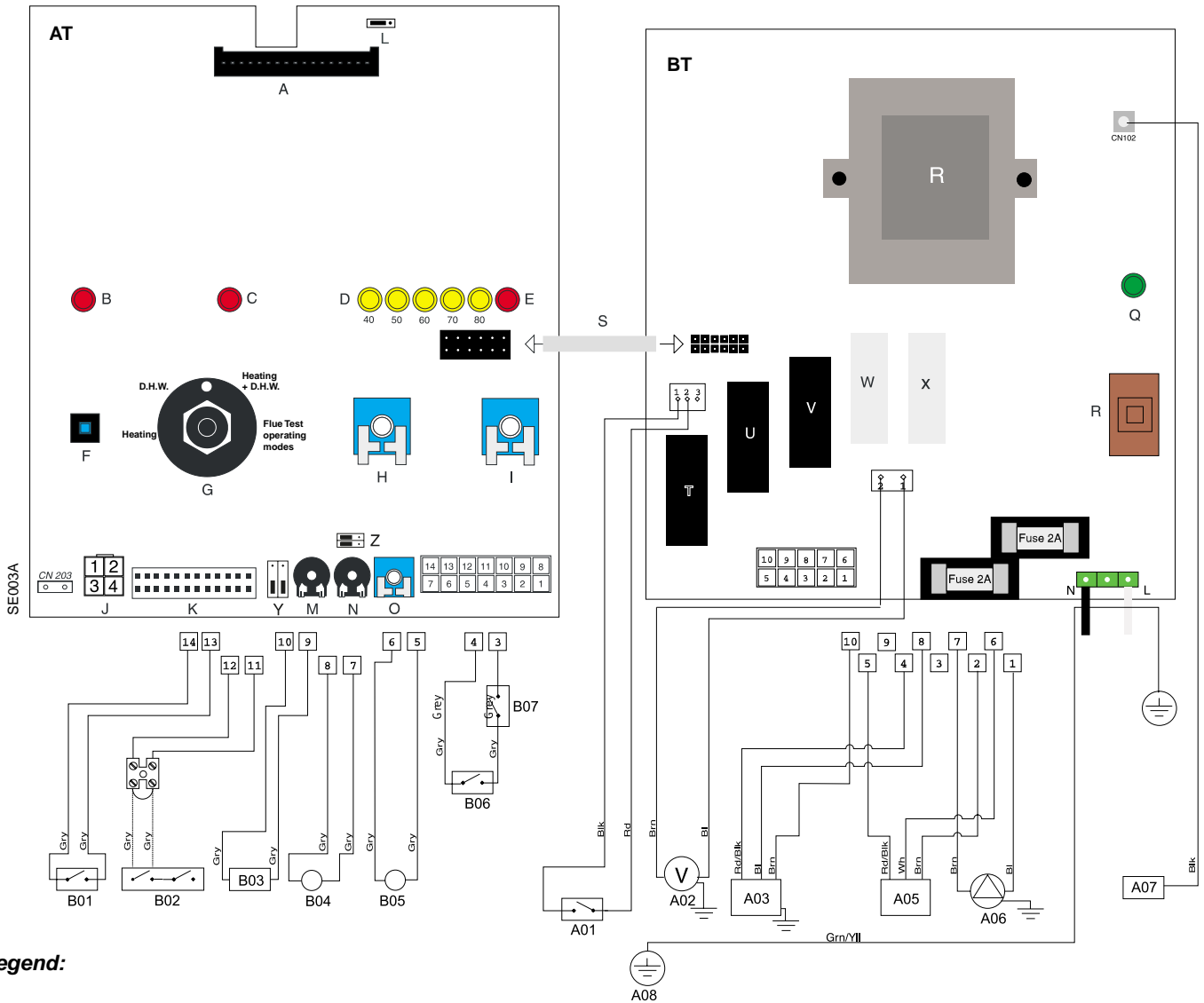

### Legend:

AT = High Voltage P.C.B.  
 BT = Low Voltage P.C.B.

A = Remote Connector Kit  
 B = Flame Failure L.E.D.  
 C = Insufficient Water Pressure L.E.D.  
 D = Water Temperature Indicator L.E.D.s  
 E = Overheat Thermostat Warning L.E.D.  
 F = System Reset Button  
 G = Selector Knob for Operating Mode  
 H = Domestic Hot Water Temp. Adjustment  
 I = Central Heating Temp. Adjustment  
 J = Wire Connector for Room Thermostat  
 K = Connector for Total Check System  
 L = Selector for Local/Remote Control  
 M = Anti-cycling Device Adjustment for Heating  
 N = Soft-light Adjustment  
 O = Max Heating Temperature Adjustment  
 P = Time Clock Connection  
 Q = On/Off L.E.D.  
 R = On/Off Switch  
 S = Interface Wire for P.C.B.s  
 T = Relay Motorised Valve  
 U = Ignitor Relay  
 V = Gas Valve Relay  
 W = Fan Relay  
 X = Circulation Pump Relay  
 Y = Selector TCS2  
 Z = Link for Continuous Pump Run

A01 = Air Pressure Switch  
 A02 = Fan  
 A03 = Gas Valve  
 A05 = Motorised Valve  
 A06 = Circulation Pump  
 A07 = Flame Detector  
 A08 = Earth Terminal

B01 = Over Heat Thermostat  
 B02 = External Thermostat  
 B03 = Gas Valve Modulator  
 B04 = D.H.W. Probe Sensor Cylinder  
 B05 = Heating Sensor  
 B06 = Pressure Switch for Heating Circuit  
 B07 = Minimum pressure switch

### Colours

Gry = Grey  
 Rd = Red  
 Bl = Blue  
 Grn/Yll = Yellow/Green  
 Wh = White  
 Brn = Brown  
 Blk = Black  
 Wh/Rd = White/Red

## 2.13 Water Circuit Diagram

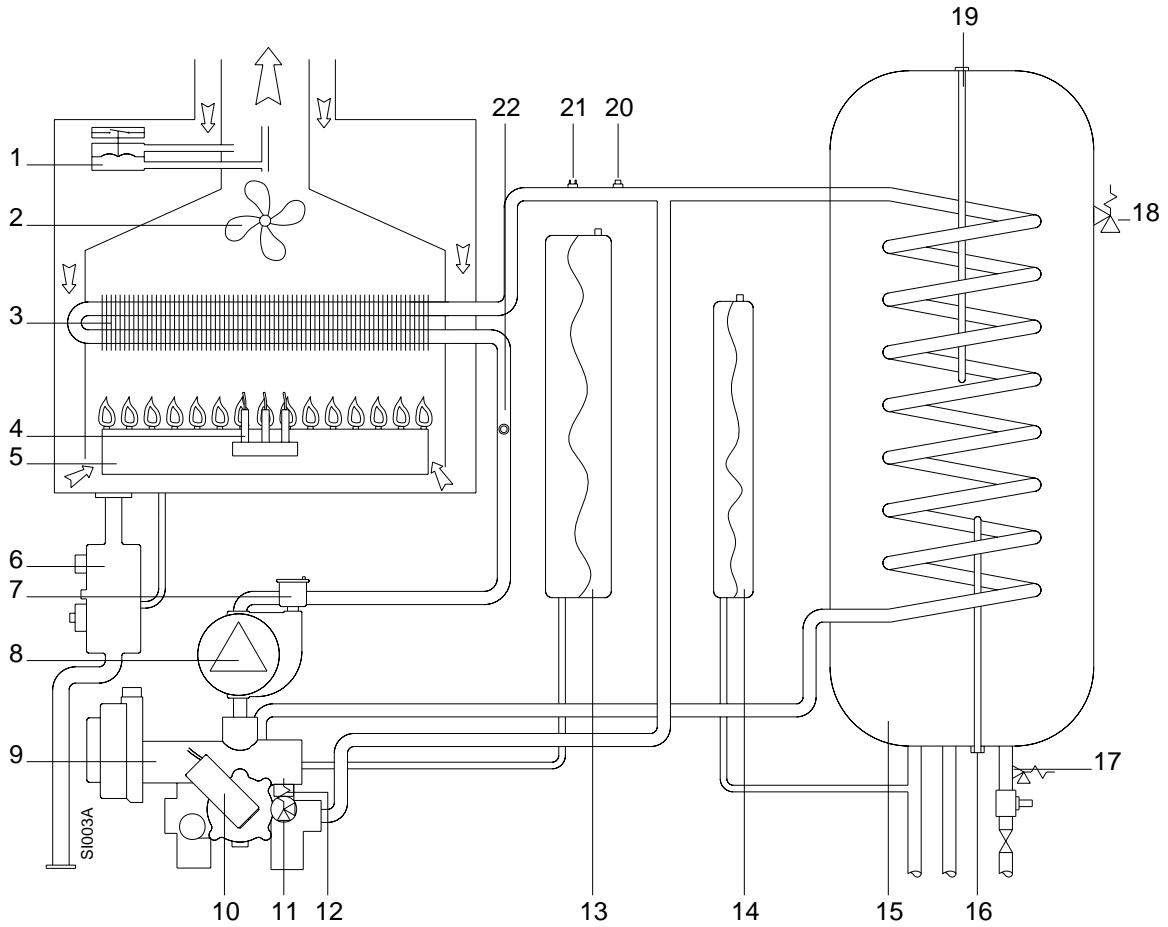

### Legend:

1. Air Pressure Switch
2. Fan
3. Main Heat Exchanger
4. Ignition Electrodes and Detection Electrodes
5. Burner
6. Gas Valve
8. Spark Generator
7. Automatic air release valve
8. Circulation Pump
9. Motorised Valve with by-pass
10. Main Circuit Flow Switch
11. Safety Valve (3 bar)
12. Low pressure switch
13. C.H. expansion Vessel
14. D.H.W. expansion Vessel
15. D.H.W. Storage with insulation shell
16. D.H.W. Probe
17. Expansion relief valve (6 bar)
18. Temperature/Pressure relief valve (7bar)
19. Magnesium anode
20. C.H.W. Probe
21. Overheat Thermostat
22. Drain point

## 3. COMMISSIONING

### 3.1 Initial Preparation

MTS (GB) Limited support the *benchmark* initiative. Within the information pack you will find a copy of the *benchmark* logbook. It is important that this is completed in the presence of your customer, they are shown how to use it, and it is signed by them. Please instruct your customer that they must have their *benchmark* logbook with them whenever they contact a service engineer or us.

Preliminary electrical system checks to ensure electrical safety must be carried out by a competent person i.e. polarity, earth continuity, resistance to earth and short circuit.

#### *Filling the Heating System:*

Remove the panels of the case and lower the control panel (see point 3.2. for further information). Open the central heating flow and return cocks supplied with the connection kit. Unscrew the cap on the automatic air release valve one full turn and leave open permanently. Close all air release valves on the central heating system. Gradually open valve(s) at the filling point (filling-loop) connection to the central heating system until water is heard to flow, do not open fully. Open each air release tap starting with the lower point and close it only when clear water, free of air, is visible.

**Purge the air from the pump by unscrewing anticlockwise the pump plug and also manually rotate the pump shaft in the direction indicated by the pump label to ensure the pump is free.**

Close the pump plug.

Continue filling the system until at least 1.5 bar registers on the pressure gauge. Inspect the system for water soundness and remedy any leaks discovered.

#### *Filling of the D.H.W. System:*

Close all hot water draw-off taps.

Open the cold water inlet cock supplied with the connection kit.

Open slowly each draw-off tap and close it only when clear water, free of bubbles, is visible

#### *Gas Supply:*

Inspect the entire installation including the gas meter, test for soundness and purge, all as described in BS 6891:1988.

Open the gas cock (supplied with the connection kit) to the appliance and check the gas connector on the appliance for leaks.

When the installation and filling are completed turn on the central heating system (sect. 3.4) and run it until the temperature has reached the boiler operating temperature. The system must then be immediately flushed through.

The flushing procedure must be in line with BS 7593:1992 Code of Practice for Treatment of Water in Domestic Hot Water Central Heating Systems.

During this operation, we highly recommend the use of a central heating flushing detergent (Ferox Superfloc or equivalent), whose function is to dissolve any foreign matter that may be in the system.

**Substances different from these could create serious problems to the pump or other components.**

The use of an inhibitor in system such as Ferox MB-1 or equivalent is strongly recommended to prevent corrosion (sludge) damaging the boiler and system.

**Failure to carry out this procedure may invalidate the appliance guarantee.**

### 3.2 Removing the Casing



### 3.3 Control Panel

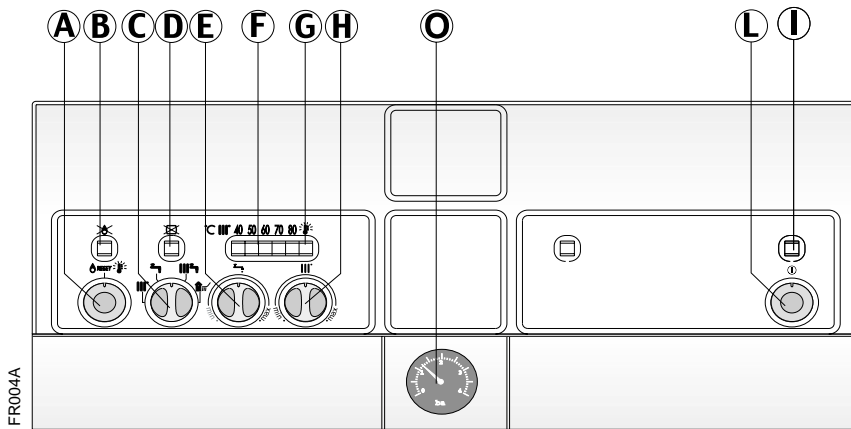

#### Legend:

- A** Ignition Failure Reset/Safety Thermostat Reset
- B** L.E.D. for Ignition Failure
- C** Selector Knob for Summer/Winter/Flue Test Modes
- D** L.E.D. for Insufficient System Pressure
- E** Domestic Hot Water Temperature Control
- F** Central Heating Temperature Indicating Leds
- G** L.E.D. for Safety Thermostat (overheating)
- H** Heating Temperature Adjustment Knob
- I** L.E.D. for ON/OFF Switch
- L** ON/OFF Switch
- O** Heating System Pressure Gauge

\* Warning the flue analysis mode must only be selected by a qualified service engineer.

### 3.4 Initial Start-up

**The checks to be run before initial start-up are as follows:**

1. Make sure that:
  - the screw on the automatic air valve has been loosened when the system is full;
  - If the water pressure in the system is below 1.5 bar, bring it up to the appropriate level;
  - Check to see whether the gas cock is closed;
  - Make sure that the electrical connection has been made properly and that the earth wire is connected to an efficient earthing system;
  - Supply power to the boiler by pressing the On/Off switch <L> - the L.E.D. "I" will turn on - turn the selector knob "C" to the <winter> setting. This will start the circulation pump. After 7 seconds, the boiler will signal a shut-down due to failure ignition. Leave the boiler as it is until all of the air has been bled from the lines.
  - Loosen the cap on the head of the pump to eliminate any air pockets;
  - Repeat the procedure for bleeding the radiators of air;
  - Open the taps for a brief period;
  - Check the system pressure and, if it has dropped, open the filling loop again to bring the pressure back up to 1.5 bar.
2. Check the exhaust flue for the fumes produced by combustion.
3. Make sure that all gate valves are open;
4. Turn on the gas cock and check the seals on the connections, including the one for the burner, making sure that the meter does not signal the passage of gas. Check the connections with a soap solution and eliminate any leaks.
5. Press the reset button "A" for the lighting system; the spark will light the main burner. If the burner does not light the first time, repeat the procedure.
6. Check the minimum and maximum pressure values for the gas going to the burner; adjust it if needed using the values indicated in the table in section 4. (See sect of the servicing manual).

### 3.5 Operational Adjustments

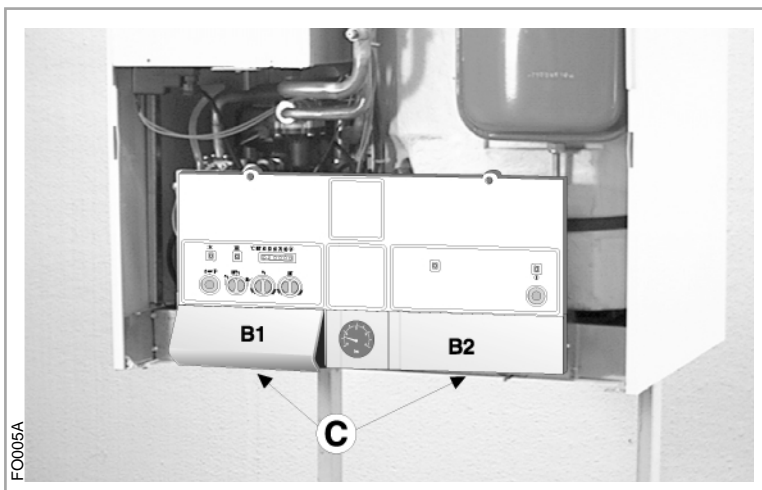

The boiler was designed to make regulation easy. To access the adjustment and control area, simply remove the cover by unscrewing the screws "A" and "C" and lift up the small service panels "B1" and "B2" respectively.

The first provides access to the control (low voltage) P.C.B., while the second makes it possible to work on the power supply P.C.B. The service panel "B2" also provides access to:

- the power supply cord connector;
- the fuses;
- the selector knob for continuous operation of the circulation pump.

The service panel "B1" also provides access to:

- the potentiometer for regulating the ignition delay (anti-cycling) feature, which can be set from 0 to 2 minutes (factory set at 1 minute);
- the potentiometer for regulating the soft-light feature, the set-



ting for which can range from the minimum thermal power to the maximum:

G20	5 mbar
G30-31	19 mbar

- the potentiometer for the maximum thermal power for the heating system, maximum thermal power setting (factory set at the maximum value, unless indicated otherwise on the adhesive sticker located in proximity to the potentiometer);
- The connection to the diagnosis device (TCS).

### 3.6 Combustion Analysis

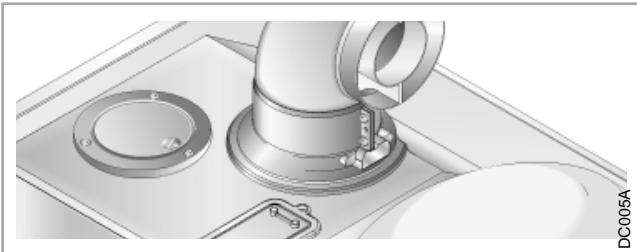

The boiler is designed to make it easy to analyse the combustion by-products.

Using the especially designed apertures, readings can be taken on the temperature of the combustion by-products and of the combustion air, as well as of the concentrations of O<sub>2</sub> and CO<sub>2</sub>, etc.

The best maximum-power test conditions for the heating system are when the selector "C" is turned to the flue analysis setting.

### 3.7 Fume Discharge Monitoring

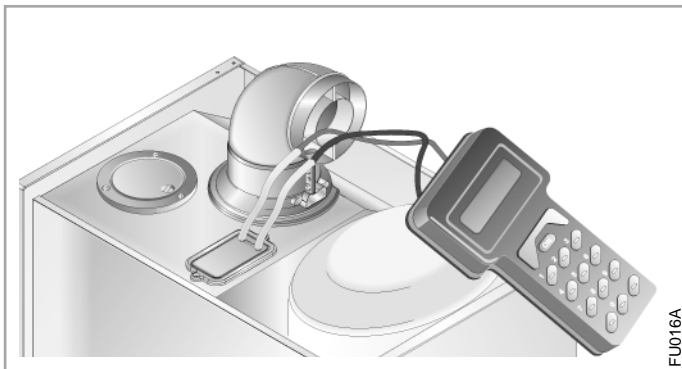

The discharge/ventilation of the exhaust fumes can be monitored to check for losses in general pressure in the system. This is done to eliminate the cause of lighting failure with the main burner not indicated by a shutdown status.

With a differential manometer connected to the test socket on the combustion chamber, the DP value for the air pressure switch can be taken. The measured value should not be less than 10 mbar under maximum thermal power conditions (with the knob "C" on the flue test setting) in order for the unit to function properly and without interruption.

### 3.8 Boiler Safety Systems

The boiler is equipped with the following safety systems (see section 3.3 for references):

#### 1. - Ignition Failure

This control signals an ignition failure on the burner 7 seconds after a lighting failure. The L.E.D. "B" will turn on to signal the shutdown status.

The system can be reset by pressing and releasing the button "A" after checking to make sure that the gas valve is open. Repeat this process until the burner lights.

#### 2. - Circulation Failure

This control signals that the safety pressure switch on the primary circuit has not sensed a pressure of at least 1.5 bar within 40 seconds of the activation of the circulation pump, it shuts off the boiler and lights the L.E.D. "D". The system can be reset (after the pressure has been brought up to the proper level) by using the On/Off switch "L".

#### 3. - Overheating

This control shuts off the boiler in the case where the primary circuit reaches a temperature in excess of 110°C. The L.E.D. "G" will come on to signal this shut-off status. After the system has been allowed to cool, the system can be reset by pressing the button "A".

#### 4. - Anti-frost Device

The boiler is equipped with a device that automatically lights the main burner when the temperature in the delivery line to the system drops below 5°C. The boiler will continue to operate until the temperature in question reaches about 58°C.

This device is activated on a properly operating boiler if:

- the system pressure is between the acceptable values;
- the power supply to the unit is on;
- the unit is supplied with gas.

This feature is enabled also when the boiler is in summer operating mode.

#### 5. - Safety Shut-off

At the start of every lighting phase, the P.C.B. performs a series of internal controls. If a malfunction occurs, the boiler will shutdown until the problem has been resolved.

### 3.9 Draining the System

#### *Draining the heating system.*

The heating system must be emptied as follows:

- Turn off the boiler;
- Open the drain valve for the system and place a container below to catch the water that comes out;
- Empty the system at the lowest points (where present). If you plan on not using the heating system for an extended period of time, it is recommended that you add antifreeze with an ethylene glycol base to the water in the heating lines and radiators if the ambient temperature drops below 0°C during the winter.

This makes repeated draining of the entire system unnecessary.

#### *Draining the domestic hot water system.*

Whenever there is the danger of the temperature dropping below the freezing point, the domestic hot water system must be drained as follows:

- Turn off the general water valve for the household plumbing system;
- Turn on all the hot and cold water taps;
- Empty the remaining water from the lowest points in the system (where present).

## 4. GAS ADJUSTMENTS

CATEGORY II2H3+		Methane Gas G20	Liquid Butane Gas G30	Liquid Propane Gas G31
Lower Wobbe Index (15°C;1013mbar)	MJ/m <sup>3</sup> h	45.67	80.58	70.69
Nominal Delivery Pressure	mbar	20	30	37
Minimum Delivery Pressure	mbar	17	20	25
<b>GENUS 27 BFFI PLUS</b>				
Main Burner: n. 15 jets (∅)	mm	1.25	0.72	0.72
Consumption (15°C; 1013mbar)	m <sup>3</sup> /h	3.16	----	----
Consumption (15°C; 1013mbar)	Kg/h	----	2.35	2.32
Gas Cock Outlet Pressure max - min	mbar	11.0- 2.0	(*) - 5.0	(*) - 7.0

(1mbar = 10,197column of water)

The outlet pressure of the gas cock is obtained by completely loosening the screw on the solenoid. The maximum pressure of the gas to the burner will be equal to the nominal delivery pressure minus the head loss within the gas valve.

### 4.1 Changing the Type of Gas

***The boiler can be converted to use either methane (natural) gas (G20) or LPG (G30 - G31) by an Authorised Service Centre.***

The operations that must be performed are the following:

1. Replace the jets on the main burner (see table in section 4);
2. Adjust the maximum and minimum thermal capacity values for the boiler (see table in section 4);
3. Replace the gas rating plate;
4. Adjust the maximum thermal power setting;

CATEGORY II2H3+	Methane Gas G20	Liquid Butane Gas G30	Liquid Propane Gas G31
Recommended Soft-light Pressure (mbar)	5-5.4	13.4	13.4

5. Adjust the soft-light feature;
6. Adjust the delayed lighting feature for the heating system (can be set from 0 to 2 mins.).

## **5. MAINTENANCE**

*It is recommended that the following checks be made on the boiler at least once a year:*

- 1 - Check the seals for the water connections; replacement of any faulty seals.
- 2 - Check the gas seals; replacement of any faulty gas seals.
- 3 - Visual check of the entire unit.
- 4 - Visual check of the combustion process and cleaning of the burners if needed.
- 5 - If called for by check no. 3, dismantling and cleaning of the combustion chamber.
- 6 - If called for by check no. 4, dismantling and cleaning of the injectors.
- 7 - Visual check of the primary heat exchanger:
  - check for overheating in the blade assembly;
  - clean the exhaust fan if needed.
- 8 - Adjustment of the flow rate of the gas: flow rate for lighting, partial load and full load.
- 9 - Check of the heating safety systems:
  - safety device for maximum temperature;
  - safety device for maximum pressure.
- 10 - Check of the gas safety systems:
  - safety device for lack of gas or flame ionisation (detection electrode);
  - safety device for gas cock.
- 11 - Check of the electrical connection (make sure it complies with the instructions in the manual).
- 12 - Check of domestic hot water production efficiency (delivery rate and temperature)
- 13 - Check pressure in the Domestic Expansion Vessel and top up as necessary.
- 14 - Check manually by turning the test knob the Temperature & Pressure Relief Valve.
- 15 - Check manually by turning the test knob the Expansion Relief Valve.
- 16 - Check discharge pipes from both the central heating and domestic hot water for obstructions.
- 17 - Check of the general performance of the unit.
- 18 - General check of the discharge/ventilation of the combustion by products.

## 6. TECHNICAL INFORMATION

		GENUS 27 BFFI PLUS
CE Certification		
Thermal Capacity	max/min kW	29.8/12.0
Thermal Power	max/min kW	27.4/10.3
Efficiency of Nominal Thermal Capacity	%	92.1
Efficiency at 30% of Nominal Thermal Capacity	%	88.8
Heat Loss to the Shell ( $\Delta=50^{\circ}\text{C}$ )	%	1.1
Flue Heat Loss with Burner Operating	%	6.8
Flue Heat Loss with Burner Off	%	0.4
Maximum Discharge of Fumes (methane)	Kg/h	56.9
Residual Discharge Head	mbar	1.3
Consumption at Nominal Capacity (G20-G25)	m <sup>3</sup> /h	3.16
(15°C, 1013 mbar) (G30-G31)	Kg/h	2.35/2.32
Temp. of Exhaust Fumes at Nominal Capacity with Methane	°C	136.9
CO <sub>2</sub> Content	%	7.27
O <sub>2</sub> Content	%	7.45
CO Content	ppm	55
Minimum Ambient Temperature	°C	+5
Heating Temperature	max/min °C	82/42
Temperature & Pressure Relief Valve Setting	bar/°C	7/90
Stored D.H.W. Cylinder Capacity	l	60
Stored D.H.W. min/max Temperature	max/min °C	40/70
Specific flow rate* (IN 10' $\Delta T=30^{\circ}\text{C}$ )	l/min	18
Time Taken to Raise Temperature from 15°C to 65°C**	min	12
Time Taken to Raise 70% of the Stored Volume to 65°C**	min	8
D.H.W. Expansion Vessel Capacity	l	3.5
D.H.W. Expansion Vessel Pre-load Charge	bar	3.5
Operating Pressure	bar	3.5
Maximum Supply Pressure to Pressure Reducing Valve	bar	16
Heating Expansion Vessel Capacity	l	7
Heating Expansion Vessel Pre-load Charge	bar	1
Maximum Water Content in System	l	145
Maximum Heating Pressure	bar	3
Nominal Pressure Natural Gas (G20)	mbar	20
LPG (G30-G31)	mbar	30-37
Electrical Supply	V/Hz	230 / 50
Power Consumption	W	200
Protection Grade of Electrical System	IP	X4D
Internal Fuse Rating		FAST 2 AT
Weight	Kg	86
<b>GC Number</b>		<b>47-116-11</b>

\*BS EN 625 \*\*Figures obtained by WRc in accordance with Test Criteria 1-50-220 & 1-50-222

Manufacturer: **Merloni TermoSanitari SpA - Italy**

Commercial subsidiary: **MTS (GB) LIMITED**

MTS Building  
Hughenden Avenue  
High Wycombe  
Bucks HP13 5FT

Telephone: (01494) 755600

Fax: (01494) 459775

Internet: <http://www.mtsgb.ltd.uk>

E-mail: [info@mtsgb.ltd.uk](mailto:info@mtsgb.ltd.uk)

**Technical Service Hot Line: (01494) 539579**

Cod. 23 99 84 1516 000

# GENUS 27 PLUS



## Users Manual



*The code of practice for the installation,  
commissioning & servicing of central heating systems*

Dear Customer,

Thank you for choosing an ARISTON boiler.

We guarantee that your boiler is a reliable and technically sound product.

This User's Manual provides detailed instructions and recommendations for proper installation, use and maintenance.

Remember to keep this manual in a safe place for future reference i.e. by the gas meter.

Your local MTS Servicing Centre is at your complete disposal for all requirements.

## MTS (GB) Limited

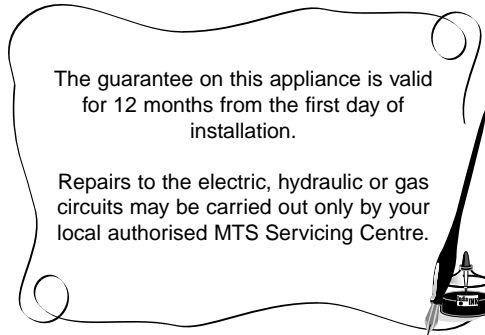

The guarantee on this appliance is valid for 12 months from the first day of installation.

Repairs to the electric, hydraulic or gas circuits may be carried out only by your local authorised MTS Servicing Centre.

*Every attempt has been made to avoid errors of any kind in this User's Manual, the Management invites customers to inform of any inaccuracies which they may find. This will help to improve our service*

## **IMPORTANT**

Please read this manual carefully.

For additional information, please consult the "Installation and Servicing Instructions."

Please ensure manuals provided are kept with the appliance so that they can be used by the end-user, installer or our authorised engineer.

## **TABLE OF CONTENTS**

<b>1) GENERAL INFORMATION</b>	<b>page 3</b>
<b>2) OPERATING INSTRUCTIONS</b>	<b>page 4</b>
<b>3) TIME CLOCK</b>	<b>page 7</b>
<b>4) USEFUL INFORMATION AND TROUBLESHOOTING</b>	<b>page 10</b>

# 1. GENERAL INFORMATION

MTS (GB) Limited support the *benchmark* initiative. Your installer will give you, and show you how to use, a logbook which will give you important information about your boiler, and heating system. Please have this logbook to hand whenever you contact a service engineer or us.

**All CORGI Registered Installers carry a CORGI ID card, and have a registration number. Both should be recorded in your boiler Logbook. You can check your installer is CORGI registered by calling CORGI direct on :- (01256) 372300.**

This is a combined appliance for the production of central heating (C.H.) and domestic hot water (D.H.W.). This appliance **must be used only** for the purpose for which it is designed. The manufacturer declines all liability for damage caused by improper or negligent use.

**Do not allow** children or inexperienced persons to use the appliance without supervision.

If you smell gas in the room, **do not turn on** light switches, use the telephone or any other object which might cause sparks.

Open doors and windows immediately to ventilate the room.

Shut the gas mains tap (on the gas meter) or the valve of the gas cylinder and call your Gas Supplier immediately.

If you are going away for a long period of time, remember to shut the mains gas tap or the gas cylinder valve.

**Before any intervention within the boiler it is first necessary to cut off the electrical power supply by turning the external switch to "OFF".**

**This manual may be kept in the front panel of the boiler.**

## CONTROL PANEL

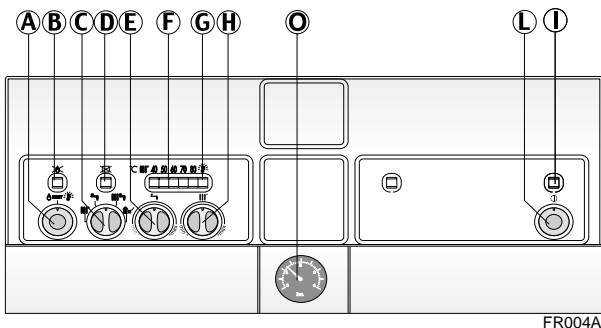

### Legend

- A) Ignition Lockout Reset Button/Safety (Overheat)Thermostat Reset
- B) Ignition Lockout L.E.D.
- C) Selector Knob for Summer/Winter/Flue Analysis Modes
- D) Low System Water Level L.E.D.
- E) Temperature Adjustment Knob for Domestic Hot Water
- F) Heating System Thermometer
- G) Safety (Overheat)Thermostat Intervention L.E.D.
- H) Adjustment Knob for Heating Temperature
- I) On/Off L.E.D.
- L) On/Off Switch
- O) Heating System Pressure Gauge

## 2. OPERATING INSTRUCTIONS

### CAUTION

*Installation, start-up, adjustments and maintenance must be performed by a competent person only, in accordance with the current Gas Safety (Installation & Use) Regulations and the instructions provided. Improper installation may cause damage or injury to individuals, animals and personal property, for which the manufacturer will not be held liable.*

*To ensure efficient and safe operation it is recommended that the boiler is serviced annually by a competent person.*

*If it is known or suspected that a fault exists on the appliance, it must not be used until the fault has been corrected by a competent person.*

### HELPFUL SUGGESTIONS

To get the most out of your boiler, we have provided you with some useful advice on the proper use and maintenance:

- Periodically check the system pressure using the pressure gauge "O", make sure that the pressure at 1.5 bar (the blue part on the gauge) when the system is off and cool. The warning L.E.D. "D" will indicate if the pressure is below the minimum recommended value. Consult your installer for checking and refilling the system.
- The outer panels of the unit's case must only be cleaned with a damp cloth. Do not use abrasive cleaners. The Control panel can be wiped with either a damp or dry cloth. Spray polishes must not be used on the control panel surface or knobs. Care must be taken in preventing any liquid entering the appliance.
- If the water is exceptionally hard, install a water softener so that the efficiency of the unit remains the same over time, as this will consume less gas.
- To improve comfort and take full advantage of the heat produced by the boiler, it is recommended that an external thermostat be installed.
- If the boiler is not going to be used for an extended period of time, turn off the supply of electricity to the unit by pressing the On/Off switch "L".
- The green L.E.D. "I" will turn off. Then turn off the supply of gas to the unit itself.
- It is good practice to clean and service the appliance and central heating system every year.
- Call an Authorised Service Centre.

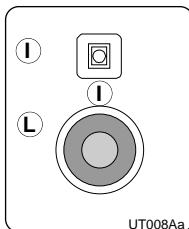
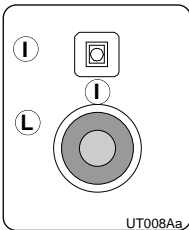

### START-UP PROCEDURE LIGHTING

Before starting the unit, check the following:

- The water pressure on the pressure gauge "O";
- That the gas cock and the inlet for domestic water are open.

These models are equipped with electronic ignition which utilises contact ionisation.

To make the boiler operational, simply press the On/Off switch "L".

The green L.E.D. "I" will then turn on.

At this point the boiler is ready for use: a centralised electronic control unit will automatically light the main burner when needed. If the burner



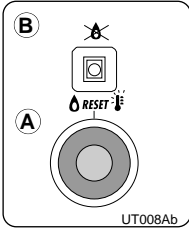

does not light within the pre-set safety time limit, the red “B” L.E.D. will light up. To reset the ignition system, the reset button “A” must be pressed. Should the system fail to light a second time, check to make sure that the gas cock is open. If the problem persists, contact one of our Authorised Service Centres for assistance.

## WINTER AND SUMMER OPERATING MODES

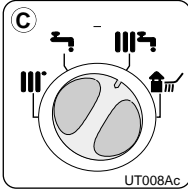

The boiler is fitted with a selector knob “C” which allows you to switch between winter < III' 2' > and summer < 2' > and also heating only < III' > operating modes and vice versa. When the knob is set to < III' 2' >, the boiler can serve the dual purpose of providing heat and/or hot water for domestic use.

The supply of hot water for domestic use always takes precedence over heating. When the knob is set to < 2' >, the boiler cuts out the heating system and only provides hot water for domestic use (when needed).

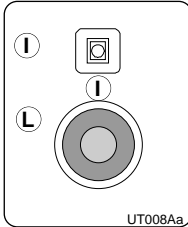

## TURNING ON THE CENTRAL HEATING

### Installation without a room thermostat :

- Turn on the power supply to the boiler by pressing the On/Off switch “L”; the green L.E.D. “I” will then turn on;
- Turn the “C” selector knob to < III' 2' > or < III' > (in this position no domestic hot water is produced);
- Regulate the temperature of the water in the boiler by turning the “H” knob. The temperature can vary between 42°C and about 82°C;
- Check the boiler temperature on the thermometer with the yellow L.E.D.s “F”. With this type of installation, the ambient temperature does not influence the operation of the boiler and the circulation pump always remains in operation.

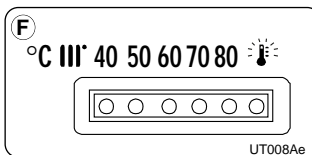
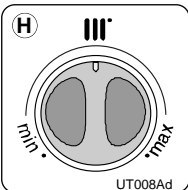
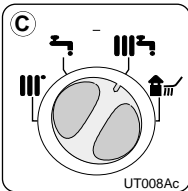

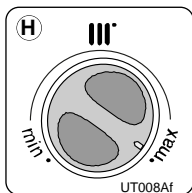

**Installation with a room thermostat:**

- Turn the “C” selector knob to < III' 2' >;
- Turn on the power supply to the boiler by pressing the On/Off switch “L”; the green L.E.D. will then turn on;
- Turn the thermostat knob “H” to the highest temperature setting.
- With this type of installation, the boiler is controlled by a room thermostat
- Therefore, it runs until the ambient temperature has reached the temperature setting on the thermostat. At that point, the main burner will turn off and the circulation pump will stop.

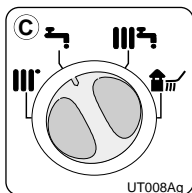

**TURNING OFF THE CENTRAL HEATING**

**Installation without a room thermostat:**

To turn off the heating, turn the “C” selector knob to < 2' >. The boiler will still provide hot water for domestic use.

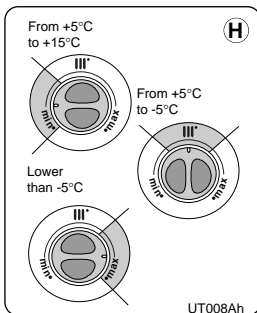

**ADJUSTING THE HEATING TEMPERATURE**

To economise on consumption while achieving the highest level of comfort, the temperature adjustment knob is designed with three different heating zones based on the temperature outside the home. Rotate the knob “H” as shown below.

**PRODUCTION OF HOT WATER FOR DOMESTIC USE**

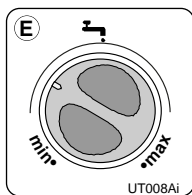

- Turn on the power to the boiler by pressing the On/Off switch “L”;
- Turn the “C” selector knob to < III' 2' > or < 2' > (in this position no central heating is produced);
- Turn the “E” knob to select the temperature for the hot water (between 40°C and about 70°C).

**ADJUSTING THE TEMPERATURE OF WATER FOR DOMESTIC USE**

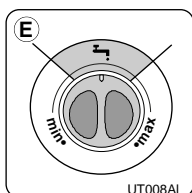

It is recommended that the temperature for the hot water should not be set to high temperatures and then mixed with cold water. Setting the thermostat to medium temperatures is preferable (see figure).

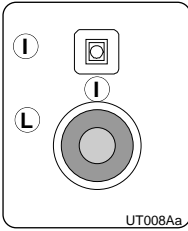

## SHUTDOWN PROCEDURE

To turn off the main burner, simply press the On/Off switch “L”; the green L.E.D. “I” will also turn off.

As a precautionary measure, it is recommended that the gas cock located on the bottom of the boiler be turned off as well.

## 3. TIME CLOCK

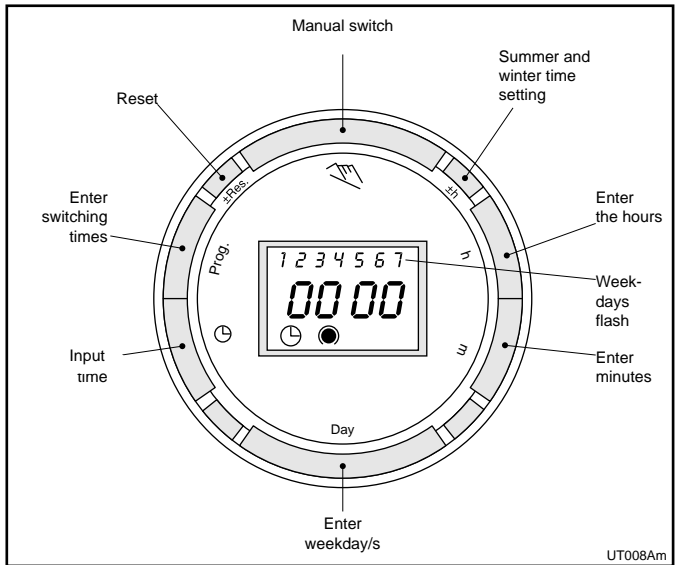

### Operating the time switch

The step marked with the symbol “▶” are necessary to carry out a switching program.

### Preparing for Operation

▶ Activate the “Res” switch (=RESET) to reset the time switch to its default setting (activate using a pencil or similar pointed instrument). Do this:

- every time you wish to “reset” the time switch
- to erase all switching times and the current time of day.

After approximately two seconds the following display appears:

### ▶ Enter current time and weekday

- Keep the “⌚” key pressed down
- During the summer time period press the +/- 1h key once.
- Enter the hour using the “h” key
- Enter the minutes using the “m” key
- Enter the day using the “Day” key
- 1 = “Monday”.....7 = Sunday
- Release the “⌚” key.

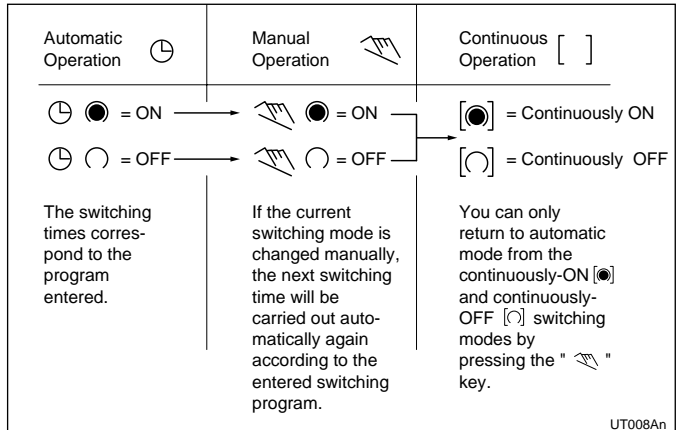



### ► Entering the switching times

You have 20 memory locations available. Each switching time takes up one memory location.

Keep pressing the "Prog" key until a free memory location is shown in the display "--:--".

Programme ON or OFF with the "" key:

"" = OFF; "" = ON

Enter the hour using "h"

Enter the minutes using "m"

If a switching command is to be carried out every day (1 2 3 4 5 6 7) then store using the "" key, otherwise select the day(s) it is to be carried out by using the "Day" key.

When the day selection is left blank, the programmed switching instruction operates at the same time every day

1 2 3 4 5 6 = Monday – Saturday



1 2 3 4 5 = Monday – Friday

6 7 = Saturday – Sunday

Selection of single days: 1 = Mon. .... 2 = Tues.

Save the switching time with the "" key.

The time switch enters the automatic operating mode and displays the current time of day.

Begin any further entry of a switching time with the "Prog" switch. If your entry is incomplete, the segments not yet selected will blink in the display. After programming is completed, and you return the time clock to the current time display with the "" key, the time clock will not activate any switching instruction required for the current time. You may need to manually select the desired switching state with the "" key. Thereafter, as the unit encounters further switching instructions in the memory in real time, it will correctly activate all subsequent switching instructions.

### Manual Override Switch ""

With the "" you can change the current setting at any time. The switching program already entered is not altered.

### Reading the programmed switching times

Pressing the "Prog" key displays the programmed switching times until the first free memory location appears in the display "-- : --".

If you now press the "Prog" key once again, the number of free memory locations will be displayed, e.g. "FR 18". If all memory locations are occupied, the display "FR 00" appears.

### Changing the programmed switching times

Press the "Prog" key repeatedly until the switching time you want to change is displayed. You can now enter the new data. See point "Entering the switching times".

#### Notes on storing switching times:

If you end your entry of the switching times by pressing the "Prog" key, then the switching time you have entered will be stored and the next memory location displayed. Entry of further switching times is also carried out as described in point 4.3.

In addition, a complete switching command is stored **automatically** after around 90 seconds provided **no other** key is pressed. The time switch then enters the automatic operating mode and displays the current time again.

#### Deleting individual switching times

Press the "Prog" key repeatedly until the switching time you wish to delete is shown in the display. Then set to "--" using the "h" or "m" key and keep the "⏻" key pressed down for around 3 seconds. The switching time is now erased and the current time is displayed.

#### AM / PM time display

If you press the "+/-1h" and "h" keys at the same time, the time display switches into the AM/PM mode (mostly used in English-speaking countries).

#### Technical data

Connection	see unit imprint
Switching capacity	see unit imprint
Ambient temperature	-10°C to +55°C
Running reserve	5 h at + 20°C
Memory locations	20
Shortest switching time	1 min.
Programmable	every minute

## 4. USEFUL INFORMATION AND TROUBLESHOOTING

### BOILER SHUTDOWN

The boiler unit is equipped with safety devices which intervene in certain situations to shutdown the boiler.

Some of these situations are signalled by the unit and can be corrected by the user.

#### SHUTDOWN DUE TO THE FAILURE OF THE BURNER TO LIGHT AUTOMATICALLY

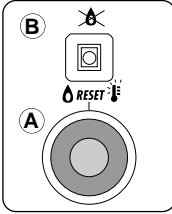

This anomaly is indicated by the red “B” L.E.D.

To reset the unit, press and then release the “A” button.

At this point, the electronic ignition system will attempt to light the burner again.

If lighting failure occurs repeatedly, it is recommended that you contact one of our Authorised Service Centres.

#### SHUTDOWN DUE TO OVERHEATING

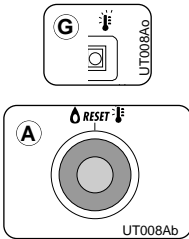

This anomaly is signalled by the red “G” L.E.D.

The boiler shuts off because the safety thermostat detected that the boiler temperature has reached the temperature limit.

To reset the unit, wait until the boiler has cooled and then press the “A” button.

If the safety thermostat shuts off the unit on a frequent basis, contact one of our Authorised Service Centres for assistance.

#### SHUTDOWN DUE TO INSUFFICIENT WATER CIRCULATION

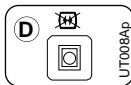
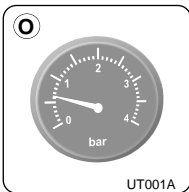

This anomaly is indicated by the red “D” L.E.D.

One of the possible causes of this shutdown situation could be the lack of water in the boiler or water circulation failure in the primary heating circuit.

Check the system pressure on the pressure gauge “O” and, if it is less than 0.5 bar, consult your installer for checking and refilling the system.

Then reset the unit by turning the boiler off and then back on with the On/Off button “L”.

If this situation persists, contact one of our Authorised Service Centres.

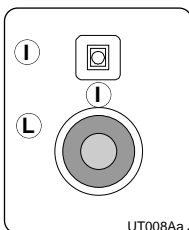

## **FLUE TEST FEATURE**

**(only for authorised personnel)**

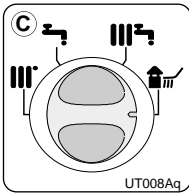

The “C” Summer/Winter/Flue Test selector knob can be set to < III > to bypass temperature adjustment on the heating circuit for the purpose of analysing the fumes produced by combustion.

To access this mode, open a water tap or taps so that the flow rate is no less than 8 litres per minute.

Then press the “C” selector knob in and turn it from < III > or < I > to the < II >.

### **WARNING!**

The flue test feature eliminates the slow-light feature.

**This mode must only be selected by a qualified service engineer.**

Manufacturer: **Merloni TermoSanitari SpA - Italy**

Commercial subsidiary: **MTS (GB) LIMITED**

MTS Building  
Hughenden Avenue  
High Wycombe  
Bucks HP13 5FT

Telephone: (01494) 755600

Fax: (01494) 459775

Internet: <http://www.mtsgb.ltd.uk>

E-mail: [info@mtsgb.ltd.uk](mailto:info@mtsgb.ltd.uk)

**Technical Service Hot Line: (01494) 539579**