

**MS4630B
Network Analyzer
Operation Manual
Vol.1
Panel Operation**

10th Edition

**For safety and warning information, please read this manual before attempting to use the equipment.
Keep this manual with the equipment.**

ANRITSU CORPORATION

Safety Symbols

To prevent the risk of personal injury or loss related to equipment malfunction, Anritsu Corporation uses the following safety symbols to indicate safety-related information. Ensure that you clearly understand the meanings of the symbols BEFORE using the equipment. Some or all of the following symbols may be used on all Anritsu equipment. In addition, there may be other labels attached to products that are not shown in the diagrams in this manual.

Symbols used in manual

DANGER  This indicates a very dangerous procedure that could result in serious injury or death if not performed properly.

WARNING  This indicates a hazardous procedure that could result in serious injury or death if not performed properly.

CAUTION  This indicates a hazardous procedure or danger that could result in light-to-severe injury, or loss related to equipment malfunction, if proper precautions are not taken.

Safety Symbols Used on Equipment and in Manual

The following safety symbols are used inside or on the equipment near operation locations to provide information about safety items and operation precautions. Ensure that you clearly understand the meanings of the symbols and take the necessary precautions BEFORE using the equipment.



This indicates a prohibited operation. The prohibited operation is indicated symbolically in or near the barred circle.



This indicates an obligatory safety precaution. The obligatory operation is indicated symbolically in or near the circle.



This indicates a warning or caution. The contents are indicated symbolically in or near the triangle.



This indicates a note. The contents are described in the box.



These indicate that the marked part should be recycled.

MS4630B

Network Analyzer

Operation Manual Vol.1 Panel Operation

10 November 1998 (First Edition)

17 December 2007 (10th Edition)

Copyright © 1998-2007, ANRITSU CORPORATION.

All rights reserved. No part of this manual may be reproduced without the prior written permission of the publisher.

The contents of this manual may be changed without prior notice.

Printed in Japan

For Safety

WARNING



1. ALWAYS refer to the operation manual when working near locations at which the alert mark shown on the left is attached. If the advice in the operation manual is not followed there is a risk of personal injury or reduced equipment performance. The alert mark shown on the left may also be used with other marks and descriptions to indicate other dangers.

2. IEC 61010 Standard

The IEC 61010 standard specifies four categories to ensure that an instrument is used only at locations where it is safe to make measurements. This instrument is designed for measurement category I (CAT I). DO NOT use this instrument at locations specified as category II, III, or IV as defined below.

Measurement category I (CAT I):

Secondary circuits of a device that is not directly connected to a power outlet.

Measurement category II (CAT II):

Primary circuits of a device that is directly connected to a power outlet, e.g., portable tools or home appliance.

Measurement category III (CAT III):

Primary circuits of a device (fixed equipment) to which power is supplied directly from the distribution panel, and circuits running from the distribution panel to power outlet.

Measurement category IV (CAT IV):

Building service-line entrance circuits, and circuits running from the service-line entrance to the meter or primary circuit breaker (distribution panel).

Electric Shock

3. To ensure that the instrument is earthed, always use the supplied 3-pin power cord, and insert the plug into an outlet with an earth terminal. If power is supplied without earthing the equipment, there is a risk of receiving a severe or fatal electric shock or causing damage to the internal components.

For Safety

WARNING

Repair

WARNING 

Calibration



Falling Over

Battery Fluid

LCD

4. This equipment cannot be repaired by the operator. DO NOT attempt to remove the equipment covers or unit covers or to disassemble internal components. Only qualified service personnel with a knowledge of electrical fire and shock hazards should service this equipment. There are high-voltage parts in this equipment presenting a risk of severe injury or fatal electric shock to untrained personnel. In addition, there is a risk of damage to precision components.
5. The performance-guarantee seal verifies the integrity of the equipment. To ensure the continued integrity of the equipment, only Anritsu service personnel, or service personnel of an Anritsu sales representative, should break this seal to repair or calibrate the equipment. If the performance-guarantee seal is broken by you or a third party, the performance of the equipment cannot be guaranteed. Be careful not to break the seal by opening the equipment or unit covers.
6. This equipment should always be positioned in the correct manner. If the cabinet is turned on its side, etc., it will be unstable and may be damaged if it falls over as a result of receiving a slight mechanical shock.
Always set up the equipment in a position where the power switch can be reached without difficulty.
7. DO NOT short the battery terminals and never attempt to disassemble the battery or dispose of it in a fire. If the battery is damaged by any of these actions, the battery fluid may leak. This fluid is poisonous. DO NOT touch the battery fluid, ingest it, or get in your eyes. If it is accidentally ingested, spit it out immediately, rinse your mouth with water and seek medical help. If it enters your eyes accidentally, do not rub your eyes, rinse them with clean running water and seek medical help. If the liquid gets on your skin or clothes, wash it off carefully and thoroughly.
8. This instrument uses a Liquid Crystal Display (LCD). DO NOT subject the instrument to excessive force or drop it. If the LCD is subjected to strong mechanical shock, it may break and liquid may leak. This liquid is very caustic and poisonous. DO NOT touch it, ingest it, or get in your eyes. If it is ingested accidentally, spit it out immediately, rinse your mouth with water and seek medical help. If it enters your eyes accidentally, do not rub your eyes, rinse them with clean running water and seek medical help. If the liquid gets on your skin or clothes, wash it off carefully and thoroughly.

For Safety

CAUTION

Fuse Replacement

CAUTION 

1. Always remove the mains power cable from the power outlet before replacing blown fuses. There is a risk of electric shock if fuses are replaced with the power cable connected. Always use new fuses of the type and rating specified on the rear panel of the instrument. There is a risk of fire if a fuse of a different rating is used.

T5.0A indicates a time-lag fuse.

Cleaning

2. Keep the power supply and cooling fan free of dust.
 - Clean the power inlet regularly. If dust accumulates around the power pins, there is a risk of fire.
 - Keep the cooling fan clean so that the ventilation holes are not obstructed. If the ventilation is obstructed, the cabinet may overheat and catch fire.



3. NEVER touch parts to which the label shown on the left is attached. These parts are hotter than 55°C and there is a risk of receiving a burn.

Check Terminal



4. Never input a signal of more than the indicated value between the measured terminal and ground. Input of an excessive signal may damage the equipment.

For Safety

CAUTION

Replacing Memory Back-up Battery

This equipment uses a Poly-carbomonofluoride lithium battery to backup the memory. This battery must be replaced by service personnel when it has reached the end of its useful life; contact the Anritsu sales section or your nearest representative.

Note: The battery used in this equipment has a maximum useful life of 7 years. It should be replaced before this period has elapsed.

External Storage Media

This equipment uses memory cards as external storage media for storing data and programs.

If this media is mishandled or becomes faulty, important data may be lost. To prevent this chance occurrence, all important data and programs should be backed-up.

Anritsu will not be held responsible for lost data.

Pay careful attention to the following points.

- Never remove the memory card from the instrument while it is being accessed.
- The memory card may be damaged by static electric charges.
- The back-up battery in SRAM memory cards has a finite life. Replace the battery periodically. For details, refer to the explanation on the memory card later in this manual.
- Anritsu has thoroughly tested all external storage media shipped with this instrument. Users should note that external storage media not shipped with this instrument may not have been tested by Anritsu, thus Anritsu cannot guarantee the performance or suitability of such media.

Use in a residential environment

This instrument is designed for an industrial environment.

In a residential environment this instrument may cause radio interference in which case the user may be required to take adequate measures.

Equipment Certificate

Anritsu Corporation certifies that this equipment was tested before shipment using calibrated measuring instruments with direct traceability to public testing organizations recognized by national research laboratories, including the National Institute of Advanced Industrial Science and Technology, and the National Institute of Information and Communications Technology, and was found to meet the published specifications.

Anritsu Warranty

Anritsu Corporation will repair this equipment free-of-charge if a malfunction occurs within one year after shipment due to a manufacturing fault, under the condition that this warranty is void when:

- The fault is outside the scope of the warranty conditions described in the operation manual.
- The fault is due to mishandling, misuse, or unauthorized modification or repair of the equipment by the customer.
- The fault is due to severe usage clearly exceeding normal usage.
- The fault is due to improper or insufficient maintenance by the customer.
- The fault is due to natural disaster including fire, flooding, earthquake, etc.
- The fault is due to use of non-specified peripheral equipment, peripheral parts, consumables, etc.
- The fault is due to use of a non-specified power supply or in a non-specified installation location.

In addition, this warranty is valid only for the original equipment purchaser. It is not transferable if the equipment is resold.

Anritsu Corporation shall assume no liability for injury or financial loss of the customer due to the use of or a failure to be able to use this equipment.

Anritsu Corporation Contact

In the event that this equipment malfunctions, contact an Anritsu Service and Sales office. Contact information can be found on the last page of the printed version of this manual, and is available in a separate file on the CD version.

Notes On Export Management

This product and its manuals may require an Export License/Approval by the Government of the product's country of origin for re-export from your country.

Before re-exporting the product or manuals, please contact us to confirm whether they are export-controlled items or not.

When you dispose of export-controlled items, the products/manuals need to be broken/shredded so as not to be unlawfully used for military purpose.

Crossed-out Wheeled Bin Symbol

Equipment marked with the Crossed-out Wheeled Bin Symbol complies with council directive 2002/96/EC (the “WEEE Directive”) in European Union.



For Products placed on the EU market after August 13, 2005, please contact your local Anritsu representative at the end of the product's useful life to arrange disposal in accordance with your initial contract and the local law.

CE Conformity Marking

Anritsu affixes the CE conformity marking on the following product(s) in accordance with the Council Directive 93/68/EEC to indicate that they conform to the EMC and LVD directive of the European Union (EU).

CE marking



1. Product Model

Model: MS4630B Network Analyzer

2. Applied Directive

EMC: Directive 2004/108/EC

LVD: Directive 2006/95/EC

3. Applied Standards

- EMC: Emission: EN 61326-1: 2006 (Class A)
Immunity: EN 61326-1: 2006 (Table 2)

	Performance Criteria*
IEC 61000-4-2 (ESD)	B
IEC 61000-4-3 (EMF)	A
IEC 61000-4-4 (Burst)	B
IEC 61000-4-5 (Surge)	B
IEC 61000-4-6 (CRF)	A
IEC 61000-4-8 (RPFMF)	A
IEC 61000-4-11 (V dip/short)	B, C

*: Performance Criteria

A: During testing, normal performance within the specification limits.

B: During testing, temporary degradation, or loss of function or performance which is self-recovering.

C: During testing, temporary degradation, or loss of function or performance which requires operator intervention or system reset occurs.

Harmonic current emissions:

EN 61000-3-2: 2006 (Class A equipment)

- LVD: EN 61010-1: 2001 (Pollution Degree 2)

4. Authorized representative

Name: Loic Metais
European Quality Manager
ANRITSU S.A. France

Address, city: 16/18 Avenue du Québec SILIC 720 Zone de
Courtaboeuf
91951 Les Ulis Cedex

Country: France

C-tick Conformity Marking

Anritsu affixes the C-tick mark on the following product(s) in accordance with the regulation to indicate that they conform to the EMC framework of Australia/New Zealand.

C-tick marking



1. Product Model

Model: MS4630B Network Analyzer

2. Applied Standards

EMC:Emission: EN 61326-1: 2006 (Class A equipment)

Power Line Fuse Protection

For safety, Anritsu products have either one or two fuses in the AC power lines as requested by the customer when ordering.

Single fuse: A fuse is inserted in one of the AC power lines.

Double fuse: A fuse is inserted in each of the AC power lines.

Example 1: An example of the single fuse is shown below:

Fuse Holder

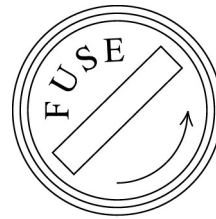

Example 2: An example of the double fuse is shown below:

Fuse Holders

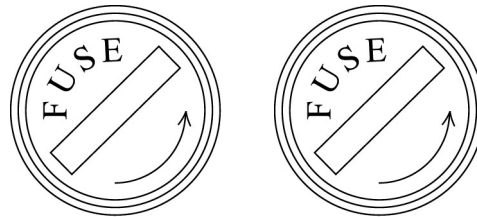

About This Manual

Lineup of Operation Manuals

Two different Operation Manuals (Vol. 1 and Vol. 2) come standard with the MS4630B. Refer to these manuals as required.

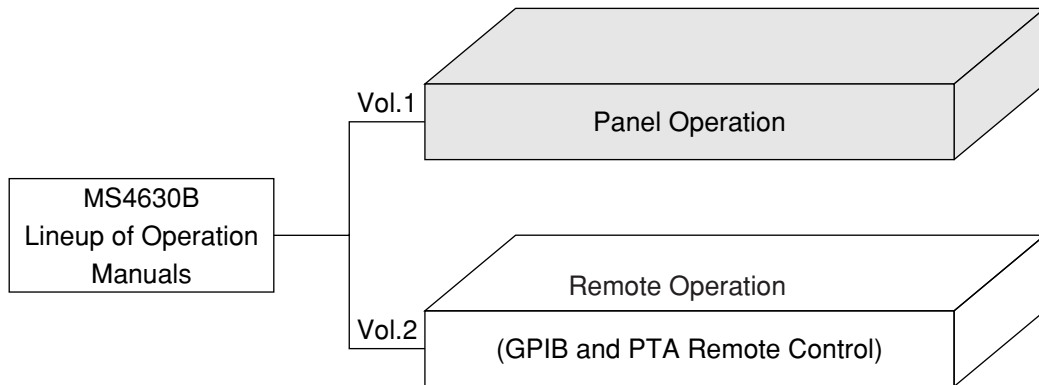

Panel Operation:

This manual provides general information about the MS4630B and detailed information about preparations before use, and panel operations excluding automatic measurement such as performance tests.

Remote Operation (GPIB Control and PTA Control):

This manual explains IEEE488.2-based GPIB remote control as the MS4630B conforms to IEEE488.2.

This manual also explains PTA, a function for programming high-speed control and processing using a high-level language PTL. It is performed by the personal computer incorporated in the MS4630B, promoting automatic measurement along with the GPIB.

Table of Contents

For Safety	iii
About This Manual	I
Section 1 Introduction	1-1
1.1 Product Overview	1-2
1.2 Organization of This Manual	1-3
1.3 System Configuration	1-4
1.4 Application Parts and Peripheral Devices	1-5
1.5 Specifications	1-6
Section 2 Preparations before Use	2-1
2.1 Environmental Conditions of Installation Site	2-2
2.2 Safety Measures	2-3
2.3 Mounting on a Rack and Stacking with Other Units	2-6
2.4 Preparations to Make before Turning ON the Power	2-7
2.5 Notes on Handling Storage Medium	2-10
Section 3 Basic Operations	3-1
3.1 Turning ON the Power	3-2
3.2 Displaying the Self-Test Result	3-4
3.3 Data Displayed on the Screen	3-6
3.4 Presetting	3-9
3.5 Symbols	3-10
3.6 List of Soft Key Menu Functions	3-12
3.7 The Basics of Key Operations	3-14
Section 4 Selecting Measurement Items (Channels Group)	4-1
4.1 Selecting a Measurement Channel (Menu)	4-2
4.2 Active Channel (Active)	4-4
4.3 Selecting an Analysis Port (Meas)	4-4
4.4 Selecting Measurement Items (Format)	4-6

Section 5	Selecting Measurement Parameters (Measurement Group)	5-1
5.1	Setting a Frequency (Frequency, Span)	5-2
5.2	Settings Related to Input/Output (Out/Input)	5-3
5.3	Improving the S/N Ratio and Setting an Delay	
	Aperture (Group Delay Measurement) (Avg)	5-7
5.4	Settings Related to Sweep	5-10
Section 6	Display (Display Group)	6-1
6.1	Active Trace (Active)	6-2
6.2	Setting a Scale (Scale)	6-3
6.3	Setting the Display Screen (Trace)	6-5
6.4	Displaying All Items at the Touch of a Key (Display All)	6-8
6.5	Turning the Backlight ON/OFF (Backlight ON/OFF)	6-9
Section 7	Marker (Marker Group)	7-1
7.1	Setting, Moving, and Displaying Markers (Marker)	7-2
7.2	Useful Marker Functions (Fctn)	7-5
Section 8	Calibration (Calibration Group)	8-1
8.1	Explanation	8-2
8.2	Normalization (X-S)	8-3
8.3	Vector Errors Calibration (Cal)	8-4
8.4	Interpolating Calibration Data	8-9
Section 9	Analysis of Measurement Data (Utility Group)	9-1
9.1	Filter Analysis Function (Filter)	9-2
9.2	Resonator Analysis Function (Resonator)	9-5
9.3	Limit Test (Limit)	9-8

Section 10 Hard Copy and Remote Control (Copy/Memory Group)	10-1
10.1 Outputting a Hard Copy of Screen Data (Copy)	10-2
10.2 Making Settings Related to the Hard Copy and	
Remote Control (Copy Control, Local)	10-2
10.3 Save/Recall	10-6
 Section 11 System	 11-1
11.1 Switching between Marker Setting Modes (Frequency/Point)	11-2
11.2 Selecting an Impedance Measurement Method (Bridge/Transfer Method)	11-2
11.3 Setting the Date and Time	11-3
11.4 Checking Options	11-3
11.5 Setting a Display Color	11-4
11.6 Displaying a Self-test Result	11-4
 Section 12 Measurements	 12-1
12.1 Analyzing a Network	12-2
12.2 Basics of Measurement	12-6
12.3 Measuring Transfer Characteristics	12-7
12.4 Measuring Reflection Characteristics	12-16
12.5 Measuring Transfer and Reflection Characteristics Simultaneously (Option 12)	12-24
12.6 Measuring a Filter	12-27
12.7 Measuring a Resonator	12-29
 Section 13 Performance Tests	 13-1
13.1 Cases where Performance Tests are Required	13-2
13.2 List of Measuring Devices Used for Performance Tests	13-3
13.3 Performance Test	13-4
 Section 14 Maintenance	 14-1
14.1 Cleaning the Cabinet	14-2
14.2 Notes on Storage	14-3
14.3 Repackaging and transporting the System to Return	14-4

Appendixes..... App-1

Appendix A Performance Test Result Form	A-1
Appendix B List of Defaults	B-1
Appendix C List of Controls and Connectors on Front and Rear Panels	C-1
Appendix D List of Error Message	D-1
Appendix E Example of Settings for Video Plotter VP1500 II	E-1

Section 1 Introduction

This section provides a brief overview of the product and explains the manual structure, system configuration, application parts, peripheral devices, and specifications of this system.

1.1	Product Overview	1-2
1.2	Organization of This Manual	1-3
1.3	System Configuration	1-4
1.3.1	Standard configuration	1-4
1.3.2	Options	1-4
1.4	Application Parts and Peripheral Devices	1-5
1.5	Specifications	1-6

Section 1 Introduction

1.1 Product Overview

This system is a network analyzer used to measure transmission and reflection (external reflection bridges are also used) characteristics of electronic parts and circuits over a wide frequency range of 10 Hz to 300 MHz.

This system has a 6.5-inch flat display (640 × 480 dots). This display is a color LCD based on an active matrix drive system.

The display shows a soft key menu, various measurement graphs, and measurement parameters to allow you to specify parameters, make measurements, and output measurement results to the printer and plotter.

This system incorporates measurement ports R, TA, and TB (option), allowing you to measure port-to-port ratios and absolute levels.

This system has a GPIB interface as standard, so you can configure an automatic measurement system easily by connecting a personal computer and other measuring devices. This system also has a PTA (Personal Test Automation) function as standard, so you can use this system as a controller to construct an automatic measurement system without using an external personal computer.

■ Applications

This system can be widely used when developing, adjusting, and inspecting electronic parts and devices in the communications market (for mobile and optical communications, etc.) and the AV market (for high-quality TVs and satellite broadcasting). Especially, the macro analysis function for filters and piezoelectric resonators facilitates and accelerates measurements.

1.2 Organization of This Manual

This manual consists of 14 sections and five appendixes. These sections and appendixes are briefly described below.

Section	Description
Section 1 Introduction	This section provides a brief overview of the product. It also explains the manual structure, system configuration, application parts, and specifications of this system.
Section 2 Preparations before Use	This section explains the safety measures and preparations that must be made before using (turning on) this system.
Section 3 Basic Operations	This section explains basic operations to the operators who use this system for the first time.
Section 4 Selecting Measurement Items	This section explains to select measurement items.
Section 5 Selecting Measurement Parameters	This section explains to set measurement conditions.
Section 6 Displays	This section explains to set the measurement waveforms for easy observation.
Section 7 Markers	This section explains to read the measurement data by the marker and explains other marker functions.
Section 8 Calibrations	This section explains to calibrate the measurement system for eliminating errors.
Section 9 Analysis of measurement data	This section explains the analysis of filter and resonator and the limit test.
Section 10 Hard copy and Remote control	This section explains to output a hard copy of screen data to the printer and save/recall measurement conditions and to set the GPIB remote control etc.
Section 11 System	This section explains the important setting which is not frequently changed of this equipment.
Section 12 Measurements	This section explains the typical measurement.
Section 13 Performance tests	This section explains the measuring devices, setup, and procedures for performance tests.
Section 14 Maintenance	This section explains daily maintenance, long-period storage, repackaging, and transportation.
Appendix A	Performance Test Result Form
Appendix B	List of Defaults
Appendix C	List of Control and Connectors on Front and Rear Panels
Appendix D	Type and Contents of the Error Message
Appendix E	Example of Settings for Video Plotter VP1500 II

Section 1 Introduction

1.3 System Configuration

1.3.1 Standard configuration

The table below shows the components included in the standard configuration.

Item	Type name* ¹ or symbol* ¹	Product name* ¹	Quantity* ¹	Remarks
Main unit	MS4630B	Network analyzer	1	
Accessories		Power cord	1	
	F0013	Fuse	2	Two 5 A fuses, for AC line T5 A250V
	W1534AE	Operation	1 set	Panel Operation
W1535AE	Manuals	Remote Operation		

NOTE:

*1 When you order a system component, let us know its type name (or symbol), product name, and quantity.

1.3.2 Options

Options for this system are as follows:

Option No.	Product name	Quantity	Remarks
01	PMC interface	1	FUJISOKU memory card interface
02	RS-232C, Centronics interface	1	
10	Output attenuator	1	0 to 70 dB, Variable in steps of 10 dB
12	3-ch receiver	1	
13	High stability reference oscillator	1	
14	3-branch output	1	

1.4 Application Parts and Peripheral Devices

The table below lists the application parts and peripheral devices for the MS4630B. All are optionally available.

Application Parts and Peripheral Devices

Type name* ¹ or symbol* ¹	Product name* ¹	Remarks
J0007	GPIB connection cable, 1 m	408JE-101
J0008	GPIB connection cable, 2 m	408JE-102
P0005	Memory card (32K bytes)	BS32F1-C-172, Battery life: About 5 years
P0006	Memory card (64K bytes)	BS64F1-C-173, Battery life: About 5 years
P0007	Memory card (128K bytes)	BS128F1-C-174, Battery life: About 4.3 years
P0008	Memory card (256K bytes)	BS256F1-C-175, Battery life: About 2.2 years
P0009	Memory card (512K bytes)	BS512F1-C-176, Battery life: About 1.1 years
J0079	Fixed attenuator for high power	DC to 8 GHz, 30 dB, 25 W
J0395	Fixed attenuator for high power	DC to 9 GHz, 30 dB, 30 W
B0334C	Carrying case	With protection cover and casters
B0329C	Protection cover	
B0331C	Front handles	A set of two handles
B0333C	Rack mount kit	
MC3305A	PTA keyboard	JIS type
MC3306A	PTA keyboard	ASCII type
VP-1500II	Video plotter	
Z0047	Paper for UA-455A	A set of 5 rolls
62BF50	Reflection bridge	10 to 1000 MHz, BNC-P, 50 Ω , unbalance
62B50	Reflection bridge	10 to 1000 MHz, BNC-J, 50 Ω , unbalance
62BF75	Reflection bridge	10 to 1000 MHz, BNC-J, 75 Ω , unbalance
62B75	Reflection bridge	10 to 1000 MHz, BNC-P, 75 Ω , unbalance
MA2201A	Reflection bridge	10 Hz to 250 kHz, 600 Ω , balance, MA214 terminal
MA2202A	Reflection bridge	10 Hz to 250 kHz, 600 Ω , balance, MA214 terminal
MA2203A	Reflection bridge	10 Hz to 250 kHz, 900 Ω , balance, MA214 terminal
MA2301A	Reflection bridge	2 kHz to 2 MHz, 75 Ω , balance, MA214 terminal
MA2302A	Reflection bridge	2 kHz to 2 MHz, 135 Ω , balance, MA214 terminal
MA2303A	Reflection bridge	2 kHz to 2 MHz, 150 Ω , balance, MA214 terminal
MA2204A	Impedance probe	30 Hz to 300 kHz, 2 Ω to 1 M Ω
MA2403A	Impedance probe	30 kHz to 30 MHz, 2 Ω to 1 M Ω
MA414A	Impedance measuring kit	for MA2403A
MA1506A	π -circuit fixture	DC to 125 MHz, for resonator measurement
MA4605A	Impedance conversion adapter	DC to 300 MHz, 50 Ω : 75 Ω unbalance
ME010 Serie	test fixture	PIN, AMD, chip inductor, etc.

NOTE:

*1 When you order a product, let us know its type name (or symbol), product name, and quantity.

Section 1 Introduction

1.5 Specifications

Measurement item	Transmission characteristic (measurement of ratios): Magnitude, phase, and group delay Reflection/impedance characteristics: Magnitude and phase (An external transducer is also used.) Level characteristic: Absolute magnitude
Frequency	Range: 10 Hz to 300 MHz Resolution: 0.01 Hz Accuracy (standard) Aging rate: $\leq \pm 10^{-6}$ /day (15 min. after power-on) Temperature characteristic: $\leq \pm 5 \times 10^{-6}$ (0 to 50°C) Accuracy (Option 13: High-stability reference resonator) Aging rate: $\leq \pm 2 \times 10^{-8}$ /day (24 hours after power-on) Temperature characteristic: $\leq \pm 5 \times 10^{-8}$ /day (0 to 50°C)
Input	Number of channels Standard: 2 (R, TA), Option 12: 3 (R, TA, TB) Impedance: Switchable between 50 Ω and 1MΩ (between 75 Ω and 1 MΩ when the MA4605A is used) Input range (IRG): 0/+20 dBm Maximum input power AC: +20 dBm DC: ± 2.2 V (50 Ω) AC: 0 dBm DC: ± 20 V (1 M Ω) Connector: BNC-J Probe source: +12 \pm 1 V, 100 mA (with a circuit for protection against shorts)
Average noise level	≤ -120 dBm (RBW : 1 kHz, 1 to 300 MHz), ≤ -110 dBm (RBW : 1 kHz, 80 kHz to 1 MHz)
Cross talk	Between channels: ≥ 120 dB (80 kHz to 300 MHz), ≥ 110 dB (to 80 kHz) Between transmitter and receiver circuits: ≥ 125 dB
Resolution bandwidths	3, 10, 30, 100, 300, and 500 Hz, 1, 2, 3, 4, 5, 10, and 20 kHz, and automatically set bandwidth
Output	Output level range Output A: 0 to +21 dBm, Option 10: -70 to +21 dBm Output B (standard): -6 to +15 dBm , Option 10: -76 to +15 dBm Output B (Option 14): -9.5 to +11.5 dBm, Option 10: -79.5 to +11.5 dBm (take 6 dB from above value, when uses with MA4605A 75 ohm adapter) Output resolution: 0.01 dB Output level accuracy: $\leq \pm 1.0$ dB (Frequency: 100 MHz, A output: +10 dBm) Output level linearity: ≤ 0.5 dB (at 0 dBm, Frequency: 100 MHz, A output: 0 to +21 dBm) Output level deviation: ≤ 1.5 dB (A output: +10 dBm at 100 MHz) Step error: ± 0.5 dB (option 10) Output impedance: 50 Ω (75 Ω when the MA4605A is used) Connector: BNC-J

1.5 Specifications

Magnitude measurement	Measurement range:	≥120 dB																					
	Measurement resolution:	0.001 dB																					
	Display scale:	0.01 dB/div to 50 dB/div (1-2-5 sequence)																					
	Dynamic accuracy																						
		<table border="1"> <thead> <tr> <th>Level relative to IRG</th> <th>80 kHz to 100 MHz</th> <th>10 kHz to 300 MHz</th> </tr> </thead> <tbody> <tr> <td>0 to -10 dB</td> <td>±0.2 dB</td> <td>±0.2 dB</td> </tr> <tr> <td>-10 to -60 dB</td> <td>±0.05 dB</td> <td>±0.05 dB</td> </tr> <tr> <td>-60 to -70 dB</td> <td>±0.10 dB</td> <td>±0.30 dB</td> </tr> <tr> <td>-70 to -80 dB</td> <td>±0.30 dB</td> <td>±1.00 dB</td> </tr> <tr> <td>-80 to -90 dB</td> <td>±1.20 dB</td> <td>±4.00 dB</td> </tr> <tr> <td>-90 to -100 dB</td> <td>±4.00 dB</td> <td>–</td> </tr> </tbody> </table>	Level relative to IRG	80 kHz to 100 MHz	10 kHz to 300 MHz	0 to -10 dB	±0.2 dB	±0.2 dB	-10 to -60 dB	±0.05 dB	±0.05 dB	-60 to -70 dB	±0.10 dB	±0.30 dB	-70 to -80 dB	±0.30 dB	±1.00 dB	-80 to -90 dB	±1.20 dB	±4.00 dB	-90 to -100 dB	±4.00 dB	–
Level relative to IRG	80 kHz to 100 MHz	10 kHz to 300 MHz																					
0 to -10 dB	±0.2 dB	±0.2 dB																					
-10 to -60 dB	±0.05 dB	±0.05 dB																					
-60 to -70 dB	±0.10 dB	±0.30 dB																					
-70 to -80 dB	±0.30 dB	±1.00 dB																					
-80 to -90 dB	±1.20 dB	±4.00 dB																					
-90 to -100 dB	±4.00 dB	–																					
Phase measurement	Measurement range:	±180°																					
	Measurement resolution:	0.001°																					
	Display scale:	0.01 to 50°/div (1-2-5 sequence)																					
	Dynamic accuracy																						
		<table border="1"> <thead> <tr> <th>Level relative to IRG</th> <th>80 kHz to 100 MHz</th> <th>10 kHz to 300 MHz</th> </tr> </thead> <tbody> <tr> <td>0 to -10 dB</td> <td>±1.5°</td> <td>±1.5°</td> </tr> <tr> <td>-10 to -60 dB</td> <td>±0.3°</td> <td>±0.3°</td> </tr> <tr> <td>-60 to -70 dB</td> <td>±0.8°</td> <td>±2.0°</td> </tr> <tr> <td>-70 to -80 dB</td> <td>±2.0°</td> <td>±6.0°</td> </tr> <tr> <td>-80 to -90 dB</td> <td>±6.0°</td> <td>±20.0°</td> </tr> <tr> <td>-90 to -100 dB</td> <td>±20.0°</td> <td>–</td> </tr> </tbody> </table>	Level relative to IRG	80 kHz to 100 MHz	10 kHz to 300 MHz	0 to -10 dB	±1.5°	±1.5°	-10 to -60 dB	±0.3°	±0.3°	-60 to -70 dB	±0.8°	±2.0°	-70 to -80 dB	±2.0°	±6.0°	-80 to -90 dB	±6.0°	±20.0°	-90 to -100 dB	±20.0°	–
Level relative to IRG	80 kHz to 100 MHz	10 kHz to 300 MHz																					
0 to -10 dB	±1.5°	±1.5°																					
-10 to -60 dB	±0.3°	±0.3°																					
-60 to -70 dB	±0.8°	±2.0°																					
-70 to -80 dB	±2.0°	±6.0°																					
-80 to -90 dB	±6.0°	±20.0°																					
-90 to -100 dB	±20.0°	–																					
Group delay measurement	Measurement range:	1 ps to 400 ms																					
	DRG:	$\Delta\theta/(360 \times \Delta F)$																					
	$\Delta\theta$:	Phase measurement range																					
	ΔF :	Frequency span \times Smoothing aperture (%)																					
	Smoothing aperture:	20 to $\frac{2}{\text{number of measurement points}} \times 100$ (%)																					
	Measurement resolution:	$2.78 \times 10^{-5}/\Delta F$																					
	Display scale:	1 ps/div to 50 ms/div																					
	Dynamic accuracy:	Phase measurement accuracy/(360 \times Aperture frequency)																					
Calibration	Calibration type:	RESPONSE, 1PORT, 1PATH 2PORT, RESPONSE/ISOLATION, π -NET																					
	Calibration data interpolation:	When the measurement frequency or number of measurement points is changed, new calibration data can be obtained by interpolation according to the old data (except when a log frequency is set or the number of measurement points is 1001).																					
	Normalization:	X-S																					
	Electric length correction range:	0 to ±999999.999999 m, Resolution: 100 nm																					
	Phase offset range:	±180°																					

Section 1 Introduction

<p>Sweep</p>	<p>Frequency sweep: LIN (CENTER/SPAN, START/STOP), LOG (START/STOP)</p> <p>Level sweep: LIN (START/STOP/STEP)</p> <p>Number of measured points: 11, 21, 51, 101, 251, 501, 1001</p> <p>Number of breakpoints: Any number between 1 and 1001</p> <p>Sweep time: 150 us/point, 38 ms/250 points, all sweep (RBW: 20 kHz, normalization, 1 trace)</p> <p>Setting range: 1 ms to 27.5 h</p> <p>Sweep function</p> <p>Sweep range: All sweep or partial sweep (between markers), List sweep</p> <p>Sweep control: REPEAT/SINGLE, STOP/CONT</p> <p>Sweep trigger: INT/EXT (RISE, FALL, LEVEL)</p>
<p>Display</p>	<p>Maximum number of screens displayed: 2 channels, 4 traces</p> <p>Analysis formats: LOG MAG (M), PHASE (P), DELAY (D), M/P, M/D, LIN MAG (LIN), LIN/P, LIN/D, REAL(R), IMAG (I), R/I, Z, Z/θ, Q, Z/Q, POLAR, VSWR, IMPD (Z∠θ, Rs/Ls, Q/D, R+jx), ADMT (Y∠θ, Rp/Lp, Cp, Q/D, G+jB)</p> <p>Display unit: 640 × 480 dots, 6.5-inch, color LCD</p>
<p>Marker</p>	<p>Marker function: NORMAL MKR, ΔMKR, 0MKR, MKR→MAX, MKR→MIN, MKR→CF, Δ→SPAN, MKR→+PEAK, MKR→-PEAK, MKR TRACK+PEAK, MKR TRACK-PEAK, MKR CHANGE, MKR→OFFSET</p> <p>Setting: Set each marker position with a frequency or point.</p> <p>Multi-marker: A maximum of ten markers can be set for each trace.</p> <p>Filter functions: F0, IL, pass band (L, R), attenuation band (L, R), Ripple, Q, SF</p> <p>Resonator functions</p> <p>RESON1: Fr, Fa, Zr, Za (0 PHASE) and Fm, Fn, Fm, Fn (MAX/MIN)</p> <p>RESON2: Fs, Fr, Fa, Zr, Za, Q, equivalent constants (R1, L1, C1, CO)</p>
<p>Trace data computation</p>	<p>Averaging function</p> <p>System: SUM, MAX, MIN</p> <p>Number of times: 1 to 1000</p> <p>Measurement data memory (Each memory has up to 1001 points and has the same data format as the analysis format.)</p> <p>Main trace (MT) memory: Two for channel 1 and two for channel 2 (XMEM)</p> <p>Calibration S memory: Two for channel 1 and two for channel 2 (SMEM)</p> <p>Image memory: Two for channel 1 and two for channel 2 (IMEM)</p> <p>Subtrace (ST): The following computations can be performed between MT and ST. (Computations are performed on the data which is the same as the display data.)</p> <p>MT→ST, MT = MT-ST, MT = ST</p> <p>Limit line: A single limit line or a segment (10) can be set. Judgement can be passed according to the limit line.</p>

1.5 Specifications

Measurement parameter automatic setting	Resolution bandwidth and sweep time: The resolution bandwidth is automatically set for the set sweep time. The minimum sweep time is automatically set for the set receive bandwidth.
Auxiliary storage device	Data storage and fetching: Able to store the measuring conditions, measurement data, calibration data and PTA application program in the internal memory, FD and PMC and fetch them. Function memory Up to 100 functions (however, the maximum number of functions depends on the storage capacity) Storage device and capacity Internal memory: 1 Capacity: 512 KB (Non-volatile) 3.5-inch FDD: 1 unit Capacity: 720 KB (2 DD), 1.44 MB (2 HD), MS-DOS format PMC (Option 01): 1 slot Capacity: 32 to 512 KB
Hard copy	Hard copy output to video plotte, printer and FD
Input/output connectors on rear panel	Reference resonator input Frequency: 5/10 MHz –10 ppm Level: ≥ 0.7 Vp-p (AC connection) Input impedance: 50 Ω (BNC-J connector) Reference resonator output Frequency: 10 MHz Level: TTL (DC connection, BNC-J connector) External trigger input: TTL level (BNC-J connector) GPIB: Conforms to IEEE488.2 (24-pin Amphenol connector) I/O port: Parallel interface for PTA (36-pin Amphenol connector) RGB output: For external monitor (15-pin D-sub connector) Video output: Separate (round DIN 8-pin) Centronics (option 02): Parallel interface for printer (25-pin D-sub connector) RS-232C (option 02): Serial interface (9-pin D-sub connector)
External control	Standard: GPIB and PTA, Option 02: RS-232C
Power supply	100 to 110/200 to 240 VAC (—15/10%, max. 250 V, auto switching between 100 V and 200V), 47.5 to 63 Hz, ≤ 180 VA (max.)
Dimensions and weight	426 (W) \times 177 (H) \times 451 (D) mm, ≤ 15 kg
Operating temperature	0 to +50°C (+4 to 50°C during FDD operation)
EMC	Conducted disturbance: EN 61326-1: 2006 (Class A)
	Radiation disturbanc: EN 61326-1: 2006 (Class A)
	Harmonic Current Emission: EN 61000-3-2: 2006 (Class A)
	Electrostatic Discharge: EN 61326-1: 2006 (Table 2)
	Electromagnetic Field Immunity: EN 61326-1: 2006 (Table 2)
	Fast Transient / Burst: EN 61326-1: 2006 (Table 2)
	Surge: EN 61326-1: 2006 (Table 2)
	Conducted RF: EN 61326-1: 2006 (Table 2)
Voltage Dips / Short Interruptions: EN 61326-1: 2006 (Table 2)	

Section 1 Introduction

Section 2 Preparations before Use

This section explains the safety measures that must be taken before using the system and the preparations that must also be made before using the system. These safety measures must be taken to protect the human body and equipment. The preparations that must be made before use include installation of this system in a rack, piling up this system along with other units, protective grounding, fuse replacement, and storage medium handling. For how to connect the GPIB cable and set addresses, see the Operation Manual (GPIB Remote Control).

2.1	Environmental Conditions of Installation Site	2-2
2.1.1	Places to avoid	2-2
2.1.2	Distance from fan	2-2
2.2	Safety Measures	2-3
2.2.1	General safety measures related to power supply	2-3
2.2.2	Maximum operation level of input terminals	2-4
2.2.3	When the fan stops	2-5
2.3	Mounting on a Rack and Stacking with Other Units	2-6
2.3.1	Mounting on a rack	2-6
2.3.2	Stacking with other units	2-6
2.4	Preparations to Make before Turning ON the Power	2-7
2.4.1	Connecting the Power Cord	2-8
2.4.2	Replacing fuses	2-9
2.5	Notes on Handling Storage Medium	2-10
2.5.1	Floppy disk (FD)	2-11
2.5.2	Plug-in memory card (PMC)	2-13

Section 2 Preparations before Use

2.1 Environmental Conditions of Installation Site

2.1.1 Places to avoid

This system operates normally within the ambient temperature range of 0 to 50 °C(4 to 50 °C ,when Floppy disc drive is operating). To get the most from this system, avoid using it in the following places:

- Place exposed to strong vibrations
- Humid or dusty place
- Place exposed to direct sunlight
- Place exposed to active gases

To assure stable operation for an extended period, it is recommended that the system be used in a place where the supply voltage fluctuates little.

CAUTION

Using this unit at room temperatures after using or leaving it at low temperatures for a long period could cause the internal circuits to short because of condensation.

To prevent this, be sure to turn ON the POWER switch after the system has been allowed to dry fully.

2.1.2 Distance from fan

This system has a fan on the back panel to prevent the internal temperature from rising excessively. Ensure that the system is installed with a minimum clearance of 10 cm from the rear vent to the wall, another unit, and so forth.

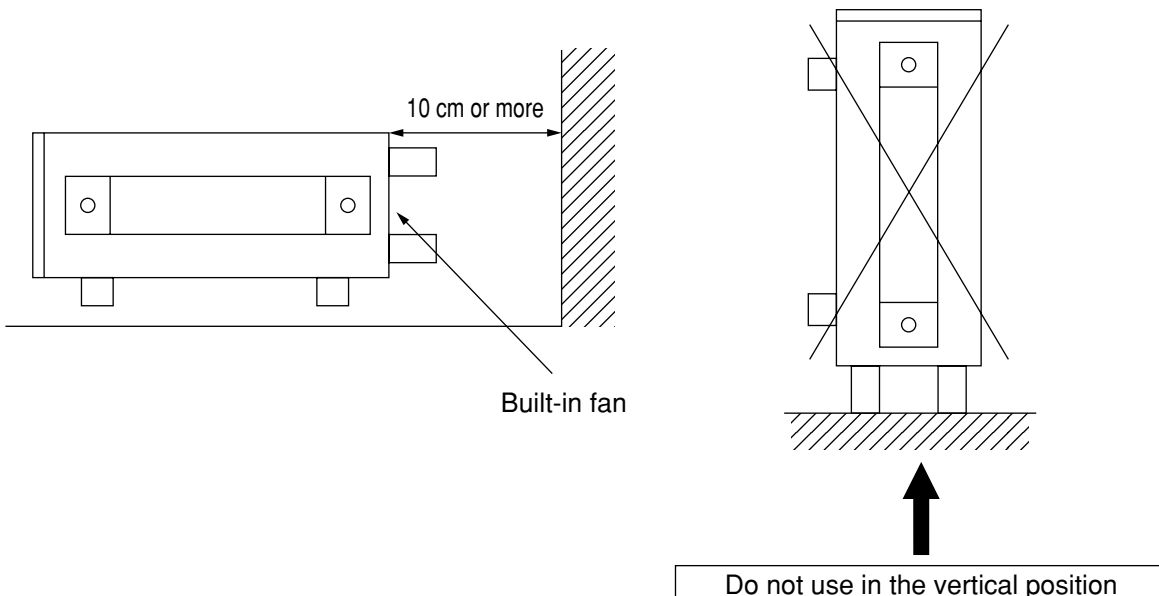

2.2 Safety Measures

This section explains the safety measures that must be taken to prevent personal and system damage and interruption of system operation.

2.2.1 General safety measures related to power supply

WARNING

- **Before turning ON the power:**

Always establish a protective ground. Turning ON the power without establishing a protective ground could cause electric shock which might result in severe injury or loss of life. Also check the supply voltage. If a high voltage exceeding the specified value is applied, system damage or a fire could result.

- **While turning ON the power:**

During maintenance, it is sometimes necessary to check or adjust the inside of the system with the upper, lower, or side cover open. Touching a high voltage circuit inside the system carelessly could cause electric shock which might result in severe injury or loss of life. Ask qualified service personnel to perform maintenance.

Section 2 Preparations before Use

2.2.2 Maximum operation level of input terminals

The maximum operation level of the input terminals of this system is +20 dBm. Do not exceed this level. The maximum output level of the output terminals is 21 dBm (A output).

CAUTION

The maximum operation level of the input terminals of this system is +20 dBm. Supplying a signal exceeding this level could burn the input ATT and input mixer.

 is a symbol used to alert operators to a specific operating procedure that, if not followed, may result in severe damage to the operators and system. If supplying a signal including direct current component could burn the internal circuit.

These signal could not be measured. Take out direct current component of the signal before measure it.

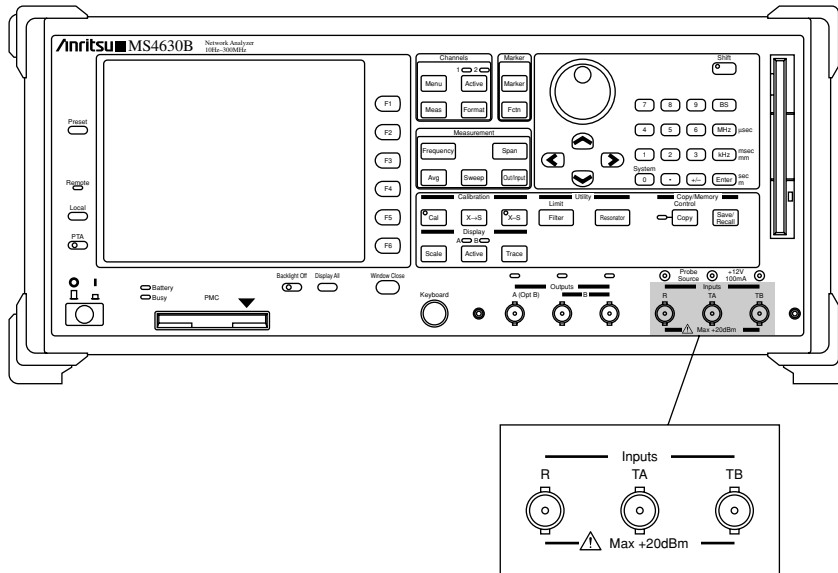

2.2.3 When the fan stops

WARNING

The device has a fan installed at the rear panel to prevent the interior temperature from rising excessively. When the fan stops for some reasons, the temperature within the unit frame rise to such an extent that it may cause a fire. For this reason, the device displays a message on the screen warning against the stoppage of the fan at the rear panel (See (3) message concerning the device abnormality of Appendix D Error Message). When this message is displayed, immediately turn off the power of the device and take out the power cord from the power outlet. As the unit frame is considered to have reached a high temperature in this instance, take due precautions when handling it.

Section 2 Preparations before Use

2.3 Mounting on a Rack and Stacking with Other Units

2.3.1 Mounting on a rack

To mount this system in a rack, a rack mount kit B0333C (option) is required. Mount the system according to the illustration included in the rack mount kit.

2.3.2 Stacking with other units

To pile up this system and other units with the same width and depth, use linkage plates B0332 (option) for secure linkage.

As these linkage plates are provided with an auto lock mechanism, the upper and lower units are locked automatically.

2.4 Preparations to Make before Turning ON the Power

This system operates normally from a 100 Vac +10/-15 % power source. AC power must be supplied after taking measures to prevent the following:

- Injury and loss of life resulting from electric shock
- Damage to internal circuits which results from abnormal voltage
- Troubles resulting from ground current

The WARNING and CAUTION on the rear panel are used for safety related information to prevent the risk of the operator's injury.

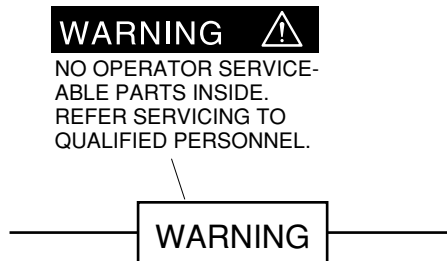

Users should not repair the system. Never open covers and disassemble internal parts. To perform maintenance, call Anritsu service personnel, who have undergone specific training and are thoroughly acquainted with fire and electric shocks. Touching a high voltage circuit inside the system carelessly could cause electric shock which might result in severe injury or loss of life, or it could damage precision parts.

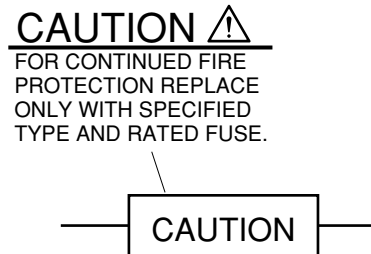

Be sure to replace fuses with ones of the specified type and rating. Using fuses of a different type or rating could cause a fire.

Observe the precautions given on the following pages.

Section 2 Preparations before Use

2.4.1 Connecting the Power Cord

Check that the POWER switch on the front panel is turned off (switched to the (O) side).

Insert the power plug into an outlet, and connect the other end to the power inlet on the rear panel. To ensure that the instrument is grounded, always use the supplied 3-pin power cord, and insert the plug into an outlet with a ground terminal. (2) Grounding using a conversion adapter

WARNING

If the power cord is connected without the instrument grounded, there is a risk of receiving a fatal electric shock. In addition, the peripheral devices connected to the instrument may be damaged.

When connecting to the power supply, DO NOT connect to an outlet without a ground terminal. Also, avoid using electrical equipment such as an extension cord or a transformer.

CAUTION

If an emergency arises causing the instrument to fail or malfunction, disconnect the instrument from the power supply by either turning off the POWER switch on the front panel (switch to the (O) side), or by pulling out the power cord or the power inlet.

When installing the instrument, place the instrument so that an operator may easily operate the POWER switch.

If the instrument is mounted in a rack, a power switch for the rack or a circuit breaker may be used for power disconnection.

2.4.2 Replacing fuses

WARNING

-
- Replacing a fuse with the power on could cause electric shock. Before replacing a fuse, turn OFF the POWER switch and unplug the power cord from the wall outlet.
 - Turning ON the power without establishing a protective ground could cause electric shock.
An abnormal AC supply voltage could damage the internal circuits. After replacing a fuse, establish the protective ground by one of the methods explained before, make sure the AC supply voltage is normal, then turn ON the POWER switch.
-

CAUTION

If you do not have a spare fuse, use a fuse of the same type and voltage and current ratings as those of the blown fuse.

- A fuse of a different type or rating could make it difficult to remove or attach, cause poor contact or delayed blowing.
 - A fuse with too high a voltage or current rating may not blow and thus cause a fire upon reoccurrence of a fault.
-

Two 5 A fuses come standard with the system as shown in Section 1.3.1.

Set these fuses in the fuse holders.

If a fuse is blown due to any problem, determine and remedy the cause before replacing the fuse.

Then, replace the fuse following the procedure below.

Step	Operation
1	Set the POWER switch on the front panel to the ○ (OFF) position, then unplug the power cord from the wall outlet.
2	Turning the fuse holder cap counterclockwise with a standard screwdriver allows you to remove it along with the fuse.
3	Remove the fuse from the fuse cap and insert a spare fuse into it (any end first).
4	Replace the fuse cap in the fuse holder and tighten it by turning it clockwise with a standard screwdriver.

2.5 Notes on Handling Storage Medium

CAUTION

Do not remove a storage medium, such as a plug-in memory card or floppy disk, while it is being accessed. While a storage medium is being accessed, the BUSY lamp is lit. If a storage medium is removed while it is being accessed, the data recorded on it could be destroyed.

This system uses a floppy disk (or an optional plug-in memory card) to store setting data and programs.

Abusing a storage medium could erase the data on it. It is recommended that backup copies of important data be created.

We assume no responsibility for loss of the data stored on storage media.

Notes on handling floppy disks and the plug-in memory card are provided in the following section.

2.5.1 Floppy disk (FD)

This section explains how to handle 3.5-inch floppy disks, a storage medium used in this system.

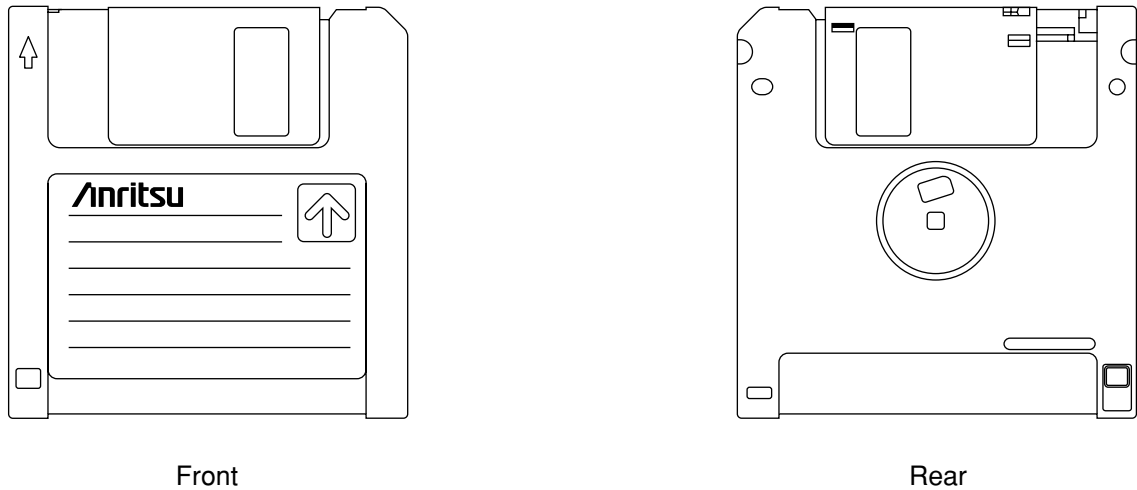

Fig. 2-1 3.5-inch floppy disk

(1) Handling notes

The plastic case of a 3.5-inch floppy disk has a shutter, which protects the surface of the internal disk. When the floppy disk is set in the floppy disk drive, the shutter opens automatically, exposing part of the internal disk. Do not touch (slide) the shutter.

Observe the following precautions:

- (a) When the LED on the floppy disk drive is lit, never remove the floppy disk. If removed, the data on it could be destroyed or the floppy disk drive could break.
- (b) Do not touch the magnetic disk surface with a finger or any object.
- (c) Do not leave floppy disks in a dusty or humid place.
- (d) Do not place floppy disks near a magnetic object.
- (e) Do not leave floppy disks in a place exposed to direct sunlight or near a heater.
- (f) Store floppy disks in a place where the temperature is 4 to 53 °C and the humidity is 8 to 90 % (take measures against condensation, as necessary).

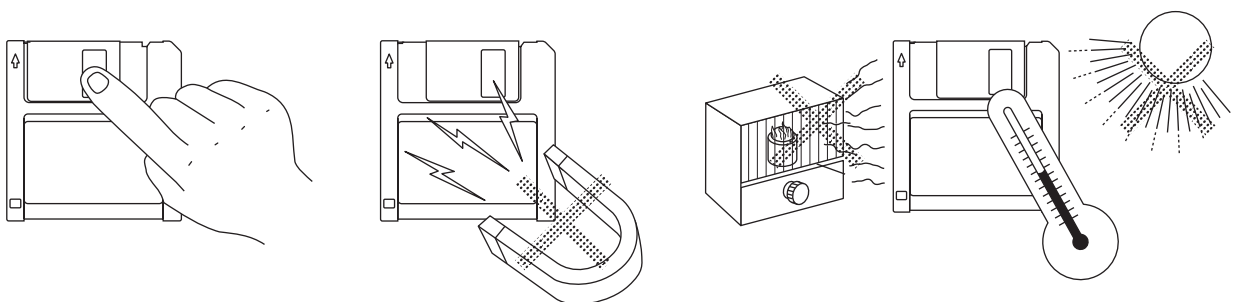

Section 2 Preparations before Use

(2) Write protect switch

A 3.5-inch floppy disk has a write protect tab so that its contents are not modified or deleted by mistake. To turn ON write-protection, slide the write protect tab in the direction of the arrow as shown below. (If an attempt is made to write data with write-protection on, an error will result.)

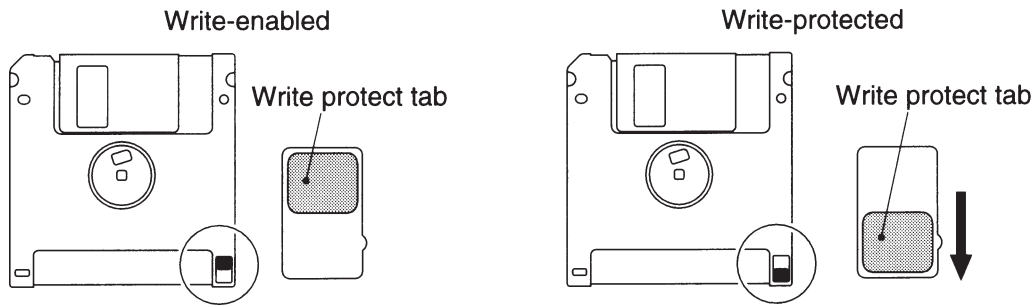

Fig. 2-2 Write protect switch of 3.5-inch floppy disk

(3) Setting and removing a 3.5-inch floppy disk

To set a floppy disk in the floppy disk drive, insert it in the direction of the arrow with the top surface left until it clicks.

To remove a floppy disk from the floppy disk drive, press the EJECT button. Make sure the LED is OFF before removing the floppy disk.

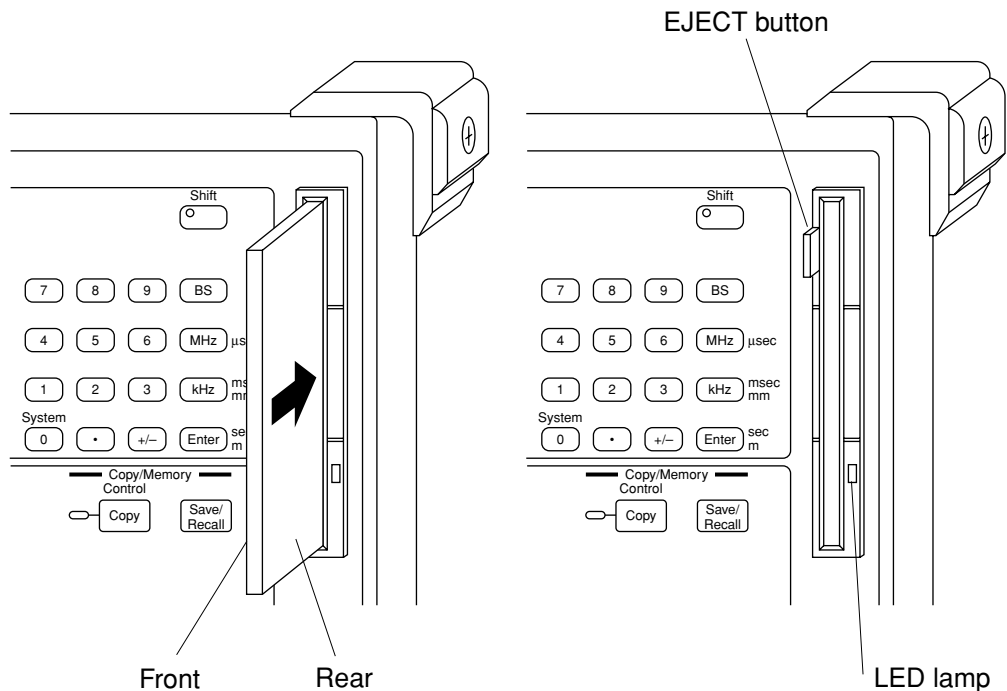

Fig. 2-3 Setting and removing a 3.5-inch floppy disk

2.5.2 Plug-in memory card (PMC)

This section explains the following points about the plug-in memory card. (hereafter called the PMC)

- Inserting in the slot in the main unit
- Handling notes
- Handling the cap
- Loading and replacing a battery
- Using the write protect switch

(1) Inserting the PCM into the slot in the main unit

CAUTION

Inserting the PCM by force could damage the electrodes. Insert it properly as shown below.

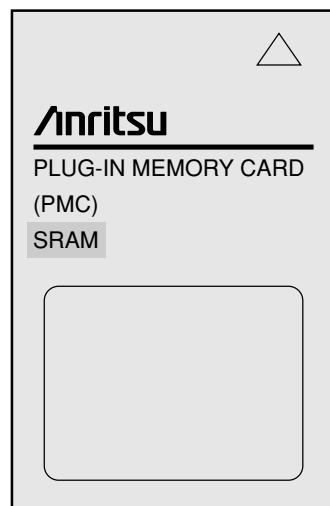
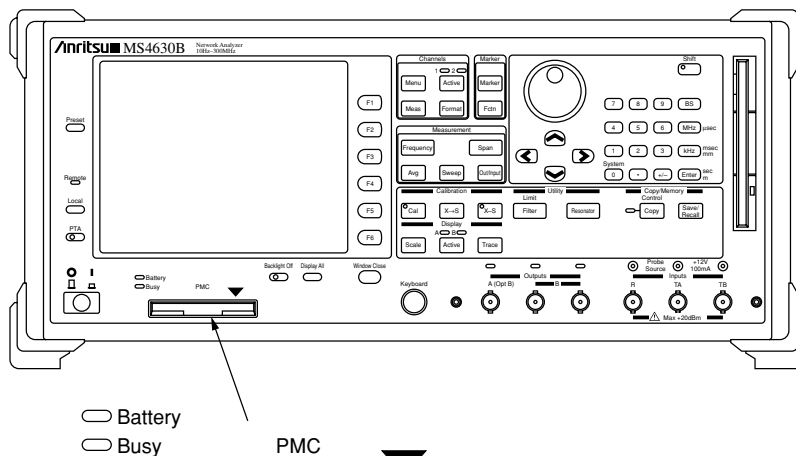

- 1) Hold the PMC with the surface marked with a green triangle up.
- 2) Holding the PMC horizontally, align the triangle printed on the PMC with the triangle printed on the front panel of the main unit.
- 3) Slowly insert the PMC straight into the slot until it stops.

Note:
Inserting the PCM by force could damage the connector.

Insert the PMC into the slot in the main unit properly as mentioned above.

Section 2 Preparations before Use

(2) Notes on handling the PMC

- (a) Do not subject the PMC to strong shock by dropping or bending it.
- (b) Do not expose it to water.
- (c) Do not expose it to high temperature, high humidity, or direct sunlight.
- (d) Do not insert tweezers or the like into the PMC connector.
- (e) Protect the PMC connector from dust.
- (f) Do not insert any unspecified PMC into the PMC slot.
- (g) 128-KB, 256-KB, and 512-KB plug-in memory cards are shipped with a battery that is not loaded. Load it before use.
- (h) Lives of batteries at room temperatures are listed below. When the battery has been used up, the data stored in the PMC disappears. Replace the battery before it is used up. On the back of the PMC a “Battery replacement schedule” section is provided. Immediately after loading a new battery, enter the scheduled battery replacement date in this section according to the table below.

PMC形名	Memory capacity	Battery life	Battery
BS32F1-C-172	32 KB	About 5 years	BR2325
BS64F1-C-173	64 KB	About 5 years	
BS128F1-C-174	128 KB	About 4.3 years	
BS256F1-C-1175	256 KB	About 2.2 years	
BS512F1-C-1176	512 KB	About 1.1 years	

Immediately after loading a new battery, enter the scheduled battery replacement date in this section.

CAUTION

- 電池寿命 (32K/バイト):約5年 (常温)
Battery life:About 5 years
(at room temperature)
- 機器電源をONにして、プラグイン状態で電池を交換してください。
Battery replacement must be done by inserting the card into the instrument while the power is on.
- 電池はBR2325を使用してください。
Use only BR2325 battery.
- 強いショックを与えたり、折り曲げないこと。
Do not drop or bend.
- 高温高湿・直射日光にさらさないこと。
Do not expose to extreme temperature or wetness.

次回電池交換予定日
Battery replacement Schedule
Date : _____

ANRITSU CORP. MADE IN JAPAN

When the red “Battery” lamp lights up, this indicates that the battery voltage is too low. Replace the battery as soon as possible.

2.5 Notes on Handling Storage Medium

(3) Handling the cap

The cap prevents the PMC from being inserted upside down or right side left. Usually, use the PMC with the cap attached. However, remove the cap in the following cases:

- When the shape of the PMC insertion slot in the main unit is as shown below:

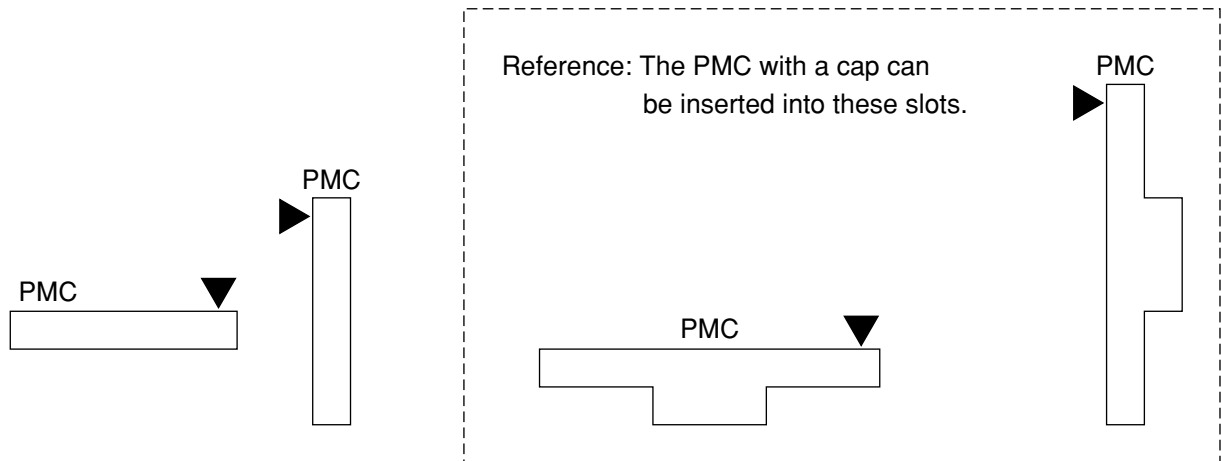

- The cap must be removed when replacing the battery.

[Removing the cap]

The cap can be removed easily with its back ("CAUTION" is printed) up.

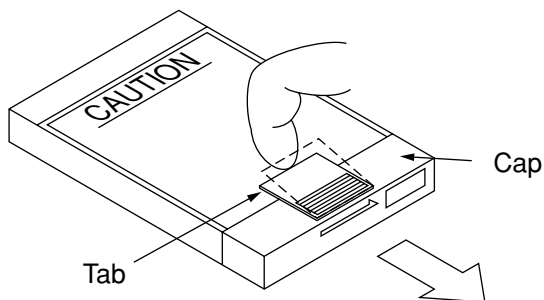

While raising the Cap slightly (up to the position indicated by the dotted line), slide it in the direction of the arrow.

Section 2 Preparations before Use

(4) Loading and replacing a battery

■ Loading a battery initially (SRAM only)

Do not forget to load the enclosed lithium battery before using the PMC. When loading the battery, place the PMC with its back (“CAUTION” is printed) up.

- 1) Remove the cap from the PMC.
- 2) Unlock the battery holder and draw out the battery holder.
- 3) Put the battery in the battery holder with the + mark up.
- 4) Insert the battery holder into the slot in the PMC, lock it, then attach the cap.

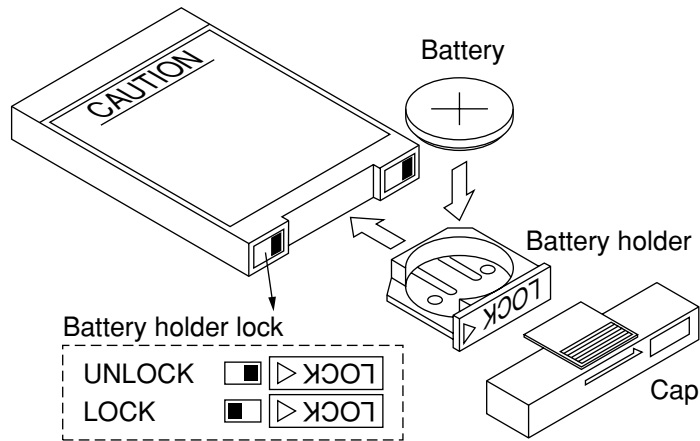

■ Replacing the battery (SRAM only)

Replace the battery while the system is powered on and with the PMC set in the system.

If a battery is replaced while the system power is OFF or the PMC is removed from the system, the data stored in the PMC could disappear.

Step	Operation
1	Have a lithium battery ready.
2	Turn ON the system.
3	Remove the cap from the PMC and insert the PMC into the PMC slot (align the green triangle with the triangle on the front panel of the main unit).
4	Unlock the battery holder.
5	Draw out the battery holder and replace the battery with a new one.
6	Insert the battery holder into the PMC and lock the battery holder.
7	Remove the PMC from the slot and attach the cap.

2.5 Notes on Handling Storage Medium

- 1) Turn ON the POWER switch.
- 2) Insert the PMC as mentioned on page 2-13.
- 3) Place your finger nail in the groove in the battery holder and draw out the battery holder.
- 4) Put a new battery (BR2325) in the battery holder and insert the battery holder into the PMC.

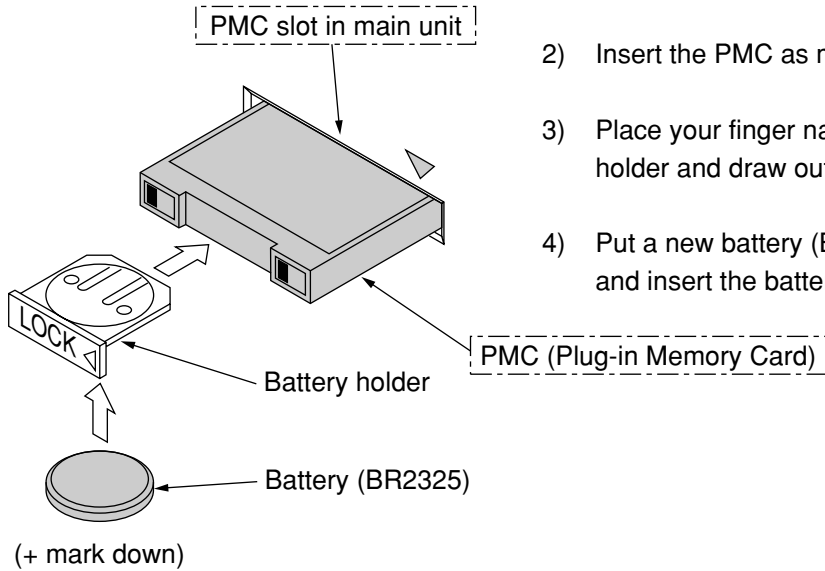

■ Locking the battery holder

To lock the battery holder, slide the LOCK switch to the left using a ballpoint pen or the like.

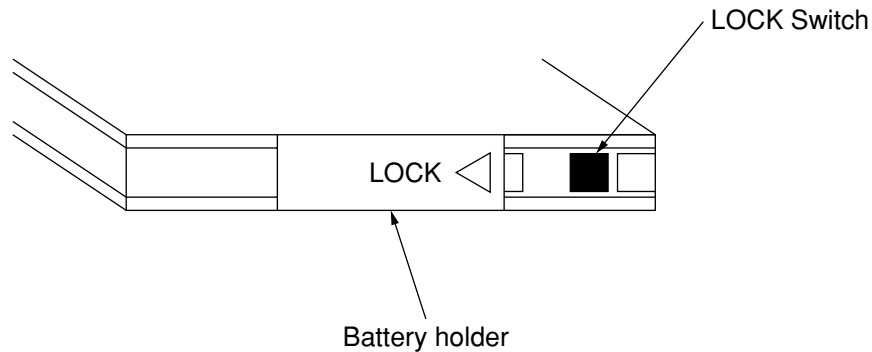

(5) Using the write protect switch (SRAM only)

The write protect switch is factory-set at the OFF position. To turn ON write-protection, slide the write protect switch to the ON position using a ballpoint pen or the like.

If write-protection can be turned ON by software, keep the write protect switch set at the OFF position.

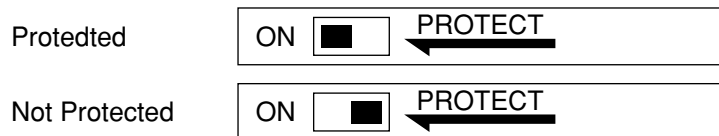

Section 2 Preparations before Use

Section 3 Basic Operations

This section explains the basic operations of this network analyzer for operators who use it for the first time.

Note that this section covers only the basic operations which are necessary to quickly and easily check the status of the basic operations and performance of this system.

For advanced operations, see Sections 4 and later.

3.1	Turning ON the Power	3-2
3.2	Displaying the Self-Test Result	3-4
3.3	Data Displayed on the Screen	3-6
3.4	Presetting	3-9
3.5	Symbols	3-10
3.6	List of Soft Key Menu Functions	3-12
3.7	The Basics of Key Operations	3-14
3.7.1	Hard keys (master keys)	3-14
3.7.2	Soft keys	3-14
3.7.3	Operation windows	3-14
3.7.4	Operations to Perform in Windows	3-15
3.7.5	Channels and Traces	3-16

Section 3 Basic Operations

3.1 Turning ON the Power

Before turning ON the system, establish a protective ground according to Section 2.2 and then plug the enclosed power cord into the wall outlet.

WARNING

Turning ON the power without establishing a protective ground could cause electric shock which might result in severe injury or loss of life. If you do not have a 3-pole (ground-type, 2-pole) wall outlet, be sure to connect the FG terminal on the rear panel or the ground terminal of the enclosed power cord to the ground level before turning ON the system.

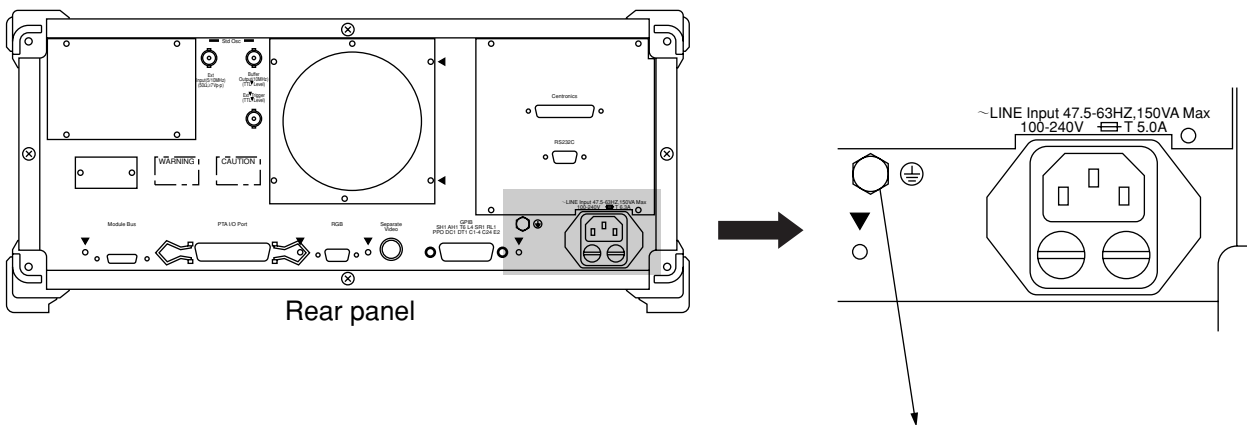

Frame ground (FG) terminal: To prevent electric shock, connect this terminal to the ground level.

CAUTION

An abnormal AC supply voltage could damage the internal circuits.

Before turning ON the system, make sure that the AC supply voltage as specified (nominal value +10/-15 %, 250 V or lower).

3.1 Turning ON the Power

The POWER switch is located at the position shown below. The I and o marks above the POWER switch indicate the power ON and OFF states, respectively.

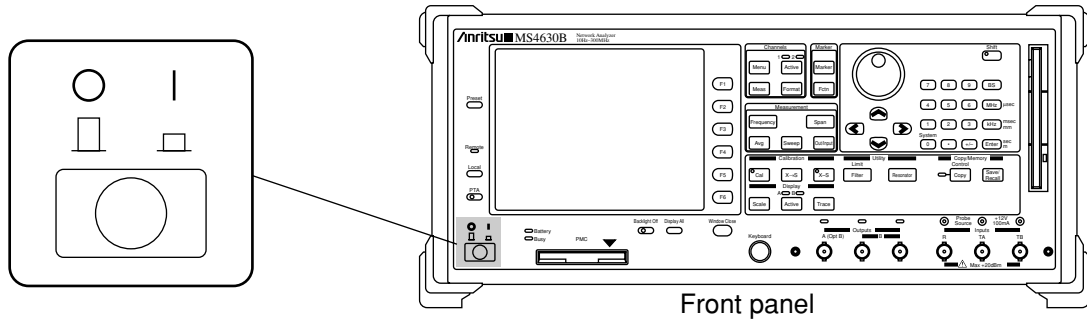

POWER switch

	Power ON	When the pushbutton is pressed so that it is in the lowered position, the system is powered. Power is supplied to all circuits in the system. The system is then ready for use.
	Power OFF	When the pushbutton is pressed a second time so that it is in the raised position, the system is turned off.

<Initial power-on sequence>

Step	Operation	Remarks
1	Connect the FG terminal on the rear panel to the ground level.	When you plug a 3-pole power cord with a ground terminal, the FG terminal need not be connected to the ground level.
2	Measure the AC supply voltage at the wall outlet using an AC voltmeter.	The measured value must be with +10/-15 % of the rated voltage. In Japan, the rated voltage is 100 V.
3	Set the POWER switch on the front panel to the OFF position.	Press the POWER switch so that it is in the raised position.
4	Insert the jack at one end of the power cord into the AC inlet on the rear panel.	Insert the power cord jack as far as it will go.
5	Insert the plug at the other end of the power cord into the wall outlet.	
6	Set the POWER switch on the front panel to the I position.	Press the POWER switch so that it is in the lowered position. Power is supplied to all circuits in the system. The system is ready for use. The display goes on, showing the self-test result. (See the next page.) The fan on the rear panel starts rotating to expel hot air.

Section 3 Basic Operations

3.2 Displaying the Self-Test Result

This system performs a self-test on the internal hardware at power-on and displays the result on the display screen along with the software version information.

The following modules are tested and the result is displayed:

- MAIN CPU
- DISP CPU
- DSP
- LOCAL
- OUTPUT
- RECEIVER (R)
- RECEIVER (TA)
- RECEIVER (TB/opt)

Information about the versions of the following software is displayed:

- OVERALL
- SYSTEM
- MAIN
- DISP
- MEAS
- DSP
- PTA
- PTA USER

Example: The output section is faulty and other sections are normal.

```

CHI-A:150.005MHz
TA/R MK_0 ( 250): -13.5463dB      10dB/  -50.000dB
MAG [ ] [ ] [ ] [ ] [ ] [ ] [ ] [ ] [ ] [ ] [ ] [ ] [ ] [ ] [ ] [ ] [ ] [ ] [ ] [ ]
MEAS (1/2)
TA/R
TB/R
TB/TA
etc.

```

SELF TEST INFORMATION		
MAIN CPU:		Pass
DISP CPU:		Pass
DSP:		Pass
LOCAL:		Pass
OUTPUT:		fail
RECEIVER(R):		Pass
RECEIVER(TA):		Pass
RECEIVER(TB/opt):		Pass
SOFTWARE REV.:	U1.10	May.1997
SYSTEM:	U1.00	May.1997
MAIN:	U1.10	May.1997
DISP:	U1.00	May.1997
MEAS:	U1.10	May.1997
DSP:	U1.10	May.1997
PTA:	U1.00	May.1997
PTA USER:	U1.00	May.1997

SELF TEST INFORMATION screen

3.2 Displaying the Self-Test Result

NOTE:

1. If the self-test result shows any problem or nothing is displayed on the screen, contact Anritsu for repair. The contact addresses and telephone numbers are given at the end of this manual.

When you contact Anritsu for repair, please provide the following information:

- Model and serial number indicated on the rear panel
 - Symptom
 - Name of the person in charge and telephone number
2. Turning on the power with the Preset key pressed down allows you to reset the backup data stored in the internal memory to the settings on shipping.
If backup data has been destroyed due to an incidental problem and therefore the machine does not start operating after power-on, following the above procedure may start the machine.

Section 3 Basic Operations

3.3 Data Displayed on the Screen

If the self-test result is OK, press the WINDOW CLOSE key on the front panel to close the SELF TEST INFORMATION window and display an ordinary measurement screen.

Let's take a look at the data displayed on the screen.

Example 1: Single channel measurement screen

- 1 Indicates that trace A of channel 1 is active and the frequency at the corresponding active marker point is 150.005 MHz.
- 2 Indicates that the active marker of trace A of channel 1 is active marker 0, that it is at the 250th point, and that the value measured at this point (frequency) is -13.5915 dB.
- 3 Indicates that the active marker of trace B of channel 1 is active marker 0, that it is at the 250th point, and that the value measured at this point (frequency) is -17.0609 deg.
- 4 The waveform display scale of trace A of channel 1 is calibrated in 10 dB and the line marked with ▲ indicates -50.000 dB.
- 5 The waveform display scale of trace B of channel 1 is calibrated in 50 deg and the line marked with ▲ indicates 0.000 deg.

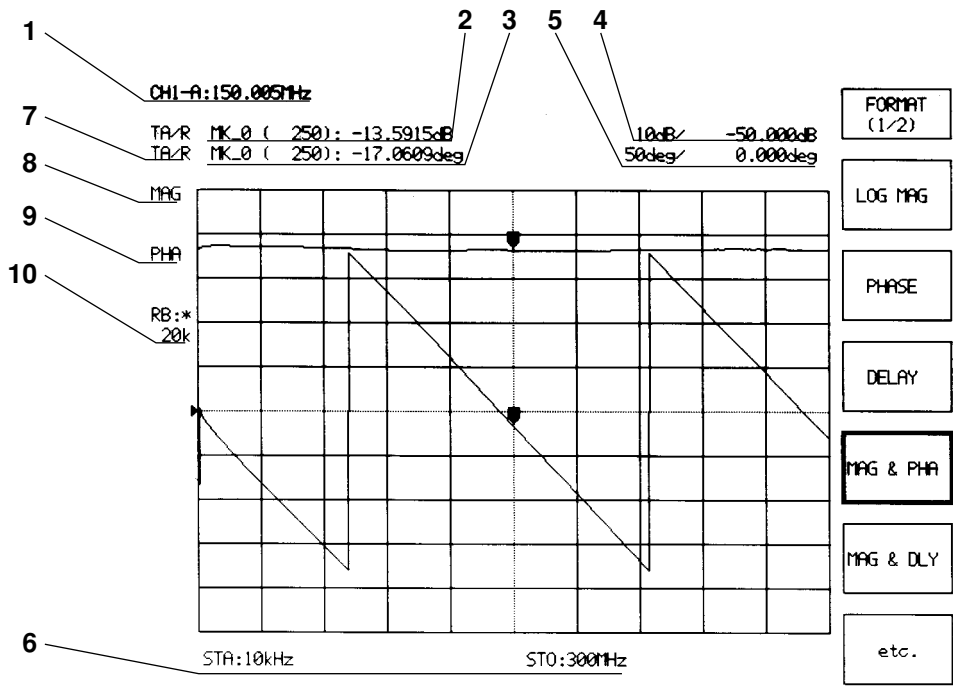

Measurement screen 1

- 6 Indicates that the start frequency is 10 kHz and the stop frequency is 300 MHz.
- 7 Indicates that a ratio computation (TA/R) is performed.
- 8 Indicates that the waveform of trace A of channel 1 indicates a logarithmic magnitude (MAG).
- 9 Indicates that the waveform of trace B of channel 1 indicates a phase (PHA).
- 10 Indicates that the resolution bandwidth is set automatically and the current setting is 20 kHz.

3.3 Data Displayed on the Screen

Example 2: Dual channel measurement screen

- 1 Indicates that trace A of channel 1 is active and the frequency at the corresponding active marker point is 150.005 MHz.
- 2 Indicates that the active marker of trace A of channel 1 is active marker 0, that it is at the 250th point, and that the value measured at this point (frequency) is -0.0020 dB.
- 3 Indicates that the active marker of trace B of channel 1 is active marker 0, that it is at the 250th point, and that the value measured at this point (frequency) is -72 ps.
- 4 The waveform display scale of trace A of channel 1 is calibrated in 10 dB and the line marked with ▲ indicates -50.000 dB.
- 5 The waveform display scale of trace B of channel 1 is calibrated in 100 ns and the line marked with ▲ indicates 0.000 us.
- 6 Indicates that the start frequency of channel 1 is 10 kHz and the stop frequency is 300 MHz.
- 7 Indicates that a ratio computation (TA/R) is performed in channel 1.
- 8 Indicates that the waveform of trace A of channel 1 indicates a logarithmic magnitude (MAG).
- 9 Indicates that the waveform of trace B of channel 1 indicates a group delay (DLY).
- 10 Indicates that the resolution bandwidth of channel 1 is set automatically and the current setting is 20 kHz.
- 11 Indicates that calibration is performed in channel 1.

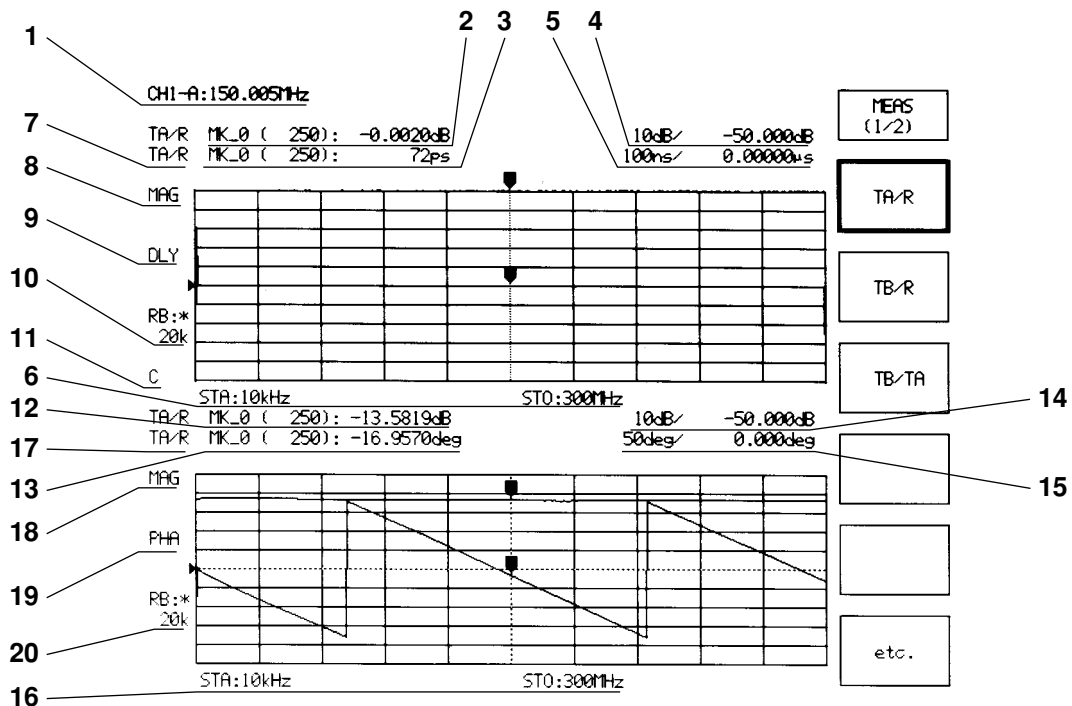

Measurement screen 2

Section 3 Basic Operations

- 12 Indicates that the active marker of trace A of channel 2 is active marker 0, that it is at the 250th point, and that the value measured at this point (frequency) is -13.5819 dB.
- 13 Indicates that the active marker of trace B of channel 2 is active marker 0, that it is at the 250th point, and that the value measured at this point (frequency) is -16.9570 ps.
- 14 The waveform display scale of trace A of channel 2 is calibrated in 10 dB and the line marked with ▲ indicates -50.000 dB.
- 15 The waveform display scale of trace B of channel 2 is calibrated in 50 deg. and the line marked with ▲ indicates 0.000 us.
- 16 Indicates that the start frequency of channel 2 is 10 kHz and the stop frequency is 300 MHz.
- 17 Indicates that a ratio computation (TA/R) is performed in channel 2.
- 18 Indicates that the waveform of trace A of channel 2 indicates a logarithmic magnitude (MAG).
- 19 Indicates that the waveform of trace B of channel 2 indicates a group delay (DLY).
- 20 Indicates that the resolution bandwidth of channel 2 is set automatically and the current setting is 20 kHz.

3.4 Presetting

Pressing the () key and selecting “Yes” from the soft key menu resets the measurement parameters of this system to default values (see Appendix B), excluding the following parameters:

(1) GPIB interface conditions

- GPIB My Address
- Control Function
- Enable Register All
- Terminator
- Time Out

(2) Printer/plotter parameters

- Active Port
- Copy Device
- GPIB Address
- Form Feed

(3) Save/recall parameter

- Drive

(4) Other system parameters

- Marker setting mode
- Impedance measurement method
- Screen color

Table 3-4

Preset	Function
Yes	Performs initialization.
--	
--	
--	
--	
--	

NOTE:

Turning on the power with the Preset key pressed down allows you to reset the backup data stored in the internal memory to the settings on shipping.

If backup data has been destroyed due to an incidental problem and therefore the machine does not start operating after power-on, following the above procedure may start the machine.

Section 3 Basic Operations

3.5 Symbols

Symbol	FULL
0MKR	Zero Marker
A	Output A
ADM	Admittance
ADMT	Admittance
AUTO	Automatic Setting
AVG	Averaging for S/N Improvement
B	Output B
BS	Back Space
CAL	Calibration
CALC	Calculate
CF	Center Frequency
CH1	Channel 1
CH2	Channel 2
CNT	Center Frequency
CONT	Sweep Continue
deg	Degree
DIR	Directry
DLY	Delay
EL	Electric length
EXT	External
Fctn	Function
FREQ	Frequency
FREQ-TB	Frequency Table
F1 to F6	Function Keys No.1 to 6
GND	Ground
IL	Insertion Loss
IMAG	Imaginary part
IMP	Impedance
IMPD	Impedance
ISLN	Isolation
I/F	Interface
LEVEL-TB	Level Table
LIN	Linear
LIN	Linear Magnitude
LOG	Logarithmic
LOGMAG	Logarithmic Magnitude
MAG	Logarithmic Magnitude
MAX	Maximum
MEAS	Measure
MIN	Minimum
MK	Marker

3.5 Symbols

Symbol	FULL
MKR	Marker
MP	Measurement Point
MSG	Message
MT	Main Trace
NWA	Network Analyzer
OFS	Offset
OSC	Oscillator
OSL	Open-Short-Load
PHA	Phase
PMC	Plug-in Memory Card
PARAM	Paramater
PRMS	Paramaters
PTA	Personal Test Automation
R	Reference port
RB	Resolution Bandwidth
RBW	Resolution Bandwidth
RCL	Recall
REAL	Real Part
REF	Reference
RESON	Resonator
RESP	Response
RPL	Ripple
RSV	Request Service
RTL	Return to Local
SEPA	Separated type Video Signal
SPAN	Frequency Span
ST	Sub Trace
STA	Start Frequency
St d	Standard
STO	Stop Frequency
SWT	Sweep Time
TA	Test Port A
TB	Test Port B
TRK	Tracking
UNL	Unlisten
UNT	Untalk
VSWR	Voltage Standing Wave Ratio
Δ MKR	Δ Marker

Section 3 Basic Operations

3.6 List of Soft Key Menu Functions

The following table lists the functions that can be performed by pressing soft keys (F1 to F6):

Panel key	Major function	Soft key menu					
Preset	Initialization	YES					
Local	Setting related to GPIB	GPIB ←	RS232C ←		HARD ←COPY		
PTA	PTA function						
Menu	Measurement channel selection	CH1	CH2	CH1&CH2			COUPLED CHANNEL
Meas	Analysis port selection	TA/R	TB/R	TB/TA			etc
		TA	TB	R			etc
Format	Analysis format selection	LOGMAG	PHASE	DELAY	MAG&PHA	MAG&DLY	etc
		POLAR	IMPD CHART	ADMT CHART	VSWR	more ←	etc
Marker	Marker setting	ON	SCROLL	OFF	REF MKR No	COUPLED MAKER	etc
		NORMAL	ΔMKR	0MKR	MKR CHANGE	MKR LIST	etc
Fctn	Marker function	MK→ MAX	MK→ MIN	MKR→ CF	Δ→SPAN	MK→ OFS	etc
		MKR→ +PEAK	MKR→ -PEAK	TRK +PEAK	TRK -PEAK	TRK OFF	etc
Frequency	Center/start frequency setting	CENTER	START	LOG START			
Span	Span/stop frequency setting	SPAN	STOP	LOG STOP			
Avg	Setting related to S/N improvement	AVERAGE No	SMOOTH- ING	DELAY APERTURE	RBW	AVERAGE FORMAT ←	
Sweep	Setting related to sweep	REPEAT	SINGLE	STOP /CONT	SWEEP TIME	setup ←	etc
		LIST SWEEP LIST	LIST SWEEP EDIT	LIST SWEEP GUARD		FULL/MKR	etc
Out/input	Setting related to input/output	POWER	setup	POWER ←SWEEP	OUTPUT A/B		etc
		RANGE- TA	RANGE- TB	RANGE-R	INPUT ←IMPD	REF IMPD	etc
Cal	Setting related to calibration	*****	*****	*****	*****	setup ←	CAL ON
Scale	Display scale setting	AUTO SCALE	SCALE	OFFSET	OFS LINE	EL DISPLAY	
Trace	Setting related to display	SPLIT DISP	STORAGE	OVER WRITE	GRID ←	←ITEM	etc
		SUB TRACE	MT→ST	MT = ST	MT = MT-ST		etc

3.6 List of Soft Key Menu Functions

Panel key	Major function	Soft key menu					
Filter	Filter analysis function	ANALYSIS	SETUP ←				
Limit	Limit test setting	LINE ENTRY ←	LIMIT TEST	BEEP			
Resonator	Resonator analysis function	ANALYSIS	SETUP ←	RESON1	RESON2		
Control	Hard copy setting	GPIB	RS232C (Opt) ←		HARD COPY ←	BIT MAP ←	
Save/Recall	Saving/recalling setting	INDEX RCL ←	RECALL	SAVE ←	MANAGE ←	DRIVE ←	etc
		TEXT SAVE ←	TITLE ←				etc
System	System parameter setting	USER PRESET ←	CLOCK ←	OPTION ←	COLOR ←	SELF TEST ←	

Section 3 Basic Operations

3.7 The Basics of Key Operations

Three types of keys are used to operate the MS4630B Network Analyzer.

3.7.1 Hard keys (master keys)

Pressing hard keys (master keys) on the front panel performs the associated functions and displays a soft key menu.

Pressing marker keys and hard keys in the Measurement section allows you to enter numeric values such as measurement conditions.

NOTE:

Usually, use numeric keys or the rotary knob to enter numeric values.

3.7.2 Soft keys

A soft key menu appears at the right of the LCD.

Pressing the soft key (F1 to F6) corresponding to a desired menu option performs the associated function.

NOTE:

When there are two or more menu pages, the top label of each menu page indicates a menu page number (e.g., 1/2). Since the system has a menu learning function, pressing a hard key allows you to access the menu page that you accessed most recently.

3.7.3 Operation windows

Keys for displaying windows.

Selecting a menu label containing “←” displays an operation window (hereafter simply called a window).

Setting items that are rarely changed and items that require you to select many parameters are displayed in these windows.

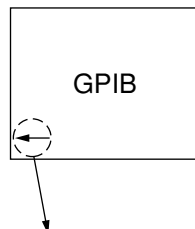

Indicates that selecting this key displays a window.

3.7.4 Operations to Perform in Windows

(1) Selecting setting items

A reverse cursor appears in the window.
 Move the reverse cursor to the setting item you want to change.

Reverse cursor

A character string or value displayed in reverse video can be changed now.
 Move the reverse cursor to the setting item you want to change.
 To move the reverse cursor, use the arrow keys below the rotary knob.

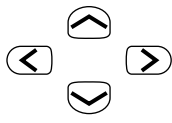

UP and DOWN arrow keys:
 Move the reverse cursor to the preceding or next setting item.

LEFT and RIGHT arrow keys:
 Moves the reverse cursor to the preceding or next option in a setting item.

Indicates that this item is a setting item. To move the reverse cursor to another setting item use the UP and DOWN arrow keys.

- GPIB MY ADDRESS : [1]
- CONTROL FUNCTION:
 - 1. DEVICE 2. CONTROLLER
- ENABLE REGISTER ALL
 - 1. OFF 2. ON
- TERMINATER (for TALKER)
 - 1. LF&EOI 2. CR/LF&EOI
- TIME OUT [20 sec]
- ACTIVE PORT for HARD COPY
 - 1. GPIB 2. RS232C 3. CENTRONICS

To move the reverse cursor to another option in a setting item, use the LEFT and RIGHT arrow keys.
 The underlined options are current choices.

(2) Making a new setting take effect

1) Numeric value

Move the reverse cursor to a desired setting item, then enter a numeric value with numeric keys or rotary knob.

2) Option

Move the reverse cursor to a desired option, then press the Enter key or move the reverse cursor to another option.



Only when an item is enclosed in <> can you move the cursor and make the choice take effect at the same time by entering the item number using numeric keys.

When an item takes effect, it is underlined.

Section 3 Basic Operations

(3) Closing a window

You can close a window by one of the following methods:

- Press another hard key.
- Press the  under the soft key.
- Move the reverse cursor to the upper right corner of the window and press the  key.
(If the window is in a deep layer, the window in a layer which is one layer shallower than the current will appear.)

3.7.5 Channels and Traces

This system has two measurement channels: channel 1 (CH1) and channel 2 (CH2).

“Channel” refers to a set of internal hardware resources necessary for performing measurements. For example, settings of a measurement frequency and an analysis port are included in the settings of a channel. Since there are two channels, two measurements can be performed using one measuring device. *1

One channel has two traces: trace A (TR_A) and trace B (TR_B).

“Trace” refers to the displayed result of measurement performed in a channel. Two traces appear only when a measurement result is displayed with respect to two parameters such as “magnitude” and “phase,” allowing you to make various settings for each trace.

For example, a marker setting is included in a trace setting.

As stated above, this system allows you to obtain a maximum of four traces for two channels. *2

NOTE:

- *1 When a channel contains only one hardware resource, two measurements cannot be performed at the same time. They must be performed one at a time (e.g., frequency, then output level).
- *2 However, the limit test function may come under certain restrictions (See 6.3.1).

Section 4

Selecting Measurement Items (Channels Group)

This section explains how to operate keys for selecting measurement items. These keys are in the Channels section on the front panel.

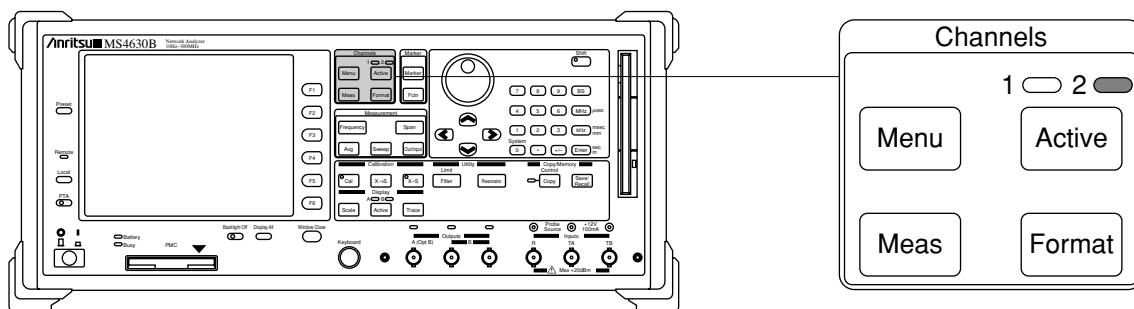

Front panel

Major functions

- Measurement channels (CH1, CH2)
- Selection of active channel
- Setting of analysis port
- Selection of analysis (display) format

4.1	Selecting a Measurement Channel (Menu)	4-2
4.1.1	Selecting a measurement channel	4-2
4.1.2	Coupled Channel	4-3
4.2	Active Channel (Active)	4-4
4.3	Selecting an Analysis Port (Meas)	4-4
4.3.1	Measuring a ratio (TA/R, TB/R, TB/TA)	4-4
4.3.2	Measuring a level (TA, TB, R)	4-5
4.3.3	Notes on level measurement	4-5
4.4	Selecting Measurement Items (Format)	4-6
4.4.1	Selecting an analysis format	4-6
4.4.2	Selecting an impedance marker display mode	4-7
4.4.3	Selecting an admittance marker display mode	4-8
4.4.4	Phase offset	4-8

Section 4 Selecting Measurement Items (Channels Group)

4.1 Selecting a Measurement Channel (Menu)

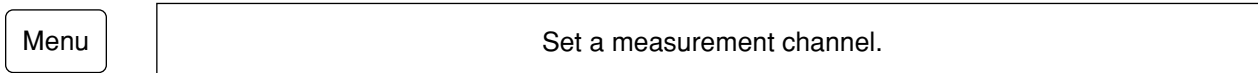

MENU	Description of function
CH1	Selects CH1 as a measurement channel.
CH2	Selects CH2 as a measurement channel.
CH1&CH2	Selects CH1 and CH2 as measurement channels (Dual channel measurement.)
--	
--	
COUPLED CHANNEL	Couples measurement conditions of CH1 and CH2 (when set ON.)

4.1.1 Selecting a measurement channel

Press the  key and select a measurement channel from the soft key menu.

4.1 Selecting a Measurement Channel (Menu)

4.1.2 Coupled Channel

Press the  key and select a channel coupling mode from the soft key menu “COUPLED CHANNEL.” When the channels are coupled, setting an interlinked item for the channel in the active status will also result in setting of the same item for the channel in the non-active status. The table below shows the setup items which can be interlinked by this function by key group.

Channels group	Analysis port Analysis format Phase offset
Measurement group	Frequency Output level Power sweep Input range Input impedance Averaging RBW Smoothing Delay aperture Sweep time Sweep control Marker sweep Number of measurement points Break point
Display group	Active trace Electrical length Sub-trace
Calibration group	CAL ON/OFF CAL element data fetching start Normalize ON/OFF Start of fetching of the reference data for normalization
Utility group	Filter analysis function Resonator analysis function

The Marker, Copy & Memory and System groups have no target functions.

Section 4 Selecting Measurement Items (Channels Group)

4.2 Active Channel (Active)

Select an active channel using the “Active” key

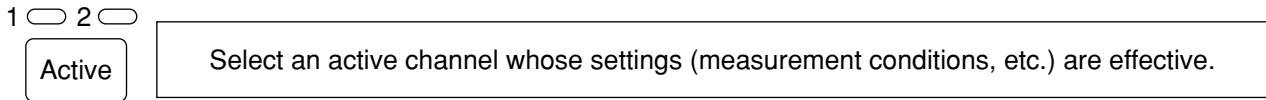

Single channel (CH1 or CH2)

Pressing the  key toggles between CH1 and CH2.

Dual channel (CH1 and CH2)

Pressing the  key selects a channel (active channel) whose settings (measurement conditions, etc.) are effective.

NOTE:

A channel whose settings (measurement conditions, etc.) are effective is called an active channel. The lamp lit above the  key indicates the active channel.

4.3 Selecting an Analysis Port (Meas)

Press the  key and select an analysis port from the soft key menu.

4.3.1 Measuring a ratio (TA/R, TB/R, TB/TA)

 Select an analysis port.

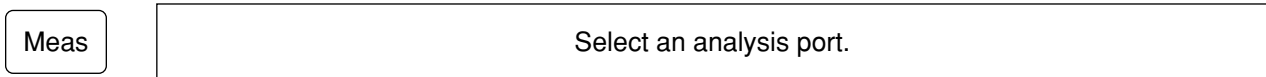

MEAS (1/2)	Description of function
TA/R	Measures the ratio (TA/R) of the signal input to input port R to the signal input to input port TA.
TB/R	Measures the ratio (TB/R) of the signal input to input port R to the signal input to input port TB.
TB/TA	Measures the ratio (TB/TA) of the signal input to input port TA to the signal input to input port TB.
--	
--	
etc.	Switches to the next menu.

4.3.2 Measuring a level (TA, TB, R)

MEAS (2/2)	Description of function
TA	Measures the level of the signal input to input port TA.
TB	Measures the level of the signal input to input port TB.
R	Measures the level of the signal input to input port R.
--	
--	
etc.	Returns to the previous menu.

NOTE:

The input port TB is an optional unit.

When this unit is not installed, setting related to input port TB cannot be made.

The setting of analysis format and display scale can be made independently for each analysis port selected.

4.3.3 Notes on level measurement

When TA, TB, or R is selected, meaningful waveform data is not displayed if an analysis format other than LOGMAG and LINMAG is selected.

The phase of signal is not measured on the level measurement, then the function which needs the phase information (Averaging and CAL except Normalize) is not operated.

Section 4 Selecting Measurement Items (Channels Group)

4.4 Selecting Measurement Items (Format)

Press the **Format** key to select measurement items from the soft key menu.

4.4.1 Selecting an analysis format

Press the **Format** key to select measurement items from the soft key menu and MORE window.

(1) Selection using the soft key menu.

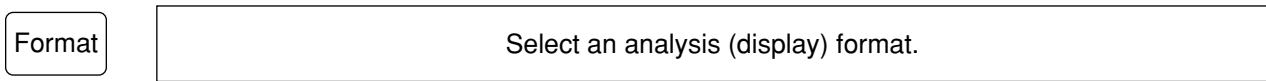

Format (1/2)	Description of function (unit)
LOG MAG	Displays the analysis result with a logarithmic magnitude. (dB)
PHASE	Displays the analysis result with a phase. (deg)
DELAY	Displays the analysis result with a group delay. (sec)
MAG & PHA	Displays the analysis result with a logarithmic magnitude and phase. (dB), (deg)
MAG & DLY	Displays the analysis result with a logarithmic magnitude and group delay. (dB), (sec)
etc.	Switches to the next menu.

Format (2/2)	Description of function (unit)
POLAR	Displays the analysis result with a polar chart (polar coordinates). (unit less number)∠(deg)
IMPD CHART	Displays the analysis result with an impedance chart.
ADMT CHART	Displays the analysis result with an admittance chart.
VSWR	Displays the analysis result with VSWR. (unit less number)
more	Displays the window for selecting another format.
etc.	Returns to the previous menu.

NOTE :

- For the unit of measure of marker display values, see IMPD MKR FORMAT and ADMT MKR FORMAT. The same waveform as that of the POLAR format is displayed.
- No correct measurement result can be obtained for the analysis format of group delay with the horizontal axis being the logarithm frequency (LOG).

4.4 Selecting Measurement Items (Format)

(2) Selection using the window.

Select other analysis format.

Effective key: Ten-key, rotary knob (◀) (▶) key

-MORE- WINDOW

FORMAT:

- | | |
|-----------------------|---|
| 01.<LIN MAG> | Displays the linear magnitude (unit less number). |
| 02.<LIN & PHA> | Displays both the linear magnitude and phase (unit less number), (deg). |
| 03.<LIN & DLY> | Displays both the linear magnitude and group delay (unit less number), (sec). |
| 04.<REAL> | Displays the real number component (unit less number). |
| 05.<IMAG> | Displays the imaginary number component (unit less number). |
| 06.<REAL & IMAG> | Displays the real and imaginary number components (unit less number), (unit less number). |
| 07.<LOGZ> | Displays the impedance in logarithm (Ω). |
| 08.<LOGZ & θ > | Displays the impedance and impedance phase (Ω), (deg). |
| 09.<Q> | Displays Q (unit less number). |
| 10.<LOGZ & Q> | Displays the impedance in logarithm and Q (Ω), (unit less number). |

IMPD MKR FORMAT for IMPD CHART:

ADMT MKR FORMAT for ADMT HART:

PHASE OFFSET:

Note:

Enter two-digit numeric to make a selection using the ten-key.

Example) Enter “0” and “7” to select LOG Z.

Pressing the Enter key is not required when using the ten-key for data entry.

4.4.2 Selecting an impedance marker display mode

When the analysis format is “IMPD CHART”, set the display mode of the marker value.

Effective key: Rotary knob (◀) (▶) key

MORE- WINDOW

FORMAT~

IMPD MKR FORMAT for IMPD CHART:

- | | |
|--------------------|--|
| Z $\angle\theta$: | The absolute value and phase angle of impedance |
| Rs/Ls, Cs: | Equivalent series resistance and equivalent series inductance, or equivalent series capacity |
| Q/D: | Q and $\tan \delta$ of the resonance circuit |



ADMT MKR FORMAT for ADMT CHART:~

PHASE OFFSET:~

Section 4 Selecting Measurement Items (Channels Group)

4.4.3 Selecting an admittance marker display mode

When the analysis format is “ADMT CHART”, set the display mode of the marker value.

Effective key: Rotary knob   key

-MORE- WINDOW

FORMAT~

IMPD MKR FORMAT for IMPD CHART:~

ADMT MKR FORMAT for ADMT CHART:

Y∠θ: The absolute value and phase angle of admittance

Rp/Lp, Cp: Equivalent parallel resistance and equivalent parallel inductance, or equivalent parallel capacity

Q/D: Q and tan δ of the resonance circuit

PHASE OFFSET:~

4.4.4 Phase offset

Press the  key and set an offset value in the MORE window.

Effective key: Ten-key, rotary knob

-MORE- WINDOW

FORMAT~

IMPD MKR FORMAT for IMPD CHART:~

ADMT MKR FORMAT for ADMT CHART:~

PHASE OFFSET: When the format is “PHASE” or the impedance phase is “θ,” set a phase offset.

Setting range: ±180 deg

Section 5 Selecting Measurement Parameters (Measurement Group)

This section explains how to select measurement parameters.

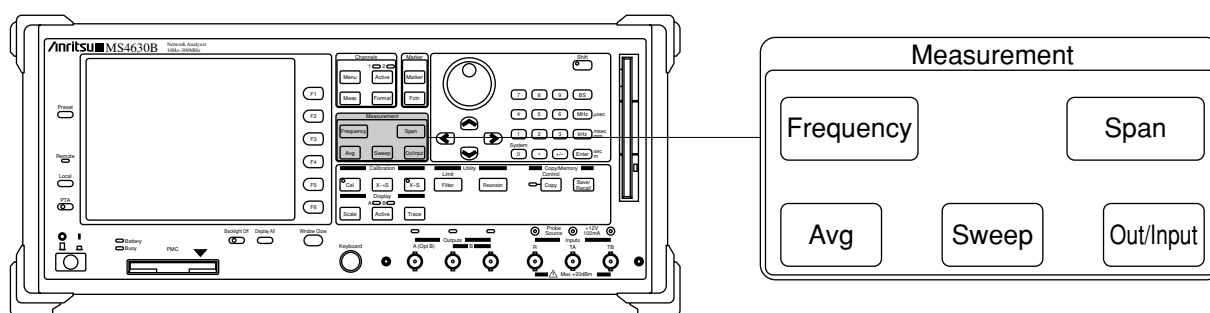

Front panel

Major functions

- Frequency setting
- Averaging, smoothing, resolution bandwidth, and delay aperture setting
- Setting of sweep control, sweep time, number of sweep points, list sweep
- Setting of input range and impedance
- Setting of output power and power sweep

5.1	Setting a Frequency (Frequency, Span)	5-2
5.2	Settings Related to Input/Output (Out/Input)	5-3
5.2.1	Output level	5-3
5.2.2	Switching between output ports A and B	5-4
5.2.3	Power sweep	5-4
5.2.4	Input range	5-5
5.2.5	Input impedance	5-5
5.2.6	Reference impedance	5-6
5.3	Improving the S/N Ratio and Setting an Delay Aperture (Group Delay Measurement) (Avg)	5-7
5.3.1	Averaging	5-7
5.3.2	RBW	5-8
5.3.3	Smoothing	5-8
5.3.4	Delay aperture	5-9
5.4	Settings Related to Sweep	5-10
5.4.1	Sweep time	5-10
5.4.2	Sweep control	5-10
5.4.3	Number of measurement points	5-11
5.4.4	Breakpoints	5-11
5.4.5	Sweep by external trigger	5-12
5.4.6	List sweep	5-13
5.4.7	Marker sweep	5-19

Section 5 Selecting Measurement Parameters (Measurement Group)

5.1 Setting a Frequency (Frequency, Span)

Set a measurement frequency using the Frequency and Span keys.

Effective key: Ten-key, rotary knob

Frequency	Set a center or start frequency.
---	----------------------------------

FREQ	Description of function
CENTER	Selects the center span setting mode, allowing you to set a center frequency. (0 to 300 MHz)
START	Selects the start-stop setting mode, allowing you to set a start frequency. (0 to 300 MHz)
LOG START	Selects the log frequency setting mode, allowing you to set a log start frequency. *1
--	
--	
--	

Span	Set a frequency span or stop frequency.
--	---

SPAN	Description of function
SPAN	Selects the center span setting mode, allowing you to set a frequency span. (0 to 300 MHz)
STOP	Selects the start-stop setting mode, allowing you to set a stop frequency. (0 to 300 MHz)
LOG STOP	Selects the log frequency setting mode, allowing you to set a log stop frequency. *1
--	
--	
--	

NOTE:

*1 In the log frequency setting mode, frequencies that can be set are 10 Hz, 100 Hz, 1 kHz, 10 kHz, 100 kHz, 1 MHz, 10 MHz, 100 MHz, and 300 MHz.
A frequency range can be set independently for each setting mode.

5.2 Settings Related to Input/Output (Out/Input)

Press the  key and make input-/output-related settings using the soft key menu and window.

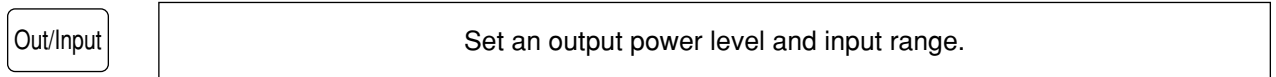

5.2.1 Output level

(1) Setting of the output level

Use the soft key menu shown below to set the output level.

Effective key: Ten-key, rotary knob

OUTPUT (1/2)	Function Detail
POWER setup POWER SWEEP OUTPUT A/B -- etc.	Enables setting of the output level. *1 Switches the display to the next menu.

NOTE:

*1 The output level depends on the output level related setting shown below. See NOTE 1 of 5.2.1 (2).

(2) Output level related setting

Use the soft key menu or the window shown below to execute the output level related setting.

Effective key: Ten-key, rotary knob

OUTPUT (1/2)	Function Detail
POWER setup POWER SWEEP OUTPUT A/B -- etc.	Displays the window to execute other output level related setting. *1 Switches the display to the next menu.

-OUTPUT PWR SETUP- WINDOW

- SOURCE POWER: Allows you to set the internal signal source level. (0 to +21 dBm)
- OUTPUT ATT: Allows you to set the attenuation of the output attenuator (optional unit). This is not displayed when no optional unit is installed.
- OFFSET: Allows you to set the apparent offset of the output power. The actual output power does not change.

Section 5 Selecting Measurement Parameters (Measurement Group)

NOTE:

- *1 • The relationship among the above values can be expressed as follows (when output port A is selected):

$$\text{Output power} = (\text{Source power}) - (\text{Output attenuation}) + (\text{Offset})$$
 When output port B (2-branch output) is selected, 6 dB is subtracted from the output power. When output port B (3-branch output : option 14) is selected, 9.5 dB is subtracted from the output power.
- When the output attenuator (optional unit) is not installed, the output attenuation is assumed to be 0 dB.

5.2.2 Switching between output ports A and B

Press the Out/In key and select OUTPUT A/B from the following soft key menu to switch between output ports A and B:

OUTPUT (1/2)	Description of function
POWER setup	
POWER SWEEP	
OUTPUT A/B	
--	
etc.	
	Allows you to switch between output ports A and B (branch outputs) on the front panel.
	Switches to the next menu.

5.2.3 Power sweep

Press the Out/In key and select POWER SWEEP from the following window:

Effective key: Ten-key, rotary knob

OUTPUT (1/2)	Description of function
POWER setup	
POWER SWEEP	
OUTPUT A/B	
--	
etc.	
	Displays the window for setting power sweep.
	Switches to the next menu.

-POWER SWEEP- WINDOW

- | | |
|---------------------------------------|---|
| <input type="checkbox"/> POWER SWEEP: | Turns ON/OFF power sweep. |
| <input type="checkbox"/> START POWER: | Allows you to set the output power at the sweep start frequency. |
| <input type="checkbox"/> END POWER: | Allows you to set the output power at the sweep stop frequency. |
| <input type="checkbox"/> STEP: | Allows you to set an output power change step.
The start power changes to the stop power in specified steps. |

5.2 Settings Related to Input/Output (Out/Input)

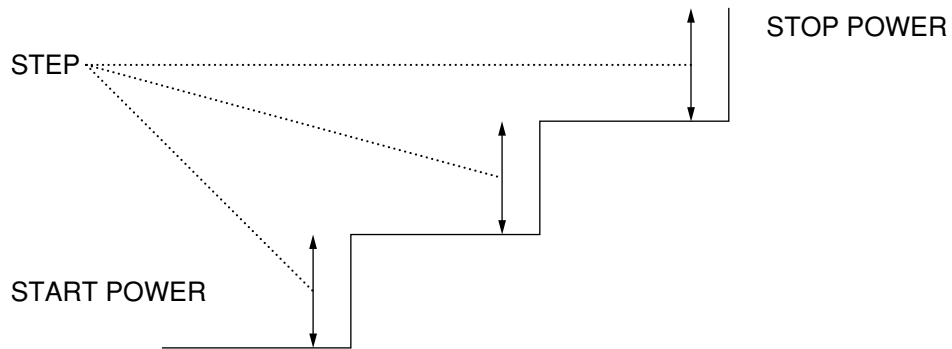

5.2.4 Input range

Press the Out/Input key and make the settings related to the input range using the following soft key menu and window.

Effective key: Ten-key, rotary knob

INPUT (2/2)	Description of function
RANGE-TA	Allows you to set the input range of input port TA. (0/+20 dBm) *1
RANGE-TB	Allows you to set the input range of input port TB. (0/+20 dBm) *1
RANGE-R	Allows you to set the input range of input port R. (0/+20 dBm) *1
INPUT IMPD	
REF IMPD	
etc.	Returns to the previous menu.

NOTE:

Input port TB is an optional unit. When it is not installed, settings related to input port TB cannot be made.

*1 Input impedance is 1 MΩ, use 0 dBm range.

5.2.5 Input impedance

Press the Out/Input key and set an input impedance using the following soft key menu and window:

Effective key: Ten-key, rotary knob ← → key

INPUT (2/2)	Description of function
RANGE-TA	
RANGE-TB	
RANGE-R	
INPUT IMPD	Displays the window for setting an input impedance.
REF IMPD	
etc.	Returns to the previous menu.

-INPUT IMPEDANCE- WINDOW

- IMPEDANCE(TA)
- IMPEDANCE(TB)
- IMPEDANCE(R)

Set the input impedance of each input port to 50/75 Ω or 1 MΩ.

The 75 Ω input requires a conversion adapter (MA4605A).

Section 5 Selecting Measurement Parameters (Measurement Group)

5.2.6 Reference impedance

Press the  key and select REF IMPD from the following soft key menu to set the reference impedance:

Effective key: Ten-key, rotary knob

INPUT (2/2)	Description of function
RANGE-TA RANGE-TB RANGE-R INPUT IMPD REF IMPD etc.	Allows you to set a reference impedance. (0.1 to 10000.0 Ω) Returns to the previous menu.

5.3 Improving the S/N Ratio and Setting an Delay Aperture (Group Delay Measurement)(Avg)

5.3 Improving the S/N Ratio and Setting an Delay Aperture (Group Delay Measurement) (Avg)

Press key and make settings using the following soft key menu and window:

Avg	Set averaging, smoothing, delay, aperture, and resolution bandwidth.
-----	--

5.3.1 Averaging

Press the key and make averaging-related settings using the following soft key menu and window:

(1) Set the frequency of sweep required to exevute the averaging process.

Effective key: Ten-key, rotary knob

AVG	Description of function
AVERAGE No SMOOTHING DELAY APERTURE RBW AVERAGE FORMAT --	Allows you to set a number of sweeps to be performed for averagingn (1 to 1000.) Displays the window for setting an averaging type.

(2) Set the type of the averaging process.

Effective key: Ten-key, rotary knob key

-AVG FORMAT- WINDOW

AVERAGE TYPE

SUM: Averages measured points for each sweep. *1

MAX: Holds the maximum measured point. (MAX HOLD) *2

MIN: Holds the minimum measured point. (MIN HOLD) *2

NOTE:

*1 Real parts and imaginary parts of measured values as vector quantity are averaged as many times as the number of measurement to get real part data and imaginary part data.

When the analysis port is TA, TB, or R (level measurement), the signal phase cannot be measured properly, resulting in an indefinite average and abnormal operation.

*2 The measured value whose absolute value is maximum (minimum) is used as a vector quantity.

Normal operation is assured if the analysis port is TA, TB, or R (level measurement).

Section 5 Selecting Measurement Parameters (Measurement Group)

5.3.2 RBW

Set the resolution bandwidth.

Effective key: Ten-key, rotary knob

AVG	Description of function
AVERAGE No SMOOTHING DELAY APERTURE RBW AVERAGE FOR- MAT --	Allows you to set a resolution bandwidth. *1

NOTE:

*1 One of the following values can be set for “RBW”:

3 Hz, 10 Hz, 30 Hz, 100 Hz, 300Hz, 500 Hz, 1 kHz, 2 kHz, 3 kHz, 4 kHz, 5 kHz, 10 kHz, 20 kHz, and AUTO

In the RBW auto-setting mode, the measurable minimum resolution bandwidth is automatically selected according to the current sweep time.

To automatically set the RBW, type [0] and [Enter].

5.3.3 Smoothing

Execute the moving average process required to smooth the waveform.

Effective key: Ten-key, rotary knob

AVG	Description of function
AVERAGE No SMOOTHING DELAY APERTURE RBW AVERAGE FOR- MAT --	Performs moving averaging for smoothing waveforms (0 to 50%.)

NOTE:

The measurement result around the start and stop frequencies, for which the moving averaging process cannot be performed, is displayed as invalid data.

The invalid data is usually displayed at the bottom of the screen.

However, if the analysis format is POLAR, IMPD CHART, or ADMT CHART, the invalid data is displayed at the center of a circle.

5.3 Improving the S/N Ratio and Setting an Delay Aperture (Group Delay Measurement)(Avg)

5.3.4 Delay aperture

Set the aperture for the group delay measurement.

Effective key: Ten-key, rotary knob

AVG	Description of function
AVERAGE No SMOOTHING DELAY APERTURE RBW AVERAGE FORMAT --	Allows you to set an aperture for delay (group) delay measurement. *1

NOTE:

*1 Specify an aperture with a ratio (%) to the frequency span. The setting range is from 0.2 % to 20 %. The minimum value and resolution depend on the following expression:

$$\text{Minimum value and resolution} = 2/(\text{Number of measure points}) \times 100 (\%)$$

NOTE:

The group delay measurement is calculated using the measurement data obtained at the two measurement points specified in the delay aperture parameter.

Therefore, the measurement result is displayed only for frequencies at which these two measurement points can co-exist. Since this condition is not met around the start and stop frequencies, the result is displayed as invalid data.

This invalid data becomes the minimum value of the measurement data.

Section 5 Selecting Measurement Parameters (Measurement Group)

5.4 Settings Related to Sweep

Press the **Sweep** key and make settings related to sweep using the displayed soft key menus and windows.

Sweep	Set sweep control, sweep time, and the number of sweep points.
--------------	--

5.4.1 Sweep time

Press the **Sweep** key and select SWEEP TIME from the soft key menu to set a sweep time.

Effective key: Ten-key, rotary knob

SWEEP (1/2)	Description of function
REPEAT SINGLE STOP/CONT SWEEP TIME setup etc	Allows you to set a sweep time (0 to 27.5 hours.)

- To specify “AUTO” for “SWEEP TIME,” enter 0 (sec).
 When AUTO is specified for “SWEEP TIME,” the fastest sweep time is automatically set according to the current RBW, number of sweep points, and number of traces.

5.4.2 Sweep control

Press the **Sweep** key and make settings related to sweep control using the displayed soft key menu and window.

SWEEP (1/2)	Description of function
REPEAT SINGLE STOP/CONT SWEEP TIME setup etc	Sweeps repetitively. Sweeps only once. Stops (STOP) or restarts (CONT) sweeping.

5.4.3 Number of measurement points

Press the  key and specify a number of measurement points using the displayed soft key menu and window.
Effective key: Ten-key, rotary knob

SWEEP (1/2)	Description of function
REPEAT SINGLE STOP/CONT SWEEP TIME setup etc	Displays the window for setting sweep control parameters.

-SETUP- WINDOW

- MEASURE POINTS: Set the number of measure points. Specify one of 11, 21, 51, 101, 251, 501, and 1001.
- BREAK POINTS: ~
- TRIGGER SOURCE: ~
- EXT TRIGGER: ~
- EXT TRIGGER SLOPE: ~

5.4.4 Breakpoints

Press the  key and make sweep-related settings using the displayed soft key menu and window.
Effective key: Ten-key, rotary knob

SWEEP (1/2)	Description of function
REPEAT SINGLE STOP/CONT SWEEP TIME setup etc	Displays the window for setting sweep control parameters.

-SETUP- WINDOW

- MEASURE POINTS: ~
- BREAK POINTS: Set the number of points at which sweep is interrupted. (1 to 1001)
- TRIGGER SOURCE: ~
- EXT TRIGGER: ~
- EXT TRIGGER SLOPE: ~

Section 5 Selecting Measurement Parameters (Measurement Group)

5.4.5 Sweep by external trigger

Press the **Sweep** key and make sweep-related settings using the displayed soft key menu and window.

Effective key: Ten-key, rotary knob **<** **>** key

SWEEP (1/2)	Description of function
REPEAT SINGLE STOP/CONT SWEEP TIME setup etc	Displays the window for setting sweep control parameters.

-SETUP- WINDOW

- MEASURE POINTS: ~
- BREAK POINTS: ~
- TRIGGER SOURCE: Specify an event (trigger) that causes sweep to start.
When an internal trigger is specified, the next sweep is started by an event that occurs in the system. When an external trigger is specified, the next sweep is started by the control signal input to the EXT TRIG IN terminal.
- EXT TRIGGER: Specify a type of sweep started by an external trigger.
 - NORMAL: Sweeps only once when an event is caused by the control signal.
 - STEP: Measures one point when an event is caused by the control signal.
 - STATE: Stops or restarts sweep according to the state of the control signal.
Low level input: Stop High level input: Restart
- EXT TRIGGER SLOPE: Specify an edge (leading or trailing) of the control signal that causes an event.

5.4.6 List sweep

What is list sweep?

The device stores in itself the measurement conditions corresponding to the measurement points on the frequency axis (horizontal axis) in the measurement screen, as data tables. In the actual sweep measurement, the device refers to the data in these tables to set the conditions.

There are the following four types of data tables that store such measurement conditions:

- Frequency data table
- Level data table (used at the time of power sweep)
- RBW data table
- User wait data table

NOTE:

These data tables exist independently for each measurement channel.

If both measurement channels are to be used in the same measurement conditions, i.e., if the coupled channel function is turned ON, only the data tables for the active channel are used for the measurement.

If a measurement parameter is changed, a value calculated inside the device according to the value of the said measurement parameter is reflected in these data tables.

If, for example, a frequency parameter such as the center frequency or the frequency span is set, a calculation is carried out based on these frequency parameters to equalize the frequency intervals between the measurement points in the case of linear sweep, the result of which is reflected at each point in the frequency data table.

Thus, changing the measurement parameters normally creates these data tables. However, regardless of the values of these measurement parameters, you can change the measurement condition at any given point in a data table to carry out the measurement.

List sweep refers to sweeping according to a condition that a user has arbitrarily set for each measurement point by changing the said condition data in a data table.

The user does not need to set whether list sweep is done or not.

Modifying, changing, and registering data in the data table edit screen (LIST SWEEP EDIT menu) will cause the sweep to be performed using the new measurement conditions in the next measurement.

These data tables can be saved to or recalled as files from auxiliary storage media such as floppy disks, internal memory, and memory cards.

Section 5 Selecting Measurement Parameters (Measurement Group)

The following explains the details of measurement condition data tables.

(1) Frequency data table

A frequency data table stores the data of measurement frequencies corresponding to each measurement point (X-axis).

Normally, when a measurement parameter related to frequencies such as the center frequency or the frequency span is set, the data for all the measurement points at that time is automatically created inside the device.

(2) Level data table

A level data table stores the data of output power corresponding to each measurement point (Y-axis).

The data in this table is used to carry out power sweep.

Normally, when a measurement parameter related to the power sweep function is set, the data for all the measurement points at that time is automatically created inside the device.

(3) RBW data table

A RBW data table stores the RBW values corresponding to each measurement point.

Normally, when a measurement parameter such as RBW and the sweep time is set, the data for all the measurement points at that time is automatically created based on the same RBW value.

(4) User wait table

A user wait table stores the user wait time corresponding to each measurement point.

Normally, when a measurement parameter such as the sweep time and RBW is set, the wait time elapsing between switching the measurement frequency at each measurement point and starting the measurement is set as the same value for between all the measurement points.

The user wait function allows you to set any additional wait time for any given point in addition to the preset wait time.

All the initial values of the user wait time are set to 0 seconds.

NOTE:

Changing a measurement parameter automatically updates the contents of these data tables that generally store the measurement conditions. Therefore, changing a data table for the purpose of list sweep and then setting a related measurement parameter again will update the data tables.

To prevent these tables from being updated when a measurement parameter is set, use the F3: LIST SWEEP GUARD function in the SWEEP (2/2) menu.

5.4 Settings Related to Sweep

SWEEP (2/2)	Description of function
LIST SWEEP LIST LIST SWEEP EDIT LIST SWEEP GUARD -- FULL/MKR etc.	Displays the contents of tables of measurement conditions for list sweep in a list. Returns to the previous menu.

-LIST SWEEP LIST- WINDOW

<< LIST SWEEP TABLE (CH*) >>

Point	Frequency	RBW	User Wait	POWER
0	10.000 000kHz	20kHz	0us	*****
1	20.000 000kHz	20kHz	0us	*****
2	30.000 000kHz	20kHz	0us	*****
•	•	•	•	•
•	•	•	•	•
•	•	•	•	•

Description of display contents

The measurement condition tables for list sweep are displayed in a list for each measurement point number.

Point:

Indicates the measurement point number on the frequency axis in the measurement screen. The leftmost point of the screen represents Point 0. The rightmost point of the screen represents (the number of measurement points - 1).

To check the number of measurement points, press the F5: Setup key in the SWEEP (1/2) menu to open a window. The initial value of the number of measurement points is 501.

Frequency:

Indicates the measurement frequency corresponding to each measurement point.

RBW:

Indicates the RBW (resolution bandwidth) corresponding to each measurement point.

User Wait:

Indicates the user wait time corresponding to each measurement point.

Section 5 Selecting Measurement Parameters (Measurement Group)

Power:

Indicates the output power corresponding to each measurement point.

This item is used if the power sweep function is turned ON. Otherwise, this item indicates ***** and cannot be changed.

Description of operation

The list screen, when brought up, shows the data entry area, "LIST CURRENT POINT:" (in which a numeric value can be entered) at the bottom.

This data entry area shows the current point (the measurement point number at which the measurement conditions can be changed).

The current point also matches the measurement point number enclosed inside a square in the list screen.

Use the data knob, Up/Down keys, and ten-key pad to change the current point. Then, the indication in the list screen changes according to this change.

The current point may be set in the range from 0 through 1000.

5.4 Settings Related to Sweep

SWEEP (2/2)	Description of function
LIST SWEEP LIST LIST SWEEP EDIT LIST SWEEP GUARD -- FULL/MKR etc.	Brings up a window to change the contents of tables of measurement conditions for list sweep. Returns to the previous menu.

-LIST SWEEP EDIT- WINDOW

- POINT: Sets the current point.
- CURRENT FREQUENCY: Registers the frequency at the current point.
- STEP: Adds the frequency set in this item (the increment) to the frequency at the current point, and registers it as the frequency at the next point.
The frequencies up to the one shown in the "END" item below can be repetitiously registered in the same way. (NOTE 1)
- END: Specifies the last frequency in the repetitious registration described above.
- RBW: Registers the RBW at the current point.
The RBW is not automatically specified.
- USER WAIT: Registers the user wait time at the current point.
0.01msec to 7200sec
- POWER: Registers the output power at the current point.
This registration is enabled only when the power sweep is turned ON.
- ENTRY: Updates the data tables according to the registered conditions.

NOTE1:

If the "STEP" frequency is set to 0 Hz, only the frequency at the current point is updated.

NOTE:

Unless the update is performed after the conditions are registered, the registered contents are not reflected in the data tables.

Section 5 Selecting Measurement Parameters (Measurement Group)

The following describes the various ways of performing the update.

1. REPLACE

Replaces the condition at the current point with a new ones.

2. INSERT

Inserts a new condition at the current point. The old data at the current point as well as the data at any following points is accordingly moved down.

The data at the final point will be discarded.

3. DELETE

Deletes the data at the current point. The data at any following points is accordingly moved up.

The data at the new final point is set to the same value as the data at the old final point.

4. READY

Indicates that the device is ready to perform the edit.

SWEEP (2/2)	Description of function
LIST SWEEP	
LIST	
LIST SWEEP	
EDIT	
LIST SWEEP	
GUARD	Prevents the measurement condition tables for list sweep from being updated even if the measurement parameters are changed.
--	
FULL/MKR	
etc.	Returns to the previous menu.

LIST SWEEP GUARD function

ON: Does not update the measurement condition tables even if the measurement parameters are changed.

The screen shows "GUARD ON".

OFF: Updates the measurement condition tables accordingly if the measurement parameters are changed (Initial state).

5.4.7 Marker sweep

Press the SWEEP switch to display the software key menu to switch between marker sweep and full sweep.

SWEEP (2/2)	Description of function
LIST SWEEP	
LIST	
LIST SWEEP	
EDIT	
LIST SWEEP	
GUARD	
--	
FULL/MKR	Switches between full-band sweep (FULL) and marker sweep (MKR).
etc.	Returns to the previous menu.

The marker sweep sweeps the frequency band between the active and reference markers.

Section 5 Selecting Measurement Parameters (Measurement Group)

Section 6 Display (Display Group)

This section explains various functions for displaying easy-to-read measurement waveforms.

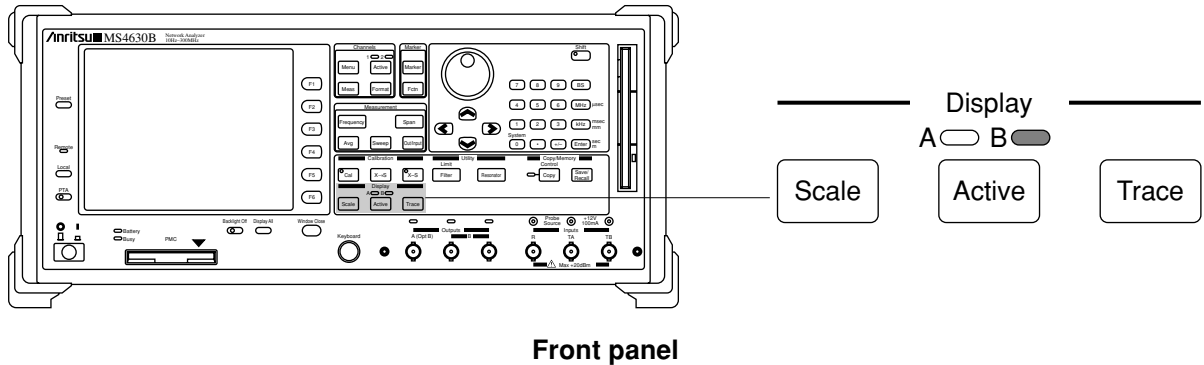

Major functions

- Setting a trace scale
- Setting trace and scale grid display types
- Selecting display items
- Subtrace function

6.1	Active Trace (Active)	6-2
6.2	Setting a Scale (Scale)	6-3
6.2.1	Scale	6-3
6.2.2	Offset	6-3
6.2.3	Offset line	6-4
6.2.4	Auto scale	6-4
6.2.5	Setting an electric length	6-4
6.3	Setting the Display Screen (Trace)	6-5
6.3.1	Split display	6-5
6.3.2	Waveform storage	6-5
6.3.3	Waveform overwrite	6-6
6.3.4	Selecting a display grid	6-6
6.3.5	Selecting the items to display or clear	6-7
6.3.6	Subtrace	6-8
6.4	Displaying All Items at the Touch of a Key (Display All)	6-8
6.5	Turning the Backlight ON/OFF (Backlight ON/OFF)	6-9

Section 6 Display (Display Group)

6.1 Active Trace (Active)

Press the  key to select an active trace.

A B

Active

Select a trace whose settings are effective (active trace).

You can use this key only when two traces are displayed for one measurement channel.

Pressing the  key toggles between A (trace A) and B (trace B).

6.2 Setting a Scale (Scale)

Press the  key to make scale-related settings.

Scale	Set the scale of the displayed trace.
-------	---------------------------------------

6.2.1 Scale

Press the  key and select AUTO SCALE or SCALE from the soft key menu to set the screen scale.

Effective key: Ten-key, rotary knob



SCALE	Description of function
AUTO SCALE	Automatically sets a Y-axis scale best suited to the measurement data.
SCALE	Allows you to set a Y-axis scale (display magnification) manually.
OFFSET	
OFS LINE	
EL	
--	

NOTE:

- When two traces are displayed for one measurement channel, a scale and an offset can be set for each trace. The settings made for the active trace are made effective.
- If the analysis format is LOGZ, the width of Y-axis is set in decade units (1, 2, 4, 5, 8, or 10 decades).



6.2.2 Offset

Press the  key and select OFFSET from the soft key menu to set a screen display offset.

Effective key: Ten-key, rotary knob   key

SCALE	Description of function
AUTO SCALE	
SCALE	
OFFSET	Allows you to set a Y-axis offset (display bias) manually.
OFS LINE	
EL	
--	

NOTE:

- When two traces are displayed for one measurement channel, a scale and an offset can be set for each trace. The settings made for the active trace are made effective.
- If the analysis format is LOGZ, a scale can be set from 1 mΩ to 100 M Ω in one to ten steps.
- An offset can be set by  or  key (except LOGZ). It can be changed one tenth step of Y-axis width by each press of the key.
- If the analysis format is POLAR, IMPD CHART, or ADMT CHART, an offset cannot be set.

Section 6 Display (Display Group)

6.2.3 Offset line

Press the  key and select OFS LINE from the soft key menu to set a reference line for screen display offset.
Effective key: Ten-key, rotary knob

SCALE	Description of function
AUTO SCALE SCALE OFFSET OFS LINE EL --	Allows you to set a reference line for offset.

NOTE:

A reference line is fixed at the bottom line if analysis format is LOGZ.

6.2.4 Auto scale

Press the  key and select AUTO SCALE from the soft key menu to set a scale and offset automatically.

SCALE	Description of function
AUTO SCALE SCALE OFFSET OFS LINE EL --	Allows you to set a Y-axis scale best suited to the measurement data.

NOTE:

The auto scale is disabled if the analysis format is LOGZ.

6.2.5 Setting an electric length

Press the  key and select EL from the soft key menu to set an electric length.
Effective key: Ten-key, rotary knob

SCALE	Description of function
AUTO SCALE SCALE OFFSET OFS LINE EL --	Allows you to set a calibration value used to calibrate electric lengths.

6.3 Setting the Display Screen (Trace)

Press the  key to make the setting related to the display screen.

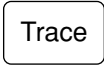
	Set a trace display type and scale grid display type, select display items, and make subtrace-related settings.
---	---

6.3.1 Split display

Press the  key and select SPLIT DISP from the soft key menu to display split views.

TRACE (1/2)	Description of function
SPLIT DISP STORAGE OVER WRITE GRID DISPLAY ITEM etc.	Displays a screen split into upper and lower views. *1 Switches to the next menu.

NOTE:

- *1 • When one trace is displayed for one channel, the display screen cannot be split.
- When the screen display is split is the one channel, two traces mode, trace A is displayed in the upper half and trace B is displayed in the lower half.
- When traces are displayed for two channels, traces of channel 1 are shown in the upper view and traces of channel 2 are shown in the lower view.
- If the screen display is not split when at least three waveform are displayed, this will disable the use of the limit test function.

6.3.2 Waveform storage

Press the  key and select STORAGE from the soft key menu to turn ON/OFF the waveform storage function.

TRACE (1/2)	Description of function
SPLIT DISP STORAGE OVER WRITE GRID DISPLAY ITEM etc.	Allows you to turn ON/OFF the waveform storage function. Switches to the next menu.

Section 6 Display (Display Group)

6.3.3 Waveform overwrite

Press the key and select OVER WRITE from the soft key menu to turn ON/OFF the waveform overwrite function.

TRACE(1/2)	Description of function
SPLIT DISP STORAGE OVER WRITE GRID DISPLAY ITEM etc.	Allows you to turn ON/OFF the waveform overwrite function. Switches to the next menu.

6.3.4 Selecting a display grid

Press the key and select GRID from the soft key menu to select a grid type.

Effective key: Ten-key, rotary knob key

TRACE (1/2)	Description of function
SPLIT DISP STORAGE OVER WRITE GRID DISPLAY ITEM etc.	Displays the window for selecting a grid type. Switches to the next menu.



-GRID- WINDOW

- GRID TYPE: Select a scale grid display type.
- ALL: Displays the frame and all vertical/horizontal lines.
- CENTER: Displays the frame and only vertical/horizontal center lines.
- FRAME: Displays only the frame.

6.3.5 Selecting the items to display or clear

Press the  key and select the items to display or clear using the following soft key menu and window. Select an item to be deleted on the window. The selected item constitutes the deletion target.

TRACE (1/2)	Description of function
SPLIT DISP STORAGE OVER WRITE GRID DISPLAY ITEM etc.	Displays the window to select the displayed item. Switches to the next menu.

Effective key: Ten-key, rotary knob   key

-DISPLAY ITEM- WINDOW

SELECT ITEM:

- 01.<SETUP-A> A line to display the marker value, scale value and other data of Trace A.
- 02.<SETUP-B> A line to display the marker value, scale value and other data of Trace B.
- 03.<MEAS PRMS> Selection to display the measuring conditions such as the analysis for mat and RBW (common to Trace A and B).
- 04.<FREQUENCY> A line (lines) to display the range of the frequencies measured.
- 05.<MENU> Soft key menu
- 06.<SWEEP MKR> Sweep marker (common to Trace A and B).
- 07.<CHART-A> Grid to display Trace A.
- 08.<CHART-B> Grid to display Trace B.
- 09.<TRACE-A> Measured waveform of Trace A.
- 10.<TRACE-B> Measured waveform of Trace B.
- 11.<MARKER-A> Marker of Trace A.
- 12.<MARKER-B> Marker of Trace B.
- 13.<TOP LINE> The single uppermost line to display the active channel, date and other information.

NOTE:

- Executing setting for individual channels is disabled. Channels 1 and 2 are always coupled when displayed or deleted.
- The “Display All” key enables switching between “Display of All Items” and “Display of Only Items Selected by This Setting”.

Section 6 Display (Display Group)

6.3.6 Subtrace

Press the  key and make subtrace-related settings using the following soft key menu.

TRACE (2/2)	Description of function
SUB TRACE	Turns ON/OFF the subtrace function.
MT→ST	Copies all data from the main trace to the subtrace.
MT = ST	Copies data from the main trace to the subtrace for each measurement point.
MT = MT-ST	Subtracts the subtrace data from the measurement data for each measurement point and stores the result as main trace data.
--	
etc	Returns to the previous menu.

NOTE:

- The active trace is the main trace and the inactive trace is the subtrace.
- When ANALYSIS FORMAT requiring two traces per channel is selected, the subtrace function cannot be performed.
- When PHASE is selected as an analysis format, the result value is converted to a value which is between -180° and $+180^\circ$.
- When $MT=MT-ST$ is selected after selecting $MT \rightarrow ST$ or $MT=ST$ with the smoothing function ON, smoothing is performed for the result of $MT-ST$.
- If a subtrace waveform is recalled from a floppy disk, internal memory, or PMC, the $MT-ST$ function cannot be performed again using the recalled data.

6.4 Displaying All Items at the Touch of a Key (Display All)

Display all key

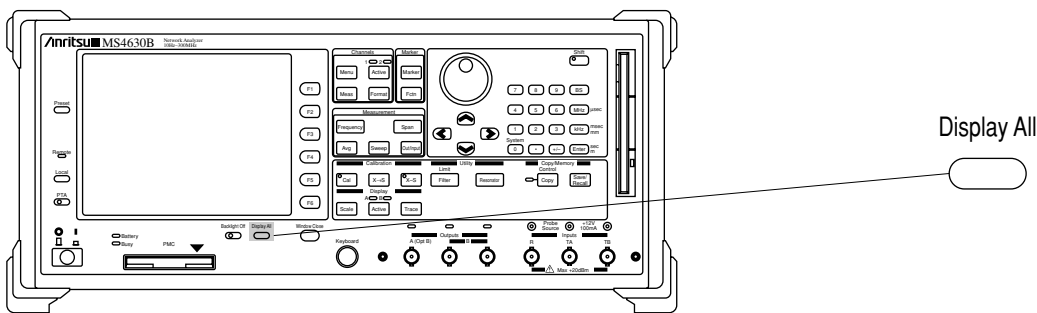

Front panel

Major function

- Clearing selected items

NOTE:

The items selected in the DISPLAY window brought up from the TRACE menu will be cleared.

6.5 Turning the Backlight ON/OFF (Backlight ON/OFF)

6.5 Turning the Backlight ON/OFF (Backlight ON/OFF)

Backlight Off key

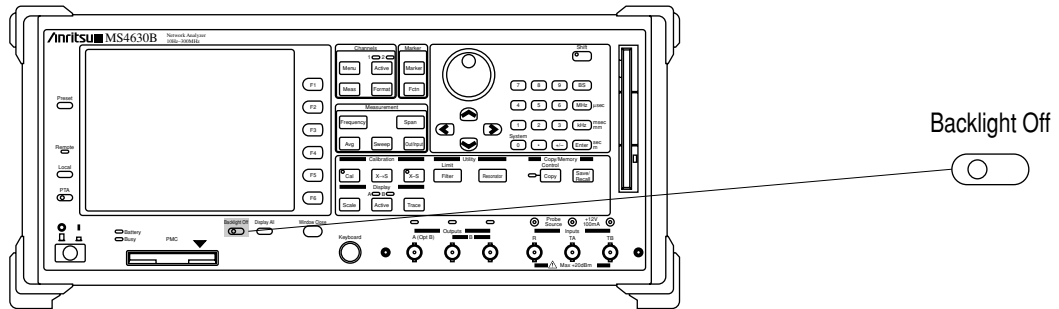

Front panel

Major function

- Pressing the  key toggles the backlight ON and OFF.

Section 6 Display (Display Group)

Section 7 Marker (Marker Group)

This section explains how to use markers when reading measured values from measurement waveforms.

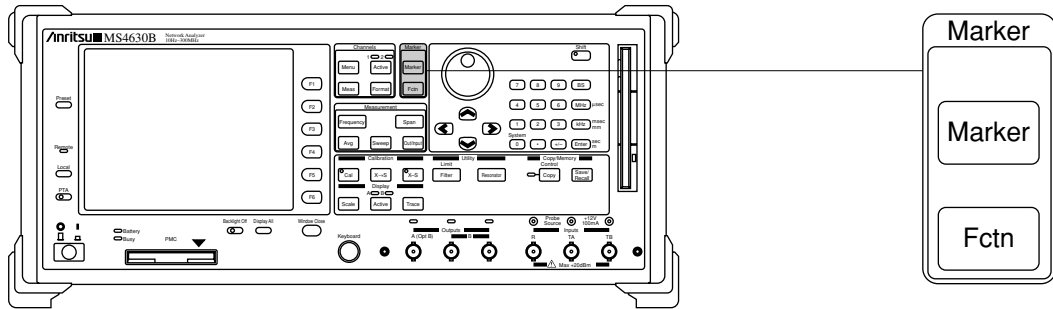

Front panel

Major functions

- Setting/moving markers
- Setting multimarker/marker list
- Setting various marker modes
- Performing MKR→*** functions

7.1	Setting, Moving, and Displaying Markers (Marker)	7-2
7.1.1	Setting and moving markers	7-2
7.1.2	Displaying a special marker (delta marker, zero marker, or marker list)	7-4
7.2	Useful Marker Functions (Fctn)	7-5
7.2.1	Moving a marker (MAX, MIN, ±PEAK, tracking)	7-5
7.2.2	Setting measurement conditions using marker positions (MKR → CF, Δ → SPAN, MKR → OFS)	7-5

Section 7 Marker (Marker Group)



7.1 Setting, Moving, and Displaying Markers (Marker)

7.1.1 Setting and moving markers

Press the  key and set and move markers using the soft key menus below.



Marker	Set/move a marker and set a display mode.
--------	---

(1) Moving the active marker and setting a new marker.

- Press the Marker key to enable move of the active marker.
Effective key: Ten-key, rotary knob   key
- Every time the ON key of the soft key menu is pressed, a new marker is generated (up to 10 new markers). The active marker will shift to the newly generated marker.

MARKER (1/2)	Description of function
ON	Enables move of the active marker or setting of a new marker, and move of the marker.
SCROLL	
OFF	
REF MKR No	
COUPLED	
MARKER	Switches to the next menu.
etc.	

NOTE:

Allows you to move the marker by   key. The marker is moved one tenth of the Y-axis width by each press of the key.

(2) Switching the active marker.

Every time the SCROLL key of the soft key menu is pressed, the active markers among preset markers are selected in sequence.

MARKER (1/2)	Description of function
ON	Selects the active markers in sequence.
SCROLL	
OFF	
REF MKR No	
COUPLED	
MARKER	Switches to the next menu.
etc.	

7.1 Setting, Moving, and Displaying Markers (Marker)

- (3) Deleting the marker.

Delete a marker selected as the active marker.

MARKER (1/2)	Description of function
ON SCROLL OFF REF MKR No COUPLED MARKER etc.	Deletes a marker selected as the active marker. Switches to the next menu.

- (4) Setting the reference marker.

Set the reference marker using the marker No.

Effective key: Ten-key, rotary knob

MARKER (1/2)	Description of function
ON SCROLL OFF REF MKR No COUPLED MARKER etc.	Sets the reference marker using the marker No. (0 to 9). Switches to the next menu.

- (5) Coupling the marker.

Execute setting of whether to interlink the marker positions between Trace A and B.

MARKER (1/2)	Description of function
ON SCROLL OFF REF MKR No COUPLED MARKER etc.	Executes setting of whether to interlink the marker positions between Trace A and B. (ON/OFF) Switches to the next menu.

- (6) Replacing the active and reference markers.

MARKER (1/2)	Description of function
ON SCROLL OFF REF MKR No COUPLED MARKER etc.	Replaces the active and reference markers. Switches to the next menu.

Section 7 Marker (Marker Group)

7.1.2 Displaying a special marker (delta marker, zero marker, or marker list)

Press the Marker key and switch the indicated value of the marker using the soft key menus below.

MARKER (2/2)	Description of function
NORMAL	Select a normal marker.
ΔMKR	Selects a delta marker.
0MKR	Selects a zero marker.
MKRCHANGE	Replaces the active and reference markers.
MKRLIST	Displays a maker list (when set ON.)
etc.	Returns to the previous menu.

- (1) NORMAL MARKER mode: Displays the active marker value as it is.
- (2) DELTA MARKER mode: Obtains the difference between the active marker and reference marker.
- (3) ZERO MARKER mode: Stores the active marker value detected at depression of the “ZERO MARKER” key, then obtains the difference between the active marker value and the stored values.
- (4) MKRLIST: Displays a maximum of 10 markers set for the active channel. These ten markers are automatically selected following the rule below.

Priority	Marker
1	Active marker on active trace
2	Active marker on inactive trace
3	Inactive marker (lower marker number) on active trace
4	Inactive marker (lower marker number) on inactive trace
5	Inactive marker (higher marker number) on active trace
6	Inactive marker (higher marker number) on inactive trace

NOTE:

When the MKRLIST display is selected, traces only for the active channel can be displayed. The results of Δ MKR and 0 MKR cannot be displayed as the MKRLIST. All of these are displayed in the NORMAL MARKER mode.

7.2 Useful Marker Functions (Fctn)

Press the  key and perform various marker functions using the soft key menus below.

7.2.1 Moving a marker (MAX, MIN, \pm PEAK, tracking)

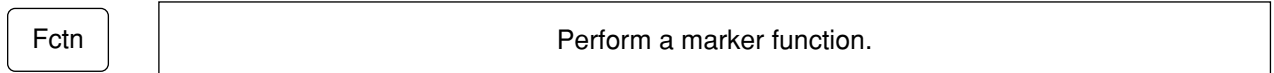

FUNCTION (1/2)	Description of function
MKR→MAX	Moves the marker to the maximum value on the waveform.
MKR→MIN	Moves the marker to the minimum value on the waveform.
MKR→CF	
Δ →SPAN	
MKR→OFS	
etc.	Switches to the next menu.

FUNCTION (2/2)	Description of function
MKR→+PEAK	Moves the marker to the highest peak on the waveform.
MKR→-PEAK	Moves the marker to the lowest peak on the waveform.
TRK+PEAK	Moves the marker to the highest peak of the waveform after each sweep (Tracking.)
TRK-PEAK	Moves the marker to the lowest peak of the waveform after each sweep (Tracking.)
TRK OFF	Turns OFF the tracking function.
etc.	Returns to the previous menu.

7.2.2 Setting measurement conditions using marker positions (MKR → CF, Δ → SPAN, MKR → OFS)

FUNCTION (1/2)	Description of function
MKR→MAX	
MKR→MIN	
MKR→CF	Sets the marker frequency to the center frequency.
Δ →SPAN	Sets the delta marker value (difference in frequency) to the frequency span.
MKR→OFS	Sets the offset so that the marker moves to the offset line.
etc.	Switches to the next menu.

Section 7 Marker (Marker Group)

Section 8 Calibration (Calibration Group)

This section explains the calibration which is necessary to eliminate errors in the values measured by the measuring system.

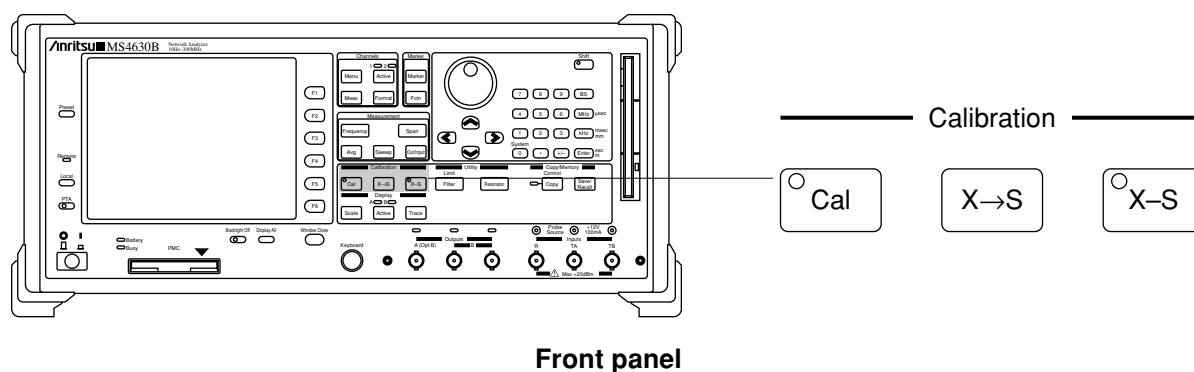

Major functions

- Selecting a calibration method
- Fetching measurement data into the system
- Calculation of error data
- Normalization (X-S)

8.1	Explanation	8-2
8.2	Normalization (X-S)	8-3
	8.2.1 Fetching reference data	8-3
	8.2.2 Turning the normalization function ON/OFF	8-3
8.3	Vector Errors Calibration (Cal)	8-4
	8.3.1 Preparation for calibration	8-4
	8.3.2 Calibration procedure	8-5
8.4	Interpolating Calibration Data	8-9

Section 8 Calibration (Calibration Group)

8.1 Explanation

This system supports the following two methods of correcting errors in the values measured by the measuring system:

- Normalization

- Vector error calibration

These methods have both advantages and disadvantages, so you must select either method according to your purpose. Let's take a look at the differences between these two methods.

Features of normalization

The normalize calibration method finds the difference between the waveform data displayed on the screen and the reference data obtained in advance. This operation is performed on the waveform displayed on the screen after it is processed to the analysis format (e.g., amplitude and phase), and not on the measured signals (vector with magnitude and phase angle).

Features of vector error calibration method

A device with known characteristics is measured by a measuring system, the measured value is compared with the logical value to obtain the error in the value measured by the measuring system, then this error is corrected. This calculation is performed for the measured signal (vector quantity) which has not been converted to a waveform. This method is further classified into some methods depending on the type of the error to be corrected.

The greatest difference is that the calculation is performed before or after conversion of measurement data to a display waveform. The vector error calibration method does not require recalibration if the waveform display mode is changed (e.g., from MAG to MAG/PHASE). On the other hand, the normalization method requires recalibration. Generally, the vector error calibration is more complicated and requires more time and effort than the normalization method.

8.2 Normalization (X-S)

8.2.1 Fetching reference data

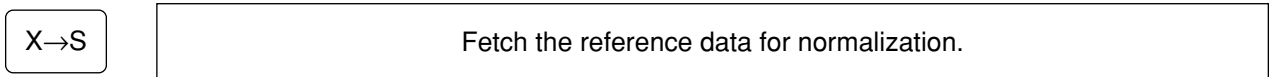

- The normalization method displays the difference between the reference data stored in the system and the data obtained by actually carrying out a sweep measurement.
- The difference is obtained for the scalar data obtained after processing data into the selected analysis format (MAG, PHASE, DELAY, etc.). The reference data is also stored as scalar data.

NOTE:

- When PHASE is selected as an analysis format (PHASE, θ), the result value is converted to a value which is between -180° and $+180^\circ$.
- This function can be used for simple calibration of frequency responses.
- Pressing this key starts the uptake sweep of reference data and, after the sweep is completed, turns the normalize calibration ON. In the following sweep and thereafter, the calibrated measurement waveform is displayed.

8.2.2 Turning the normalization function ON/OFF

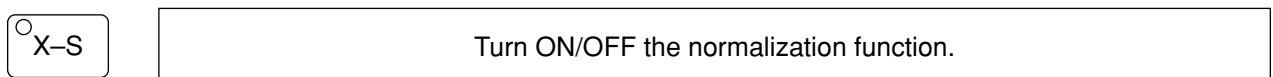

NOTE:

Turning the normalization function ON, "S" is displayed on the left side of the display as showing this condition. Turning the normalize function OFF does not delete the reference data taken into the device. Changing the measurement conditions or recalling a file from a floppy disk, internal memory, or PMC turns the normalize function OFF. The normalize function is performed independently for each measurement channel. Therefore, to use the normalize function for both of the measurement channels, the reference data must be read for each of the channels.

Section 8 Calibration (Calibration Group)

8.3 Vector Errors Calibration (Cal)

Press the  key and set and carry out vector error calibration.

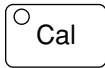

Select a calibration method, fetch calibration data, and make error calculations.

8.3.1 Preparation for calibration

- The soft key menu to be displayed depends on the calibration method used.
- To set a calibration method, press the  (Setup) key to display a window and select “CAL METHOD” from the displayed window.

-SETUP- WINDOW

- CAL METHOD: Display the window for selecting a calibration method and setting a THROUGH LINE characteristic.
- CONNECTOR PARAMETER: Display the window for setting OPEN STD and SHORT STD characteristics.

-CAL METHOD- WINDOW

- CAL METHOD: Select a calibration method.
- THROUGH LINE: Set the offset length of the through line to be used.

-CONNECTOR PARAMETER- WINDOW

- OPEN: Set the characteristic of the open device to be used.
- SHORT: Set the characteristic of the short device to be used.

8.3.2 Calibration procedure

- (1) Set up the measuring system using various calibration tools (THROUGH LINE, OPEN STD, SHORT STD, LOAD STD, etc.)
- (2) Start fetching the calibration data.
Calibration data states are indicated by the following messages in menus.
 “Default”: Calibration data has not been fetched into the system completely.
 “Measuring”: Calibration data is being fetched.
 “Created”: Calibration data has been fetched.
- (3) Error calculations are performed using the calibration data fetched into the system by pressing the F6 key (CAL ON key).
- (4) When error calculations are complete, the CAL lamp lights up (CAL ON state) and the calibrated measurement result is obtained after each of the succeeding sweeps.

NOTE:

- Pressing the Cal key with CAL ON selected extinguishes the CAL lamp and produces the CAL OFF state.
- The CAL OFF state is also produced when recalibration is required due to a change in measurement condition.
- Select CAL ON/OFF for each channel irrespective of the coupled channel state.

<RESPONSE calibration>

RESPONSE	Description of function
RESPONSE	Starts fetching THROUGH LINE calibration data.
--	
--	
--	
SETUP	Displays the window for selecting a calibration method and setting conditions.
CAL ON	Starts calculating error calibration data and turns ON the calibration/measurement function.

NOTE:

Since this calibration is related to transfer measurement, only the frequency response data is vector-calibrated using the through line.

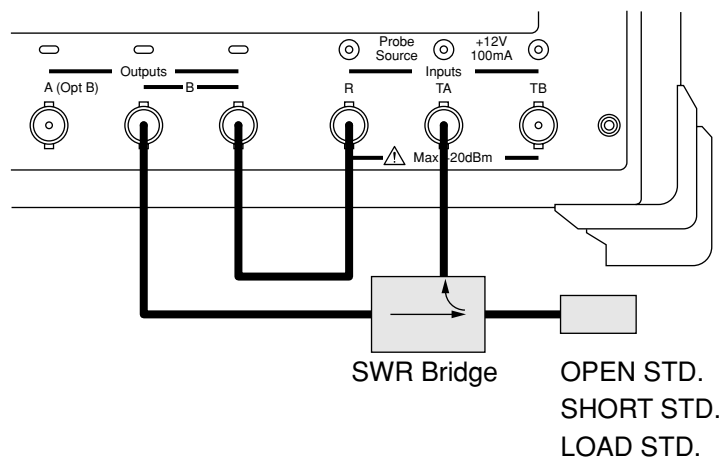

Example of setup for RESPONSE calibration

Section 8 Calibration (Calibration Group)

<1PORT OSL calibration>

1PORT OSL	Description of function
OPEN	Starts fetching OPEN STD calibration data.
SHORT	Starts fetching SHORT STD calibration data.
LOAD	Starts fetching LOAD STD calibration data.
SETUP	Displays the window for selecting a calibration method and setting conditions.
CAL ON	Starts calculating error calibration data and turns ON the calibration/measurement function.

NOTE:

Since this calibration is related to reflection measurement, vector calibration is performed using OPEN, SHORT, or LOAD calibration data.

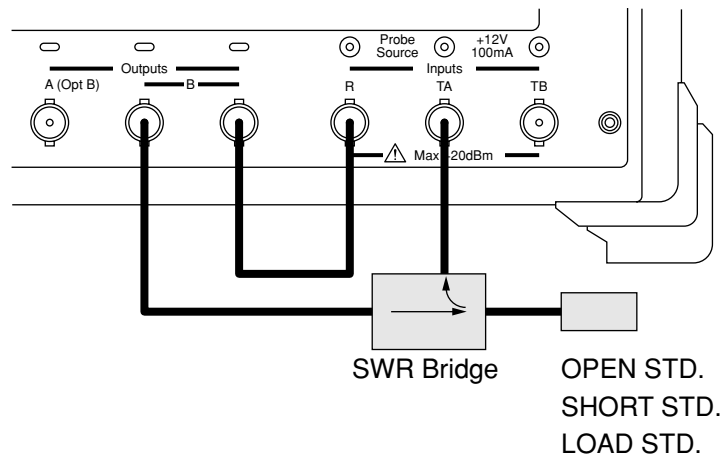

Example of setup for 1PORT OSL calibration

<1PATH 2PORT calibration>

1PATH 2PORT	Description of function
OPEN	Starts fetching OPEN STD calibration data.
SHORT	Starts fetching SHORT STD calibration data.
LOAD	Starts fetching LOAD STD calibration data.
THRU	Starts fetching THROUGH LINE calibration data.
SETUP	Displays the window for selecting a calibration method and setting conditions.
CAL ON	Starts calculating error calibration data and turns ON the calibration/measurement function.

NOTE:

Since this calibration is related to transfer/reflection measurement, only forward characteristics (excluding the load matching error) are vector-calibrated for 12TERM.

8.3 Vector Errors Calibration (Cal)

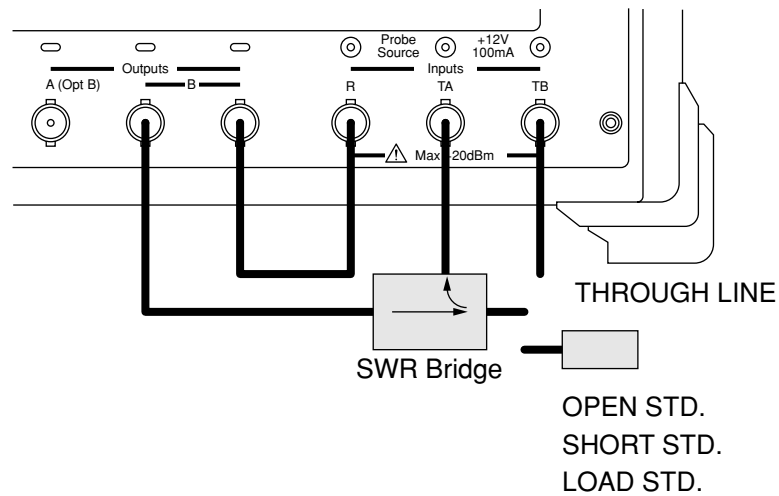

Example of setup for 1PATH 2PORT calibration

Precautions for 1PATH 2PORT calibration

- Since this calibration is performed using the calibration data on two channels, an input port TB (optional unit) is required.
- Select CH1 & CH2 (dual channel measurement) as measurement channels and set on “COUPLED CHANNEL.”
- Use measurement CH1 for reflection measurement. Select TA/R as the CH1-side analysis port.
- To obtain (sweep) OPEN, SHORT, or LOAD calibration data, select CH1 as the active channel. When obtaining LOAD calibration data, obtain the transmission-side (CH2) LOAD data at the same time.
- Use measurement CH2 for transfer measurement. Select TB/R as the CH2-side analysis port. To obtain THROUGH calibration data, select CH2 as the active channel. When obtaining THROUGH calibration data, obtain the reflection-side (CH2) THROUGH calibration data at the same time.
- Select CAL ON (sweep start) for individual channels.
- When calibrate CH2, select CAL ON both CH1 and CH2, otherwise proper calibration will not be executed.

Section 8 Calibration (Calibration Group)

<PI NET calibration>

PI-NET	Description of function
OPEN	Starts fetching transfer OPEN (open) calibration data.
SHORT	Starts fetching transfer SHORT (through) calibration data.
--	
--	
SETUP	Displays the window for selecting a calibration method and setting conditions.
CAL ON	Starts calculating error calibration data and turns ON the calibration/measurement function.

NOTE:

- This calibration method is used to measure the resonator impedance in the TRANSFER mode using a pi network jig.
- To measure the resonator impedance using a pi network jig, set “IMPD MEASUREMENT” to “TRANSFER” in “F1:USER PRESER” in the system menu (displayed by pressing SHIFT + 0 (SYSTEM)). In addition, press the key, select “F6:etc.” to display “F5:REFIMPD”, and set the reference impedance to the impedance of the pi network jig.

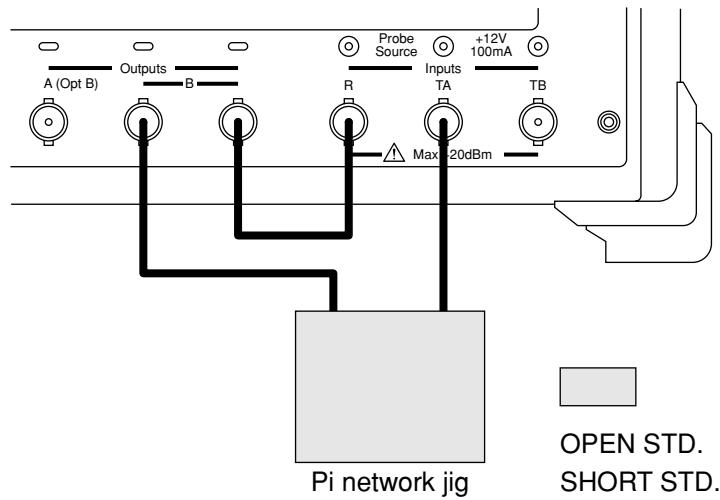

Example of setup for PI NET calibration

<RESPONSE & ISOLATION calibration>

RESP&ISLN	Description of function
RESPONSE	Starts fetching THROUGH LINE calibration data.
ISOLATION	Starts fetching ISOLATION (cross talk) calibration data.
--	
--	
SETUP	Displays the window for selecting a calibration method and setting conditions.
CAL ON	Starts calculating error calibration data and turns ON the calibration/measurement function.

NOTE:

Since this calibration is related to transfer measurement, frequency response data and isolation (cross talk) data are vector-calibrated using THROUGH LINE and LOAD STD.

8.4 Interpolating Calibration Data

If the measurement frequency range and measurement point are changed after completion of vector error calibration, it is common practice to create new calibration data to obtain a correct calibration result. With this system, however, press from the soft key menu after setting a new frequency and point compares the old one with the new one to create calibration data for the new frequency and point, allowing you to obtain a calibration result which is close to the calibration result obtained using new calibration data.

NOTE:

If a new frequency is not included in the old frequency range, the result of calibration for the new frequency may become incorrect.

Or, “ I ” is indicated on the left side of the display, because the data is not interpolated by the latest calibration.

Section 8 Calibration (Calibration Group)

Section 9 Analysis of Measurement Data (Utility Group)

This section explains three analysis functions supported by this system: filter analysis, resonator analysis, and limit test.

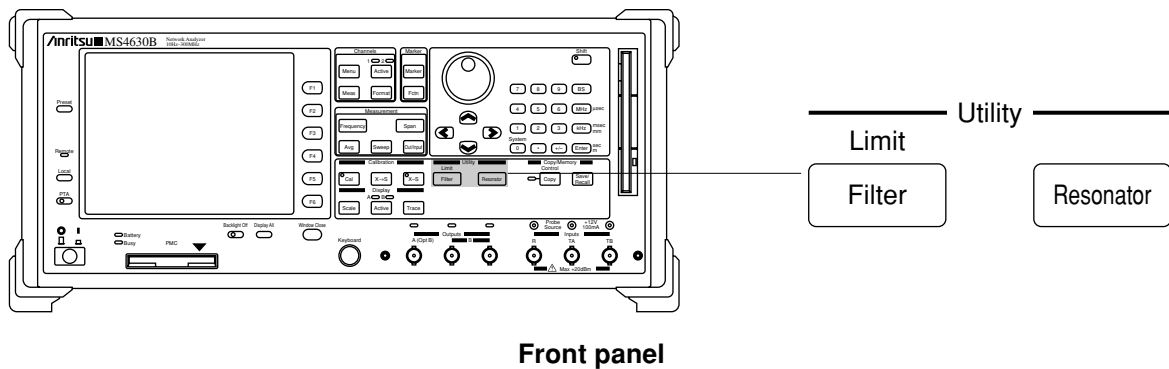

Major functions

- Filter analysis function
- Resonator analysis function
- Limit Test (Judging trace data according to standard line)

9.1	Filter Analysis Function (Filter)	9-2
9.2	Resonator Analysis Function (Resonator)	9-5
9.3	Limit Test (Limit)	9-8

Section 9 Analysis of Measurement Data (Utility Group)

9.1 Filter Analysis Function (Filter)

Press the  key and set and perform the filter analysis function using the displayed soft key menu and window.

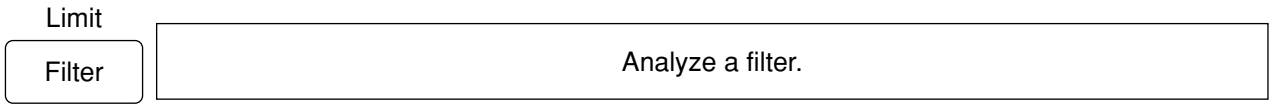

FILTER	Description of function
ANALYSIS	Allows you to turn ON/OFF the filter analysis function.
SETUP	Displays the window for setting analysis conditions.
--	
--	
--	
--	

NOTE:

- A filter analysis is performed for each sweep and the analysis result is displayed.
- If an analysis result cannot be obtained, 0 is displayed.
- This function cannot be performed when the frequency setting mode is LOG.
- The following parameters are analyzed:
 - BW1: X1 dB down bandwidth
 - BW2: X2 dB down bandwidth
 - ΔFL1: Low bandwidth at X1 dB down point
($\Delta FL1 = (\text{Nominal center frequency}) - (\text{Low frequency of X1 dB down point})$)
 - ΔFR1: High bandwidth at X1 dB down point
($\Delta FR1 = (\text{Nominal center frequency}) - (\text{Low frequency of X1 dB down point})$)
 - ΔFL2: Low bandwidth at X2 dB down point
($\Delta FL2 = (\text{Nominal center frequency}) - (\text{Low frequency of X2 dB down point})$)
 - ΔFR2: High bandwidth at X2 dB down point
($\Delta FR2 = (\text{Nominal center frequency}) - (\text{Low frequency of X2 dB down point})$)
 - IL: Insertion loss
 - F0: Filter center frequency ($F0 = (FL1 + FR1)/2$)
 - Q: Q value ($Q = \frac{\sqrt{FL1 \times FR1}}{BW1}$)
 - SF: Shape factor ($SF = BW2/BW1$)
 - RPL: Ripple

9.1 Filter Analysis Function (Filter)

Effective key: Ten-key, rotary knob

-SETUP- WINDOW

FILTER CF: Set the nominal center frequency of the filter to analyze.

NOTE:

When 0 Hz is set or the set frequency is not included in the measurement band, an analysis is carried out assuming that the current center frequency is the nominal center frequency.

REF FOR IL CALC: Set the reference point used to obtain the insertion loss.

FILTER CF: Nominal center frequency

MAX VALUE: Maximum value in band

BW REF: Set the reference point used to obtain an X* dB down bandwidth.

FILTER CF: Nominal center frequency

MAX VALUE: Maximum value in band

X1 dB DOWN: Set an X1 dB value.

X2 dB DOWN: Set an X2 dB value.

RPL SEARCH START: Set a ripple detection start frequency.

RPL SEARCH EN: Set a ripple detection end frequency.

RPL RESOLUTION: Set the minimum difference in level between the positive peak and the negative peak that allows a ripple to be detected.

Waveform fluctuations smaller than the specified level are not regarded as a ripple.

FREQ DISP DIGITS: Set a number of digits to be used to display an analysis result (frequency).

Section 9 Analysis of Measurement Data (Utility Group)

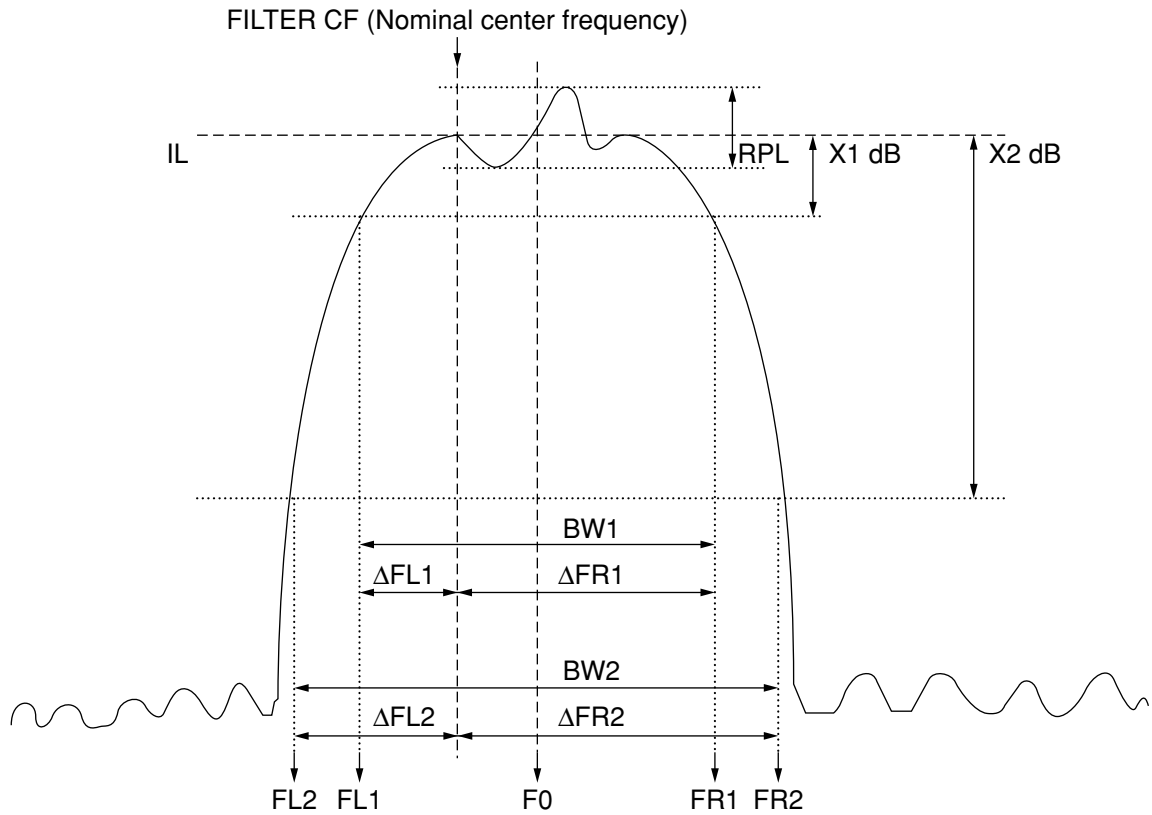

REF FOR INSERTION LOSS = FILTER CF

REF FOR XdB DOWN BW = Analysis parameter for FILTER CF

Example of analysis result

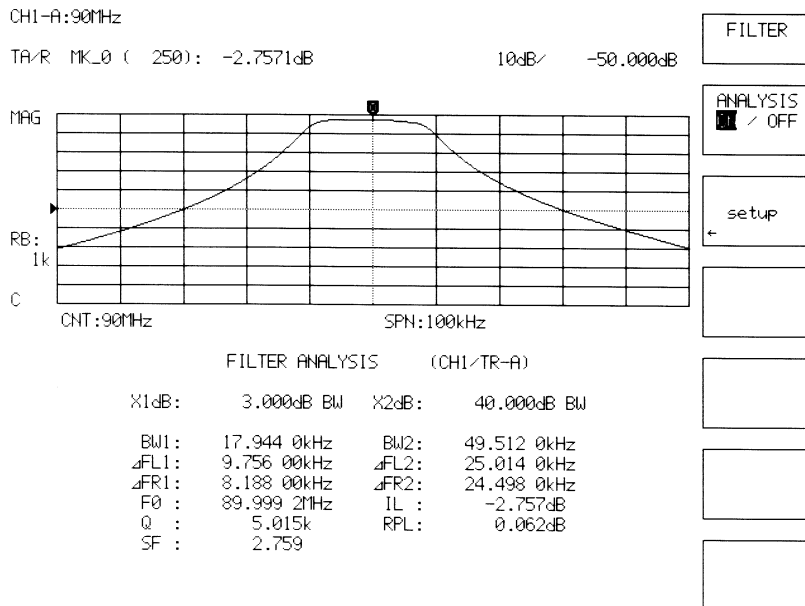

Filter analysis result

9.2 Resonator Analysis Function (Resonator)

Press the Resonator key and set and perform the resonator analysis function using the displayed soft key menu and window.

Resonator	Analyze a resonator.
---	----------------------

RESONATOR	Description of function
ANALYSIS setup	Allows you to turn ON/OFF the resonator analysis function. Displays the window for setting analysis conditions.
RESON 1	Selects a simple evaluation mode.
RESON 2	Selects a total evaluation mode (analysis of equivalent constants of crystal resonator.)
--	
--	

NOTE:

- A resonator analysis is performed for each sweep and the analysis result is displayed.
- If an analysis result cannot be obtained, 0 is returned.
- This function can be performed only under the following conditions:

“RESON1”:

ZERO PHASE analysis method: LOG Z & θ
(Z and both θ = Trace-A and θ = Trace-B are used.)

MIN/MAX IMPD analysis method: LOG Z or LOG Z & θ
(The active trace is analyzed.)

“RESON2”:

LOG Z and θ (Z and both θ = Trace-A and θ = Trace-B are used.)

This function can be performed when “IMPD MEASUREMENT” is set to “TRANSFER.”

If X-S, SUB TRACE, and SMOOTHING are performed, values of R1, C0, C1, L1, and Q are analyzed assuming these processes are not performed.

- This function can not be performed when the frequency setting mode is LOG.
- The following analysis result is displayed:

“RESON1”

-ZERO PHASE analysis method-

Fr: Low frequency when impedance phase is 0
Zr: Impedance at Fr
Fa: High frequency when impedance phase is 0
Za: Impedance at Fa

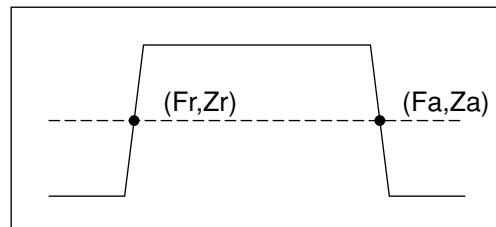

-MIN/MAX IMPD analysis method-

Fn: Frequency at maximum impedance
Zn: Impedance at Fn
Fm: Frequency at minimum impedance
Zm: Impedance at Fm

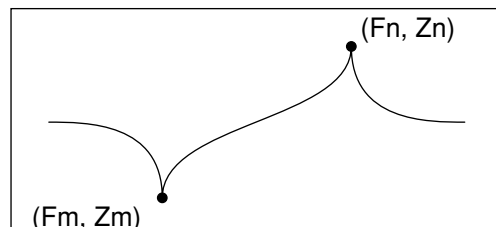

Section 9 Analysis of Measurement Data (Utility Group)

“RESON2”: A 4-element equivalent circuit is analyzed.

Fr, Zr, Fa, Za
 Fs: Series resonance frequency (frequency at maximum conductance G)
 R1: Series resistance
 C0: Parallel capacitance ($C0=C1 \times Fr^2 / (Fa^2 - Fr^2)$)
 C1: Series capacity ($C1=1 / (2\pi Fs \times Q \times R1)$)
 L1: Series inductance ($L1=Q \times R1 / (2\pi Fs)$)
 Q: Quality coefficient ($Q=Fs / (F2 - F1)$)
 F1 and F2 are low and high frequencies at (maximum conductance)/2.

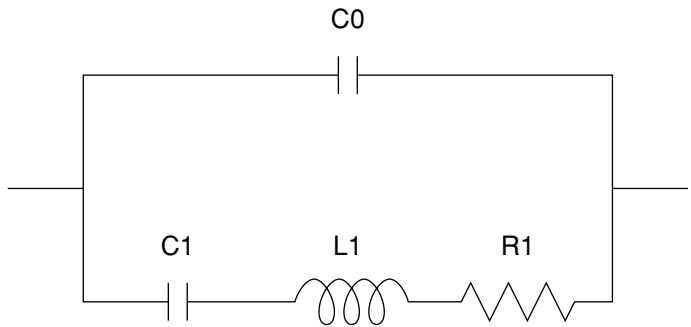

Four-element equivalent circuit

Effective key: Ten-key, rotary knob

-SETUP- WINDOW

- START FREQ:** Sets the start frequency of the band subject to analysis.
- END FREQ:** Sets the end frequency of the band subject to analysis.

NOTE:

If the band subject to analysis is not included in the current measurement band, an analysis is carried out assuming that the current measurement band is the band subject to analysis.

- EVALUATION METHOD FOR RESON1:** Select an analysis method used when “RESON1” is selected.
 - ZERO PHASE:** Obtains the frequency at which the impedance phase becomes 0 and the impedance.
 - MIN/MAX IMPD:** Obtains the frequencies at which the impedance becomes maximum and minimum and the impedances.
- FREQ DISP DIGITS** Set a number of digits to be used to display an analysis result (frequency).



9.2 Resonator Analysis Function (Resonator)

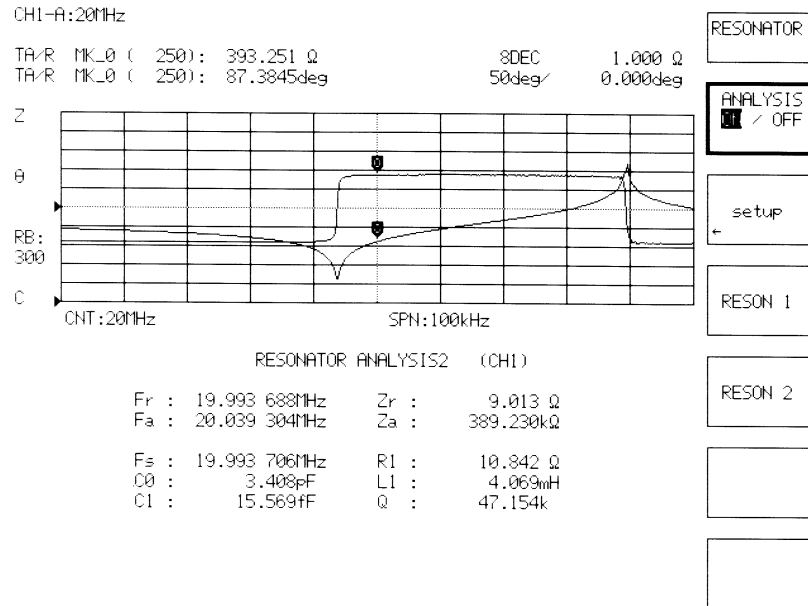

Example of analysis result (RESON2)



Section 9 Analysis of Measurement Data (Utility Group)

9.3 Limit Test (Limit)

Press  +  keys and set and perform the limit test function using the displayed soft key menu and window.

Shift

 +
 Limit
 Filter

Test the trace data according to the standard line.

LIMIT	Description of function
LINE ENTRY	Displays the window for entering a standard line.
TEST	Tests the trace data according to the standard line.
BEEP	Makes the setting for issuing a beep when the test result is "FAIL."
--	
--	
--	

NOTE:

- When the standard line (or part of it) is outside the set frequency range, trace data cannot be tested properly.
- Trace data is tested according to the standard line after each sweep.
- The entered standard line data is calculated as the standard data corresponding to all sweep points under the measurement conditions set when the TEST function was turned ON and the calculation result is stored in the system.
- When the standard line cannot be compared with the measurement waveform due to a change in measurement condition, this function is turned OFF.
 Turning ON the test function again calculates the standard data again under the new conditions.
 If the standard line is outside the set frequency range, trace data cannot be tested properly.
- If the screen display is not split when at least three waveforms are displayed, this will disable the use of the limit test function.
- If the analysis format is LOGZ, the limit test is disabled.

-LINE ENTRY- WINDOW

- LIMIT TYPE: Set a standard line type.
- SINGLE: Sets data that can be represented only by a y-coordinate. The data is constant for all frequencies.
- SEGMENT: Sets data with a combination of (f0, y0) and (f1, y1). (Max. 10 segments)

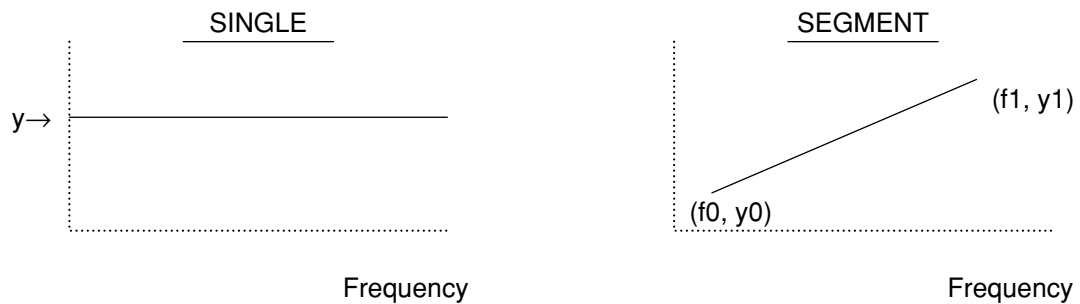

- [UPPER LIMIT ENTRY]: Displays the window for entering the upper limit standard line data.
- [CLEAR]: Displays the window for clearing the upper limit standard line data.
- [LOWER LIMIT ENTRY]: Displays the window for entering the lower limit standard line data.
- [CLEAR]: Displays the window for clearing the lower limit standard line data.

-UPPER (LOWER) LIMIT DEFINE- WINDOW (SINGLE)

- UPPER (LOWER) LIMIT-Y: Set the y value of the upper (lower) standard value.

-UPPER (LOWER) LIMIT CLEAR- WINDOW (SINGLE)

- [CLEAR]: Clear the upper (lower) standard value.
When cleared, the maximum value (or the minimum value for LOWER) is used as the standard value.

-UPPER (LOWER) LIMIT ENTRY- WINDOW (SEGMENT)

- SEGMENT: Set the number of the segment to enter.
- START -X: Set the f0 value of the upper (lower) limit standard value.
- Y: Set the y0 value of the upper (lower) limit standard value.
- END -X: Set the f1 value of the upper (lower) limit standard value.
- X: Set the y1 value of the upper (lower) limit standard value.

Section 9 Analysis of Measurement Data (Utility Group)

-UPPER (LOWER) LIMIT CLEAR- WINDOW (SEGMENT)

<input type="checkbox"/> SEGMENT		Set the number of the segment to clear.
<input type="checkbox"/> START	-X:	Set the f0 value of the upper (lower) limit standard value.
<input type="checkbox"/>	-Y:	Set the y0 value of the upper (lower) limit standard value.
<input type="checkbox"/> END	-X:	Set the f1 value of the upper (lower) limit standard value.
<input type="checkbox"/>	-X:	Set the y1 value of the upper (lower) limit standard value.
<input type="checkbox"/> [CLEAR]		Clear the standard value of the specified segment number.

Section 10 Hard Copy and Remote Control (Copy/Memory Group)

This section explains how to output a hard copy and save/recall measurement conditions and result onto/from the floppy disk.

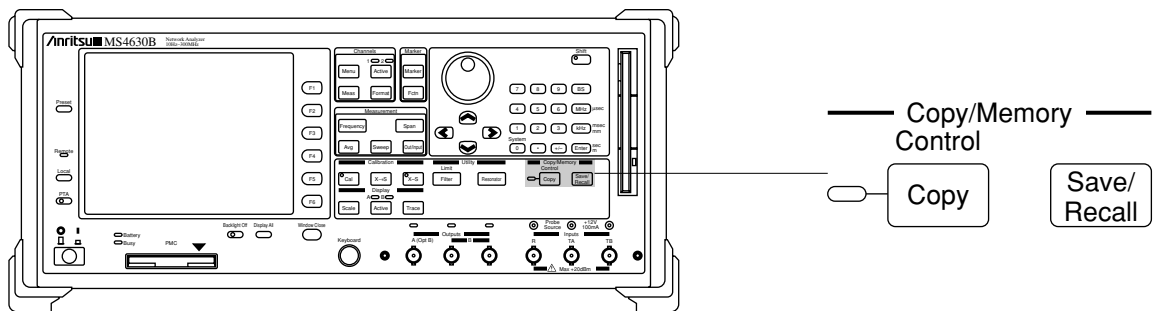

Front panel

Major functions

- Performing and controlling the hard copy function
- Saving/recalling measurement data and conditions
- Entering a title label

10.1	Outputting a Hard Copy of Screen Data (Copy)	10-2
10.2	Making Settings Related to the Hard Copy and Remote Control (Copy, Control, Local)	10-2
10.2.1	Copy Control key	10-2
10.2.2	Local key	10-5
10.3	Save/Recall	10-6

Section 10 Hard Copy and Remote Control (Copy/Memory Group)

10.1 Outputting a Hard Copy of Screen Data (Copy)

Control

Copy

Starts outputting a hard copy to the printer or FD.

- The lamp is lit while hard copy data is being output.
- Pressing this key stops the output of a hard copy.
- Remote printing via the GPIB, RS232C, or Centronics interface or the Separate Video terminal can be controlled. RS232C and centronics interfaces are optional.
- To control copying via the GPIB or RS232C interface, place this system in the “controller” state.
- When an error message is displayed on the screen resulting from the hard copy related operations, see (2) External interface related errors of Appendix D Error Message.

10.2 Making Settings Related to the Hard Copy and Remote Control (Copy Control, Local)

10.2.1 Copy Control key

Shift

○

+
Control

Copy

Set the conditions related to external interfaces and hard copy.

CONTROL	Description of function
GPIB	Displays the window for making GPIB-related settings.
RS232C	Displays the window for making RS232C-related settings.
--	
HARD COPY	Displays the window for making settings related to the hard copy.
BIT MAP	Displays the window for making the settings related to bit-mapped image data.
--	

NOTE:

- This menu is the same as the menu displayed by pressing the  key.
- RS232C-related settings are valid only when the optional unit is installed.
- To output a hard copy, the “CONTROL FUNCTION” of the specified interface must be set to “CONTROLLER” (except when the VIDEO OUT or Centronics interface is used).

10.2 Making Settings Related to the Hard Copy and Remote Control (Copy, Control, Local)

(1) GPIB related setting

Effective key: Ten-key, rotary knob

-GPIB- WINDOW

- | | |
|---|--|
| <input type="checkbox"/> GPIB MY ADDRESS: | Set the GPIB address of this system. |
| <input type="checkbox"/> CONTROL FUNCTION: | Switch between the GPIB DEVICE and CONTROLLER modes of this system. |
| <input type="checkbox"/> ENABLE REGISTER ALL: | Set the GPIB enable register. |
| <input type="checkbox"/> TERMINATER: | Set a terminator code used to output data from this system to the outside. |
| <input type="checkbox"/> TIME OUT: | Set the maximum transmission/reception wait time when this system is in the CONTROLLER mode. Setting 0 second causes the system to wait for transmission/reception for ever. |
| <input type="checkbox"/> ACTIVE PORT: | Set the control interface used to output data (copy output). (This setting cannot be made when an optional unit is not installed.) |

NOTE:

It is impossible to set CONTROL FUNCTION to “DEVICE” for both GPIB and RS232C interfaces.

(2) RS232C related setting

Effective key: Ten-key, rotary knob

-RS232C- WINDOW

- | | |
|--|--|
| <input type="checkbox"/> CONTROL FUNCTION: | Switch between the DEVICE and CONTROLLER modes of this system. |
| <input type="checkbox"/> DEVICE MODE: | Allows you to set measurement conditions and so forth of this system by entering the GPIB command from an external unit. |
| <input type="checkbox"/> CONTROLLER MODE: | Allows you to control an external device (printer). |
| <input type="checkbox"/> TERMINATER: | Set a terminator code used to output data from this system to the outside. |
| <input type="checkbox"/> TIME OUT: | Set the maximum transmission/reception wait time when this system is in the CONTROLLER mode. Setting 0 second causes the system to wait for transmission/reception for ever. |
| <input type="checkbox"/> BAUD RATE: | Set a baud rate. |
| <input type="checkbox"/> DATA BITS: | Set a data length. |
| <input type="checkbox"/> STOP BIT: | Set a stop bit length. |
| <input type="checkbox"/> PARITY: | Make settings related to parity bits. |

Section 10 Hard Copy and Remote Control (Copy/Memory Group)

(3) Hard copy related setting

Effective key: Ten-key, rotary knob

-HARD COPY- WINDOW

- | | |
|--|--|
| <input type="checkbox"/> COPY DEVICE: | Set the hard copy output device or output data format. |
| 1. VIDEO OUT: | Selects the video plotter connected to the Separate Video terminal on the rear panel of the system. |
| 2. ESC/P: | Performs control through the GPIB, RS232C, or Centronics interface and selects an ESC/P printer. |
| 3. HP: | Performs control through the GPIB, RS232C, or Centronics interface and selects a HP printer. |
| 4. FD: | Select the mode in which the screen image data is copied to the FD in the bit-map format. |
| <input type="checkbox"/> GPIB ADDRESS: | Set the GPIB address of the copy destination. |
| <input type="checkbox"/> FORM FEED: | Make settings related to form feed (excluding VIDEO OUT). |
| <input type="checkbox"/> ACTIVE PORT: | Set the control interface used to output data (copy output). (This setting cannot be made when an optional unit is not installed.) |

(4) Settings related to bit-mapped image data

-BIT MAP- WINDOW

- | | |
|---------------------------------------|--|
| <input type="checkbox"/> COLOR TYPE: | Select a bit-mapped data color. |
| 1. MONOCHROME: | Outputs monochrome (black-and-white) data. |
| 2. COLOR: | Outputs 8-bit (256-color) color data. |
| <input type="checkbox"/> COMPRESSION: | Turns on/off data compression. (Effective only for color data) |
| <input type="checkbox"/> COPY No.: | Specify the number of the file to copy to the FD (0000-9999). When copying is completed, the file number is updated automatically. |

- File name extension

Files output to the FD are assigned the following file name extensions:

- .bmp : Data has not been compressed.
- .rle : Data has been compressed.

- File name

The file name format is as follows:

yyddnnnn.bmp (or rle)

yy : Month of file creation (01 to 12)

dd : Day of file creation (01 to 31)

nnnn : Four-digit file number (0000 to 9999)

10.2 Making Settings Related to the Hard Copy and Remote Control (Copy, Control, Local)

- Directory

Files are created under the ¥MS4630¥ directory.

NOTE:

- If a file of the same file name already exists on the FD, it is overwritten.
- The file created on the FD with a file name extension .bmp or .rle cannot be deleted.

10.2.2 Local key

Remote

Local

Cancel the remote state of the GPIB.

Major functions

- Returning to local
- Making settings related to external interfaces

NOTE:

The menus and the associated functions are the same as those of the  key.

Section 10 Hard Copy and Remote Control (Copy/Memory Group)

10.3 Save/Recall

Save/
Recall

Save/recall trace data and measurement conditions in/from an auxiliary storage device.

SAV/RCL (1/2)	Description of function
INDEX RCL	Recalls data according to the title label of a file.
RECALL	Recalls data by entering a file number (00 to 99.)
SAVE	Displays the window for setting the item and file number to save.
MANAGE	Displays the window for managing files.
DRIVE	Displays the window for selecting a storage.
etc.	Switches to the next menu.

SAV/RCL (2/2)	Description of function
TEXT SAVE	Displays the window for saving the measured waveform as character-string data.
TITLE	Displays the window for entering and displaying a title label.
--	
--	
--	
etc.	Returns to the previous menu.

- When an error message is displayed on the screen resulting from operations such as Save and Recall, see (1) Media related errors of Appendix D Error Message.

- (1) Index recall
Recall the index using the title label of the file as the keyword.

-INDEX RECALL- WINDOW

FILE NO & TITLE

Displays the saved file numbers and title labels in a table form.
If there is no file, "UNUSED" is displayed.
When TITLE is set off, "(space)" is displayed.

NOTE:

- Select a desired file using the (◀) or (▶) key, then press the (Enter) key.
- Numbers of files that can be recalled by selecting "INDEX RCL" are 00 to 09.

- (2) Recall
Directly recall the index by entering the file No. (00 to 99).
Effective key: Ten-key
Performing the recall turns the calibration and normalize functions OFF.

(3) Save

-SAVE- WINDOW

- | | |
|---|---|
| <input type="checkbox"/> DATA SIZE: | Display the data size of the item selected to be saved. |
| <input type="checkbox"/> CH1 (CH2) SAVE ITEM: | Select an item to save. |
| PARAM: | Measurement conditions |
| CAL-DATA: | Calibration data |
| X-DATA: | Display trace data (TRACE-A, TRACE-B) |
| S-DATA: | Standard data for normalization (data corresponding to TRACE-A and TRACE-B) |
| FREQ-TB: | Frequency table (frequency data corresponding to measurement points) |
| LEVEL-TB: | Level table corresponding to measurement points used power sweep |
| RBW-TB: | Table storing the RBWs corresponding to each measurement point |
| WAIT-TB: | Table storing the user wait time values corresponding to each measurement point |
| <input type="checkbox"/> SAVE FILE No?: | Specify the number of the file to save. (00 to 99) |
| <input type="checkbox"/> DELETE FILE No?: | Specify the number of the file to delete. (00 to 99) |

(4) Managing the file

-FILE MANAGEMENT- WINDOW

- | | |
|---|--|
| <input type="checkbox"/> FORMAT & MAKE DIR: | Formats the drive and creates the directory. |
| <input type="checkbox"/> MAKE DIR: | Creates the directory for the device on the drive. |
| <input type="checkbox"/> DIR: | Displays the directory. |



NOTE:

- All the data on the drive which constitutes the formatting target will be lost when the drive is formatted.
- Save and Recall will be disabled for the unformatted drive or the drive where no directory for the device has been created.

Section 10 Hard Copy and Remote Control (Copy/Memory Group)

(5) Selecting the drive

Select a drive which will constitute the target of Save, Recall and File Management operations.

Effective key: Ten-key, knob   key

-DRIVE- WINDOW

DRIVE:

1. INT MEN: Internal memory (Note)
2. FD: Floppy disk
3. PMC: Plug in memory card

NOTE:

The drive is not formatted when it is shipped from the factory. Formatting the drive in accordance with the explanations of (4) Managing the file above is required.

(6) Saving the measured waveform data as character-string data

Save the measured waveform (trace) on the FD as character-string data.

This data can be output only to the FD. (It cannot be output to the PMC or internal memory.)

Calibration data, S-memory data, and measurement conditions (parameters) cannot be saved as character-string data.

-TEXT SAVE- WINDOW

- CH1 X-MEM: Select/cancel the CH1-side measured waveform as the item to save as character-string data.
- CH2 X-MEM: Select/cancel the CH2-side measured waveform as the item to save as character-string data.
- SAVE: Specify a file number and save the file on the FD.

- File name

When SAVE is executed, the following files are created for each measurement channel:

CH1-side measured waveform data file: C1XMEM**.CSV

CH2-side measured waveform data file: C2XMEM**.CSV

** stands for a specified file number (00-99).

- Types of data to be saved

In the case of single trace (one measured waveform), one type of array data is saved for each measurement channel. In the case of dual trace (two measured waveforms), two types of array data are saved. Suppose two types of array data are defined as XA(*) and XB(*), then they will be saved according to the table shown below.

Array data elements range from 0 to the number of measure points minus 1.

Measurement format	Array data XA(*)	Array data XB(*)
LOG MAG	LOG MAG measurement data	-----
PHASE	PHASE measurement data	-----
DELAY	DELAY measurement data	-----
MAG & PHASE	LOG MAG measurement data	PHASE measurement data
MAG & DELAY	LOG MAG measurement data	DELAY measurement data
POLAR	X-data of displayed waveform (*1)	Y-data of measured waveform (*2)
IMPEDANCE CHART	X-data of displayed waveform (*1)	Y-data of measured waveform (*2)
ADMITTANCE CHART	X-data of displayed waveform (*1)	Y-data of measured waveform (*2)
VSWR	VSWR measurement data	-----
LINEAR MAG	LIN MAG measurement data	-----
LIN & PHASE	LIN MAG measurement data	PHASE measurement data
LIN & DELAY	LIN MAG measurement data	DELAY measurement data
REAL	REAL measurement data	-----
IMAGINARY	IMAGINARY measurement data	-----
REAL & IMAGINARY	REAL measurement data	IMAGINARY measurement data
LOG Z	Data of displayed waveform (*3)	-----
LOG Z & θ	Data of displayed waveform (*3)	θ measurement data
Q	Q measurement data	-----
LOG Z & Q	Data of displayed waveform (*3)	Q measurement data

NOTE:

When two measured waveforms are displayed using the subtrace function, two types array data (XA(*) and XB(*)) are used.

NOTE:

- *1 Value of the real part of the complex data in the circular chart.
- *2 Value of the imaginary part of the complex data in the circular chart.
- *3 The relationship between the displayed waveform data (XA(*)) and impedance (Z) is as follows.

$$Z (\Omega) = 10^{(XA(*)/10)} / 1000$$

Section 10 Hard Copy and Remote Control (Copy/Memory Group)

- Number of array data items to be saved

Measurement data items between the first measure point and the (number of measure point - 1)th measure point are saved.

- Format of data to be saved

One type of array data (XA(*))	Two types of array data (XA(*) and XB(*))
XA(0)LF XA(1)LF • X(MEP-1)LF	XB(0)LF XB(0)LF • X(MEP-1), XB(MEP-1)LF

LF represents a terminal code and MEP represents a number of measure points.

When there are two types of array data, array data items are separated by a comma (,).

----- Example of output in character data format -----

- Number of measure points: 11

Measurement format: LOG MAG (In the case of single trace, only LOG MAG measurement data is output as array data XA(*).)

Each LOG MAG measurement data
- 68.1109LF
- 60.8254LF
- 50.9415LF
- 36.1592LF
- 9.5055LF
- 0.9984LF
- 15.2513LF
- 40.1975LF
- 54.9796LF
- 65.4744LF
- 73.5688LF

- Number of measure points: 11

Measurement format: LOG MAG and PHASE (In the case of dual trace, LOG MAG measurement data is output as array data XA(*) and PHASE measurement data is output as array data XB(*)..)

XA(*): Each LOG MAG measurement data	XB(*): Each PHASE measurement data
- 68.1109	166.2703LF
- 60.8254	160.9476LF
- 50.9415	155.3348LF
- 36.1592	138.2429LF
- 9.5055	59.1865LF
- 0.9984	173.1146LF
- 15.2513	- 64.6413LF
- 40.1975	- 124.2295LF
- 54.9796	- 139.9966LF
- 65.4744	- 148.1749LF
- 73.5688	- 153.6706LF

- (7) Entering the title

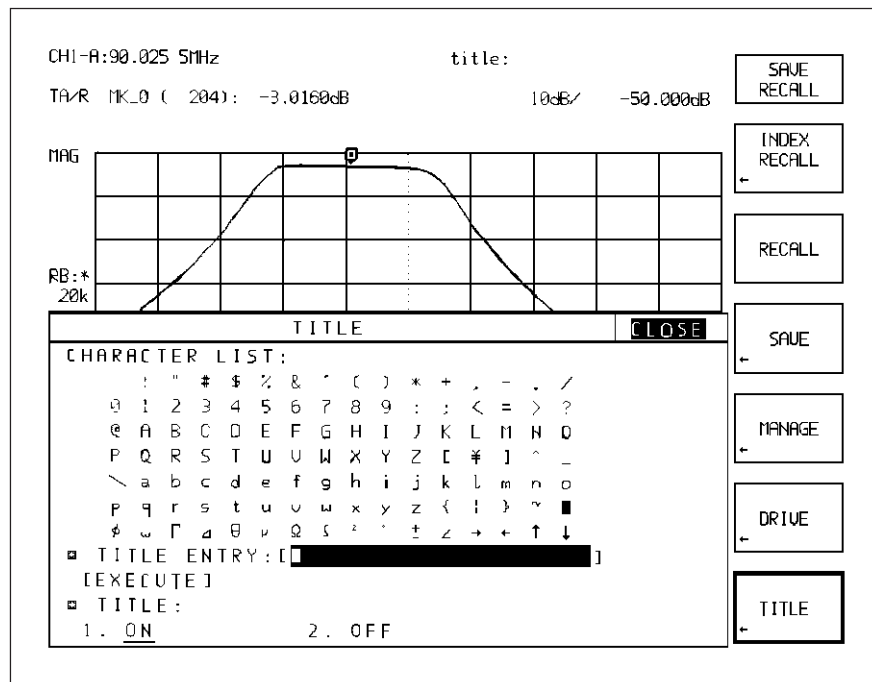

- STEP1: Moves the cursor to the character you wish to enter selected from the Character List, using the ten-key or the rotary knob.
- STEP2: Pressing the Enter key here completes the entry of a character.
- STEP3: Repeat the above operations for the rest of required characters.
- STEP4: When a character string you wish to enter as a title is completed, use the  key to move the cursor to EXECUTE and press the Enter key.

Now, the title entry has been completed.

Section 10 Hard Copy and Remote Control (Copy/Memory Group)

Section 11 System

This section explains important functions whose settings need not be changed frequently.

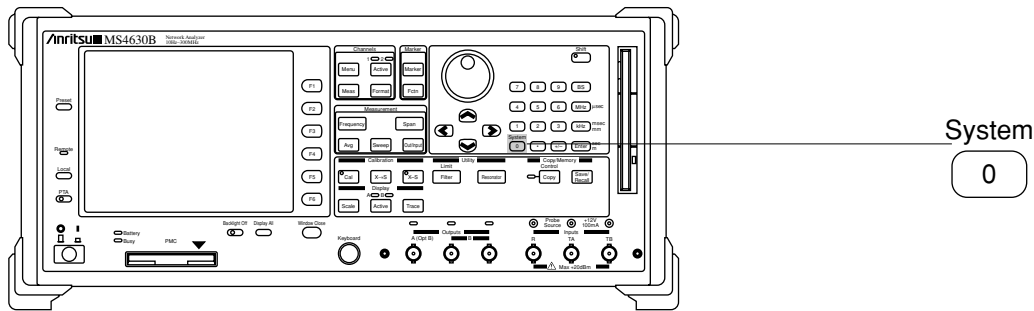

Front panel

Major functions

- Marker setting mode and impedance measurement mode
- Setting the date and time
- Displaying the optional unit state
- Setting a display color
- Displaying the self-test result

Press the ^{System} key and make various settings using the displayed soft key and menu.

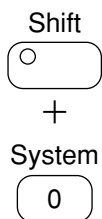

Make other system settings and display states.

11.1	Switching between Marker Setting Modes (Frequency/Point) ...	11-2
11.2	Selecting an Impedance Measurement Method (Bridge/Transfer Method)	11-2
11.3	Setting the Date and Time	11-3
11.4	Checking Options	11-3
11.5	Setting a Display Color	11-4
11.6	Displaying a Self-test Result	11-4

Section 11 System

11.1 Switching between Marker Setting Modes (Frequency/Point)

Effective key: Ten-key, rotary knob (◀) (▶) key

SYSTEM	Description of function
USER PRESET CLOCK OPTION COLOR SELF TEST --	Allows you to set a marker setting mode and an impedance measurement mode.

-USER PRESET- WINDOW

- MKR SETTING MODE: Set a position/frequency marker.
- IMPD MEASUREMENT: ~

11.2 Selecting an Impedance Measurement Method (Bridge/Transfer Method)

Effective key: Ten-key, rotary knob (◀) (▶) key

SYSTEM	Description of function
USER PRESET CLOCK OPTION COLOR SELF TEST --	Allows you to set a marker setting mode and an impedance measurement mode.

-USER PRESET- WINDOW

- MKR SETTING MODE: ~
- IMPD MEASUREMENT:
 - REFLECTION: Select a method of measuring impedance using reflection (bridge).
 - TRANSFER: Select a method of measuring impedance using transfer (pi circuit jig).

11.3 Setting the Date and Time

Effective key: Ten-key

SYSTEM	Description of function
USER PRESET CLOCK OPTION COLOR SELF TEST --	Allows you to set the clock.

-CLOCK- WINDOW

-
- DATE: Set the Gregorian year, month, and day (yy/mm/dd).
- TIME: Set the hour, minute, and second (hh:mm:ss) based on the 24-hour system.

11.4 Checking Options

SYSTEM	Description of function
USER PRESET CLOCK OPTION COLOR SELF TEST --	Display installation states of optional units.

-OPTION- WINDOW

-
- OPTION: Display installation states of optional units.
- INPUT TBch: Input port TB
- OUTPUT ATT (ELECTRICAL) : Output attenuator (electrical) (not used now).
- OUTPUT ATT (MECHANICAL) : Output attenuator (mechanical).
- OUTPUT DIVIDER: 2-/3-branch output
- REF OSC (10 MHZ): Highly stable reference resonator
- PMC DRIVE: PMC (Plug-in Memory Card)
- RS232C/CENTRONICS I/F: RS232C/Centronics interface
- ACCESORY: Indicates connection states of accessories.
- 75 Ω ADAPTER: 75 Ω conversion adapter (MA4605A)

Section 11 System

11.5 Setting a Display Color

Effective key: Ten-key, rotary knob

SYSTEM	Description of function
USER PRESET CLOCK OPTION COLOR SELF TEST --	Allows you to set a display color.

-COLOR- WINDOW

- PLANE: Select an item whose color is to be changed.
- COLOR No: Specify a color with a number (0 to 15).

11.6 Displaying a Self-test Result

SYSTEM	Description of function
USER PRESET CLOCK OPTION COLOR SELF TEST --	Executes the self diagnosis and displays the results.

-SELF-TEST- WINDOW

This executes the self diagnosis of the equipment interior and displays the result.

Section 12 Measurements

This section gives typical examples of measurements of transfer and reflection characteristics and impedance. For the calibration to be performed before measurements, see Section 8. For key operations, see Sections 3-7.

All operation procedures covered in this section must start with presetting. Defaults of typical parameters are listed below. For details on other defaults, see the List of Defaults in Appendix B.

- Measurement channel CH1
- Analysis port TA/R
- Analysis forma LOGMAG
- Number of measurement points 501
- RBW AUTO
- Sweep Time AUTO
- Output port B output
- Output power -6 dBm

12.1 Analyzing a Network.....	12-2
12.1.1 Transfer characteristics	12-2
12.1.2 Reflection characteristics	12-4
12.2 Basics of Measurement	12-6
12.3 Measuring Transfer Characteristics	12-7
12.3.1 Measurement of logarithmic magnitude: Single trace ...	12-7
12.3.2 Measuring a magnitude and phase simultaneously:	
Dual trace	12-9
12.3.3 Measuring a group delay	12-10
12.3.4 Measuring impedance using a transfer method	12-13
12.4 Measuring Reflection Characteristics	12-16
12.4.1 Measurement of return loss	12-16
12.4.2 Measuring a reflection coefficient	12-18
12.4.3 Measuring impedance	12-21
12.5 Measuring Transfer and Reflection Characteristics	
Simultaneously (Option 12)	12-24
12.6 Measuring a Filter	12-27
12.7 Measuring a Resonator	12-29

Section 12 Measurements

12.1 Analyzing a Network

The network analyzer analyzes a network by measuring its transfer and reflection characteristics using a sine wave. Transfer characteristics are represented by E_{tr}/E_{in} (E_{tr} means a transmission voltage and E_{in} means an input voltage) and reflection characteristics are represented by E_{re}/E_{in} (E_{re} means a reflection voltage and E_{in} mean an input voltage). The transfer and reflection characteristics of the network can be obtained by measuring the ratio between E_{tr} and E_{in} magnitudes, ratio between E_{re} and E_{in} magnitudes, the difference in phase between E_{tr} and E_{in} , and the difference in phase between E_{re} and E_{in} .

In addition to the basic items, such as an magnitude and phase, that represent transfer and reflection characteristics of a network, the items listed below which are obtained from the basic items are used. When combined with a reflection bridge, this system can measure transfer and reflection characteristic. When not combined with a reflection bridge, this system can measure only transfer characteristics.

- Transfer characteristics:
- Magnitude
 - Phase
 - Group delay time
 - Transfer coefficient
 - Impedance
 - Admittance

- Reflection characteristics:
- Magnitude
 - Phase
 - Reflection coefficient
 - VSWR
 - Impedance
 - Admittance

12.1.1 Transfer characteristics

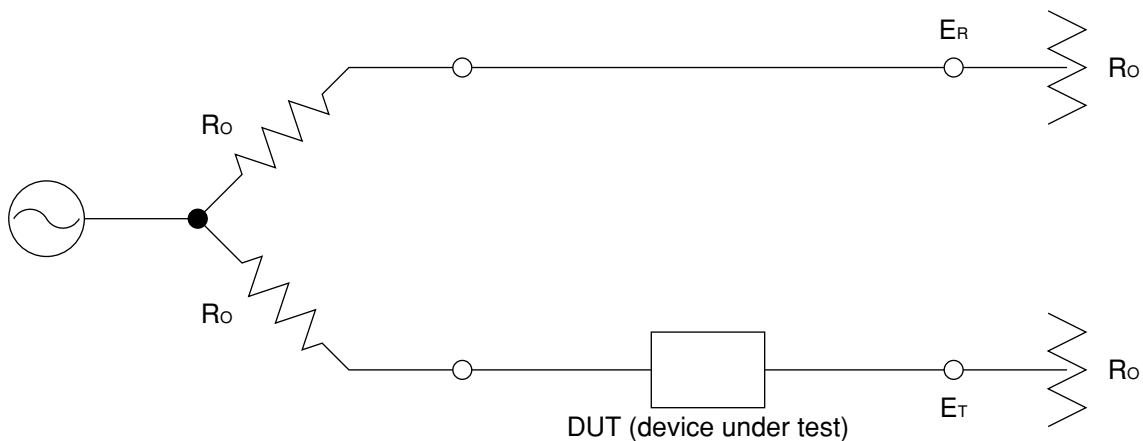

Measurement of transfer characteristics

12.1 Analyzing a Network

In the above figure, R_0 is the characteristic impedance of the measurement system and E_R and E_T are reference and test end voltages.

In this case, the transfer coefficient K is found by

$$K = |K| \cdot e^{j\phi} = \frac{E_T}{E_R} \dots\dots\dots (A)$$

Where, $|K|$: Magnitude ratio, ϕ : Phase difference (rad)

Magnitude A , phase θ , and group delay time τ are found by

$$A = 20 \log_{10} |K| \quad (\text{dB}) \dots\dots\dots (B)$$

$$\theta = \frac{360}{2\pi} \phi \quad (\text{deg}) \dots\dots\dots (C)$$

$$\tau \approx - \frac{\Delta\phi}{\Delta\omega} = - \frac{1}{360} \cdot \frac{\Delta\theta}{\Delta f} \quad (\text{S}) \dots\dots\dots (D)$$

Where, θ : Phase (deg), ω : Angular frequency (rad/s)

$\Delta\theta$: Phase difference (rad), Δf : Frequency difference (Hz)

The magnitude and phase are measured directly and displayed on the screen. The absolute value of the transfer coefficient is calculated from equation (B).

The group delay time is calculated from equation (D) after obtaining the difference in phase $\Delta\theta$ between

$$f_0 + \frac{\Delta f}{2}, f_0 - \frac{\Delta f}{2}$$

Δf is determined by

$$\Delta f = (\text{Frequency span [Hz]}) \times \frac{(\text{Delay aperture [%]})}{100}$$

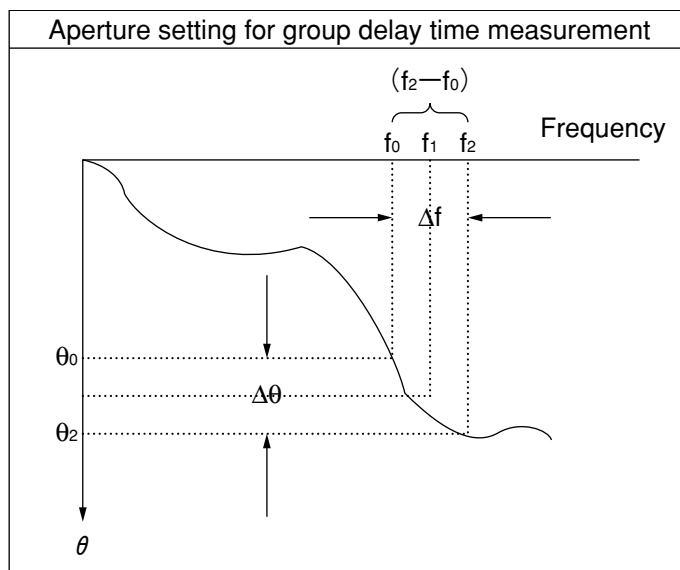

Section 12 Measurements

12.1.2 Reflection characteristics

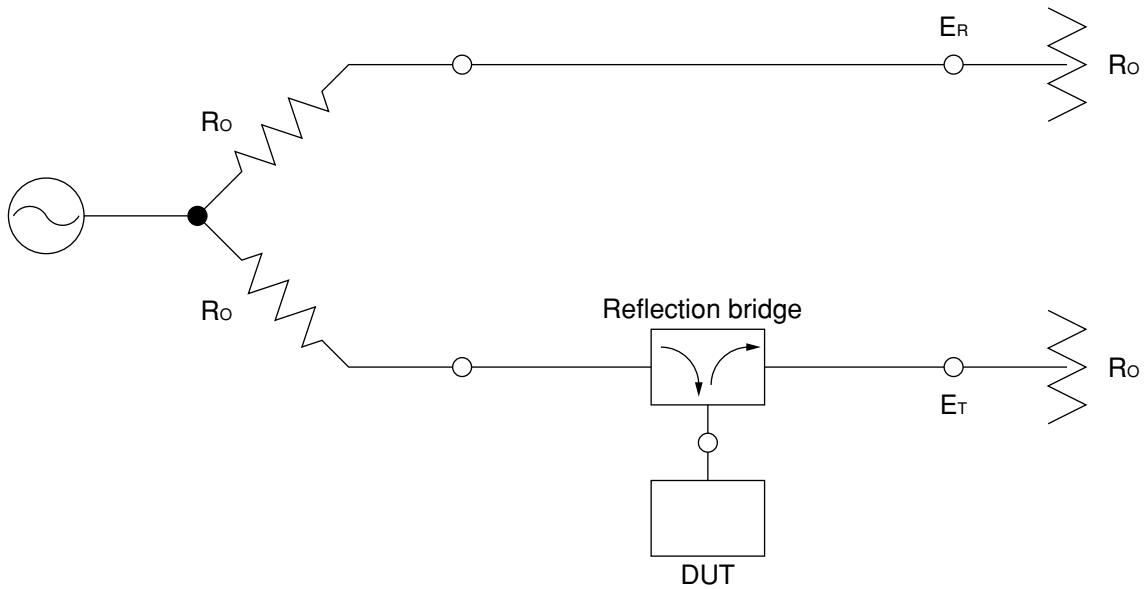

Measurement of reflection characteristics

In the above figure, R_o is the characteristic impedance of the measurement system and E_R and E_T are reference and test end voltages.

In this case, the reflection coefficient Γ is found by

$$\Gamma = |\Gamma| \cdot e^{j\phi} = \frac{E_T}{E_R} \dots\dots\dots (A)$$

Where, $|\Gamma|$: Magnitude ratio, ϕ : Phase difference (rad)

The return loss is expressed as follows:

$$\delta = 20 \log |\Gamma| \quad (\text{dB}) \dots\dots\dots (B)$$

$$\theta = \frac{360}{2\pi} \phi \quad (\text{deg}) \dots\dots\dots (C)$$

The return loss and phase are measured directly and displayed on the screen. The absolute value of the reflection coefficient is calculated from equation (B).

Using the reflection coefficient Γ , the impedance and admittance are found by

$$Z_x = |Z_x| e^{j\theta} = \frac{1 + \Gamma}{1 - \Gamma} \cdot R_o = R_x + jX_x \dots\dots\dots (D)$$

$$R_x = \text{Re}(Z_x)$$

$$X_x = \text{Im}(Z_x)$$

This is expressed by the following series equivalent circuit:



Series equivalent circuit (impedance)

12.1 Analyzing a Network

The Q and D of the inductance or capacitance of this circuit are expressed as follows:

$$Q = \frac{X_x}{R_x} \dots\dots\dots (E)$$

$$D = \frac{1}{Q} \dots\dots\dots (F)$$

$$Y_x = |Y_x| e^{j\theta''} = \frac{1}{Z_x} = \frac{1-\Gamma}{1+\Gamma} \cdot \frac{1}{R_0} = G_x + jB_x \dots\dots\dots (G)$$

$$G_x = \text{Re}(Y_x)$$

$$B_x = \text{Im}(Y_x)$$

This can be expressed by the following parallel equivalent circuit:

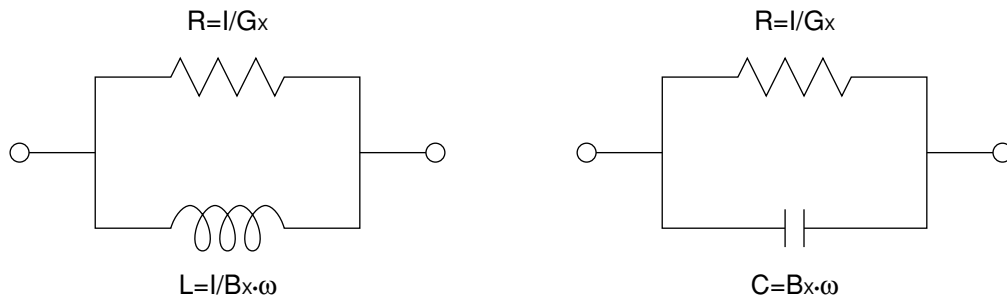

Parallel equivalent circuit (admittance)

The Q and D of the inductance or capacitance of this circuit are expressed as follows:

$$Q = \frac{G_x}{B_x} \dots\dots\dots (H)$$

$$D = \frac{1}{Q} \dots\dots\dots (I)$$

When negative resistances are measured, the above values are expressed as follows:

- $|\Gamma| > 1$
- $Q < 0$
- $D < 0$
- $R_x < 0$
- $G_x < 0$
- $|Z| \angle \theta'$ $90^\circ < \theta' < 180^\circ$ or $-90^\circ > \theta' > -180^\circ$
- $|Y| \angle \theta''$ $90^\circ < \theta'' < 180^\circ$ or $-90^\circ > \theta'' > -180^\circ$

Section 12 Measurements

12.2 Basics of Measurement

This section explains important basic items that must be set in addition to measurement items.

(1) Dynamic range

(a) Dynamic range

A dynamic range is defined from the maximum input level to the average noise level. “Maximum input level” does not mean the absolute maximum rating specified for protecting the system but it means the maximum input level specified for maintaining the linearity of the receiver circuit (i.e., input range of each reception port). To make measurements accurately, a sufficient dynamic range must be allocated for the DUT and the highest possible part of the dynamic range must be used.

(b) Output power and input attenuator

To use the highest possible part of the dynamic range, adjust the output power to the input range when measuring an ordinary passive circuit. When measuring a passive circuit which requires a large insertion loss and wide dynamic range, increase the output power to the maximum so that overload does not occur. However, the output level must be lowered to the input range when calibrating the measuring system.

For a DUT which has a gain (e.g., amplifier), the output power must be lowered below the input attenuator level by the gain. If the input range of the receiver circuit is exceeded, the OVER message lamp lights. Reduce the test port power or increase the input range.

(c) Resolution bandwidth (RBW)

The average noise level of the receiver circuit is determined by the resolution bandwidth (RBW). The resolution bandwidth must be selected according to the dynamic range.

(2) Sweep time and number of measurement points

(a) Sweep time

The narrower the resolution bandwidth, the longer the sweep time. Normally, an optimum sweep time is automatically set according to the resolution bandwidth.

(b) Number of measurement points

Short sweep times are required, for example, when adjusting a DUT. You can select the number of measurement points out of 11, 21, 51, 101, 251, 501, and 1001. To reduce the sweep time, decrease the number of measurement points.

12.3 Measuring Transfer Characteristics

Transfer characteristics are the most basic measurement items used for network analysis. Using a band pass filter with a center frequency of 90 MHz, carry out the following measurements:

- Measurement of logarithmic magnitude: Single trace
- Simultaneous measurement of magnitude and phase: Dual trace
- Measurement of impedance by transfer method

12.3.1 Measurement of logarithmic magnitude: Single trace

When measuring the logarithmic magnitude, select LOGMAG as an analysis format. When this format is selected, the X-axis represents frequencies and the Y-axis represents magnitude ratios in dB.

(1) Setup

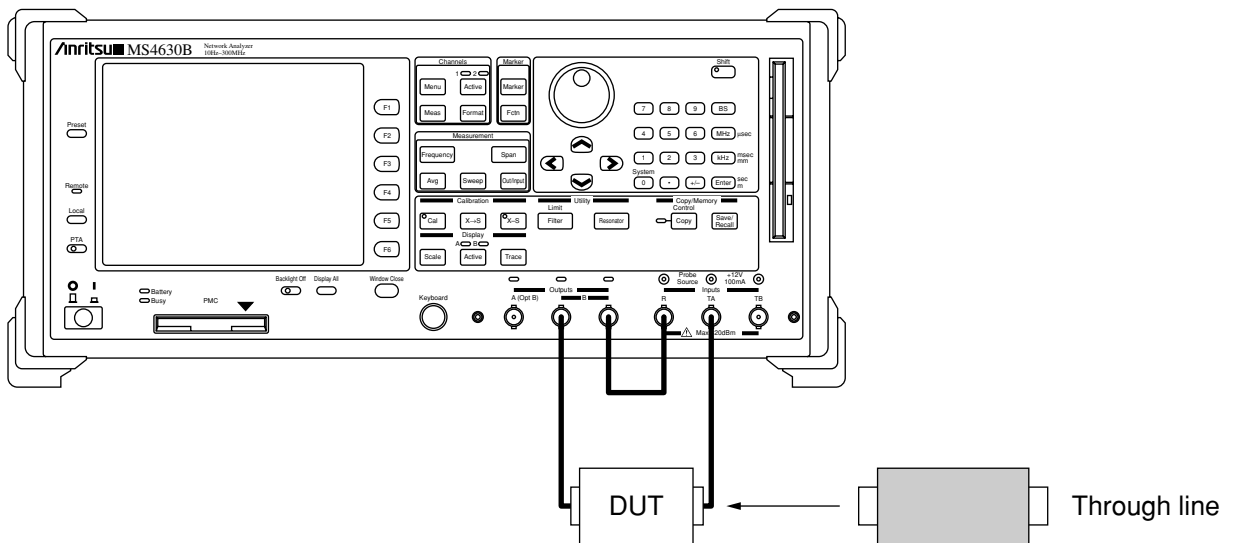

Section 12 Measurements

(2) Measurement procedure

Step	Description of operation
1	Configure a measuring system to which a DUT (device under test) is connected, according to the Setup Drawing.
2	Press <input type="button" value="Out/Inpt"/> in the Measurement group. Press the <input type="button" value="POWER"/> soft key and set the following parameter: POWER: 0 dB
3	Press <input type="button" value="Frequency"/> in the Measurement group. Press the <input type="button" value="CENTER"/> soft key and set the following parameter: CENTER: 90 MHz
4	Press <input type="button" value="Span"/> in the Measurement group and set the following parameter: SPAN: 100 kHz
5	Disconnect the DUT from the measuring system and connect a through line.
6	Press <input type="button" value="X→S"/> to perform normalization. (The <input type="button" value="X→S"/> key lamp lights.)
7	Disconnect the through line from the measuring system and reconnect the DUT.
8	Press <input type="button" value="Scale"/> in the Display group. Using soft keys, adjust the scale and offset so that the trace waveform is displayed at the optimum position on the screen.

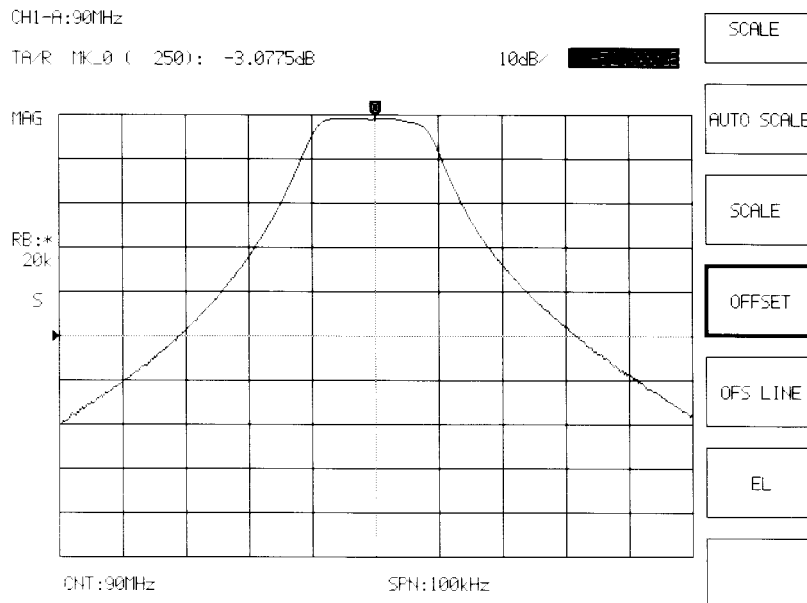

12.3.2 Measuring a magnitude and phase simultaneously: Dual trace

Measure the magnitude in the analysis format, MAG & PHA mode.

Trace A indicates the logarithmic magnitude and trace B indicates the phase.

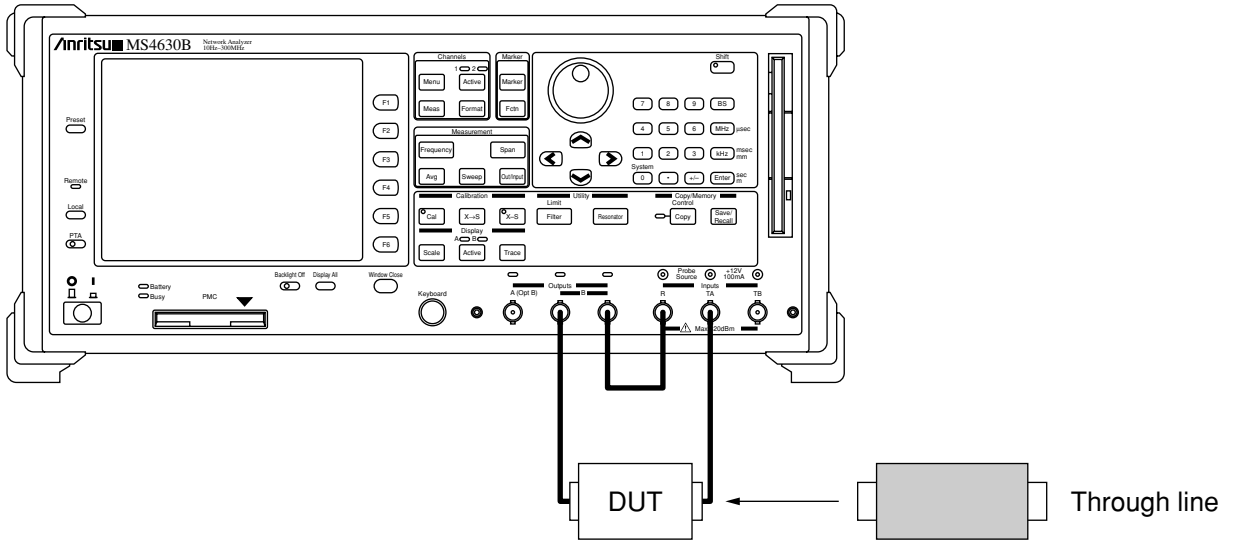

(1) Setup



(2) Measurement procedure

Step	Description of operation
1	Configure a measuring system to which a DUT (device under test) is connected, according to the Setup Drawing.
2	Press Format in the Channels group. Press the MAG & PHA soft key.
3	Press Out/Input in the Measurement group. Press the POWER soft key and set the following parameter: POWER: 0 dBm
4	Press Frequency in the Measurement group. Press the CENTER soft key and set the following parameter: CENTER: 90 MHz
5	Press Span in the Measurement group and set the following parameter: SPAN: 100 kHz
6	Disconnect the DUT from the measuring system and connect a through line.
7	Press X→S to perform normalization. (The X→S lamp lights.)
8	Disconnect the through line from the measuring system and reconnect the DUT.
9	Make sure the A lamp on Active in the Display group is lit, then press Scale . Using soft keys, adjust the scale and offset so that the trace A waveform (magnitude) is displayed at the optimum position on the screen.

Section 12 Measurements

Step	Description of operation
10	Press  in the Display group to turn on the B lamp, then press  . Using soft keys, adjust the scale and offset so that the trace B waveform (phase) is displayed at the optimum position on the screen.

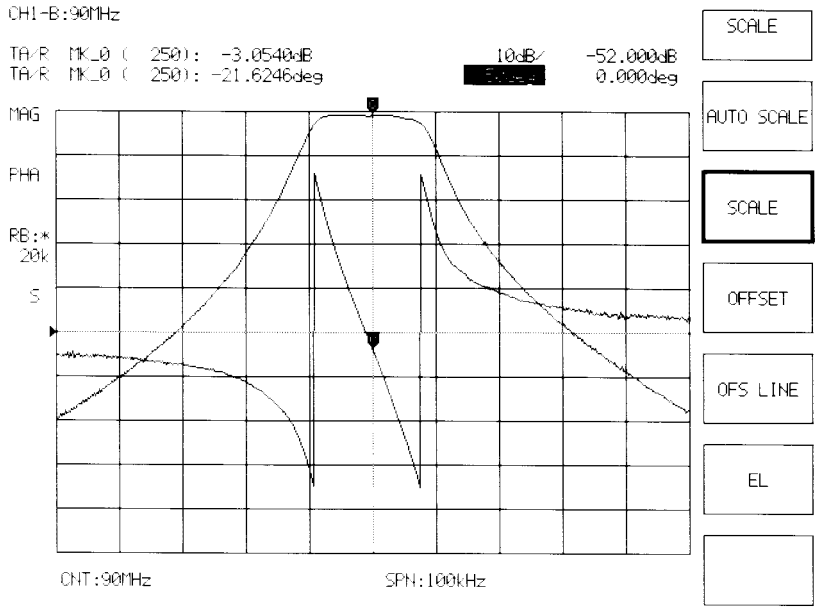

12.3.3 Measuring a group delay

Group delay τ is obtained by calculating the difference in phase between the aperture frequency and Δf from the following equation:

$$\tau = \left(\frac{1}{2\pi} \right) \left(\frac{\Delta \theta}{\Delta f} \right)$$

On this system, do not specify Δf directly but specify a delay aperture (ratio (%) to the frequency span). To minimize the measurement error, make settings so that the best resolution and the maximum delay can be obtained at the minimum smoothing aperture (%).

(1) Setup

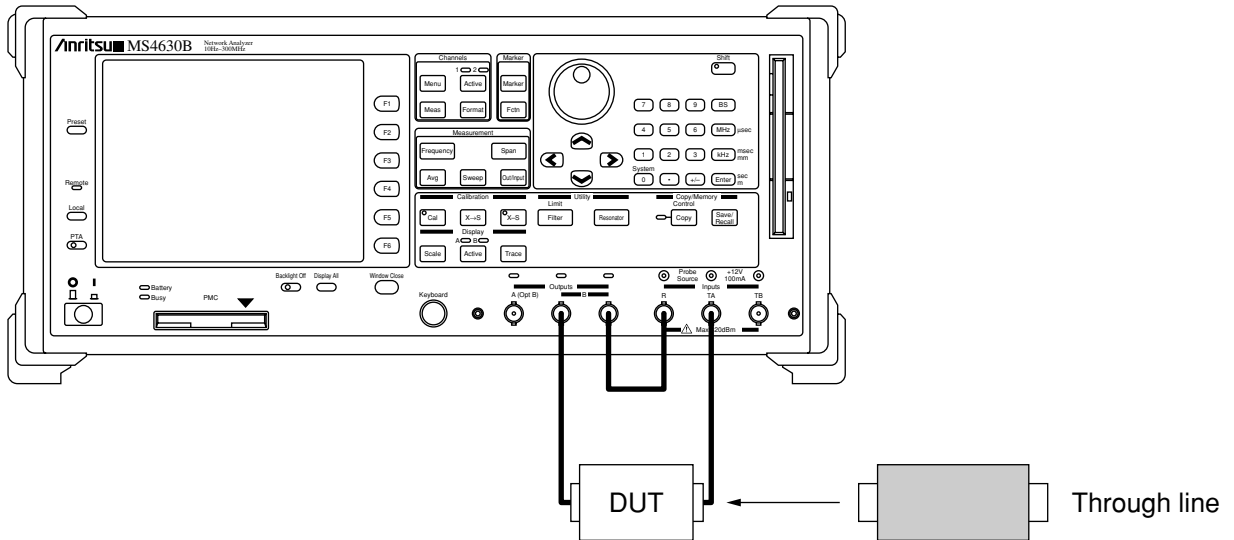

(2) Measurement procedure

Step	Description of operation
1	Configure a measuring system to which a DUT (device under test) is connected, according to the Setup Drawing.
2	Press Format in the Channels group. Press the DELAY soft key.
3	Press Out/Input in the Measurement group. Press the POWER soft key and set the following parameter: POWER: 0 dBm
4	Press Frequency in the Measurement group. Press the CENTER soft key and set the following parameter: CENTER: 90 MHz
5	Press Span in the Measurement group and set the following parameter: SPAN: 50 kHz
6	Press Avg in the Measurement group. Press the RBW soft key and set the following parameter: RBW: 1 kHz
7	Disconnect the DUT from the measuring system and connect a through line.
8	Press Cal , then press the RESPONSE -default- soft key. A sweep is performed to obtain CAL data, then the RESPONSE -default- soft key changes to the RESPONSE -created- soft key.
9	Press the CAL ON soft key. The calibration function is turned on.
10	Disconnect the through line from the measuring system and reconnect the DUT.

Section 12 Measurements

Step	Description of operation
------	--------------------------

- 11 Press in the Measurement group. Pressing the soft key allows you to enter a smoothing aperture value.
 To minimize the measurement error, enter the minimum value (%) which will maximize the peak values (marked with ○) on the waveform.

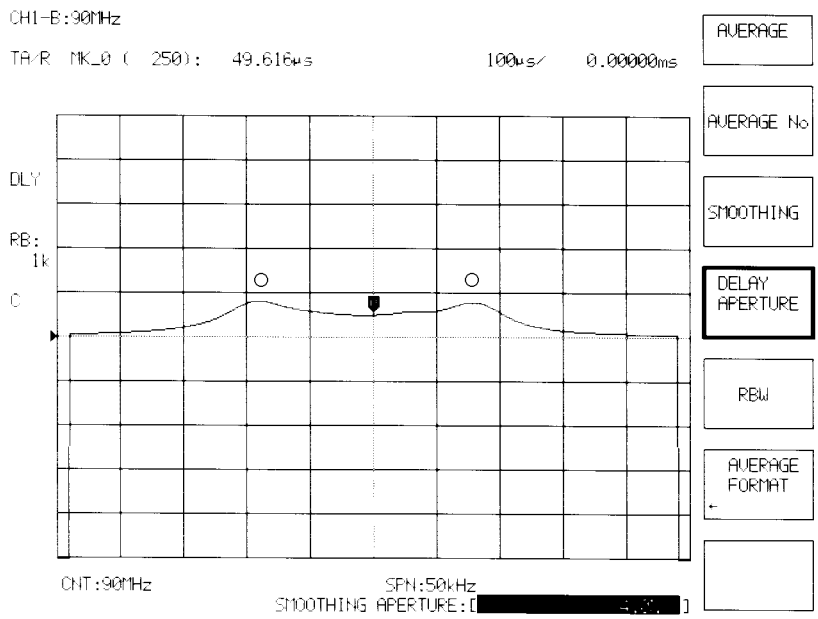

- 12 Press in the Display group. Using soft keys, adjust the scale and offset so that the trace waveform is displayed at the optimum position on the screen.

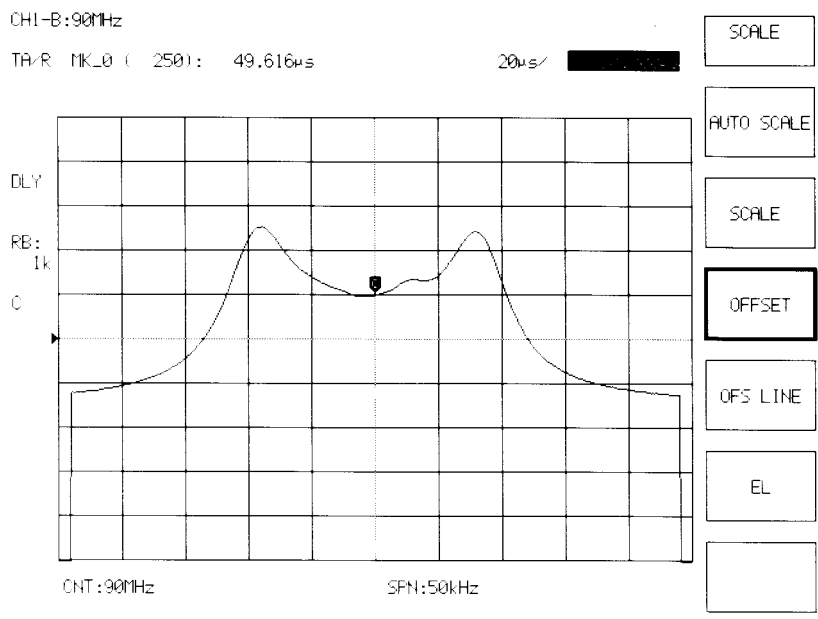

NOTE:

The minimum smoothing aperture value and the setting resolution depend on the number of measurement points.

12.3.4 Measuring impedance using a transfer method

This system can measure impedance using two methods: a method by which a reflection characteristic is measured using a reflection bridge and a method by which a transfer characteristic is measured. This section explains the procedure for measuring impedance using the latter method (transfer method).





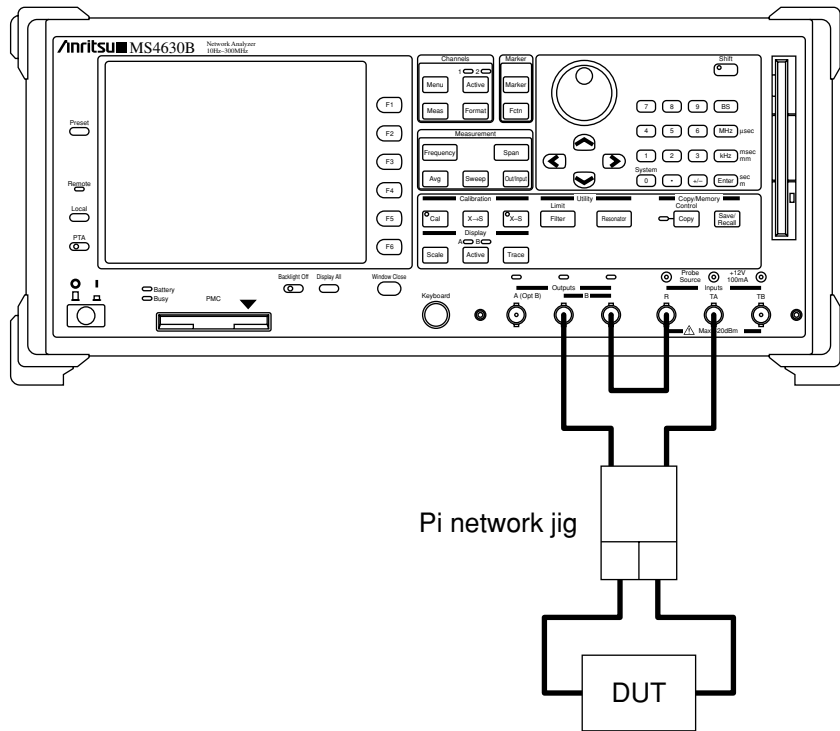









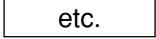

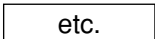
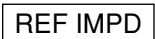

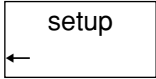

When the transfer method is used, a pi network jig is used normally. Let's measure the impedance of the 1 μH inductance using a pi network jig whose measurement terminal impedance is 12.5 Ω and obtain the R-L (or C) series equivalent constant.

(1) Setup

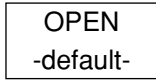
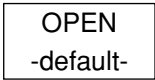
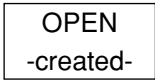
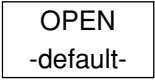

Section 12 Measurements

(2) Measurement procedure

Step	Description of operation
1	<p>Press , then press  (SYSTEM) on the numeric keypad.</p> <p>Press the  soft key and select TRANSFER (transfer method) for IMPD MEASUREMENT.</p>
<p>NOTE: The contents of SYSTEM do not change if presetting is performed.</p>	
2	Configure a measuring system to which a DUT (device under test) is connected, according to the Setup Drawing.
3	Press  in the Channels group. Press the  soft key once to select IMPD CHART (impedance chart).
4	Press  in the Measurement group. Press the  soft key once, press  , and set the following parameter: REFERENCE IMPEDANCE: 12.5 Ω
5	Press  in the Measurement group. Press  and set the following parameter: RBW: 1 kHz
6	Press  in the Measurement group. Using a soft key, set the following parameter: START: 1 MHz
7	Press  in the Measurement group and set the following parameter: STOP: 50 MHz
8	Press  , then press the  soft key. Select CAL METHOD from the CALIBRATION window, then press  .
9	Select PI-NET from the CAL METHOD window, then press  .
10	Disconnect the DUT from the measuring system. Press  , then press the  soft key. A sweep is performed to obtain CAL data, then the  soft key changes to the  soft key.
11	Connect a jumper pin (0 Ω) to the pi network and press  . A sweep is performed and the  soft key changes to the  soft key.
12	Press the  soft key. The calibration function is turned on.
13	Disconnect the jumper pin from the measuring system and reconnect the DUT.

12.3 Measuring Transfer Characteristics

Step	Description of operation
14	Press <input type="button" value="Marker"/> in the Marker group and adjust the marker to the frequency at which impedance is to be measured. The impedance at the marker point is displayed as “_Ω_deg”.
15	Change the marker value to the R-L (or C) series equivalent constant. Press <input type="button" value="Format"/> in the Channels group, then press the <input type="button" value="more"/> soft key.
16	Select Rs/Ls or Cs for IMPD MKR FORMAT for IMPD CHART in the FORMAT window, then press the “Enter” key. The marker will change to “_Ω/_H(or F)”.

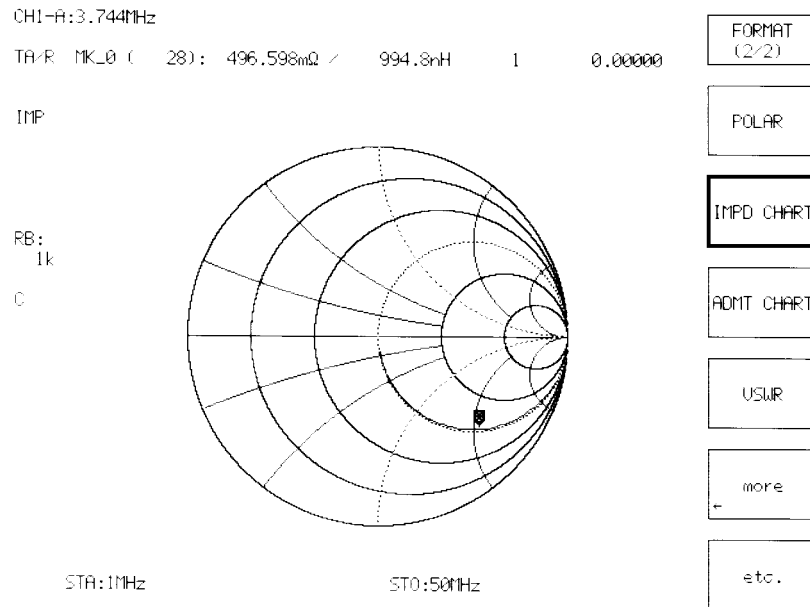

Section 12 Measurements

12.4 Measuring Reflection Characteristics

If the input impedance of a test device is different from the impedance of the measuring system when incident energy is applied to the input terminal on the test device, part of the energy is reflected. The ratio of the reflected energy to the incident energy is called a reflection coefficient, providing the standard for reflection measurement. For example, calculating the logarithm of the absolute value of the reflection coefficient gives a return loss. If a reflection coefficient is known, a VSWR can be calculated from $(1 + \text{Absolute value of reflection coefficient}) / (1 - \text{Absolute value of reflection coefficient})$. To calibrate the reflection measurement result, 1PORT OSL calibration can be used in addition to RESPONSE calibration. Let's carry out the following measurements using a band pass filter with a center frequency of 90 MHz:

- Measurement of return loss
- Measurement of reflection coefficient
- Measurement of impedance
- Measurement of VSWR

12.4.1 Measurement of return loss

Select a LOGMAG as an analysis format. When this format is selected, the ratio of reflected energy to incident energy is measured in dB, allowing you to read the return loss directly.

In the measurement procedure described below, RESPONSE calibration is used.

(1) Setup

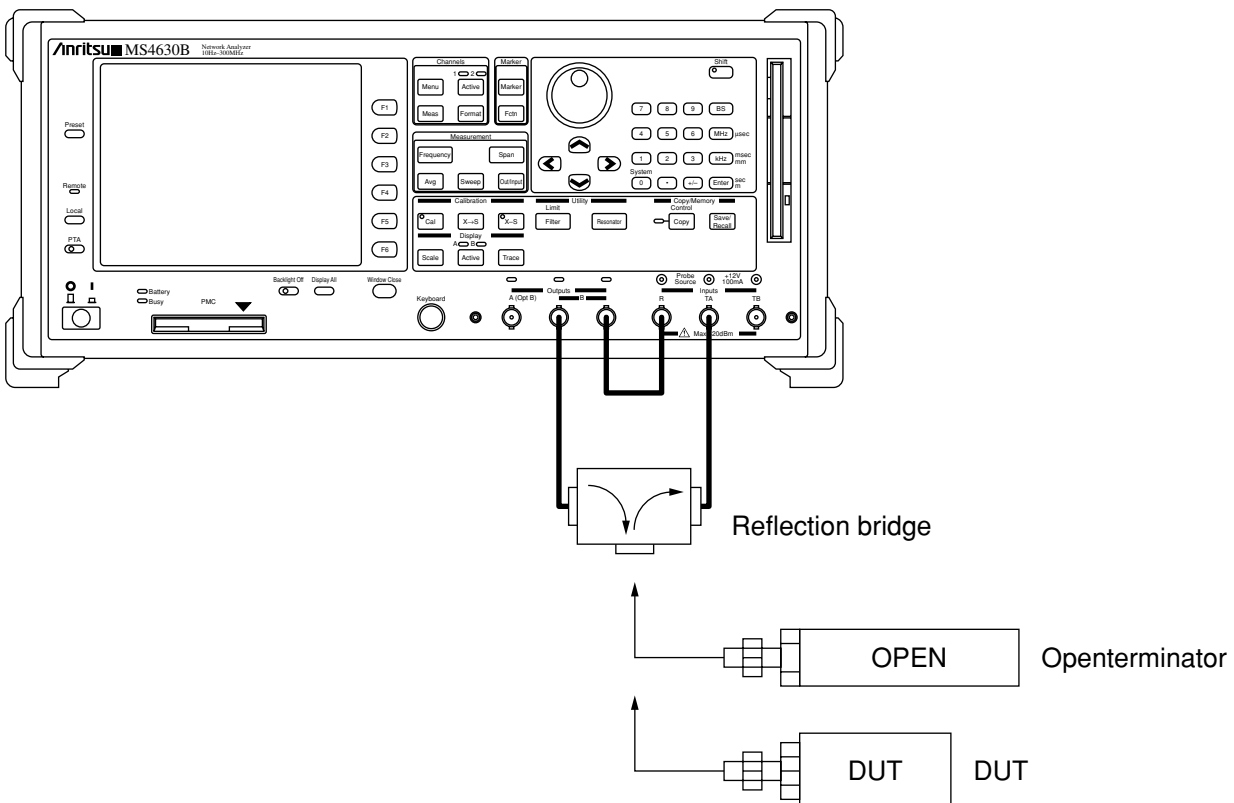

12.4 Measuring Reflection Characteristics

(2) Measurement procedure

Step	Description of operation
1	Configure a measuring system to which a DUT (device under test) is connected, according to the Setup Drawing.
2	Press Frequency in the Measurement group. Press the CENTER soft key and set the following parameter: CENTER: 90 MHz
3	Press Span in the Measurement group and set the following parameter: SPAN: 100 kHz
4	Press Avg in the Measurement group. Press the RBW soft key and set the following parameter: RBW: 1 kHz
5	Disconnect the DUT from the measuring system and connect a open terminator. Press Cal , then press the RESPONSE -default- soft key. A sweep is performed to obtain CAL data, then the RESPONSE -default- soft key changes to the RESPONSE -created- soft key.
6	Press the CAL ON soft key. The calibration function is turned on.
7	Disconnect the open terminator from the measuring system and reconnect the DUT.
8	Press the Scale key in the Display group. Using soft keys, adjust the scale and offset so that the trace waveform is displayed at the optimum position on the screen.

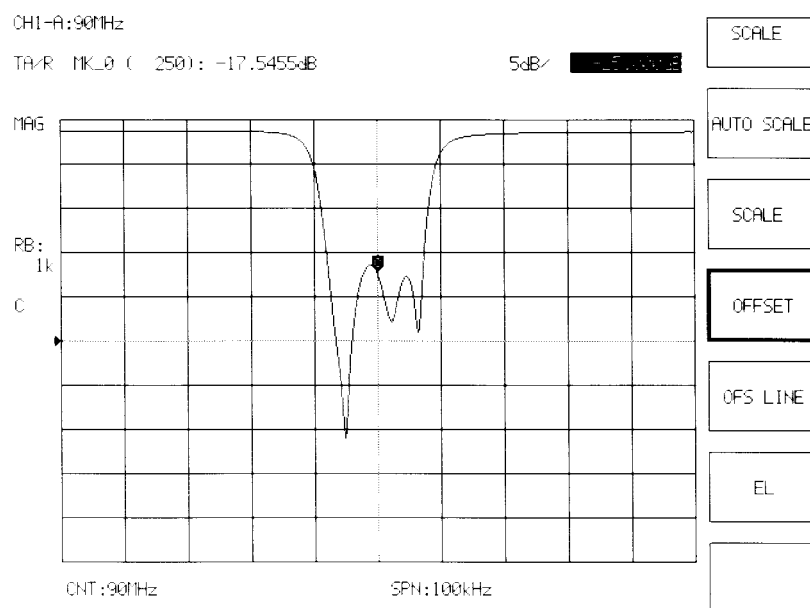

Section 12 Measurements

12.4.2 Measuring a reflection coefficient

When measuring a reflection coefficient, select a LIN MAG format and polar coordinate graph. In the LIN MAG mode, the ratio of reflected energy to incident energy is measured linearly, allowing you to read the absolute value of the reflection coefficient directly. The polar coordinate graph allows the complex reflection coefficient $\Gamma = \rho \angle \theta$ (ρ = absolute value of reflection coefficient, θ = phase angle) to be measured at the same time. Since the polar coordinate system does not have a frequency axis, use the marker to read frequencies. In the measurement procedure described below, 1PORT OSL calibration is used.

(1) Setup

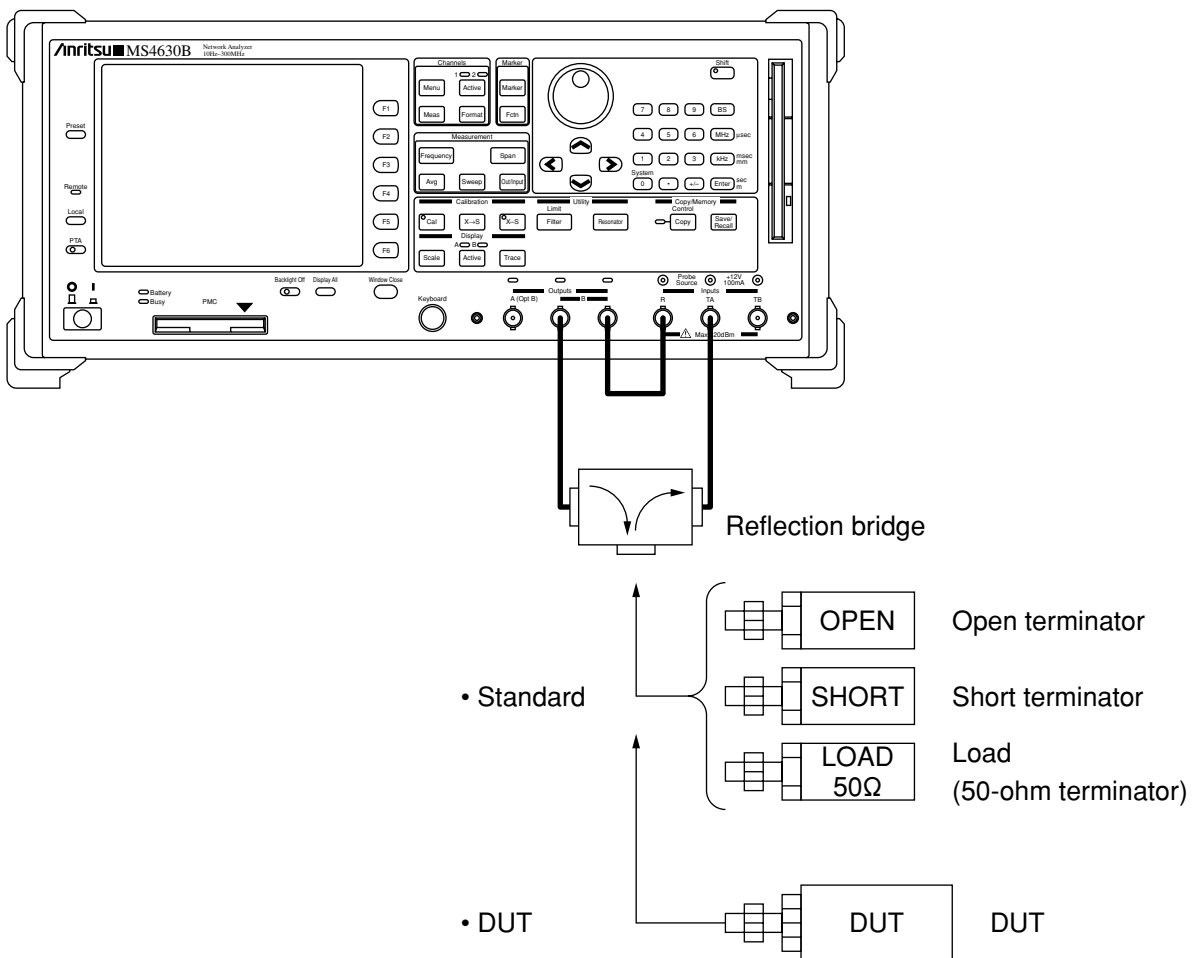

(2) Measurement procedure

Step	Description of operation
1	Configure a measuring system to which a DUT (device under test) is connected, according to the Setup Drawing.
2	Press <input type="button" value="Format"/> in the Measurement group, then press the “more” soft key. Press the <input type="button" value="etc."/> soft key once and press <input type="button" value="more"/> to open the FORMAT window. Select “<LIN MAG>” as a format, then press <input type="button" value="Enter"/> .
3	Press <input type="button" value="Frequency"/> in the Measurement group. Press the <input type="button" value="CENTER"/> soft key and set the following parameter: CENTER: 90 MHz
4	Press <input type="button" value="Span"/> in the Measurement group and set the following parameter: SPAN: 100 kHz
5	Press <input type="button" value="Avg"/> in the Measurement group. Press the <input type="button" value="RBW"/> soft key and set the following parameter: RBW: 1 kHz
6	Press <input type="button" value="Cal"/> , then press the <input type="button" value="setup"/> soft key. Select CAL METHOD from the CALIBRATION window, then press <input type="button" value="Enter"/> .
7	Select 1PORT OSL from the CAL METHOD window, then press <input type="button" value="Enter"/> .
8	Disconnect the DUT from the measuring system and connect an open terminator. Press <input type="button" value="Cal"/> , then press the <input type="button" value="OPEN -default-"/> soft key. A sweep is performed to obtain CAL data, then the <input type="button" value="OPEN -default-"/> soft key changes to the <input type="button" value="OPEN -created-"/> soft key.
9	Connect a short terminator and press <input type="button" value="SHORT -default-"/> .
10	Connect a load (50 Ω terminator) and press <input type="button" value="LOAD -default-"/> .
11	Press the <input type="button" value="CAL ON"/> soft key. The calibration function is turned on.
12	Disconnect the open terminator from the measuring system and reconnect the DUT.

Section 12 Measurements

Step	Description of operation
13	Press the Scale key in the Display group. Using soft keys, adjust the scale and offset so that the trace waveform is displayed at the optimum position on the screen.

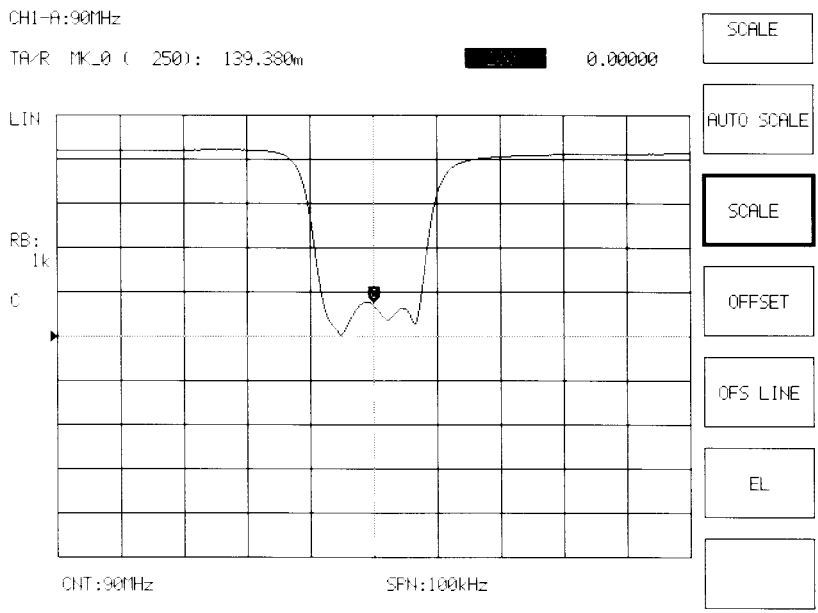

- 14 Switch the display format to the polar coordinate format.
 Press **Format** in the Channels group, then press **POLAR**. If **POLAR** is not displayed on the current screen, press **etc.** once.
 The readings of the active marker are measured values (absolute value of reflection coefficient and phase angle).

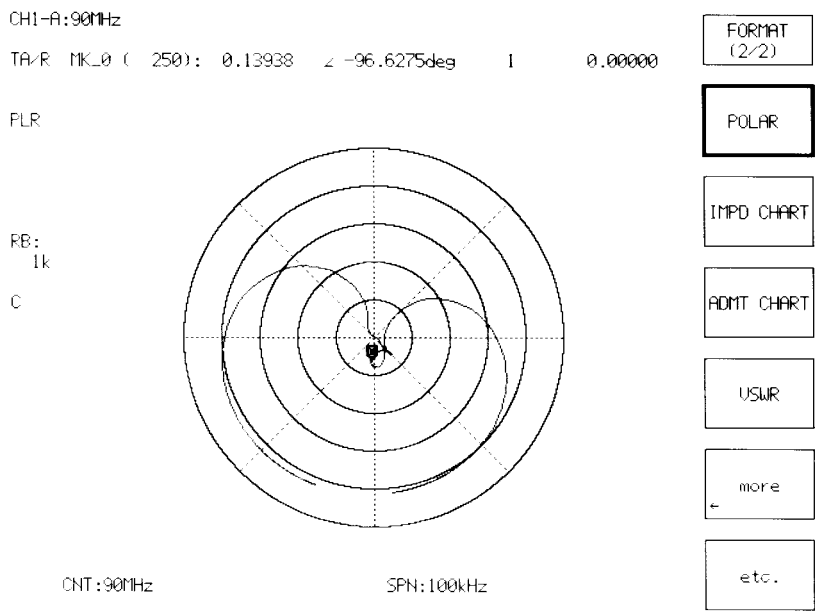

12.4.3 Measuring impedance





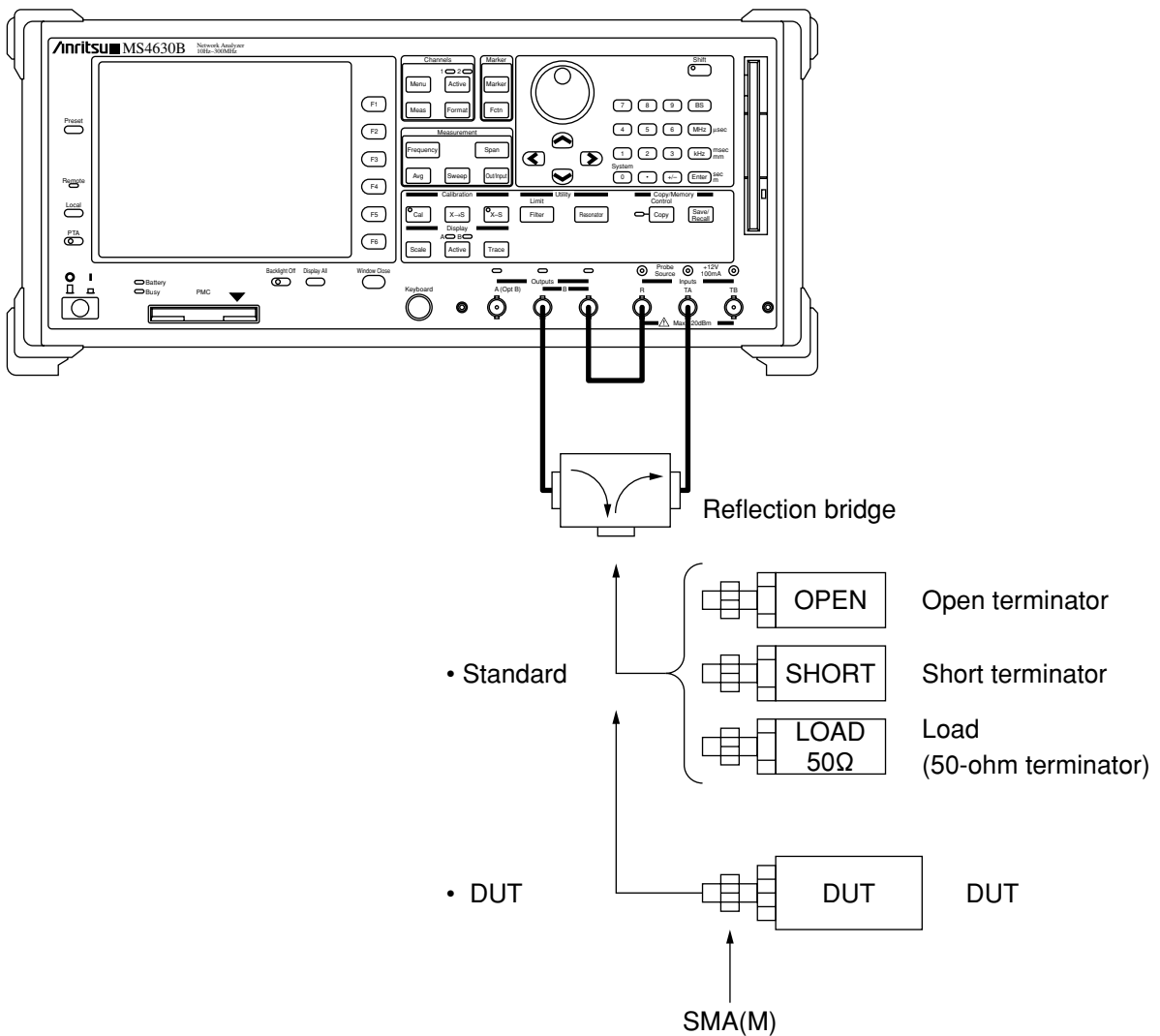







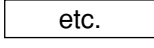
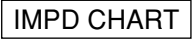

Measure the impedance of the device consisting of both resistance and reactance components and display it in the IMPD format (Smith chart). Press **Format**, then press the **more** soft key to display the FORMAT window. In the FORMAT window, select “1. $Z \angle \theta$ ”, “2. Rs/Ls”, Cs”, “3. Q/D”, or “4. $R+jX$ ” from the IMPD MARKER FORMAT for IMPD CHART menu. Then, the result of measurements at the active marker appears. In the measurement procedure described below, 1PORT OSL calibration is used.

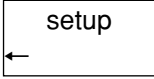
(1) Setup

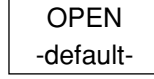
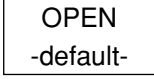
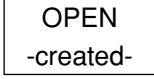
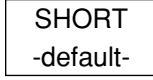
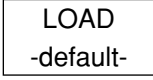

Section 12 Measurements

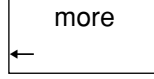
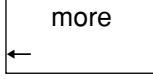
(2) Measurement procedure

Step	Description of operation
1	<p>Press , then press  (SYSTEM) on the numeric keypad.</p> <p>Press the  soft key and select REFLECTION (reflection method) for IMPD MEASUREMENT.</p>
NOTE:	
	The contents of SYSTEM do not change if presetting is performed.
2	Configure a measuring system to which a DUT (device under test) is connected, according to the Setup Drawing.
3	Press  in the Channels group. Press the  soft key once to select  .
4	Using the keys in the Measurement group and soft keys, set the following parameters: CENTER: 90 MHz SPAN: 100 kHz RBW: 1 kHz
5	<p>Press , then press the  soft key.</p> <p>Select CAL METHOD from the CALIBRATION window, then press .</p>
6	Select 1PORT OSL from the CAL METHOD window, then press  .
7	Disconnect the DUT from the measuring system and connect an open terminator.
	<p>Press , then press the  soft key. A sweep is performed to obtain CAL data, then</p> <p>the  soft key changes to the  soft key.</p>
8	Connect a short terminator and press  .
9	Connect a load (50 Ω terminator) and press  .
10	Press the  soft key. The calibration function is turned on.
11	Disconnect the open terminator from the measuring system and reconnect the DUT.
12	<p>Press  in the Channels group, then press . If  is not displayed on the current screen, press  once.</p>

12.4 Measuring Reflection Characteristics

Step	Description of operation
13	In the FORMAT window, select “1. $Z\angle\theta$ ”, “2. Rs/Ls”, Cs”, “3. Q/D”, or “4. R+jX” from the IMPD MARKER FORMAT for IMPD CHART menu. Then, the result of measurements at the active marker appears.
	1. $Z\angle\theta$ Absolute value of impedance/phase angle of impedance
	2. Rs/Ls, Cs Series resistance/series inductance or series capacitance
	3. Q/D Q/tan δ of resonator circuit
	4. R + jX Impedance resistance/reactance

The readings of the active marker are measured values (absolute value of reflection coefficient and phase angle).

CHI-A:90MHz
 TR/R MKL0 (250): 47.3623 Ω -j11.6486 Ω 1 0.00000

IMP

RB:
1k

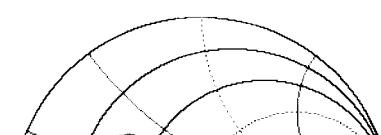

FORMAT (2/2)

POLAR

IMPD CHART

ADMT CHART

USWR

more

etc.

FORMAT

CLOSE

FORMAT:
 01.<LIN MAG > 02.<LIN & PHA> 03.<LIN & DLY>
 04.<REAL > 05.<IMAGINARY> 06.<REAL&IMAG>
 07.<LOG Z > 08.<LOG Z & θ > 09.<Q >
 10.<LOG Z & Q>
 IMPD MKR FORMAT for IMPD CHART:
 1. $Z\angle\theta$ 2. Rs/Ls.Cs 3. Q/D
 4. XXXXXXXXXX
 ADMT MKR FORMAT for ADMT CHART:
 1. $Y\angle\theta$ 2. Rp/Lp.Cp 3. Q/D
 4. G+jB
 PHASE OFFSET:[0.000deg]

Section 12 Measurements

12.5 Measuring Transfer and Reflection Characteristics Simultaneously (Option 12)

When this system is equipped with option 12 (3-channel receiver), connecting a reflection bridge to this system allows you to measure both transfer and reflection characteristics of the DUT at the same time.

Select CH1&CH2 (Dual CH measurement) as the measurement channel. Measure the reflection characteristic on the CH1 side. Measure the transfer characteristic on the CH2 side. As the output of the reflection bridge is connected to the reception port TA and the output of the DUT is connected to the reception port TB, the analysis port of CH1 must be connected to TA/R and the analysis port of CH2 must be connected to TB/R.

(1) Setup

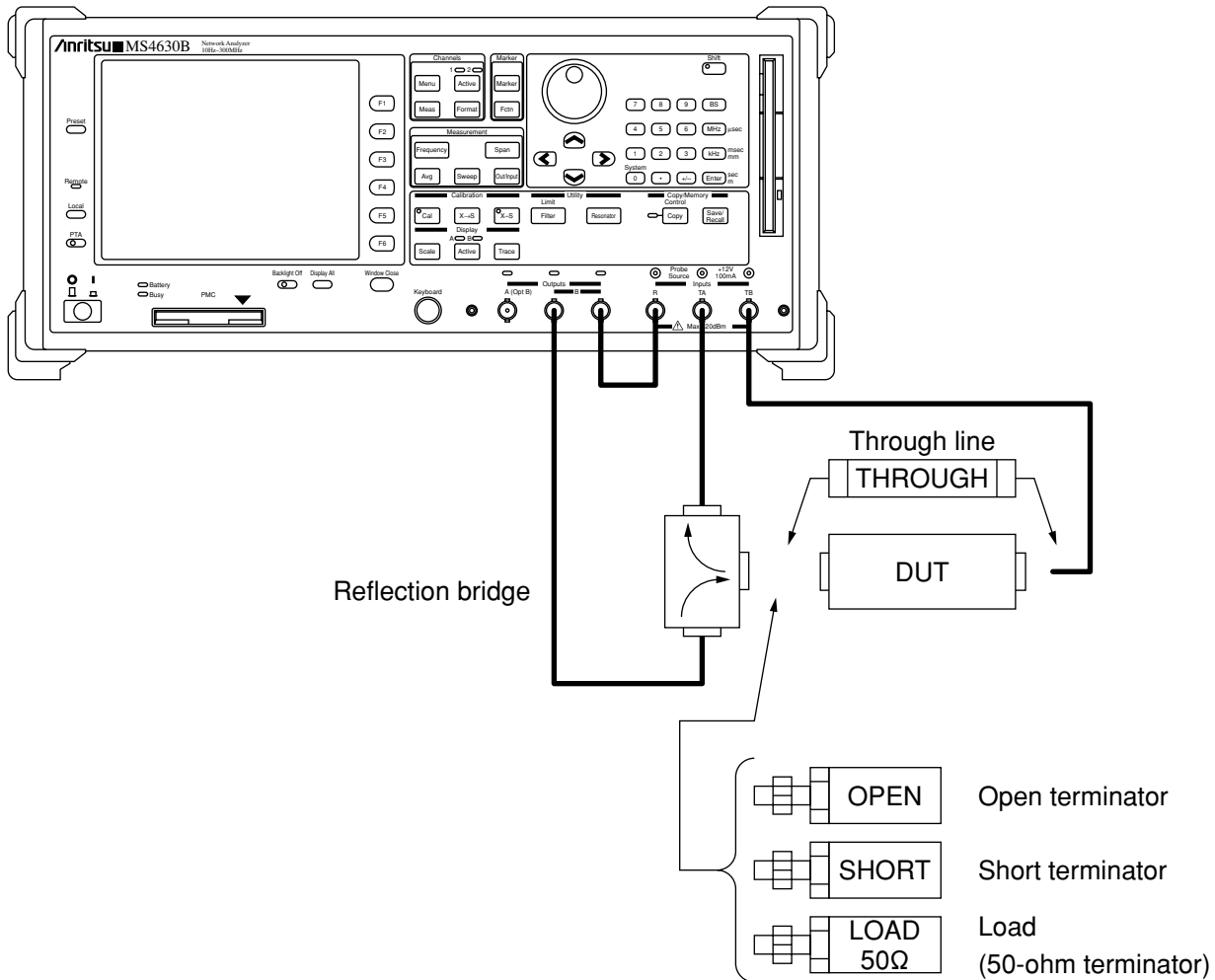

12.5 Measuring Transfer and Reflection Characteristics Simultaneously (Option 12)

(2) Measurement procedure

Step	Description of operation
1	Configure a measuring system to which a DUT (device under test) is connected, according to the Setup Drawing.
2	Press Menu in the Channel group, then press CH1 & CH2 .
3	Make sure the CH1-side lamp on the Active key is lit (CH1 is active), press the Meas key in the Channels group, then press TA/R . When the CH2-side lamp is lit, press Active to turn on the CH1-side lamp.
4	Press Active to turn on the CH2-side lamp (to activate CH2), press Meas , then press TB/R .
5	Press Trace in the Display group, then press SPLIT DISP .
6	Using the keys in the Measurement group and soft keys, set the following parameters: CENTER: 90 MHz SPAN: 100 kHz RBW: 1 kHz
7	Press Cal , then press setup . Select CAL METHOD from the CALIBRATION window, then press the Enter key.
8	Select 1PATH 2PORT from the CAL METHOD window, then press the Enter key.
9	Press Active in the Channels group to activate CH1.
10	Disconnect the DUT from the measuring system and connect an open terminator. Press Cal , then press the OPEN -default- soft key. A sweep is performed to obtain CAL data, then the OPEN -default- soft key changes to the OPEN -created- soft key.
11	Connect a short terminator and press SHORT -default- .
12	Connect a load (50-Ω terminator) and press LOAD -default- .
13	Press Active in the Channels group to activate CH2. Disconnect the DUT, connect a through line, and press THRU -default- .
14	Press the CAL ON soft key, press Active , then press CAL ON (for both CH1 and CH2). The calibration function is turned on.
15	Disconnect the through line and reconnect the DUT.

Section 12 Measurements

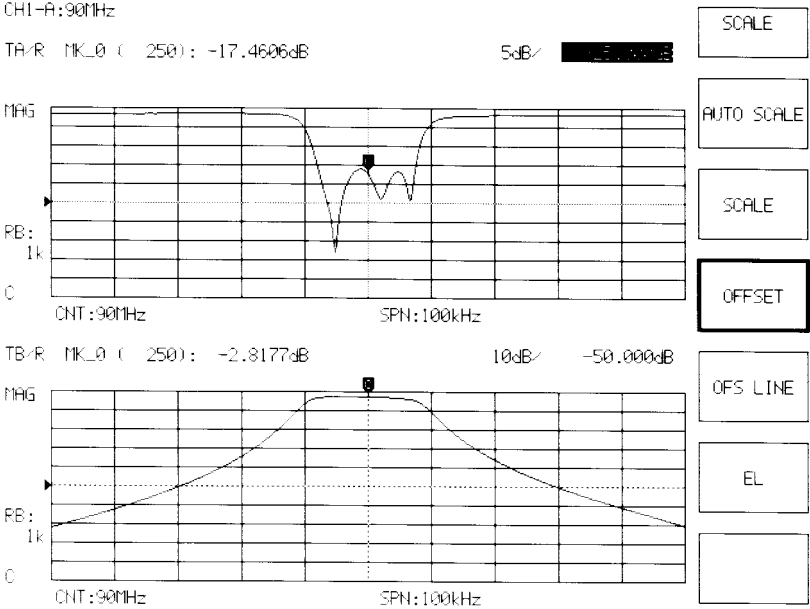
Step	Description of operation
16	<p>Press the <input type="button" value="Scale"/> key in the Display section. Using soft keys, adjust the scale and offset so that the trace waveform is displayed at the optimum position on the screen.</p> 

NOTE:

To use the 1PATH 2PORT calibration method, be sure to perform the following operations:

- Select CH1 & CH2 (dual channel measurement) as measurement channels and set on “COUPLED CHANNEL.”
- Select TA/R as the CH1-side analysis port to measure the reflection characteristic.
- Select TB/R as the CH2-side analysis port to measure the transfer characteristic.
- To obtain OPEN, SHORT, or LOAD calibration data, select CH1 as the active channel. To obtain THROUGH calibration data, select CH2 as the active channel.
- Select CAL ON (calibration start) for individual channels.
- Select CAL ON both CH1 and CH2.

12.6 Measuring a Filter

You can measure a filter using the filter analysis function, a feature of this system.
Measure a 90-MHz band pass filter to analyze the following:

- Bandwidth at a 3 dB down point from 90 MHz
- Bandwidth at a 40 dB down point from 90 MHz
- Insertion loss at 90 MHz
- Center frequency of filter
- Q value
- Shape factor

(1) Setup

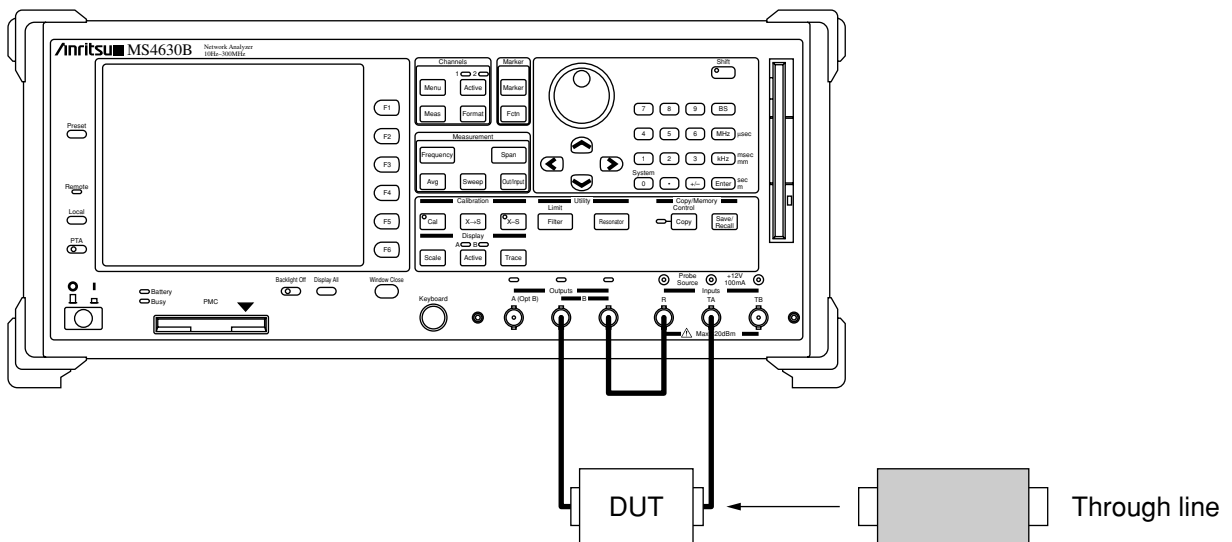

(2) Measurement procedure

Step	Description of operation
1	Configure a measuring system to which a DUT (device under test) is connected, according to the Setup Drawing.
2	Using the keys in the Measurement group and soft keys, set the following parameters: CENTER: 90 MHz SPAN: 100 kHz RBW: 1 kHz
3	Disconnect the DUT from the measuring system and connect a through line. Press Cal , then press the RESPONSE -default- soft key. A sweep is performed to obtain CAL data, then the RESPONSE -default- soft key changes to the RESPONSE -created- soft key.

Section 12 Measurements

Step	Description of operation
4	Press the CAL ON soft key. The calibration function is turned on.
5	Disconnect the through line and reconnect the DUT.
6	Press Limit in the Utility group, then press setup .
7	In the FILTER ANALYSIS window, set the following parameters: FILTER CF: 90 MHz REF for IL CALC: FILTER CF BW REF: FILTER CF X1dB DOWN: 3 dB X2dB DOWN: 40 dB RPL SEARCH START: 89.995 MHz RPL SEARCH END: 90.005 MHz RPL RESOLUTION: 0.020 dB FREQ DISP DIGITS: 6
8	Press ANALYSIS ON/OFF to set it on.

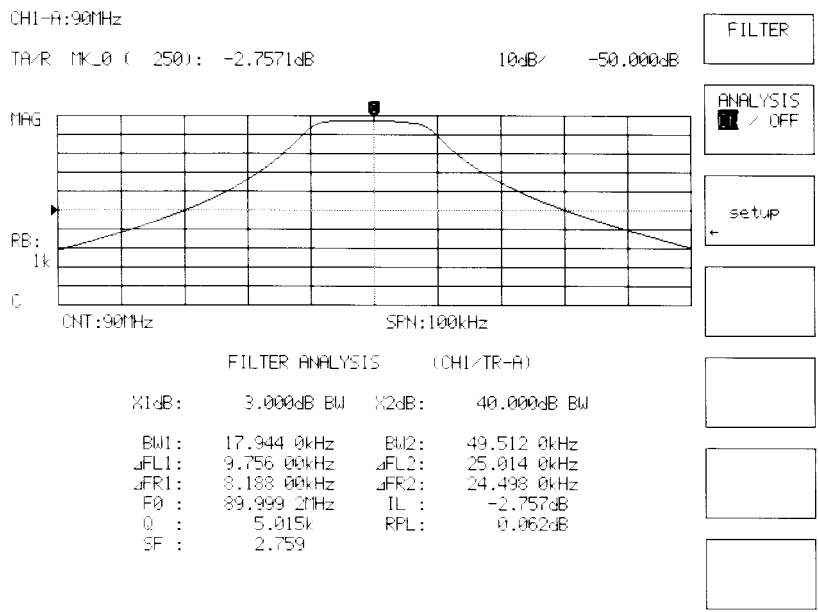

12.7 Measuring a Resonator

You can measure a resonator using the resonator analysis function, a feature of this system.

Using a pi network jig whose measurement terminal impedance is 12.5Ω , measure a 20 MHz crystal resonator to analyze the following:





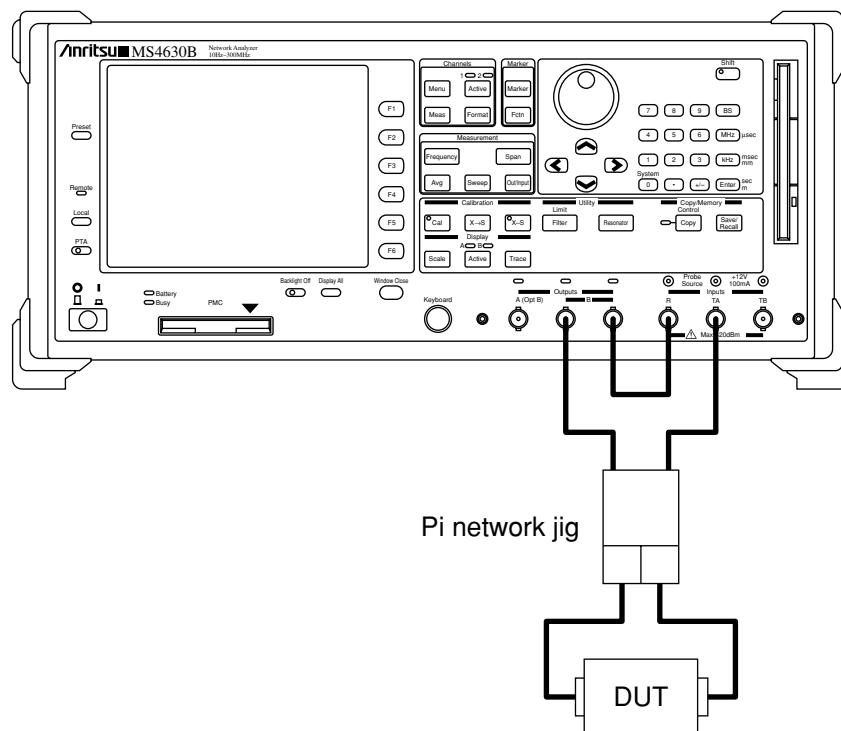







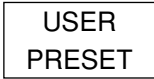

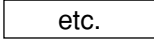
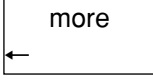

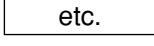
- Resonance frequency and impedance (F_r , Z_r)
- Antiresonance frequency and impedance (F_a , Z_a)
- Series resonance frequency (F_s)
- Four-element equivalent circuit (R_1 , C_1 , L_1 , C_0)
- Q

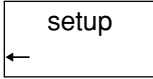
(1) Setup

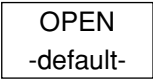
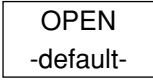
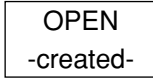

Section 12 Measurements

(2) Measurement procedure

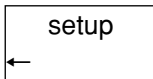
Step	Description of operation
1	Press  , then press  (SYSTEM). Press  to display the USER PRESET window, then select TRANSFER (transfer method) for IMPD MEASUREMENT.
NOTE: The contents of SYSTEM do not change if presetting is performed.	
2	Configure a measuring system to which a DUT (device under test) is connected, according to the Setup Drawing.
3	Press  in the Channels group. Press the  soft key once, then press  to open the FORMAT window. Select <LOG Z & θ > for FORMAT, then press the  key.
4	Press  in the Measurement group. Press  once to set REFERENCE IMPEDANCE to 12.5 Ω .
5	Using the keys in the Measurement group and soft keys, set the following parameters: CENTER: 20 MHz SPAN: 100 kHz RBW: 300 kHz POWER: 0 dBm
6	Press  , then press  . Select CAL METHOD from the CALIBRATION window, then press  .
7	Select PI NET from the CAL METHOD window, then press  .
8	Disconnect the DUT from the pi network and press  . A sweep is performed to obtain CAL data, then the  soft key changes to the  soft key.
9	Connect a jumper pin (0 Ω) to the pi network and press  . A sweep is performed and then the  soft key changes to the  soft key.
10	Press the  soft key. The calibration function is turned on.
11	Disconnect the jumper pin and reconnect the DUT.
12	Press  in the Utility group, then press  .

12.7 Measuring a Resonator

Step	Description of operation
13	In the RESONATOR ANALYSIS window, set the following parameters: START FREQ: 19.95 MHz ENDFREQ: 20.05 MHz FREQ DISP DIGITS: 8
14	Press RESON2 .
15	Press ANALYSIS ON/OFF to set it on.

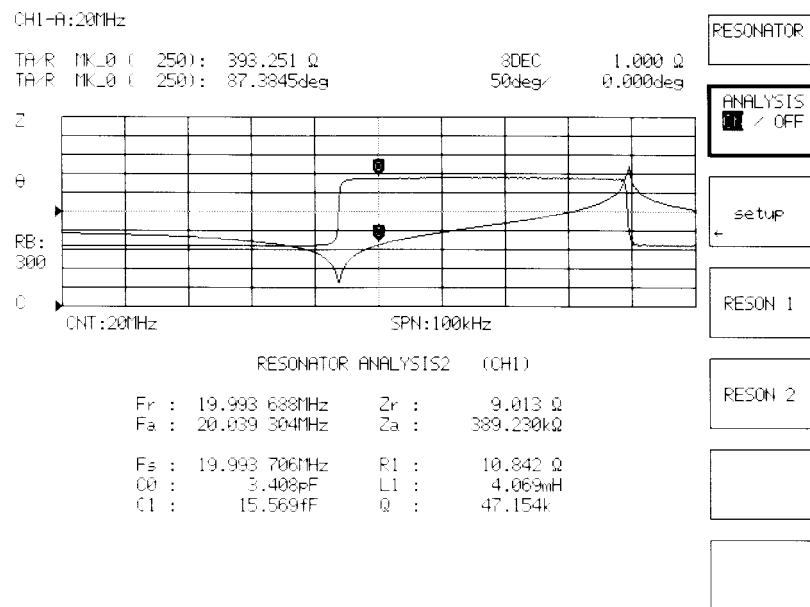

Section 12 Measurements

Section 13 Performance Tests

This section explains the measuring devices, setup, and procedures for performing performance tests.

13.1	Cases where Performance Tests are Required	13-2
13.2	List of Measuring Devices Used for Performance Tests	13-3
13.3	Performance Test	13-4
13.3.1	Reference resonator frequency stability	13-4
13.3.2	Transmitter circuit characteristic: Output frequency	13-6
13.3.3	Transmitter circuit characteristic: Output level accuracy	13-7
13.3.4	Transmitter circuit characteristic: Output level linearity	13-8
13.3.5	Transmitter circuit characteristic: Output level deviation	13-9
13.3.6	Transmitter circuit characteristic: Output level step error (option 10)	13-11
13.3.7	Receiver circuit characteristic: Average noise level	13-12
13.3.8	Receiver circuit characteristic: Cross talk	13-13
13.3.9	Receiver circuit characteristic: Magnitude dynamic accuracy	13-15
13.3.10	Receiver circuit characteristic: Phase dynamic accuracy	13-17

Section 13 Performance Tests

13.1 Cases where Performance Tests are Required

Performance tests are performed, as part of the preventive maintenance, to prevent the system performance from being impaired.

Performance tests must be performed after acceptance inspection, periodic inspection, or repair.

After acceptance inspection, periodic inspection, or repair, perform the following performance tests:

- Reference resonator frequency stability
- Transmitter circuit characteristic: Output frequency
- Transmitter circuit characteristic: Output level accuracy
- Transmitter circuit characteristic: Output level linearity
- Transmitter circuit characteristic: Output level deviation
- Transmitter circuit characteristic: Output level step error (option 10)
- Receiver circuit characteristic: Average noise level
- Receiver circuit characteristic: Cross talk
- Receiver circuit characteristic: Magnitude dynamic accuracy
- Receiver circuit characteristic: Phase dynamic accuracy

Performance tests you think important must be periodically conducted as preventive maintenance. The recommended periodic test cycle is 1 year.

If a performance test result indicates any nonconformity to the specifications, contact our Service Department.

13.2 List of Measuring Devices Used for Performance Tests

Measuring device	Required performance *1	Test item	Recommended device
Frequency counter	Frequency range: 10 Hz to 300 MHz Number of display digits: 10 External reference input: 10 MHz can be input.	Reference resonator frequency stability Output frequency	MF1603A
Power meter Power sensor	Main unit accuracy: ± 0.002 dB Frequency range: 100 kHz to 300 MHz (depends on the power sensor type) Frequency range: 100 kHz to 300 MHz Measurement power range: -10 to $+20$ dBm	Output level accuracy Output level linearity Output level deviation Magnitude dynamic accuracy Phase dynamic accuracy	ML4803A MA4601A
Audio analyzer	Measurement power range: -10 to $+20$ dBm Frequency range: 10 Hz to 100 kHz	Output level deviation	
Standard attenuator	Attenuator having calibration accuracy traced to domestic standard (10 dB/0.01 dB)	Magnitude dynamic accuracy Phase dynamic accuracy	
Frequency standard	Frequency: 10 MHz Stability: 1×10^{-9} or less	Reference resonator frequency stability	

NOTE:

Some of performance requirements to check for the specified test items are listed.

Section 13 Performance Tests

13.3 Performance Test

Before conducting a performance test, warm up the DUT and measuring devices for at least 30 minutes unless otherwise specified. To obtain the most accurate result, the test must be conducted at room temperature, the AC supply voltage must not fluctuate greatly, and there must be no problem associated with noise, vibration, dust, and moisture.

It is recommended that the performance test result be entered in the Performance Test Result Form shown in Appendix A.

13.3.1 Reference resonator frequency stability

Test the internal reference resonator for frequency stability.

Measure the frequency change (aging rate) after power-on and the temperature change (temperature stability) relative to the ambient temperature.

(1) Test standards

■ Reference resonator

- Output frequency: 10 MHz
<Standard>
- Aging rate: $\pm 1 \times 10^{-6}$ /day or less (15 minutes after power-on)
- Temperature characteristic:
 $\pm 5 \times 10^{-6}$ or less (0 to 50 °C)
<Option13>
- Aging rate: $\pm 2 \times 10^{-8}$ /day or less (24 hours after power-on)
- Temperature characteristic:
 $\pm 5 \times 10^{-8}$ /day or less (0 to 50 °C)

(2) Measuring devices

- Frequency counter
- Frequency standard: $\pm 1 \times 10^{-9}$ /day or less

(3) Setup

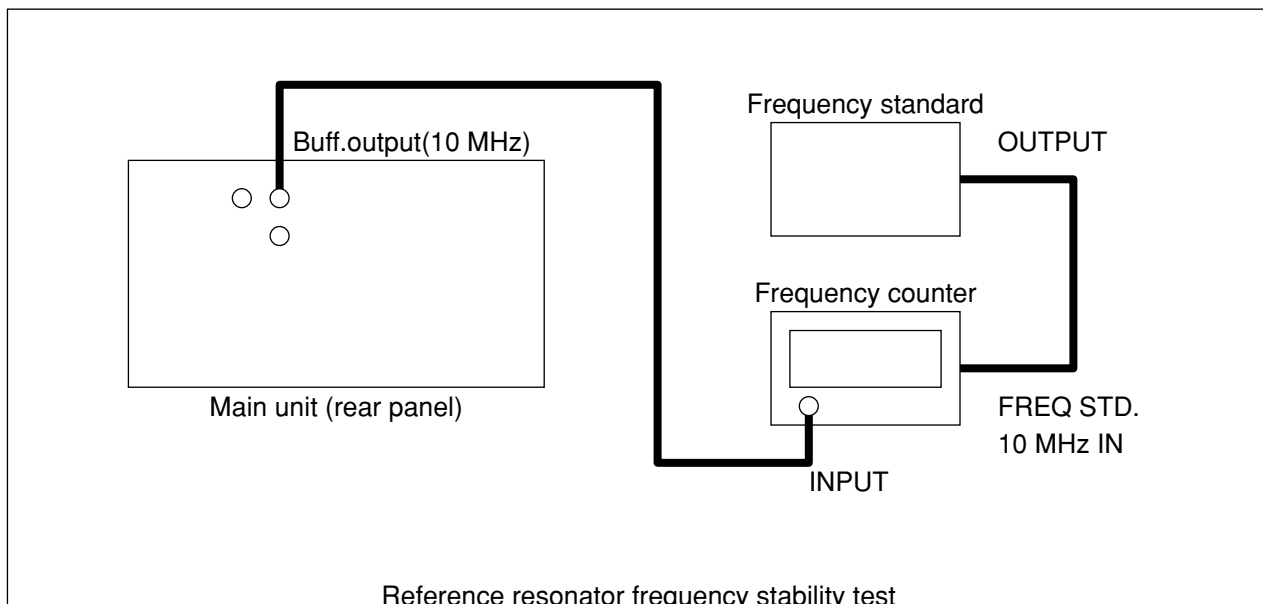

(4) Test procedure

Aging rate: This measurement must be performed in a place where the ambient temperature is 23 ± 3 °C and there is no vibration.

Step	Description of operation
1	Turn on the DUT.
2	Measure frequency using a frequency counter 15 minutes (standard) or 24 hours (option 13) after power-on.
3	Measure frequency using a frequency counter 24 hours after the above measurement.
4	Calculate the aging rate from: Aging rate = $\{(\text{Second measured value}) - (\text{First measured value})\} / (\text{First measured value})$

Temperature characteristic: This measurement must be performed using a vibration-free thermostatic oven.

Step	Description of operation
1	Place only the DUT in the thermostatic oven and keep the temperature in the oven at 25 °C.
2	Turn on the DUT and wait until its internal temperature becomes stable (about 1.5 hours after the temperature in the oven becomes constant).
3	Measure frequency using a frequency counter.
4	Set the oven temperature to 50 °C.
5	When the oven temperature and the internal temperature of the DUT become stable, measure frequency using a frequency counter.
6	Calculate the temperature characteristic from the following equation: Temperature characteristic = $\{(\text{Value measured at } 50 \text{ °C}) - (\text{Value measured at } 25 \text{ °C})\} / (\text{Value measured at } 25 \text{ °C})$
7	Set the oven temperature to 0 °C and repeat steps 5 and 6.

(5) Note

The reading of the frequency counter may include an error of ± 1 count.

Section 13 Performance Tests

13.3.2 Transmitter circuit characteristic: Output frequency

The network analyzer supplies the same synthesizer local signals to the input and output circuits to measure the output frequency interlocked with the input frequency. The input frequency can be obtained by measuring the output frequency.

(1) Test standard

- Output frequency range: 10 Hz to 300 MHz (0.01-Hz resolution)

(2) Measuring device

- Frequency counter

(3) Setup

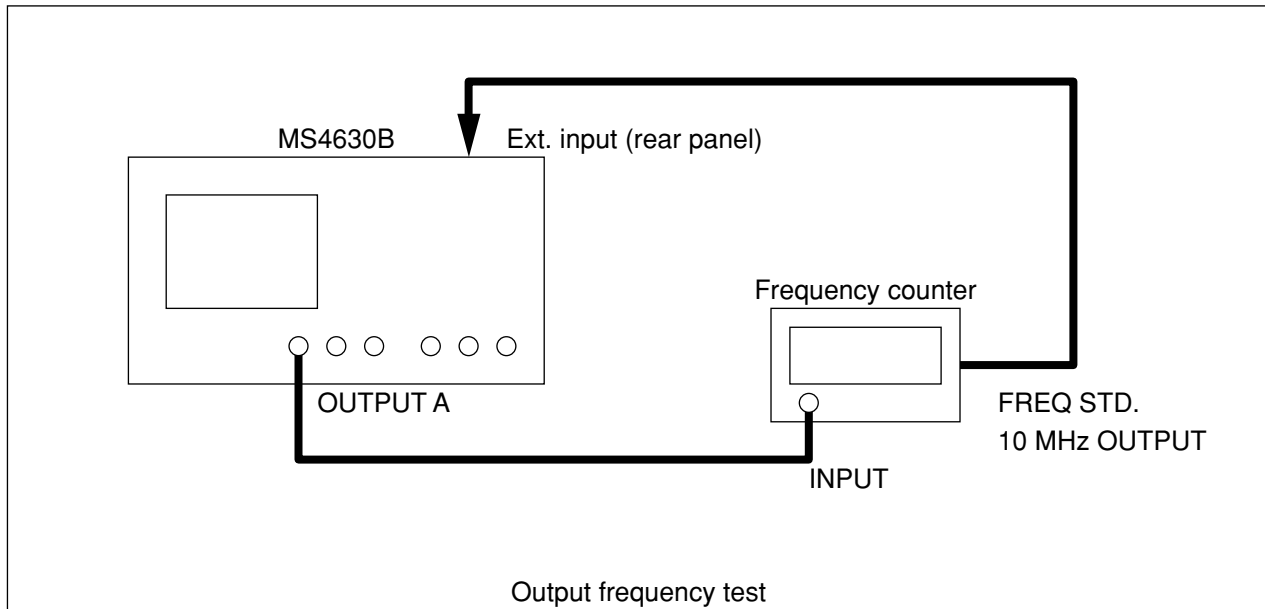

(4) Test procedure

Step	Description of operation
1	Set the span to 0 Hz, output port to port A, and output level to +6 dBm.
2	Set the center frequency to a desired value.
3	Make sure that the reading of the frequency counter equals the set value.
4	Perform measurements by changing the center frequency.

(5) Note

The reading of the frequency counter may include an error of ± 1 count.

13.3.3 Transmitter circuit characteristic: Output level accuracy

(1) **Test standard**

- Output level accuracy: ± 1 dB or less (100 MHz frequency, A output, at +10 dB)

(2) **Measuring devices**

- Power meter
- Power sensor

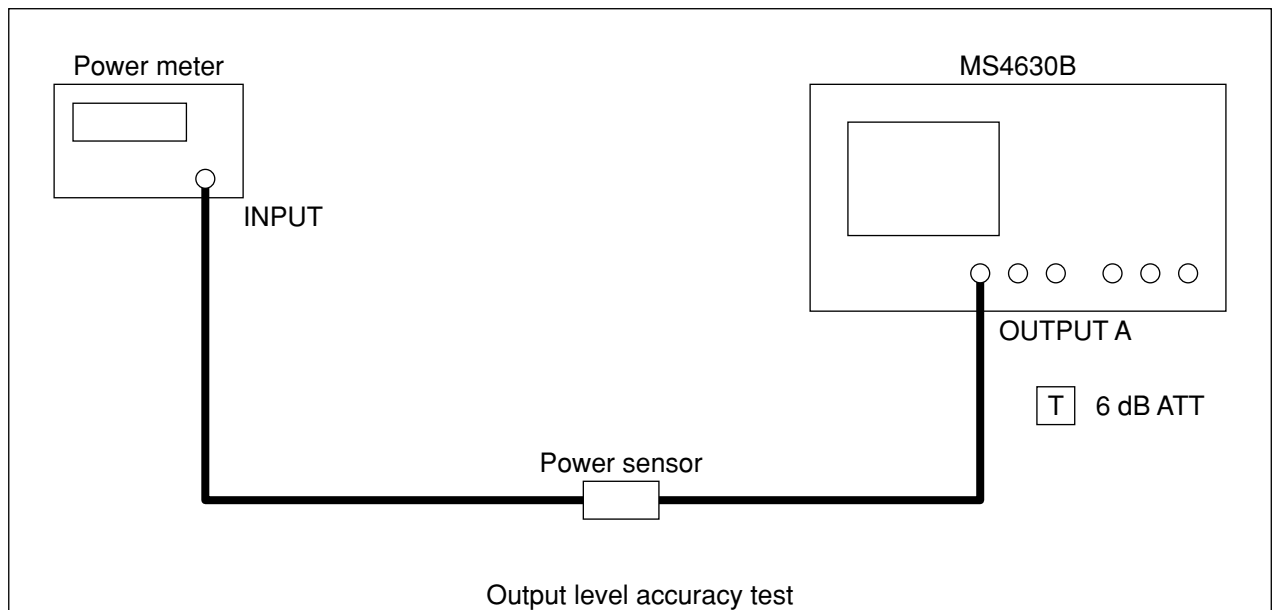

(3) **Setup**

(4) **Test procedure**

Step	Description of operation
1	Zero-adjust the power meter and adjust the sensor sensitivity.
2	Set the center frequency of this system to 100 MHz, span to 0 Hz, output port to port A, and output level to +10 dBm.
3	Set the calibration coefficient of the power meter sensor to read the output level.

Section 13 Performance Tests

13.3.4 Transmitter circuit characteristic: Output level linearity

(1) Test standard

- Output level linearity: ± 0.5 dB or less (A output, 100 MHz frequency, 0 dBm reference, at 0 to +21 dBm)

(2) Measuring devices

- Power meter
- Power sensor

(3) Setup

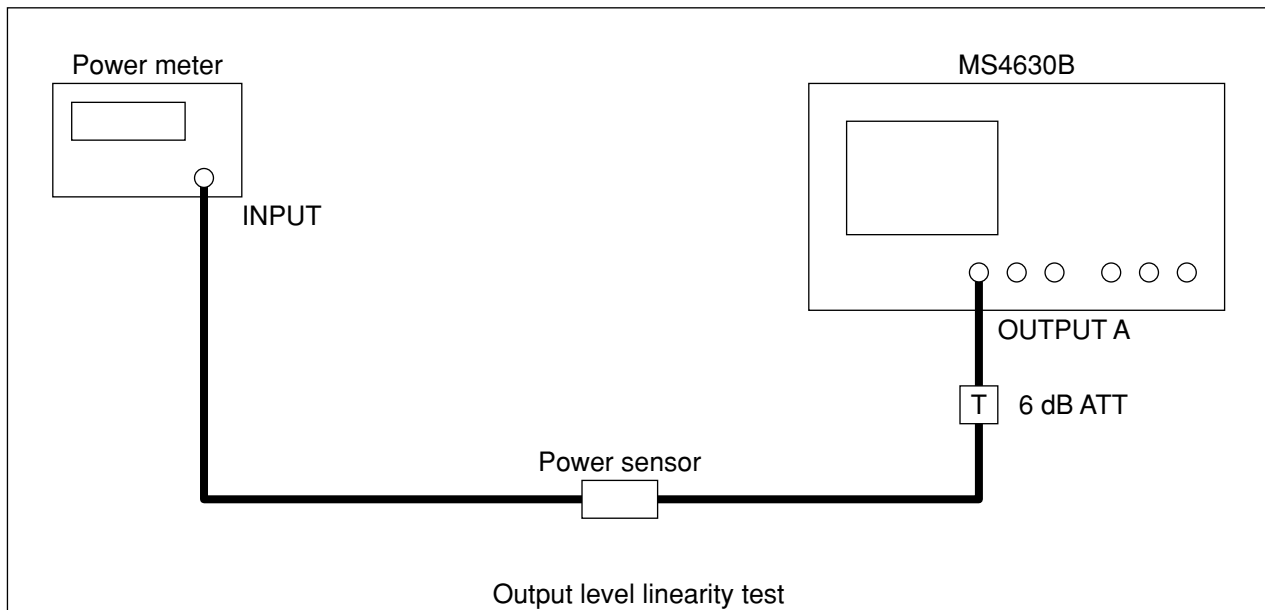

(4) Test procedure

Step	Description of operation
1	Zero-adjust the power meter and adjust the sensor sensitivity.
2	Set the center frequency of this system to 100 MHz, span to 0 Hz, output port to port A, and output level to +10 dBm.
3	Set the calibration coefficient of the power meter sensor to read the output level. The reading becomes the reference value.
4	Set the output level of this system to 0 dBm.
5	Read the output level using a power meter. Find the output level linearity from the following equation: Output level linearity [dB]= (Measured value – Output level setting) – (Value measured at +10 dBm – 10)
6	Measure the output level linearity by increasing the output level of this system up to +21 dBm in increments of 1 dB.

13.3.5 Transmitter circuit characteristic: Output level deviation

(1) **Test standard**

- Output level deviation: ± 1.5 dB or less (A output, at +10 dBm, 100 MHz reference)

(2) **Measuring devices**

- Power meter
- Power sensor
- Audio analyzer

(3) **Setup**

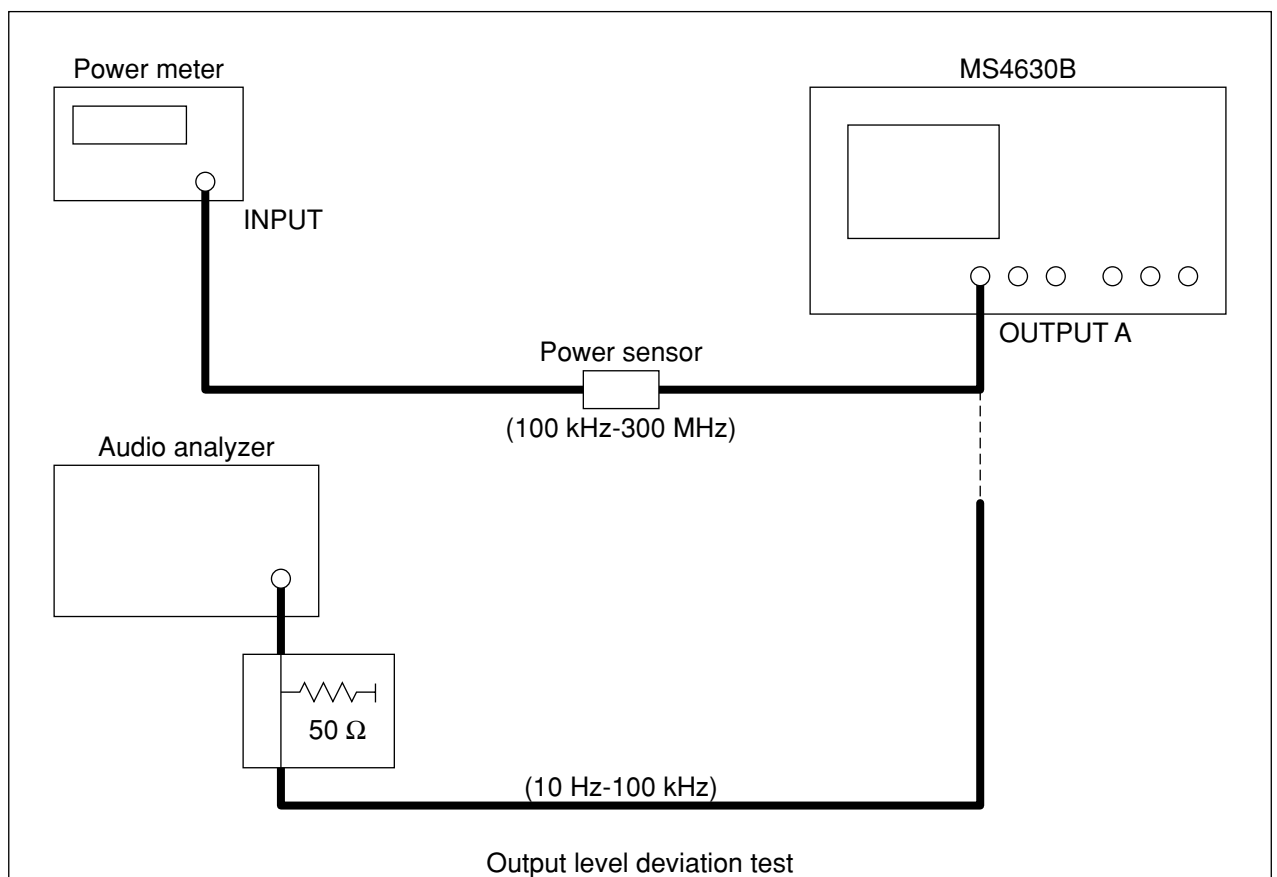

Section 13 Performance Tests

(4) Test procedure

100 kHz to 300 MHz test: This test must be performed using a power meter.

Step	Description of operation
1	Zero-adjust the power meter and adjust the sensor sensitivity.
2	Set the center frequency of this system to 100 MHz, span to 0 Hz, output port to port A, and output level to +10 dBm.
3	Set the calibration coefficient of the power meter sensor to read the output level. The reading becomes the reference value.
4	Set the center frequency of this system to a desired value.
5	Set the calibration coefficient of the power meter sensor and read the output level. Find the output level deviation from the following equation: Output level deviation = (Output level) – (Output level at 100 MHz)
6	Repeat steps 4 and 5 by changing the frequency.

10 kHz to 100 MHz test: This test must be performed using an audio analyzer.

Step	Description of operation
1	Set the span of this system to 0 Hz, output port to port A, and output level to +10 dBm.
2	Set the center frequency of this system to a desired value between 10 Hz and 100 kHz.
3	Using an audio analyzer, measure the output voltage. Find the output level deviation from the following equation: Output level [dBm] = 10*log (Measured value [Vrms] ² /50 [Ω] /0.001 [W])
4	The difference between the above output level and the output level measured at 100 MHz in the “100 kHz to 300 MHz” test gives the output level deviation.
5	Repeat steps 2 to 4 by changing the center frequency of this system.

13.3.6 Transmitter circuit characteristic: Output level step error (option 10)

The output level step error test can be performed only when option 10 is provided.

(1) **Test standard**

- Output level step error: ± 0.5 dB (option 10)

(2) **Measuring device**

None (MS4630B)

(3) **Setup**

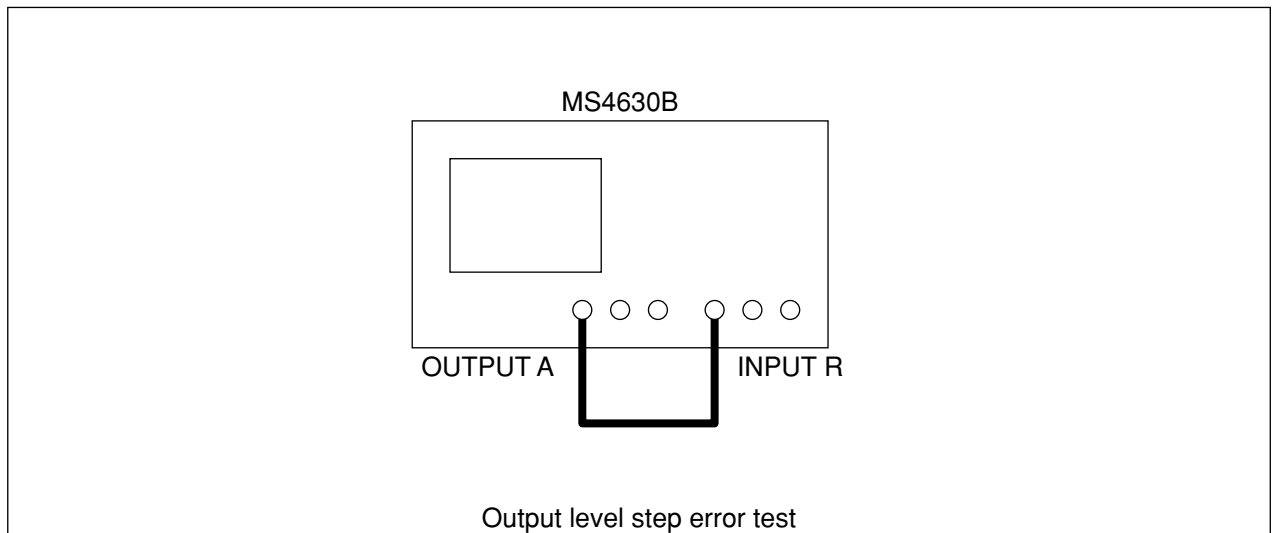

(4) **Test procedure**

Step	Description of operation
1	Set the start frequency of this system to 10 kHz, stop frequency to 300 MHz, level measurement mode to R, RBW to 100 Hz, and output port to port A.
2	Set the output level to 0.00 dBm and execute X-S CAL.
3	Set the output level to -0.01 dBm and measure the maximum deviation of the measurement waveform from 0 dBm. Find the output level step error from the following equation: Output level step error [dB] = Maximum deviation [dB] - 0.01 [dB]
4	Measure the maximum deviations by repeating steps 2 and 3 with the output level changed as follows: -10.00 → -10.01 dBm, -20.00 → -20.01 dBm, ..., -60.00 → -60.01 dBm

Section 13 Performance Tests

13.3.7 Receiver circuit characteristic: Average noise level

(1) Test standard

- Average noise level: ≤ -120 dBm (1 MHz to 300 MHz, RBW: At 1 kHz)
 ≤ -110 dBm (80 kHz to 1 MHz, RBW: At 1 kHz)

(2) Measuring device

None (MS4630B)

(3) Setup

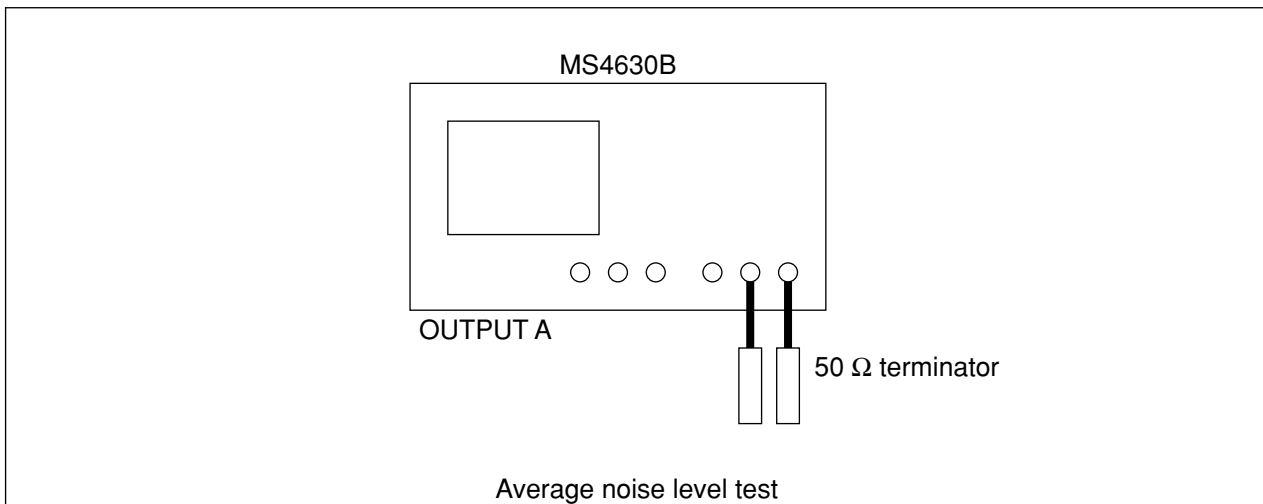

(4) Test procedure

Step	Description of operation
1	Set the span of this system to 0 Hz, level measurement port to TA, RBW to 1 kHz, and smoothing aperture to 50 %, and then terminate the TA with a 50 Ω terminator.
2	Set the center frequency of this system to the target frequency.
3	Read the marker value. The reading becomes the average noise level.
4	Repeat steps 2 and 3 by changing the center frequency.
5	When reception port TB (option 12) is provided, select level measurement port TB and repeat steps 1 to 4.

13.3.8 Receiver circuit characteristic: Cross talk

(1) **Test standard**

- Cross talk:

Between channels:	≥ 120 dB (80 kHz to 300 MHz)
	≥ 110 dB (10 Hz to 80 kHz)
Between transmitter and receiver circuits:	≥ 125 dB

(2) **Measuring device**

None (MS4630B)

(3) **Setup**

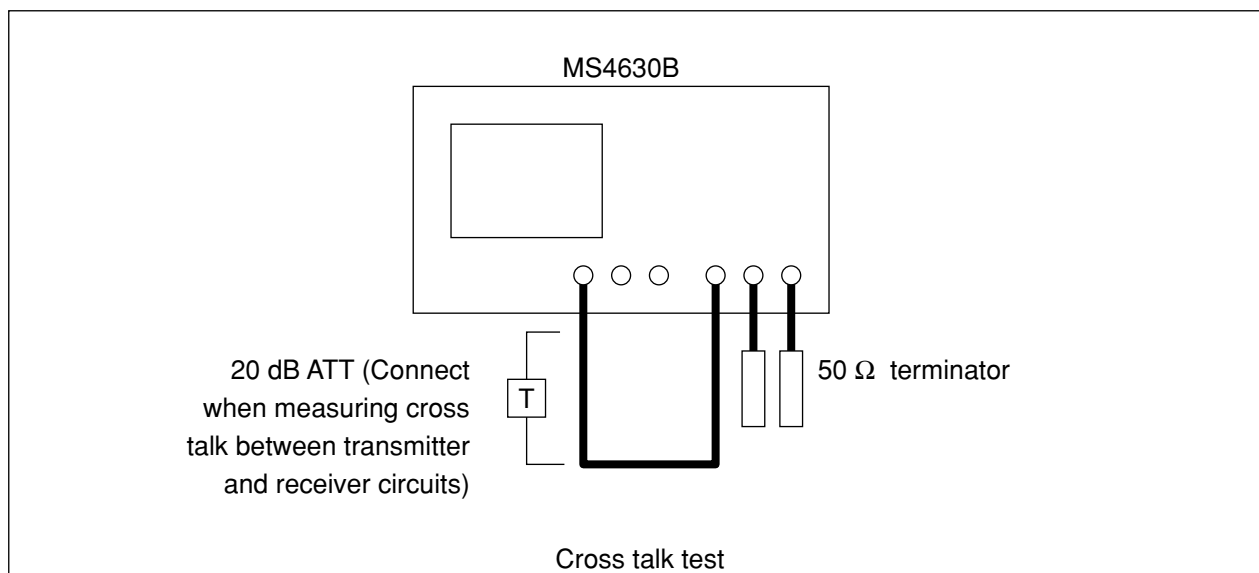

Section 13 Performance Tests

(4) Test procedure

Cross talk between channels

Step	Description of operation
1	Connect output A and R of this system.
2	Set the start frequency of this system to 10 kHz, stop frequency to 300 MHz, RBW to 3 Hz, output port to port A, output level to 0 dBm, and analysis port to TA/R. Set SMOOTHING to 1%.
3	Execute a single sweep and obtain the maximum value by performing the MKR→MAX function. The marker value [dB] multiplied by (-1) gives the cross talk between R and TA.
4	When reception port TB (option 12) is provided, select TB/R and repeat step 3.

Cross talk between transmitter and receiver circuits

Step	Description of operation
1	Connect output A and R of this system via a 20 dB ATT.
2	Set the start frequency of this system to 10 kHz, stop frequency to 300 MHz, RBW to 3 Hz, output port to port A, output level to +20 dBm, and analysis port to TA/R. Set SMOOTHING to 1%.
3	Execute a single sweep and obtain the maximum value by performing the MKR MAX function. The marker value [dB] multiplied by (-1) plus 20 [dB] gives the cross talk between the transmitter and receiver circuits.
4	When reception port TB (option 12) is provided, select TB/R and repeat step 3.

13.3.9 Receiver circuit characteristic: Magnitude dynamic accuracy

(1) Test standards

- Magnitude dynamic accuracy:

Level relative to input range	Frequency	
	80 kHz to 100 MHz	10 kHz to 300 MHz
0 to -10 dB	$\leq \pm 0.20$ dB	$\leq \pm 0.20$ dB
-10 to -60 dB	$\leq \pm 0.05$ dB	$\leq \pm 0.05$ dB
-60 to -70 dB	$\leq \pm 0.10$ dB	$\leq \pm 0.30$ dB
-70 to -80 dB	$\leq \pm 0.30$ dB	$\leq \pm 1.00$ dB
-80 to -90 dB	$\leq \pm 1.20$ dB	$\leq \pm 4.00$ dB
-90 to -100 dB	$\leq \pm 4.00$ dB	–

(2) Measuring device

- Standard attenuator: Attenuator with standard calibration accuracy (10 dB/0.01 dB)

(3) Setup

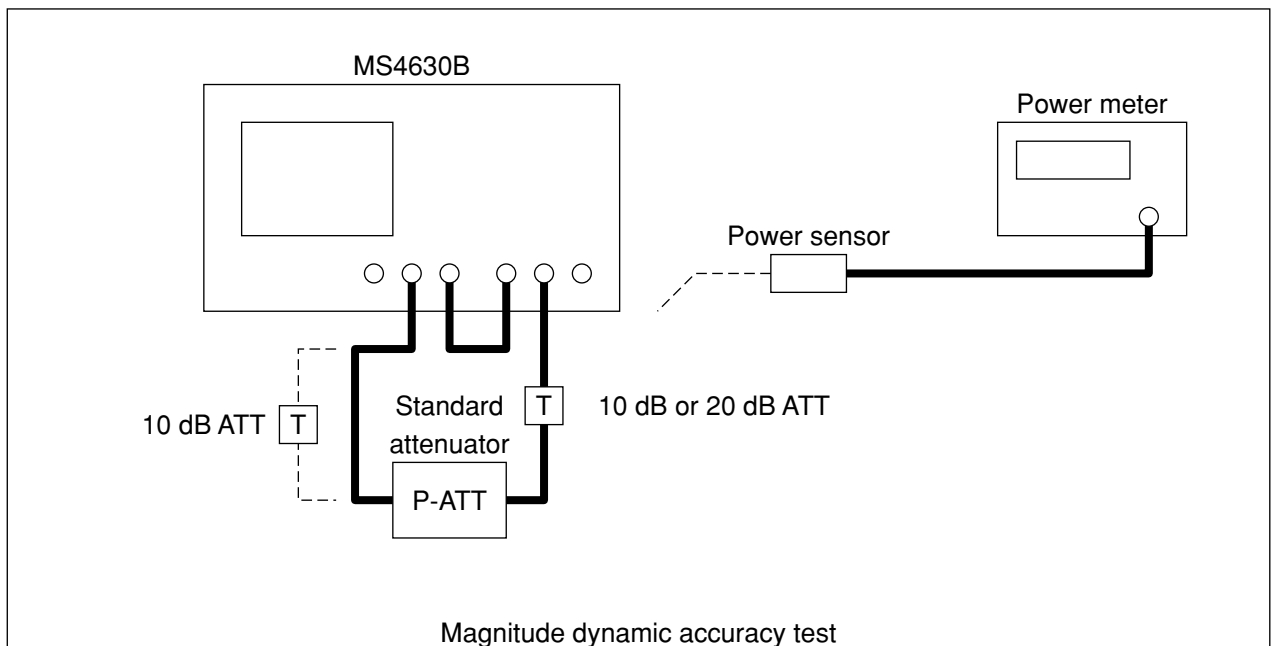

(4) Operation procedure

Step	Description of operation
1	Set the span of this system to 0 Hz, RBW to 30 Hz, output port to B, analysis port to TA/R, R's input range to 20 dBm, TA's input range to 0 dBm, and smoothing aperture to 10 %.
2	Connect the B output and the input side of the standard attenuator and connect the output side of the standard attenuator to the power meter via a 10 dB ATT.
3	Set the center frequency of this system to the target frequency.
4	Set the standard attenuator to 0 dB and adjust the output level so that the power meter reads 0 dBm.

Section 13 Performance Tests

Step	Description of operation
5	Disconnect the power meter, connect it to the TA, and set the standard attenuator to 10 dB.
6	Press “X→S” to perform normalization.
7	Set the standard attenuator to 0 dB.
8	Perform a single sweep to read the marker value. The reading becomes measurement data A0.
9	Set the standard attenuator to 20 dB and 30 dB, and perform step 8 repeatedly to obtain measurement data A20 and A30.

Relationships between measurement data and standards are as follows:

Measurement data	Standard attenuator	Value relative to input range	Standard	
			80 kHz to 100 MHz	10 kHz to 300 MHz
A0	0 dB	0 dB	≤±0.20 dB	≤±0.20 dB
A20	20 dB	20 dB	≤±0.05 dB	≤±0.05 dB
A30	30 dB	30 dB	≤±0.05 dB	≤±0.05 dB

- 10 Replace the reception-side 10 dB ATT with the 20 dB ATT, and connect the transmitter circuit to the standard attenuator via a 10 dB ATT.
- 11 Set the standard attenuator to 10 dB.
- 12 Perform a single sweep to read the marker value.
Calculate K from the following equation:
 $K = (\text{Marker value}) - A30$
- 13 Set the standard attenuator to 20 dB.
- 14 Perform a single sweep to read the marker value.
Find B20 from the following equation:
 $B20 = (\text{Marker value}) - K$
- 15 Set the standard attenuator to 30 dB, 40 dB, 50 dB, 60 dB, 70 dB, and 80 dB, and perform step 14 repeatedly to obtain B30, B40, B50, B60, B70, and B80.

Relationships between measurement data and standards are as follows:

Measurement data	Standard attenuator	Value relative to input range	Standard	
			80 kHz to 100 MHz	10 kHz to 300 MHz
B20	20 dB	40 dB	≤±0.05 dB	≤±0.05 dB
B30	30 dB	50 dB	≤±0.05 dB	≤±0.05 dB
B40	40 dB	60 dB	≤±0.05 dB	≤±0.05 dB
B50	50 dB	70 dB	≤±0.10 dB	≤±0.30 dB
B60	60 dB	80 dB	≤±0.30 dB	≤±1.00 dB
B70	70 dB	90 dB	≤±1.20 dB	≤±4.00 dB
B80	80 dB	100 dB	≤±4.00 dB	–

- 16 Repeat steps 2 to 15 by changing the frequency.
- 17 When reception port TB (option 12) is provided, select TB/R and repeat steps 2 to 15.

(5) **Note**

When the measurement frequency is low (100 kHz or lower), the calibration value of the standard attenuator may not match the test result due to a large attenuation quantity of the standard attenuator. To prevent this, insert a 50-ohm 1:1 transformer on the output side of the standard attenuator to separate the ground.

13.3.10 Receiver circuit characteristic: Phase dynamic accuracy

(1) **Test standard**

- Phase dynamic accuracy:

Level relative to input range	Frequency	
	80 kHz to 100 MHz	10 kHz to 300 MHz
0 to -10 dB	$\leq \pm 1.5$ deg	$\leq \pm 1.5$ deg
-10 to -60 dB	$\leq \pm 0.3$ deg	$\leq \pm 0.3$ deg
-60 to -70 dB	$\leq \pm 0.8$ deg	$\leq \pm 2.0$ deg
-70 to -80 dB	$\leq \pm 2.0$ deg	$\leq \pm 6.0$ deg
-80 to -90 dB	$\leq \pm 6.0$ deg	$\leq \pm 20.0$ deg
-90 to -100 dB	$\leq \pm 20.0$ deg	-

(2) **Measuring device**

- Standard attenuator: Attenuator with standard calibration accuracy (10 dB/0.01 dB)

(3) **Setup**

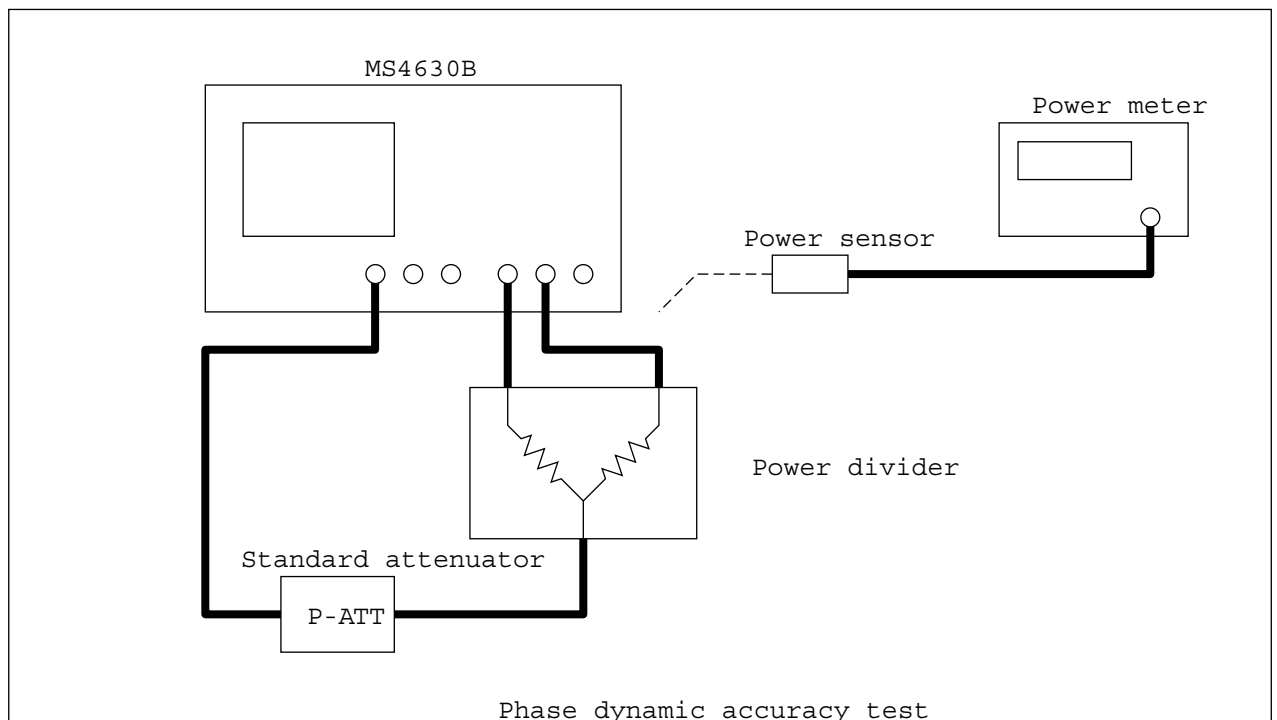

Section 13 Performance Tests

(4) Operation procedure

Step	Description of operation
1	Set the span of this system to 0 Hz, RBW to 30 Hz, output port to A, analysis port to TA/R, analysis format to PHASE, R’s input range to 0 dBm, TA’s input range to 0 dBm, and smoothing aperture to 10 %.
2	Set the center frequency of this system to the target frequency.
3	Connect either output of the power divider to the power meter, set the standard attenuator to 0 dB, and adjust the output level so that the power meter reads 0 dBm.
4	Disconnect the power meter, connect it to the TA, and set the standard attenuator to 10 dB.
5	Press “X→S” to perform normalization.
6	Set the standard attenuator to 0 dB.
7	Perform a single sweep to read the marker value. The reading becomes measurement data P0.
8	Set the standard attenuator to 20 dB, 30 dB, 40 dB, 50 dB, 60 dB, 70 dB, 80 dB, 90 dB, and 100 dB, and perform step 7 repeatedly to obtain measurement data P20, P30, P40, P50, P60, P70, P80, P90, and P100.

Relationships between measurement data and standards are as follows:

Measurement data	Standard attenuator	Value relative to input range	Standard	
			80 kHz to 100 MHz	10 kHz to 300 MHz
P0	0 dB	0 dB	≤±1.5 deg	≤±1.5 deg
P20	20 dB	20 dB	≤±0.3 deg	≤±0.3 deg
P30	30 dB	30 dB	≤±0.3 deg	≤±0.3 deg
P40	40 dB	40 dB	≤±0.3 deg	≤±0.3 deg
P50	50 dB	50 dB	≤±0.3 deg	≤±0.3 deg
P60	60 dB	60 dB	≤±0.3 deg	≤±0.3 deg
P70	70 dB	70 dB	≤±0.8 deg	≤±2.0 deg
P80	80 dB	80 dB	≤±2.0 deg	≤±6.0 deg
P90	90 dB	90 dB	≤±6.0 deg	≤±20.0 deg
P100	100 dB	100 dB	≤±20.0 deg	–

- 9 Repeat steps 2 to 8 by changing the frequency.
- 10 When reception port TB (option 12) is provided, select TB/R and repeat steps 2 to 8.

(5) Note

When the measurement frequency is low (100 kHz or lower), the calibration value of the standard attenuator may not match the test result due to a large attenuation quantity of the standard attenuator. To prevent this, insert a 50-ohm 1:1 transformer on the output side of the standard attenuator to separate the ground.

Section 14 Maintenance

This section explains daily maintenance, long-period storage, repackaging, and transportation.

14.1	Cleaning the Cabinet	14-2
14.2	Notes on Storage	14-3
14.2.1	Precautions for storage	14-3
14.2.2	Recommended storage conditions	14-3
14.3	Repackaging and transporting the System to Return	14-4
14.3.1	Repackaging	14-4
14.3.2	Transportation	14-4

Section 14 Maintenance

14.1 Cleaning the Cabinet

Before cleaning the cabinet, be sure to turn off the POWER switch and unplug the power cord from the wall outlet. Clean the cabinet in the following manner:

- Wipe the cabinet with a dry, soft cloth.
- If the cabinet is severely stained, the system has been used in a dusty place, or the system is to be stored for a long period, wipe the cabinet with a soft cloth damped with synthetic detergent. Next, wipe it with a dry, soft cloth.
- If you find loose parts, secure them tightly using specified tools.

CAUTION

**Do not use benzine, thinner, and alcohol to clean the cabinet.
If used, the paint could be damaged or the cabinet could be discolored or de-
formed.**

14.2 Notes on Storage

This section gives notes on storing the system for a long period or time.

14.2.1 Precautions for storage

- (1) Remove dust, fingerprints, and other stains.
- (2) Do not store the system in the following places:
 - (a) Place exposed to direct sunlight or dusty place
 - (b) Humid place where condensation occurs
 - (c) Place exposed to active gas or acid
 - (d) Place where the following temperature and humidity ranges are exceeded:
 - Temperature: Higher than 60 °C or lower than -20 °C
 - Humidity: 90 % or higher

14.2.2 Recommended storage conditions

When the system is stored for a long period, the following environmental conditions must also be satisfied in addition to the conditions in Section 14.2.1 above:

- Temperature: 0 to 30 °C
- Humidity: 40 to 80 %
- The temperature and humidity must not vary greatly within a day.

Section 14 Maintenance

14.3 Repackaging and transporting the System to Return

When returning the system to Anritsu for repair, follow the precautions given below.

14.3.1 Repackaging

Use the original packing material. To use other packing material, observe the following precautions:

- (1) Wrap the system with a plastic bag or sheet.
- (2) Get a corrugated cardboard box, crate, or aluminum box which is large enough to put cushioning material around the system.
- (3) Put the system in the box along with cushioning material so that it does not move in the box.
- (4) Close the box securely with packing string, adhesive tape, or bands.

14.3.2 Transportation

When transporting the system, avoid vibration as much as possible and satisfy the storage conditions given in Section 14.2.2.

Appendixes

Appendix A	Performance Test Result Form	A-1
Appendix B	List of Defaults	B-1
Appendix C	List of Controls and Connectors on Front and Rear Panels	C-1
Appendix D	List of Error Message	D-1
Appendix E	Example of Settings for Video Plotter VP1500 II (Manufactured by SEIKOSYA)	E-1

Appendixes

Appendix A Performance Test Result Form

Before performing a performance test, copy the form shown here. After completion of the performance test, enter the result in the form.

Appendix A Performance Test Result Form

Test place: _____

Report No. _____
 Date _____
 Person in charge _____

System name: MS4630B network analyzer

Serial No. _____ Ambient temperature _____ °C

Supply frequency _____ Hz

Relative humidity _____ %

Supply voltage _____ V

Remarks:

Reference resonator frequency stability

Aging rate

Frequency measured 15 minutes or 24 hours (option 13) after power-	Frequency measured 24 hours later	Aging rage	Maximum value
_____ [MHz]	_____ [MHz]	_____ [ppm]	±1×10 ⁻⁶ /Day ±2×10 ⁻⁸ /Day (option 13)

Temperature characteristics

Outside temperature	Frequency	Temperature characteristic	Maximum value
0°C	_____ [MHz]	_____ [ppm]	±5×10 ⁻⁶ /Day
25°C	_____ [MHz]	Reference	±5×10 ⁻⁸ /Day
50°C	_____ [MHz]	_____ [ppm]	(option 13)

Transmitter circuit characteristic: Output frequency (15.3.2)

Setting	Result
1 kHz	_____
10 kHz	_____
100 kHz	_____
1 MHz	_____
10 MHz	_____
100 MHz	_____
150 MHz	_____
200 MHz	_____
250 MHz	_____
300 MHz	_____

Transmitter circuit characteristic: Output level accuracy (15.3.3)

Setting		Minimum value	Result	Maximum value
Frequency	Output level			
100 MHz	+10 dBm	-0.5 dB	_____	+0.5 dB

Performance Test Result Form

Transmitter circuit characteristic: Output level linearity (15.3.4)

Setting		Minimum value	Result	Maximum value
Frequency	Output level			
100 MHz	+21 dBm	-0.5 dB	_____	+0.5 dB
	+20 dBm	-0.5 dB	_____	+0.5 dB
	+19 dBm	-0.5 dB	_____	+0.5 dB
	+18 dBm	-0.5 dB	_____	+0.5 dB
	+17 dBm	-0.5 dB	_____	+0.5 dB
	+16 dBm	-0.5 dB	_____	+0.5 dB
	+15 dBm	-0.5 dB	_____	+0.5 dB
	+14 dBm	-0.5 dB	_____	+0.5 dB
	+13 dBm	-0.5 dB	_____	+0.5 dB
	+12 dBm	-0.5 dB	_____	+0.5 dB
	+11 dBm	-0.5 dB	_____	+0.5 dB
	+10 dBm	-0.5 dB	_____	+0.5 dB
	+9 dBm	-0.5 dB	_____	+0.5 dB
	+8 dBm	-0.5 dB	_____	+0.5 dB
	+7 dBm	-0.5 dB	_____	+0.5 dB
	+6 dBm	-0.5 dB	_____	+0.5 dB
	+5 dBm	-0.5 dB	_____	+0.5 dB
	+4 dBm	-0.5 dB	_____	+0.5 dB
	+3 dBm	-0.5 dB	_____	+0.5 dB
	+2 dBm	-0.5 dB	_____	+0.5 dB
+1 dBm	-0.5 dB	_____	+0.5 dB	
0 dBm	-0.5 dB	_____	+0.5 dB	

Transmitter circuit characteristic: Output level deviation (15.3.5)

Setting		Minimum value	Result	Maximum value	
Frequency	Output level				
10 Hz	+10 dBm	-1.5 dB	_____	+1.5 dB	
100 Hz		-1.5 dB	_____	+1.5 dB	
1 kHz		-1.5 dB	_____	+1.5 dB	
10 kHz		-1.5 dB	_____	+1.5 dB	
100 kHz		-1.5 dB	_____	+1.5 dB	
1 MHz		-1.5 dB	_____	+1.5 dB	
10 MHz		-1.5 dB	_____	+1.5 dB	
50 MHz		-1.5 dB	_____	+1.5 dB	
100 MHz		-1.5 dB	_____	Reference	+1.5 dB
150 MHz		-1.5 dB	_____	_____	+1.5 dB
200 MHz		-1.5 dB	_____	_____	+1.5 dB
250 MHz		-1.5 dB	_____	_____	+1.5 dB
300 MHz		-1.5 dB	_____	_____	+1.5 dB

Appendix A Performance Test Result Form

Transmitter circuit characteristic: Output level step error (option 10) (15.3.6)

Output level	Minimum value	Result	Maximum value
0→-0.01 dBm	-0.5 dB	_____	+0.5 dB
-10→-10.01 dBm	-0.5 dB	_____	+0.5 dB
-20→-20.01 dBm	-0.5 dB	_____	+0.5 dB
-30→-30.01 dBm	-0.5 dB	_____	+0.5 dB
-40→-40.01 dBm	-0.5 dB	_____	+0.5 dB
-50→-50.01 dBm	-0.5 dB	_____	+0.5 dB
-60→-60.01 dBm	-0.5 dB	_____	+0.5 dB

Receiver circuit characteristic: Average noise level (15.3.7)

Reception port	Frequency	Result	Maximum value
TA	81 kHz	_____	-110 dB
	990 kHz	_____	-110 dB
	1.1 MHz	_____	-120 dB
	10.1 MHz	_____	-120 dB
	99 MHz	_____	-120 dB
	199 MHz	_____	-120 dB
	299 MHz	_____	-120 dB
TB (option12)	81 kHz	_____	-110 dB
	990 kHz	_____	-110 dB
	1.1 MHz	_____	-120 dB
	10.1 MHz	_____	-120 dB
	99 MHz	_____	-120 dB
	199 MHz	_____	-120 dB
	299 MHz	_____	-120 dB

Receiver circuit characteristic: Cross talk (15.3.8)

Between channels

Reception port	Minimum value	Result
TA	120 dB	_____
TB (option12)	120 dB	_____

Between transmitter and receiver circuits

Reception port	Minimum value	Result
TA	120 dB	_____
TB (option 12)	120 dB	_____

Performance Test Result Form

Receiver circuit characteristic: Magnitude dynamic accuracy (15.3.9)

Setting		Minimum value	Result	Maximum value
Frequency	Value relative to input level			
10.1 kHz	0 dB	-0.20 dB	_____	0.20 dB
	-20 dB	-0.05 dB	_____	0.05 dB
	-30 dB	-0.05 dB	_____	0.05 dB
	-40 dB	-0.05 dB	_____	0.05 dB
	-50 dB	-0.05 dB	_____	0.05 dB
	-60 dB	-0.05 dB	_____	0.05 dB
	-70 dB	-0.30 dB	_____	0.30 dB
	-80 dB	-1.00 dB	_____	1.00 dB
	-90 dB	-4.00 dB	_____	4.00 dB
	-100 dB	-	_____	-
81 kHz	0 dB	-0.20 dB	_____	0.20 dB
	-20 dB	-0.05 dB	_____	0.05 dB
	-30 dB	-0.05 dB	_____	0.05 dB
	-40 dB	-0.05 dB	_____	0.05 dB
	-50 dB	-0.05 dB	_____	0.05 dB
	-60 dB	-0.05 dB	_____	0.05 dB
	-70 dB	-0.10 dB	_____	0.10 dB
	-80 dB	-0.30 dB	_____	0.30 dB
	-90 dB	-1.20 dB	_____	1.20 dB
	-100 dB	-4.00 dB	_____	4.00 dB
99 MHz	0 dB	-0.20 dB	_____	0.20 dB
	-20 dB	-0.05 dB	_____	0.05 dB
	-30 dB	-0.05 dB	_____	0.05 dB
	-40 dB	-0.05 dB	_____	0.05 dB
	-50 dB	-0.05 dB	_____	0.05 dB
	-60 dB	-0.05 dB	_____	0.05 dB
	-70 dB	-0.10 dB	_____	0.10 dB
	-80 dB	-0.30 dB	_____	0.30 dB
	-90 dB	-1.20 dB	_____	1.20 dB
	-100 dB	-4.00 dB	_____	4.00 dB
299 MHz	0 dB	-0.20 dB	_____	0.20 dB
	-20 dB	-0.05 dB	_____	0.05 dB
	-30 dB	-0.05 dB	_____	0.05 dB
	-40 dB	-0.05 dB	_____	0.05 dB
	-50 dB	-0.05 dB	_____	0.05 dB
	-60 dB	-0.05 dB	_____	0.05 dB
	-70 dB	-0.30 dB	_____	-0.30 dB
	-80 dB	-1.00 dB	_____	-1.00 dB
	-90 dB	-4.00 dB	_____	-4.00 dB
	-100 dB	-	_____	-

Appendix A Performance Test Result Form

Receiver circuit characteristic: Phase dynamic accuracy (15.3.10)

Setting		Minimum value	Result	Maximum value
Frequency	Value relative to input level			
10.1 kHz	0 dB	-1.5 deg	_____	1.5 deg
	-20 dB	-0.3 deg	_____	0.3 deg
	-30 dB	-0.3 deg	_____	0.3 deg
	-40 dB	-0.3 deg	_____	0.3 deg
	-50 dB	-0.3 deg	_____	0.3 deg
	-60 dB	-0.3 deg	_____	0.3 deg
	-70 dB	-2.0 deg	_____	2.0 deg
	-80 dB	-6.0 deg	_____	6.0 deg
	-90 dB	-20.0 deg	_____	20.0 deg
	-100 dB	-	_____	-
81 kHz	0 dB	-1.5 deg	_____	1.5 deg
	-20 dB	-0.3 deg	_____	0.3 deg
	-30 dB	-0.3 deg	_____	0.3 deg
	-40 dB	-0.3 deg	_____	0.3 deg
	-50 dB	-0.3 deg	_____	0.3 deg
	-60 dB	-0.3 deg	_____	0.3 deg
	-70 dB	-0.8 deg	_____	0.8 deg
	-80 dB	-2.0 deg	_____	2.0 deg
	-90 dB	-6.0 deg	_____	6.0 deg
	-100 dB	-20.0 deg	_____	20.0 deg
99 MHz	0 dB	-1.5 deg	_____	1.5 deg
	-20 dB	-0.3 deg	_____	0.3 deg
	-30 dB	-0.3 deg	_____	0.3 deg
	-40 dB	-0.3 deg	_____	0.3 deg
	-50 dB	-0.3 deg	_____	0.3 deg
	-60 dB	-0.3 deg	_____	0.3 deg
	-70 dB	-0.8 deg	_____	0.8 deg
	-80 dB	-2.0 deg	_____	2.0 deg
	-90 dB	-6.0 deg	_____	6.0 deg
	-100 dB	-20.0 deg	_____	20.0 deg
299 MHz	0 dB	-1.5 deg	_____	1.5 deg
	-20 dB	-0.3 deg	_____	0.3 deg
	-30 dB	-0.3 deg	_____	0.3 deg
	-40 dB	-0.3 deg	_____	0.3 deg
	-50 dB	-0.3 deg	_____	0.3 deg
	-60 dB	-0.3 deg	_____	0.3 deg
	-70 dB	-2.0 deg	_____	2.0 deg
	-80 dB	-6.0 deg	_____	6.0 deg
	-90 dB	-20.0 deg	_____	20.0 deg
	-100 dB	-	_____	-

Appendix B List of Defaults

When channels 1 and 2 or traces A and B have the same default, only one default is written in the “Default” column.

Key group	Master key	Function	Default	
Channels	Menu	Measurement channel	CH1	
		Coupled channel	ON	
	Active	Active channel	CH1	
	Meas	Analysis port	TA/R	
	Format	Analysis format	LOGMAG	
		Impedance marker value	Z∠θ	
		Admittance marker value	Y∠θ	
		Phase offset	0.000 deg	
	measurement	Frequency	Frequency setting mode	Start/Stop
Start frequency			10 kHz	
Center frequency			150 MHz	
LOG start freq.			10 kHz	
Span		Stop frequency	300 MHz	
		Span frequency	100 MHz	
		LOG stop freq.	300 MHz	
Out/input		Output port	Output port	output B
			output power	-6.00 dBm
		Source power	0.00 dBm	
		Output ATT (opt.)	0.00 dB	
		Output offset	0.00 dB	
		Power sweep	OFF	
		Start level	0.00 dBm	
		Stop level	0.00 dBm	
		Step level	0.00 dBm	
		TA range	0 dBm	
		TB range	0 dBm	
		R range	0 dBm	
		TA impedance	50/75 Ω	
		TB impedance	50/75 Ω	
		R impedance	50/75 Ω	
		Reference impedance	50.0 Ω	
Avg		Averaging count	Averaging count	1 (OFF)
			Averaging type	SUM
		RBW	AUTO	
		Smoothing	0 % (OFF)	
		Delay aperture	0.4 %	
Sweep		Sweep time	Sweep time	AUTO
			Sweep mode	Repeat sweep
		Full/MKR sweep	Full sweep	
		Number of measurement points	501	
		Breakpoint	1001	

Appendix B

Key group	Master key	Function	Default
	Sweep	Sweep trigger source	Internal
		External trigger mode	Normal
		External trigger slope	Rising
Display	Active	Active trace	Trace A
	Scale	Scale	See Table 1
		Offset	See Table 1
		Offset line	See Table 1
		Electric length	0.00 mm
	Trace	Split display	OFF
		Waveform storage	OFF
		Waveform overwrite	OFF
		Display grid	ALL
		Display/erase item	See Table 2
		Subtrace	OFF
Marker	Marker	Marker	Marker 0: ON
		Active marker	0
		Marker value	Normal
		Reference marker	0
		Coupled marker	ON
		Marker list display	OFF
	Fctn	Marker Tracking	OFF
	X-S	Normalization	OFF
Calibration	Cal	Calibration method	Response
		Through line offset length	0.00 mm
		Open offset length	0.00 mm
		Short offset length	0.00 mm
		CAL ON/OFF	OFF
Utility	Filter	Filter analysis function	OFF
	Resonator	Resonator analysis function	OFF
	Limit	Limited test	OFF
Copy&Memory	Copy control	GPIB My address	1
		Control Function	Device
		Enable Register All	OFF
		Terminator	CR/LF&EOI
		Time Out	20 sec
		Active Port	GPIB
		Copy device	Video out
		GPIB Address	17
		Form Feed	ON
	Save/Recall	Save Item	PARAM
		Drive	FD
System	System	Marker setting mode	Point
		Impedance measurement method	Transfer
		Screen color	See Table 3

List of Defaults

Table 1 Scale, offset, an offset line defaults by analysis format
min = Minimum resolution

Analysis format	Scale default	Offset default	Offset line default
LOGMAG	10 dB	-50.000 dB	5 (Center)
PHASE	50 deg	0.000 deg	5 (Center)
DELAY	min × 100000	0 sec	5 (Center)
POLAR	min × 100000	0	5 (Center)
IMPD	min × 100000	0	5 (Center)
ADMT	min × 100000	0	5 (Center)
VSWR	min × 100000	1.000	10 (Bottom)
LINMAG	min × 100000	0	5 (Center)
REAL	min × 100000	0	5 (Center)
IMAGE	min × 100000	0	5 (Center)
LOG Z	5 decade	1 Ω	10 (Bottom)
θ	50 deg	0.000 deg	5 (Center)
Q	min × 100000	0	10 (Bottom)

Table 2 Display/erase item defaults

The items which are set ON can be erased or displayed by pressing the “Display All” key.

Item	Default
Setup-A	ON
Setup-B	ON
Meas PRMS	ON
Frequency	OFF
Menu	OFF
Sweep MKR	ON
Chart-A	OFF
Chart-B	OFF
Trace-A	OFF
Trace-B	OFF
Marker-A	ON
Marker-B	ON
Top Line	ON

Appendix B

Table 3 Screen color defaults

Screen name	Screen No.	Color default
Back Ground	Background	Dark black
Menu	Screen 15	White
Window	Screen 4	Blue
Chart-A	Screen 13	Dark white
Chart-B	Screen 14	Dark white
Trace-A	Screen 8	Green
Trace-B	Screen 9	Yellow
Marker-A	Screen 5	Light blue
Marker-B	Screen 6	Violet
Limit-A	Screen 10	Dark green
Limit-B	Screen 11	Dark yellow
Storage	Screen 12	Red
PTA	Screen 7	White
Error message	Screen 1	Red

Appendix C

List of Controls and Connectors on Front and Rear Panels

Front Panel

1 Preset:

Pressing the  key initializes all measurement parameters excluding some backup parameters.

2 Local:

Pressing the  key stops remote control performed through the GPIB, allowing you to operate the front panel manually. When this system is locked out of the local controller, it cannot return to the local state. The REMOTE LED goes on when the system enters the remote state and it goes out when the system enters the local state. The GPIB-related menu is also displayed.

3 PTA:

This switch turns on the PTA function.

19 Power switch:

When the pushbutton is depressed, the system is powered. Power is supplied to all circuits in the system. The system is ready for use. When the pushbutton is projected after being pressed again, the system is turned off.

20 PMC insertion slot (option):

Insert the PMC with the triangle printed on the PMC with the  mark on the front panel of the main unit. While the PMC is being accessed, the Busy lamp is lit. When the battery incorporated in the PMC is nearly used up, the Battery lamp lights up.

16 Backlight off:

Pressing this key toggles the backlight ON and OFF.

17 Display all:

Pressing this key between all items and only the selected items.

18 Window close:

Pressing this key closes the current window.

12 Calibration:

A group of keys used to perform calibration.

23 To Keyboard:

Appendix C

This connector is used to connect the keyboard for PTA.

13 Display:

A group of keys for the screen display.

24 Outputs:

A measurement signal output connector.

25 Inputs:

A measurement signal input connector.

26 Probe source:

This connector is used to supply power to an external application device.

15 Copy/Memory:

A group of keys used to create hard copies and save/recall data.

21 FD insertion slot:

Insert a floppy disk into this slot. While the data on the floppy disk is being accessed, the LED is lit.

7 Shift:

Pressing this key enables the functions (shift functions) displayed in blue.

6 TEN key:

A key group consisting of 16 keys. Generally, it is called a ten keypad. The 16 keys include numeric keys, a unit key, and a BS (backspace) key. Twelve numeric keys represent digits 0 to 9, decimal point (.), plus and minus signs. A unit key is used to set a distance, time (delay), or frequency. A unit of measure is selected depending on the function for which you are entering data now. Pressing the unit key completes data input. To complete input of data which is not followed by a unit of measure, press the ENTER key. Use the BS key to correct typos.

5 Arrow keys:

< and > keys have the following functions:

- Pressing the < key moves the reverse cursor to the left.
- Pressing the > key moves the reverse cursor to the right.
- When the  key is depressed, pressing the < key moves the active marker to the left (the active marker moves in 1/10 steps each time the < key is pressed). Pressing the > key moves the active marker to the right.

List of Controls and Connectors on Front and Rear Panels

4 Knob:

The ENTRY knob is used to vary the data displayed in the entry response area continuously. It is also used to perform the following functions:

- Turning the knob counterclockwise moves the cursor to the left and turning it clockwise moves the cursor to the right.
- When the  key is depressed, turning the knob counterclockwise moves the active marker to the left and turning it clockwise moves the active marker to the right.
- When the Scale menu is selected, turning the knob clockwise changes the vertical scale in 1-2-5 steps and turning it counterclockwise changes the vertical scale in 5-2-1 steps.

11 Measurement:

A group of keys used to set measurement conditions.

10 Maker:

A group of keys used to handle the marker.

9 Channels:

A group of keys used to select measurement items.

8 Soft keys:

Most keys on the front panel have a soft key menu. Pressing the soft key (F1 to F6) corresponding to a desired menu option performs the associated function.

22 LCD Display:

A 640-by-480-dot, 6.5-inch, color LCD.

Back Panel

29 Module Bus:

An extended bus connector used to control an external device (compatible with the Anritsu module bus).

30 PTA I/O Port:

This port is used to control an external device by the PTA function or to control PTA from outside. Control signals are all negative. Control must be programmed using a PTL language.

31 RGB:

Use this connector to connect a color monitor with a analog RGB Input connector.

32 Separate Video:

Use this connector to create a hard copy using a plotter with a Separate Video Signal Input connector.

33 GPIB:

When using GPIB, connect an external device (personal computer, etc.) to this connector.

37 FG:

To prevent electric shock, connect this terminal (frame ground terminal) to the ground level.

Appendix C

38 Fuse:

A fuse holder containing two 5-A fuses. The symbol “T” stands for a pre-arcing time/current characteristic, indicating that there is a time lag before the fuse blows. These fuses conform to the IEC standard. For details, see the IEC Pub 127 sheet.

39 Line input:

An AC inlet into which the enclosed power cord is inserted. The ground wire of the 3-core power cord is grounded to the ground terminal when the power cord is plugged into this AC inlet.

34 RS232C (option):

Use this port to connect an external device having an RS232C port.

35 Centronics (option):

Use this port to connect an external device having a Centronics port.

36 FAN:

A fan used to prevent the internal temperature from rising excessively. Ensure that the system is installed with a minimum clearance of 10 cm from the rear vent to the wall.

27 Ext. Trigger:

The trigger input connector when the start trigger of sweep is external. The signal level is TTL.

28 FAN:

- Ext: The reference signal input connector when the external reference oscillator is used. The internal reference oscillator is used when the external signal is not supplied.
- Buffer: The reference signal output connector through the buffer.

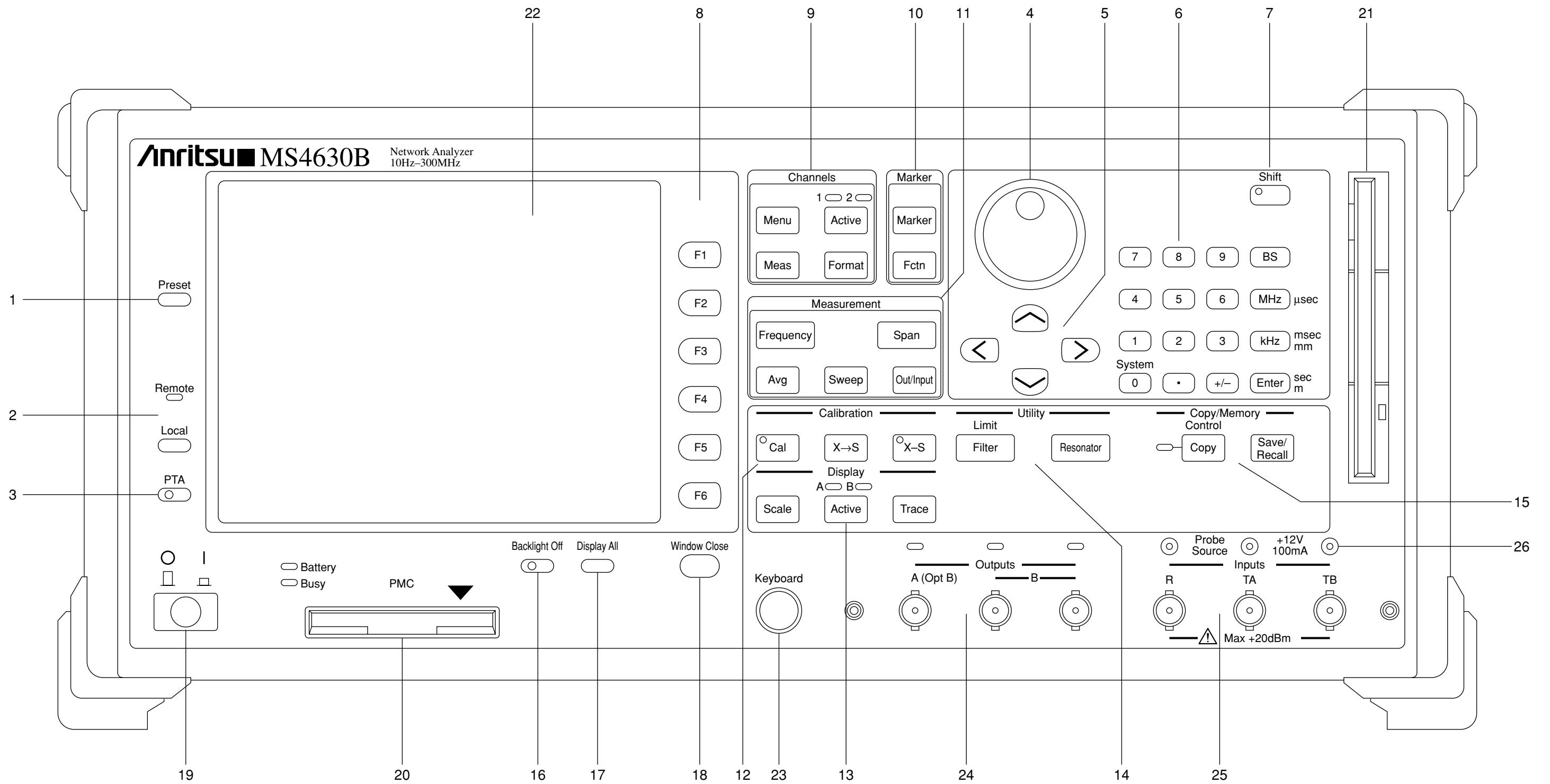

Fig.C-1 Front Panel

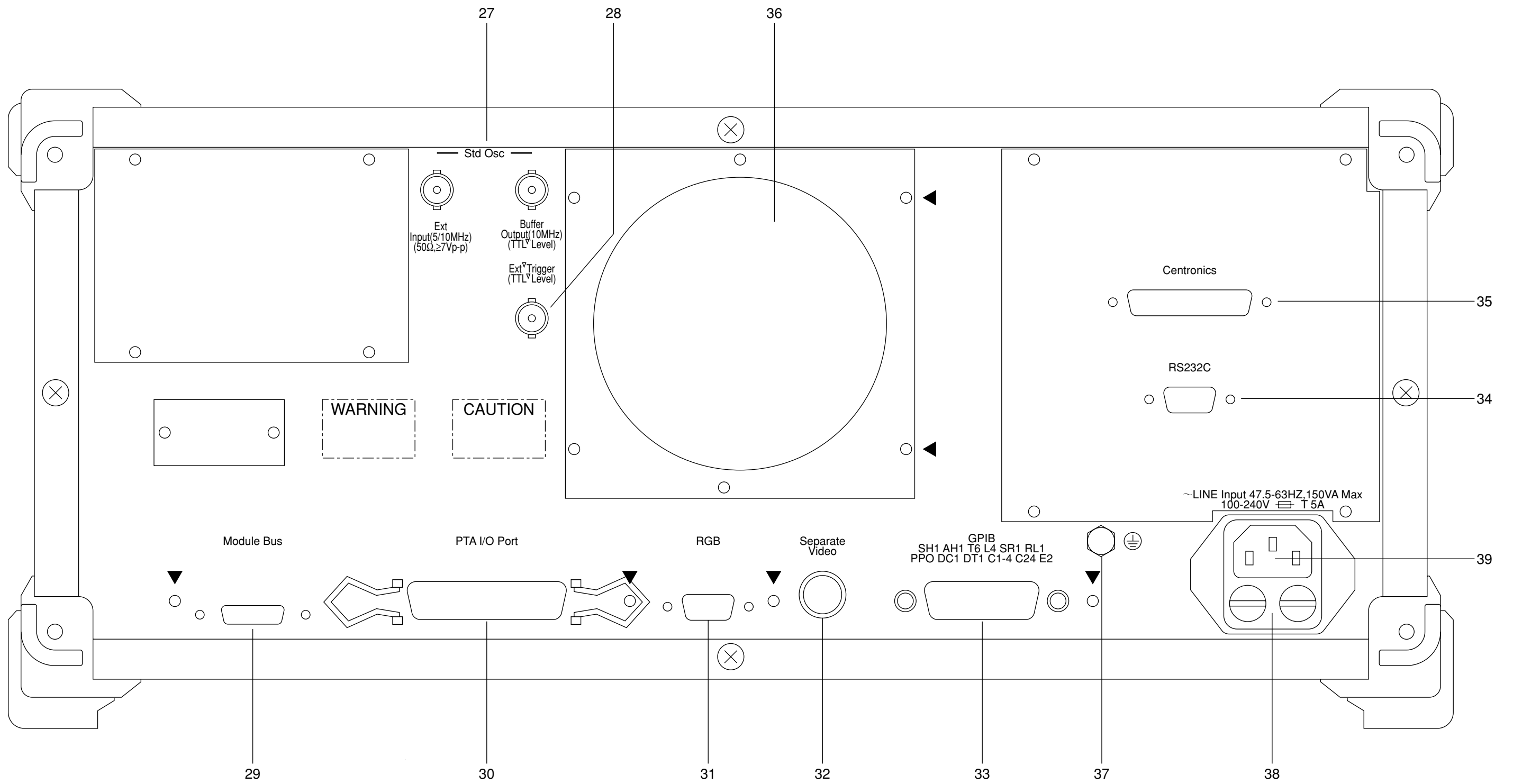

Fig.C-2 Back Panel

Appendix D List of Error Message

(1) Media related error

Error Message	Error Detail
MISSING MEDIA	Media (Note) has not been mounted.
NOT FORMATED	Media (Note) has not been formatted.
DIFFERENT FORMATTING	The type of formatting is different.
MEDIA PROTECTED	Media is write protected.
INVALID MEDIA	Media (Note) is broken.
MEDIA FULL	The media memory is full.
FILE NOT FOUND	A file is not found.
DIFFERENT MEDIA TYPE	The media (Note) type is different.
UNDIFINED FILE	The file to be defined has not been registered.
MEDIA ERROR	Other error
DIFFERENT VERSION	A file saved by a new version equipment was attempted to be loaded by an older version equipment.
NO DATA	No data to save.
Please Select FD	Select a floppy disk drive.

NOTE:

Media refers to an internal memory, FD or PMC.

(2) Error related to external interface

Error Message	Error Detail
PORT NOT CONTROLLER	Cannot execute because GPIB or RS-232 is not controller.
DEVICE NOT CONNECTED	No device (printer) is connected to GPIB.
TIMEOUT ERROR	The specified time has elapsed, but there was no response from other party.

(3) Message related to equipment anomaly

Error Message	Error Detail
CAUTION FAN IS STOPPING Entire screen flashes in red along with message.	Back panel fan is stopped.

Appendix D

Appendix E Example of Settings for Video Plotter VP1500 II (Manufactured by SEIKOSYA)

The following table lists the settings (examples) of the plotter used to output the separate video signal of the MS4630B network analyzer to the VP1500 II video plotter.

Set the following items in this order according to the operation manual of this plotter.

VP1500 II Mode No.	Function name	Setting value
01	Initial setting	000 (OFF)
02	Signal type	002 (Separate video)
03	Scanning method	001 (Non-interlace)
07	Print direction	002 (Lateral)
04	Sampling clock	001 (External clock)
08	Resolution	000 (Normal)
09	Reverse video	001 (Reverse)
10	Lateral trimming	000 (0 dot)
11	Longitudinal trimming	000 (0 raster)
12	Width of image	112 (112mm)
13	Height of image	506 (506 rasters)
14	Length of recording paper	106 (106mm)
15	Top margin	016 (16mm)
16	Left margin	010 (10mm)

Appendix E