

OMRON

OMRON Corporation
Industrial Automation Company

Measuring and Control Division
Shiokoji Horikawa, Shimogyo-ku,
Kyoto, 600-8530 Japan
Tel: (81)75-344-7080/Fax: (81)75-344-7189

Regional Headquarters

OMRON EUROPE B.V.
Wegalaan 67-69, NL-2132 JD Hoofddorp
The Netherlands
Tel: (31)2356-81-300/Fax: (31)2356-81-388

OMRON ELECTRONICS LLC
1 East Commerce Drive, Schaumburg, IL 60173
U.S.A.
Tel: (1)847-843-7900/Fax: (1)847-843-8568

OMRON ASIA PACIFIC PTE. LTD.
83 Clemenceau Avenue,
#11-01, UE Square,
239920 Singapore
Tel: (65)6835-3011/Fax: (65)6835-2711

OMRON CHINA CO., LTD.
BEIJING OFFICE
Room 1028, Office Building,
Beijing Capital Times Square,
No. 88 West Chang'an Road,
Beijing, 100031 China
Tel: (86)10-8391-3005/Fax: (86)10-8391-3688

Authorized Distributor:

OMRON

OMRON

E5CN Digital Temperature Controller Communications Functions

User's Manual

H130-E1-01

E5CN

Digital Temperature Controller

Communications Functions

User's Manual

Cat. No. H130-E1-01

Overview

CompoWay/F

Com Data

SYSWAY

Modbus

Appendix

Preface

The E5CN supports CompoWay/F and SYSWAY serial communications specifications.

This User's Manual describes the communications functions of the E5CN. Before using your E5CN, thoroughly read and understand this manual in order to ensure correct use. Also, store this manual in a safe place so that it can be retrieved whenever necessary.

© **OMRON, 2004**

All rights reserved. No part of this publication may be reproduced, stored in a retrieval system or transmitted, in any form, or by any means, mechanical, electronic, photocopying, recording, or otherwise, without the prior written permission of OMRON.

No patent liability is assumed with respect to the use of the information contained herein. Moreover, because OMRON is constantly striving to improve its high-quality products, the information contained in this manual is subject to change without notice. Every precaution has been taken in the preparation of this manual. Nevertheless, OMRON assumes no responsibility for errors or omissions. Neither is any liability assumed for damages resulting from the use of the information contained in this publication.

Read and Understand this Manual

Please read and understand this manual before using the product. Please consult your OMRON representative if you have any questions or comments.

Warranty and Limitations of Liability

WARRANTY

OMRON's exclusive warranty is that the products are free from defects in materials and workmanship for a period of one year (or other period if specified) from date of sale by OMRON.

OMRON MAKES NO WARRANTY OR REPRESENTATION, EXPRESS OR IMPLIED, REGARDING NON-INFRINGEMENT, MERCHANTABILITY, OR FITNESS FOR PARTICULAR PURPOSE OF THE PRODUCTS. ANY BUYER OR USER ACKNOWLEDGES THAT THE BUYER OR USER ALONE HAS DETERMINED THAT THE PRODUCTS WILL SUITABLY MEET THE REQUIREMENTS OF THEIR INTENDED USE. OMRON DISCLAIMS ALL OTHER WARRANTIES, EXPRESS OR IMPLIED.

LIMITATIONS OF LIABILITY

OMRON SHALL NOT BE RESPONSIBLE FOR SPECIAL, INDIRECT, OR CONSEQUENTIAL DAMAGES, LOSS OF PROFITS OR COMMERCIAL LOSS IN ANY WAY CONNECTED WITH THE PRODUCTS, WHETHER SUCH CLAIM IS BASED ON CONTRACT, WARRANTY, NEGLIGENCE, OR STRICT LIABILITY.

In no event shall the responsibility of OMRON for any act exceed the individual price of the product on which liability is asserted.

IN NO EVENT SHALL OMRON BE RESPONSIBLE FOR WARRANTY, REPAIR, OR OTHER CLAIMS REGARDING THE PRODUCTS UNLESS OMRON'S ANALYSIS CONFIRMS THAT THE PRODUCTS WERE PROPERLY HANDLED, STORED, INSTALLED, AND MAINTAINED AND NOT SUBJECT TO CONTAMINATION, ABUSE, MISUSE, OR INAPPROPRIATE MODIFICATION OR REPAIR.

Application Considerations

SUITABILITY FOR USE

OMRON shall not be responsible for conformity with any standards, codes, or regulations that apply to the combination of products in the customer's application or use of the products.

At the customer's request, OMRON will provide applicable third party certification documents identifying ratings and limitations of use that apply to the products. This information by itself is not sufficient for a complete determination of the suitability of the products in combination with the end product, machine, system, or other application or use.

The following are some examples of applications for which particular attention must be given. This is not intended to be an exhaustive list of all possible uses of the products, nor is it intended to imply that the uses listed may be suitable for the products:

- Outdoor use, uses involving potential chemical contamination or electrical interference, or conditions or uses not described in this manual.
- Nuclear energy control systems, combustion systems, railroad systems, aviation systems, medical equipment, amusement machines, vehicles, safety equipment, and installations subject to separate industry or government regulations.
- Systems, machines, and equipment that could present a risk to life or property.

Please know and observe all prohibitions of use applicable to the products.

NEVER USE THE PRODUCTS FOR AN APPLICATION INVOLVING SERIOUS RISK TO LIFE OR PROPERTY WITHOUT ENSURING THAT THE SYSTEM AS A WHOLE HAS BEEN DESIGNED TO ADDRESS THE RISKS, AND THAT THE OMRON PRODUCTS ARE PROPERLY RATED AND INSTALLED FOR THE INTENDED USE WITHIN THE OVERALL EQUIPMENT OR SYSTEM.

PROGRAMMABLE PRODUCTS

OMRON shall not be responsible for the user's programming of a programmable product, or any consequence thereof.

Disclaimers

CHANGE IN SPECIFICATIONS

Product specifications and accessories may be changed at any time based on improvements and other reasons.

It is our practice to change model numbers when published ratings or features are changed, or when significant construction changes are made. However, some specifications of the products may be changed without any notice. When in doubt, special model numbers may be assigned to fix or establish key specifications for your application on your request. Please consult with your OMRON representative at any time to confirm actual specifications of purchased products.

DIMENSIONS AND WEIGHTS

Dimensions and weights are nominal and are not to be used for manufacturing purposes, even when tolerances are shown.

PERFORMANCE DATA

Performance data given in this manual is provided as a guide for the user in determining suitability and does not constitute a warranty. It may represent the result of OMRON's test conditions, and the users must correlate it to actual application requirements. Actual performance is subject to the OMRON Warranty and Limitations of Liability.

ERRORS AND OMISSIONS

The information in this document has been carefully checked and is believed to be accurate; however, no responsibility is assumed for clerical, typographical, or proofreading errors, or omissions.

Safety Precautions

■ Definition of Precautionary Information

The following notation is used in this manual to provide precautions required to ensure safe usage of the product.

The safety precautions that are provided are extremely important to safety. Always read and heed the information provided in all safety precautions.

The following notation is used.









Indicates a potentially hazardous situation which, if not avoided, is likely to result in minor or moderate injury or in property damage.

■ Symbols

Symbol		Meaning
Caution		General Caution Indicates non-specific general cautions, warnings, and dangers.
		Electrical Shock Caution Indicates possibility of electric shock under specific conditions.
Prohibition		General Prohibition Indicates non-specific general prohibitions.
Mandatory Caution		General Caution Indicates non-specific general cautions, warnings, and dangers.

■ Safety Precautions

 CAUTION	
<p>Do not touch the terminals while power is being supplied. Doing so may occasionally result in minor injury due to electric shock.</p>	
<p>Do not allow pieces of metal, wire clippings, or fine metallic shavings or filings from installation to enter the product. Doing so may occasionally result in electric shock, fire, or malfunction.</p>	
<p>Do not use the product where subject to flammable or explosive gas. Otherwise, minor injury from explosion may occasionally occur.</p>	
<p>Never disassemble, modify, or repair the product or touch any of the internal parts. Minor electric shock, fire, or malfunction may occasionally occur.</p>	
<p>CAUTION - Risk of Fire and Electric Shock a) This product is UL listed as Open Type Process Control Equipment. It must be mounted in an enclosure that does not allow fire to escape externally. b) When using more than one shutoff switch, always turn OFF all the shutoff switches to ensure that no power is being supplied before servicing the product. c) Signal inputs are SELV, limited energy.*1 d) Caution: To reduce the risk of fire or electric shock, do not interconnect the outputs of different Class 2 circuits.*2</p>	
<p>If the output relays are used past their life expectancy, contact fusing or burning may occasionally occur. Always consider the application conditions and use the output relays within their rated load and electrical life expectancy. The life expectancy of output relays varies considerably with the output load and switching conditions.</p>	

*1 An SELV circuit is one separated from the power supply with double insulation or reinforced insulation, that does not exceed 30 V r.m.s. and 42.4 V peak or 60 VDC.

*2 A class 2 power supply is one tested and certified by UL as have the current and voltage of the secondary output restricted to specific levels.

 **CAUTION**

Tighten the terminal screws to between 0.74 and 0.9 N.m. Loose screws may occasionally result in fire.

Set the parameters of the product so that they are suitable for the system being controlled. If they are not suitable, unexpected operation may occasionally result in property damage or accidents.

WARNING: To reduce the risk of electric shock or fire, install the product in a controlled environment relatively free of contaminants.

A malfunction in the Temperature Controller may occasionally make control operations impossible or prevent alarm outputs, resulting in property damage. To maintain safety in the event of malfunction of the Temperature Controller, take appropriate safety measures, such as installing a monitoring device on a separate line.



Precautions for Safe Use

- 1) Do not use this product in the following places:
 - Places directly subject to heat radiated from heating equipment.
 - Places subject to splashing liquid or oil atmosphere.
 - Places subject to direct sunlight.
 - Places subject to dust or corrosive gas (in particular, sulfide gas and ammonia gas).
 - Places subject to intense temperature change.
 - Places subject to icing and condensation.
 - Places subject to vibration and large shocks.
- 2) Use and store the Digital Temperature Controller within the rated ambient temperature and humidity. Gang-mounting two or more temperature controllers, or mounting temperature controllers above each other may cause heat to build up inside the temperature controllers, which will shorten their service life. In such a case, use forced cooling by fans or other means of air ventilation to cool down the Digital Temperature Controllers.
- 3) To allow heat to escape, do not block the area around the product. Do not block the ventilation holes on the product.
- 4) Be sure to wire properly with correct polarity of terminals.
- 5) Use specified size (M3.5, width 7.2 mm or less) crimped terminals for wiring. Use wires with a gage of AWG24 to AWG14 (equal to cross-sectional areas of 0.205 to 2.081 mm²). (The stripping length is 5 to 6 mm.)
- 6) Do not wire the terminals which are not used.
- 7) To avoid inductive noise, keep the wiring for the Digital Temperature Controller's terminal block away from power cables carry high voltages or large currents. Also, do not wire power lines together with or parallel to Digital Temperature Controller wiring. Using shielded cables and using separate conduits or ducts is recommended.

Attach a surge suppressor or noise filter to peripheral devices that generate noise (in particular, motors, transformers, solenoids, magnetic coils or other equipment that have an inductance component).

When a noise filter is used at the power supply, first check the voltage or current, and attach the noise filter as close as possible to the temperature controller.

Allow as much space as possible between the Digital Temperature Controller and devices that generate powerful high frequencies (high-frequency welders, high-frequency sewing machines, etc.) or surge.
- 8) Use this product within the rated load and power supply.
- 9) Make sure that the rated voltage is attained within two seconds of turning the power ON.
- 10) Make sure the controller has 30 minutes or more for warm up.
- 11) When using self-tuning, turn ON power for the load (e.g., heater) at the same time as or before supplying power to the Digital Temperature Controller. If power is turned ON for the Digital Temperature Controller before turning ON power for the load, self-tuning will not be performed properly and optimum control will not be achieved.
- 12) A switch or circuit breaker should be provided close to this unit. The switch or circuit breaker should be within easy reach of the operator, and must be marked as a disconnecting means for this unit.
- 13) Always turn OFF the power supply before pulling out the interior of the product, and never touch nor apply shock to the terminals or electronic components. When inserting the interior of the product, do not allow the electronic components to touch the case.
- 14) Do not use paint thinner or similar chemical to clean with. Use standard grade alcohol.

- 15) Design system (control panel, etc) considering the 2 second of delay that the controller's output to be set after power ON.
- 16) The output may turn OFF when shifting to certain levels. Take this into consideration when performing control.

Conventions Used in This Manual

■ How This Manual is Organized

Descriptions in this manual are separated by the communications method.

Read the sections that are application to the system being used.

Overview

CompoWay/F

Communications Data
CompoWay/F•SYSWAY

SYSWAY

Modbus

Appendix

Overview

CompoWay/F

Com Data

SYSWAY

Modbus

Appendix

■ Related Manuals

This manual describes the communications functions of the E5CN.
For details on the functions of the E5CN, refer to the User's Manual.

Table of Contents

Preface	I
Read and Understand this Manual	II
Warranty and Limitations of Liability	II
Application Considerations	II
Disclaimers	III
Safety Precautions	IV
Precautions for Safe Use	VII
Conventions Used in This Manual	IX

SECTION 1

Communications Methods

1.1 Overview of Communications Methods.....	1-2
Introduction	1-2
Communications Specifications	1-3
Transmission Procedure	1-3
Interface	1-4
Wiring.....	1-4
Communications Parameters.....	1-5

SECTION 2

CompoWay/F Communications Procedures

2.1 Data Format	2-2
Command Frame	2-2
Response Frame	2-3
Communications Data.....	2-4
End Code Example	2-4
2.2 Structure of Command Text	2-6
PDU Structure.....	2-6
Area Definitions.....	2-6
Type Code (Variable Type).....	2-6
Addresses	2-7
Number of Elements	2-7
List of Services.....	2-7
2.3 Detailed Description of the Services	2-9
Read Variable Area.....	2-9
Write Variable Area.....	2-10
Read Controller Attributes.....	2-12
Read Controller Status.....	2-13
Echoback Test	2-14
Operation Command.....	2-15
2.4 Response Code List.....	2-20

SECTION 3

Communications Data for CompoWay/F and SYSWAY

3.1 Variable Area (Setting Range) List.....	3-2
3.2 Status	3-15

SECTION 4

SYSWAY (E5□J and E5□X Format) Communications Procedures

4.1	Data Format	4-2
	Command Frame Format.....	4-2
	Response Frame	4-3
	Communications Data.....	4-3
	SYSWAY Command Lists.....	4-4
4.2	Command Descriptions.....	4-5
	Read Process Value	4-5
	Write Set Values	4-6
	Read Set Values and MV Monitor.....	4-7
	Select Communications Writing	4-9

SECTION 5

Modbus Communications Procedure

5.1	Data Format	5-2
	Command Frame	5-2
	Response Frame	5-4
	Error Codes.....	5-5
5.2	Function List.....	5-6
5.3	Variable Area.....	5-7
5.4	Detailed Description of the Services	5-9
	Read Variable Area.....	5-9
	Write Variable Area	5-11
	Operation Commands	5-14
	Echoback Test	5-19

SECTION 6

Communications Data for Modbus

6.1	Variable Area (Setting Range) List.....	6-2
6.2	Status	6-15

Appendix

	ASCII List	A-2
--	------------------	-----

SECTION 1

Communications Methods

This section briefly describes the supported communications methods and how to wire equipment. Refer to this section when setting up equipment.

1.1	Overview of Communications Methods	1-2
	Introduction.....	1-2
	Communications Specifications.....	1-3
	Transmission Procedure.....	1-3
	Interface.....	1-4
	Wiring	1-4
	Communications Parameters	1-5
	Communications Parameter Setup	1-5
	Communications Parameters.....	1-6

1.1 Overview of Communications Methods

■ Introduction

The program for the communications functions are created on the host computer, and the E5CN's parameters are monitored or set from the host computer. Therefore, the description provided here is from the viewpoint of the host computer.

CompoWay/F is OMRON's standard communications format for general serial communications. This format uses a standard frame format as well as the well-established FINS* commands used for OMRON's PLCs. Therefore, it can simplify communications between components and the host computer.

*FINS (Factory Interface Network service)

The FINS protocol provides message communications between controllers in OMRON FA networks.

Modbus is a standard communications control method that conforms to the Modicon Company's RTU-mode Modbus Protocol (PI-MBUS-300 Revision J). Supports functions equivalent to the CompoWay/F Read Variable Area, Write Variable Area, Operation Command, and Echoback Test functions.

The E5CN supports the following communications functions.

- Reading/writing of parameters
- Operation instructions
- Selection of setup levels

Communications are subject to the following condition:

- Parameters can be written only when the "communications writing" parameter is set to ON (enabled).

■ Communications Specifications

Transmission line connection	RS-485: Multidrop
Communications method	RS-485 (2-wire, half-duplex)
Synchronization method	Start-stop synchronization
Communications baud rate (See note.)	1,200, 2,400, 4,800, 9,600 , 19,200 or 38,400 bps
Communications code	ASCII
Communications data bits (See note.)	7 or 8 bits
Communications stop bits (See note.)	1 or 2 bits 2
Error detection	Vertical parity (none, even , or odd) FCS (Frame Check Sequence) with SYSWAY communications BCC (Block Check Character) with CompoWay/F communications CRC-16 (Cyclic Redundancy Check 16) with Modbus communications
Flow control	None
Interface	RS-485
Retry function	None
Communications buffer	40 bytes
Communications response wait time	0 to 99 ms, default time: 20 ms

Note: Communications speed, data bits, stop bits and vertical parity can each be set independently in the communications setting level. Highlighted values indicate default settings.

■ Transmission Procedure

When the host computer transmits a command frame, the E5CN transmits a response frame that corresponds to the command frame. A single response frame is returned for each command frame. The following diagram shows the operation of the command and response frames.

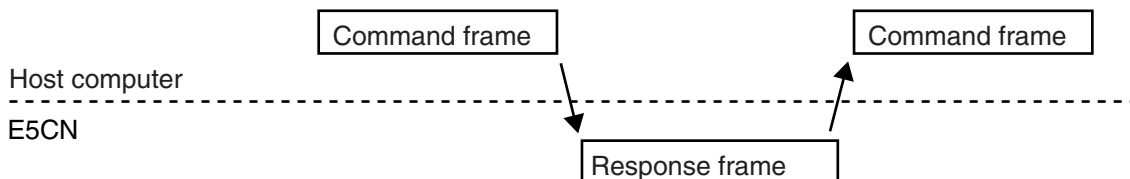

Allow a wait time of at least 2 ms before the next command is sent after the host computer receives a response from the E5CN.

Interface

Communications with the host computer are carried out through a standard RS-485 interface. Use a K3SC Interface Converter for RS-485 interface conversion.

Wiring

RS-485

- The RS-485 connection can be either one-to-one or one-to-N. Up to 32 units including the host computer can be connected in a one-to-N system.
- The total cable length is 500 m max.
- Use a shielded twisted-pair cable with wires of a thickness of AWG24 (0.205 mm²) to AWG14 (2.081 mm²).

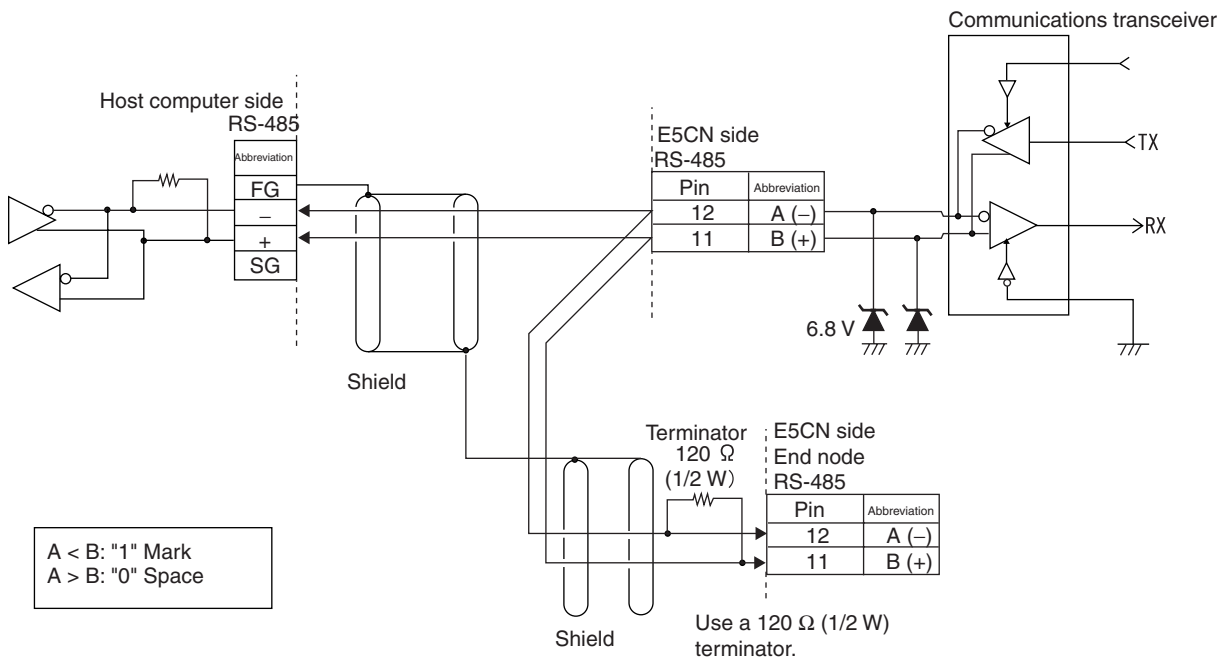

Specify both ends of the transmission path including the host computer as the end node (that is, connect terminators to both ends). Use a terminating resistance of at least 54 Ω.

Match the communications specifications of the E5CN and the host computer. When using a 1: N connection, set the same communications specifications in all of the Units. (Of course, each Unit must have a unique unit number.)

This section explains how to set the E5CN's communications specifications. For details on the host computer, refer to the User's Manual provided with the host computer.

■ Communications Parameters

The E5CN's communications specifications are set in the communications setting level. These parameters are set on the E5CN's front panel. The following table shows the communications parameters and their setting ranges.

Item	Code	Settings	Set Values
Communications protocol	<i>PSEL</i>	CompoWay/F (SYSWAY)/Modbus	COM /Mod
Communications unit number	<i>U-Nb</i>	0 to 99	0 1 to 99
Communications baud rate	<i>bPS</i>	1.2/2.4/4.8/9.6/19.2/38.4 (kbit/s)	1.2/2.4/4.8/ 9.6 /19.2/38.4 (kbit/s)
Communications data length	<i>LEN</i>	7/8 (bit)	7 /8 (bit)
Communications stop bits	<i>StBt</i>	1/2	1/ 2
Communications parity	<i>PRTY</i>	None, Even, Odd	NONE /EVEN/odd
Send data wait time	<i>sdWt</i>	0 to 99	0 to 99 ms, default time: 20 ms

Highlighted values indicate default settings.

● Communications Parameter Setup

Before you carry out communications with the E5CN, set up the communications unit number, baud rate, and other parameters by carrying out the following procedure. For details on operations other than communications parameter setup, refer to the Operation Manuals for the devices being used.

- 1.** Press the LEVEL Key for at least three seconds to move from the “operation level” to the “initial setting level.”
- 2.** Press the LEVEL Key for less than one second to move from the “initial setting level” to the “communications setting level.”
- 3.** Select the parameters as shown below by pressing the MODE Key.

4. Use the DOWN or UP Keys to change the parameter set values.

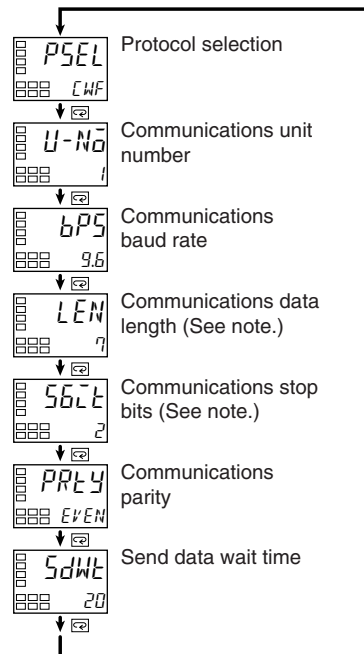

Note: The “Protocol selection” setting is displayed only when CompoWay/F communications are being used.

● Communications Parameters

When communications parameter settings have been changed, the new settings must be enabled by resetting the Controller.

- **Protocol Selection (*PSEL*)**
The communications protocol can be selected. Set CompoWay/F (SYSWAY) or Modbus.
- **Communications Unit Number (*U-Nb*)**
This parameter is for setting a unique unit number for each of the Temperature Controllers. This unit number is set so that the host computer can identify the Temperature Controller when communications are carried out with the host computer. The unit number can be set to an integer value between 0 and 99. The default is “1.” When two or more Temperature Controllers are used, do not set the same unit number. Doing so will prevent normal operation.
- **Communications Baud Rate (*bPS*)**
Sets the baud rate for communications with the host computer. The communications baud rate settings are as follows: 1.2 (1200 bps), 2.4 (2400 bps), 4.8 (4800 bps), 9.6 (9600 bps), 19.2 (19200 bps), and 38.4 (38400 bps)
- **Communications Data Length (*LEN*)**
This parameter is for setting the number of communications data bits. Set either “7 bits” or “8 bits.”

- Communications Stop Bits (*St̄t*)
This parameter is for setting the number of communications stop bits. Set either “1” or “2.”
- Communications Parity (*PR̄t*)
The communications parity can be set. Set the parity to “none,” “even,” or “odd.”
- Send Data Wait Time (*sdwt*)
The send data wait time can be set in 1-ms increments between 0 and 99 ms. The default is 20 ms.

SECTION 2

CompoWay/F Communications Procedures

Read this section if you are to communicate using the CompoWay/F format.

2.1	Data Format.....	2-2
	Command Frame.....	2-2
	BCC Calculation Example.....	2-3
	Response Frame.....	2-3
	Communications Data.....	2-4
	End Code Example.....	2-4
2.2	Structure of Command Text.....	2-6
	PDU Structure.....	2-6
	Area Definitions.....	2-6
	Type Code (Variable Type).....	2-6
	Addresses.....	2-7
	Number of Elements.....	2-7
	List of Services.....	2-7
2.3	Detailed Description of the Services.....	2-9
	Read Variable Area.....	2-9
	Write Variable Area.....	2-10
	Read Controller Attributes.....	2-12
	Read Controller Status.....	2-13
	Echoback Test.....	2-14
	Operation Command.....	2-15
2.4	Response Code List.....	2-20

2.1 Data Format

Hexadecimal values are expressed by adding the prefix H' before the number, e.g., H'02. Numbers shown without the H' prefix are ASCII characters.

The number underneath each item in a frame indicates the number of bytes.

■ Command Frame

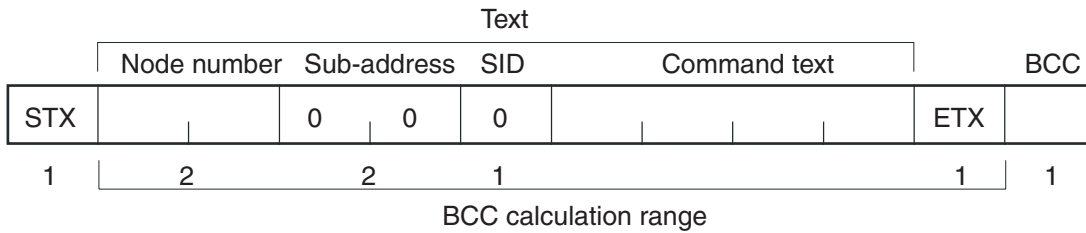

STX	This code (H'02) indicates the beginning of the communications frame (text). Always set this character in the first byte. When STX is received again during reception, reception is carried out again from the point where STX was received.
Node number	<ul style="list-style-type: none"> • This number specifies the transmission's destination. • Specify the E5CN's communications unit number. • A BCD value between 00 and 99 or an ASCII value of XX can be set. • Specify "XX" for a broadcast transmission. No responses will be returned for broadcast transmissions. • No responses will be returned from node numbers other than the ones in the above range.
Sub-address	The sub-address is not used in the E5CN. Be sure to set the sub-address to "00."
SID (Service ID)	The service ID is not used in the E5CN. Be sure to set the service ID to "00."
Command text	This is the command text area. For details, see <i>2.2 Structure of Command Text</i> .
ETX	This code (H'03) indicates the end of the text.
BCC	This is the Block Check Character. The BCC result is found by calculating the exclusive OR of the bytes from the node number up to ETX.

● BCC Calculation Example

The BCC (Block Check Character) is determined by calculating the exclusive OR of the bytes from the node number up to ETX. The 8-bit result is written to the BCC byte at the end of the frame.

STX	Node number				Sub-address				SID				Command text				ETX	BCC
02H	0 (30H)	0 (30H)	0 (30H)	0 (30H)	0 (30H)	0 (30H)	0 (30H)	0 (30H)	0 (30H)	5 (35H)	0 (30H)	3 (33H)			03H	35H		

$BCC = 30H \oplus 30H \oplus 30H \oplus 30H \oplus 30H \oplus 30H \oplus 30H \oplus 35H \oplus 30H \oplus 33H \oplus 03H = 35H$
 The result of the calculation (35 hex) is written to the BCC byte.

The ⊕ symbols indicate XOR (exclusive OR) operations.

■ Response Frame

STX	Node number		Sub-address		End code	Command text				ETX	BCC	
		0	0									
1	2	2	2	2						1	1	

End code	Name	Description	Error detection priority
00	Normal completion	The command ended normally without error.	None
0F	FINS command error	The specified FINS command could not be executed. The FINS response code should indicate why the command could not be executed.	8
10	Parity error	The sum total of bits whose received data is "1" does not match the set value of the "communications parity" bit.	2
11	Framing error	Stop bit is "0."	1
12	Overrun error	An attempt was made to transfer new data when the reception data buffer was already full.	3
13	BCC error	The calculated BCC value is different from the received BCC value.	5
14	Format error	<ul style="list-style-type: none"> The command text contains characters other than 0 to 9, and A to F. This error does not apply to Echoback Tests. (Refer to the Echoback Test for details.) There was no SID and command text. There was no command text. "MRC/SRC" not included in command text. 	7
16	Sub-address error	<ul style="list-style-type: none"> Illegal (unsupported) sub-address There was no sub-address, SID, and command text. Sub-address was less than two characters, and there was no SID and command text 	6
18	Frame length error	The received frame exceeds the specified (supported) number of bytes.	4

- An end code is returned for each command frame received that was addressed to the local node.
- No response will be returned unless the frame contained all elements up to the ETX and BCC.
- "Error Detection Priority" indicates the priority when two or more errors occur simultaneously.

■ Communications Data

Communications format	Set (monitor) values	Negative values	Decimal point
CompoWay/F	8-digit hexa-decimal	2's complement	Decimal point is removed and the result is converted to hexadecimal. Example conversion: 105.0 → 1050 → H'0000041A

■ End Code Example

The following examples show the end code when a command did not end normally.

Example 1) Illegal Sub-address, No SID, and No Command Text
Command

	Node number	Sub-address	BCC
STX		0 A	EXT

Response

	Node number	Sub-address	End code	BCC
STX		0 A	1 6	EXT

End code is "16" (sub-address error).

The sub-address error code is used because the sub-address error has a higher error detection priority than the format error.

Example 2) No Command Text
Command

	Node number	Sub-address	SID	BCC
STX		0 0	0	EXT

Response

	Node number	Sub-address	End code	BCC
STX		0 0	1 4	EXT

The end code is "14" (format error).

Example 3) No Node Number Provided
Command

	BCC
STX	EXT

The node number is lacking one character.

Response

There is no response.

Example 4) No Sub-address and Illegal BCC

Command

Node number		BCC	
STX		EXT	Err

Response

Node number		Sub-address		End code		BCC	
STX		0	0	1	3	EXT	

The sub-address is "00" and the end code is "13" (BCC error).

2.2 Structure of Command Text

■ PDU Structure

An MRC (Main Request Code) and SRC (Sub-Request Code) followed by the various required data is transferred to the command text.

Service Request PDU



The MRES (Main Response Code) and SRES (Sub-Response Code) are transferred to the response frame following the above MRC/SRC. Data is then transferred following the MRES and SRES.

Service Response PDU (Normal Response)



If the specified command text could not be executed, the service response PDU will contain only the MRC/SRC and MRES/SRES.

Service Response PDU (Command Text Not Executed)



The MRES and SRES become the response code when processing did not end in "normal completion."

■ Area Definitions

Areas comprise only the variable area.

■ Type Code (Variable Type)

The following tables show the variable area type codes.

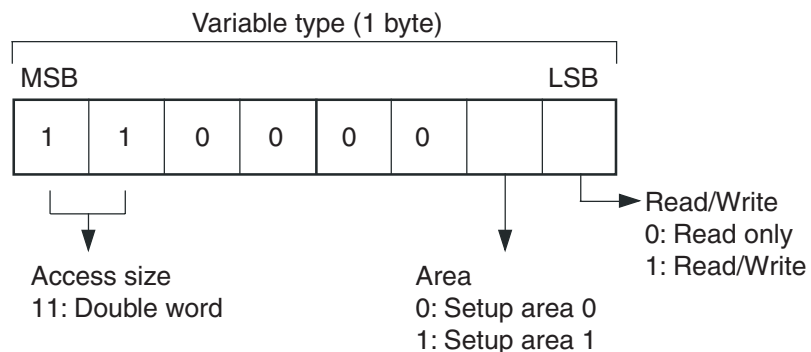

The following table summarizes setup areas 0 and 1.

Area	Description
Setup area 0	This area groups together the protect, manual control, operation, and adjustment levels.
Setup area 1	This area groups together the initial setting, communications setting, advanced function setting, and calibration levels.

The variable type is converted to 2-byte ASCII and loaded to the frame. The following table shows the available variable types.

Variable type	Description
C0	Double-word data. R/O (read only) parameter for setup area 0.
C1	Double-word data. R/W parameter for setup area 0.
C3	Double-word data. R/W parameter for setup area 1.

* Setup area 1 has no read-only parameters, so there is no variable type "C2."

■ Addresses

An address is appended to each of the variable types. Express addresses in 2-byte hexadecimal and append them for the specified access size.

■ Number of Elements

The number of elements is expressed in 2-byte hexadecimal. Specify the number of elements within the range "0 to 2."

For example, when the number of elements is "0002," this specifies two items of data from the address.

■ List of Services

MRC	SRC	Name of service	Processing
01	01	Read Variable Area	This service reads from variable areas.
01	02	Write Variable Area	This service writes to variable areas.
05	03	Read Controller Attributes	This service reads the model number and communications buffer size.
06	01	Read Controller Status	This service reads the operating status.
08	01	Echoback Test	This service performs an echoback test.
30	05	Operation Command	This service performs operations such as executing/stopping AT (auto-tuning) and moving to Setup Area 1.

- * No commands will be accepted and no responses will be returned when a memory error (RAM error) has occurred or the Controller is initializing (until the Controller recognizes the process value after the power is turned ON).

2.3 Detailed Description of the Services

■ Read Variable Area

This service reads data from a variable area.

Service Request PDU

MRC	SRC	Variable type	Read start address	Bit position	Number of elements
0 1	0 1			0 0	
2	2	2	4	2	4

Service Response PDU

MRC	SRC	Response code	Read data (for number of elements)
0 1	0 1		
2	2	4	0, 8, or 16

(1) Variable Type and Read Start Address

For details on variable types and read start addresses, see *SECTION 3 Communications Data for CompoWay/F and SYSWAY*.

(2) Bit Position

The E5CN does not support bit access. Fixed to "00."

(3) Number of Elements

Number of elements	Processing
0000	The read operation is not performed (read data is not appended to the service response PDU), and processing ends in "normal completion."
0001 to 0002	The read operation is performed, and processing ends in "normal completion."

(4) Response Code

Normal Completion

Response code	Name	Description
0000	Normal completion	No errors were found.

Error Occurred

Response code	Error name	Cause
1001	Command too long	The command is too long.
1002	Command too short	The command is too short.
1101	Area type error	The variable type is wrong.
1103	Start address out-of-range error	The read start address is out of range.

Response code	Error name	Cause
110B	Response too long	The number of elements is larger than "0002."
1100	Parameter error	Bit position is not "00."
2203	Operation error	EEPROM error

(5) Precautions

● Alarm Function

Even though alarms are not displayed on the Controller's display, they function normally in communications.

■ Write Variable Area

This service writes data to a variable area.

Service Request PDU

MRC	SRC	Variable type	Start write address	Bit position	Number of elements	Write Data (for number of elements)
0 1	0 2			0 0		
2	2	2	4	2	4	0, 8, or 16

Service Response PDU

MRC	SRC	Response code
0 1	0 2	
2	2	4

(1) Variable Type and Write Start Address

For details on variable types and write start addresses, see *SECTION 3 Communications Data for CompoWay/F and SYSWAY*.

(2) Bit Position

The E5CN does not support bit access. Fixed to "00."

(3) Number of Elements

Number of elements	Processing
0000	The write operation is not performed (do not append write data to the service request PDU) and processing ends in "normal completion."
0001 to 0002	The write operation is performed and processing ends in "normal completion."

(4) Response Code

Normal Completion

Response code	Name	Description
0000	Normal completion	No errors were found.

Error Occurred

Response code	Error name	Cause
1002	Command too short	The command is too short.
1101	Area type error	The variable type is wrong.
1103	Start address out-of-range error	Write start address is out of range.
1104	End address out-of-range error	The write end address (write start address + number of elements) exceeds the final address of the variable area.
1003	Number of elements/data mismatch	The number of data does not match the number of elements.
1100	Parameter error	<ul style="list-style-type: none"> • Bit position is not "00." • The write data is out of the setting range.
3003	Read-only error	Variable type "C0" was written to.
2203	Operation error	<ul style="list-style-type: none"> • The "communications writing" parameter is set to "OFF" (disabled). • Write operation was performed on the parameters from setup area 0 to setup area 1. • Write operation was performed on a protected parameter other than in the protect level. • AT (auto-tuning) was in progress.* • EEPROM error

* For details on AT (auto-tuning), refer to the separate *User's Manuals*.

(5) Precautions

● Alarm Function

Even though alarms are not displayed on the Controller's display, they function normally in communications.

■ Read Controller Attributes

This service reads the model number and communications buffer size.

Service Request PDU

MRC	SRC
0 5	0 3
2	2

Service Response PDU

MRC	SRC	Response code	Model No.	Buffer size
0 5	0 3			0 0 2 8
2	2	4	10	4

(1) Model Number

The model number is expressed in 10-byte ASCII. When 10 bytes are not required, pad the remaining bytes with spaces.

Example: The following model number is used for the E5CN-Q2HH03T (voltage output, two alarm outputs, two heater burnout detection inputs, communications functions, and multiple TC/Pt inputs).

e	5	c	n	-	Q	2	H	H	O
---	---	---	---	---	---	---	---	---	---

(2) Buffer Size

The communications buffer size is expressed in 2-byte hexadecimal, and read after being converted to 4-byte ASCII.

Buffer size: 40 bytes (= H'0028)

(3) Response Code

Normal Completion

Response code	Name	Description
0000	Normal completion	No errors were found.

Error Occurred

Response code	Name	Description
1001	Command too long	The command is too long.
2203	Operation error	EEPROM error

■ Read Controller Status

This service reads the operating status and error status.

Service Request PDU

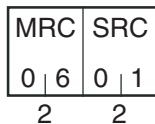

Service Response PDU

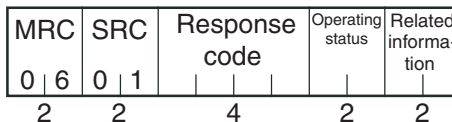

(1) Operating Status

Operating status	Description
00	Control is being carried out (error has not occurred in setup area 0 and the Controller is running).
01	Control is not being carried out (state other than above).

(2) Related Information

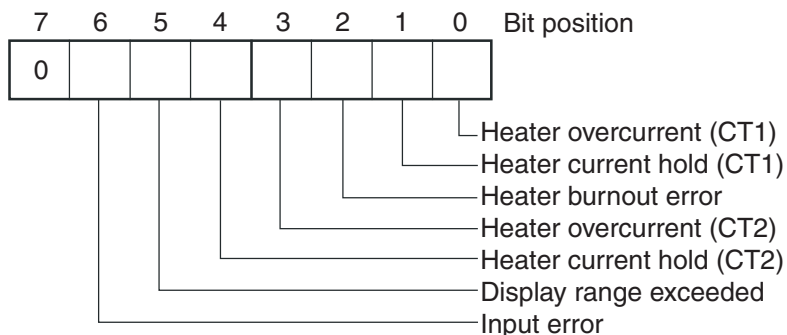

(3) Response Code

Normal Completion

Response code	Name	Description
0000	Normal completion	No errors were found.

Error Occurred

Response code	Name	Description
1001	Command too long	The command is too long.
2203	Operation error	EEPROM error

■ Echoback Test

This service performs an echoback test.

Service Request PDU

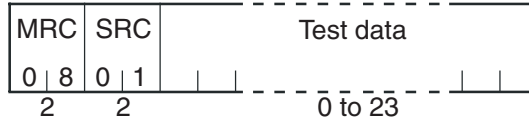

Service Response PDU

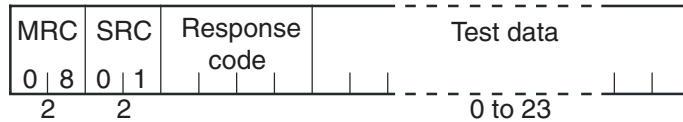

(1) Test Data

Set between 0 and 23 bytes of user-defined test data.

Set a value for the test data within the ranges shown below according to the communications data length.

Communications data length	Test Data
8 bits	ASCII data: H'20 to H'7E or H'A1 to H'FE
7 bits	ASCII data: H'20 to H'7E

Do not set the value H'40. No response will be returned.

(2) Response Code

Normal Completion

Response code	Name	Description
0000	Normal completion	No errors were found.

Error Occurred

Response code	Name	Description
1001	Command too long	The command is too long.
2203	Operation error	EEPROM error

■ Operation Command

This service performs operations such as run/stop, communications writing, write mode, save RAM data, AT (auto-tuning) execution/cancel, multi-SP, move protect level, move to setup area 1, and software reset.

Service Request PDU

MRC	SRC	Com- mand code	Related informa- tion
3 0	0 5		
2	2	2	2

Service Response PDU

MRC	SRC	Response code
3 0	0 5	
2	2	4

(1) Command Code and Related Information

Command code	Command content	Related Information
00	Communications writing	00: OFF (disabled) 01: ON (enabled)
01	RUN/STOP	00: Run 01: Stop
02	Multi-SP	00: Set point 0 01: Set point 1 02: Set point 2 03: Set point 3
03	AT execute/cancel	00: Cancel 01: AT execute
04	Write mode	00: Backup 01: RAM
05	Save RAM data	00
06	Software reset (See note.)	00
07	Move to setup area 1	00
08	Move to protect level	00
09	Auto/manual switch	00: Automatic mode 01: Manual mode
0B	Parameter initialization	00: Initialize to defaults 01: Initial settings service values
11	Program start	00: Reset 01: Start

Note: No response will be returned when a software reset is carried out.

(2) Response Code

Normal Completion

Response code	Name	Description
0000	Normal completion	No errors were found.

Error Occurred

Response code	Error name	Cause
1001	Command too long	The command is too long.
1002	Command too short	The command is too short.
1100	Parameter error	Command code and related information are wrong.
2203	Operation error	<ul style="list-style-type: none"> • The “communications writing” parameter is set to “OFF” (disabled). The command is received regardless of the “communications writing” parameter setting (ON/OFF). • Processing could not be performed. For details, see (3) <i>Operation Commands and Precautions</i> below. • EEPROM error

(3) Operation Commands and Precautions

● Communications Writing

Set the “communications writing” parameter to “ON: enabled” or “OFF: disabled” with the related information setting. The setting can be accepted in both setup area 0 and setup area 1.

● RUN/STOP

Set control to “run” or “stop” with the related information setting. The setting can be accepted in both setup area 0 and setup area 1.

● Multi-SP

Set four set points beforehand in the adjustment level so that you can switch to a desired set point. The setting can be accepted in both setup area 0 and setup area 1.

● AT Execute/Cancel

Set AT (auto-tuning) to “execute” or “cancel” with the related information setting. This command can be accepted in setup area 0 only. An “operation error” will be generated in the following instances:

- When the “run/stop” parameter is set to “stop”
- When the command is executed in “setup area 1”
- When ON/OFF control is being used

● Write Mode

Set either the backup mode or RAM write mode with the related information setting. The setting can be accepted in both setup area 0 and setup area 1.

Write mode	Description
Backup mode	The data is written to EEPROM when the parameters in the operation/adjustment levels (excluding read-only parameters) are written by communications.
RAM write mode	The data is not written to EEPROM when the parameters in the operation/adjustment levels (excluding read-only parameters) are written by communications. Parameters can be changed by operating the keys on the front panel of the controller.

- When the mode is switched from RAM write mode to backup mode, the parameters in the operation/adjustment levels (excluding read-only parameters) are written to EEPROM.
- The RAM write mode is enabled only when the “communications writing” parameter is set to “ON” (enabled). Consequently, when the “communications writing” parameter setting is changed to “OFF” (disabled), the parameters in the operation/adjustment levels (excluding read-only parameters) are written to EEPROM even if the mode is set to RAM write mode.

● Save RAM Data

This command writes the parameters in the operation/adjustment levels (excluding read-only parameters) to EEPROM. The setting can be accepted in both setup area 0 and setup area 1.

● Software Reset

Restarts processing from the point when power is turned ON. The setting can be accepted in both setup area 0 and setup area 1. No response will be returned for this operation command.

● Move to Setup Area 1

This command moves to “setup area 1” and can be accepted at both setup areas 0 and 1. If the “initial setup/communications protection” is set to “2,” an “operation error” will be generated, and the move to setup area 1 will be prohibited.

When this move is carried out from setup area 0, the display indicates the “input type” in the “initial setting level.” When this operation command is executed in setup area 1, the display will not change.

◆ Moving to Setup Area 1 in Manual Mode

When this operation command is issued in manual mode, an “operation error” will be generated, and the move to setup area 1 will be prohibited.

● **Move to Protect Level**

This command moves to the “protect level” and can be accepted only in setup area 0. When this command is issued in setup area 1, an “operation error” will be generated, and the move to the protect level will be prohibited.

◆ **Moving to Protect Level in Manual Mode**

When this operation command is issued in manual mode, an “operation error” will be generated, and the move to the protect level will be prohibited.

● **Auto/Manual Switch**

This operation command switches the mode to manual mode or automatic mode, based on the related information setting. This command can be accepted in setup area 0 only. An “operation error” will be generated in the following instances:

- When the command is executed in “setup area 1”
- When auto/manual switching is disabled (not displayed)

When the Controller is switched to manual mode, the “manual manipulated variable” will be displayed. When the Controller is switched from manual mode to automatic mode, the operation level’s first parameter will be displayed. When the Controller is switched to manual mode while already in manual mode, the command will be completed normally and the display will not change (the contents will not be refreshed).

◆ **Writing Auto/Manual Status in EEPROM**

The write mode determines whether the auto/manual status is written to EEPROM.

Write mode	Description
Backup mode	When the auto/manual mode is switched by communications, the auto/manual status is written to EEPROM.
RAM write mode	When the auto/manual mode is switched by communications, the auto/manual status is not written to EEPROM. The status can be written with the Controller key operation.

* When the auto/manual mode is switched with an operation command through communications and the Controller is in RAM write mode, the auto/manual status is not stored in EEPROM. Consequently, if the Controller is restarted by performing a software reset or turning the power OFF and ON again, the auto/manual mode is set to the last saved status.

◆ Switching to Manual Mode during Auto-tuning

If the mode is switched during auto-tuning (AT), the AT will be cancelled and the Controller will be switched to manual mode.

● Parameter Initialization

The present settings are returned to the default values and written to EEPROM. This command can be accepted in setup area 1 only. When this command is issued in setup area 0, an “operation error” will be generated.

The set values that are set during initialization depend on the command’s related information setting, as shown in the following table.

Related information	Explanation (initialization values)
00	Default initialization values (See <i>SECTION 3 Communications Data for CompoWay/F and SYSWAY</i> for details.) (These settings are the same as the ones used when “FACT” is selected for the setting data’s set value initialization.)
01	Values set with the initial values setting service (These settings are the same as the ones used when “USER” is selected for the setting data’s set value initialization.) If the initial values have not been set yet with the initial values setting service, the default initial values will be set.

● Program Start

The simple program function can be reset/started with the related information setting. The setting can be accepted in both setup area 0 and setup area 1. An operation error will be generated if program start has been set in the event input.

2.4 Response Code List

Normal Completion

Response code	Name	Description	Error detection priority
0000	Normal completion	No errors were found.	None

Error Occurred

Response code	Name	Description	Error detection priority
0401	Unsupported command	The service function for the relevant command is not supported.	1
1001	Command too long	The command is too long.	2
1002	Command too short	The command is too short.	3
1101	Area type error	Wrong variable type	4
1103	Start address out-of-range error	The read/write start address is out of range.	5
1104	End address out-of-range error	The write end address (write start address + number of elements) exceeds the final address of the variable area.	6
1003	Number of elements/data mismatch	The amount of data does not match the number of elements.	7
110B	Response too long	The response exceeds the communications buffer size (when the number of elements is larger than 0002).	8
1100	Parameter error	<ul style="list-style-type: none"> • Bit position is not "00." • The write data is out of the setting range. • The command code or related information in the operation command is wrong. 	9
3003	Read-only error	Variable type "C0" was written to.	10
2203	Operation error	<ul style="list-style-type: none"> • The "communications writing" parameter is set to "OFF" (disabled). • Write operation was performed on the parameters from setup area 0 to setup area 1. • Write operation was performed on a protected parameter other than in the protect level. • Writing was carried out during AT execution. • Processing is not possible by operation command. • EEPROM error 	11

SECTION 3

Communications Data for CompoWay/F and SYSWAY

This section lists the details of the communications data in the CompoWay/F and SYSWAY communications protocols.

3.1	Variable Area (Setting Range) List	3-2
3.2	Status.....	3-15

3.1 Variable Area (Setting Range) List

The following table lists the variable areas. Items expressed in hexadecimal in the “Set (monitor) value” column are the setting range for CompoWay/F communications. The values in parentheses are the actual setting range. Use the values in parentheses as the setting range for SYSWAY communications. When there is a section reference for a setting item, refer to that reference for details.

Variable type	Address	Parameter name	Setting (monitor) value	Level
C0	0000	PV	Temperature: Use the specified range for each sensor. Analog: Scaling lower limit –5% FS to Scaling upper limit +5% FS	Operating
C0	0001	Status (See note 1.)	See 3.2 <i>Status</i> for details.	
C0	0002	Internal set point (See note 1.)	SP lower limit to SP upper limit	
C0	0003	Heater current 1 value monitor	H'00000000 to H'00000226 (0.0 to 55.0)	
C0	0004	MV monitor (heating)	Standard: H'FFFFFFCE to H'0000041A (–5.0 to 105.0) Heating and cooling: H'00000000 to H'0000041A (0.0 to 105.0)	
C0	0005	MV monitor (cooling)	H'00000000 to H'0000041A (0.0 to 105.0)	
C0	0006	Heater current value 2 monitor	H'00000000 to H'00000226 (0.0 to 55.0)	
C0	0007	Leakage current value 1 monitor	H'00000000 to H'00000226 (0.0 to 55.0)	
C0	0008	Leakage current value 2 monitor	H'00000000 to H'00000226 (0.0 to 55.0)	
C0	0009	Soak time remain monitor	H'00000000 to H'0000270F (0 to 9999)	

Variable type	Address	Parameter name	Setting (monitor) value	Level
C1	0000	Operation/adjustment protect	H'00000000 (0): No restrictions in operation and adjustment levels H'00000001 (1): Move to adjustment level is prohibited. H'00000002 (2): Display and change of only "PV" and "PV/SP" parameters is allowed. H'00000003 (3): Display of only "PV" and "PV/SP" parameters is allowed.	Protect
C1	0001	Initial setting/communications protect	H'00000000 (0): Move to initial setting/communications setting level is allowed. (Move to advanced function setting level is displayed.) H'00000001 (1): Move to initial setting/communications setting level is allowed. (Move to advanced function setting level is not displayed.) H'00000002 (2): Move to initial setting/communications setting level is prohibited.	
C1	0002	Setup change protection	H'00000000 (0): OFF (Changing of setup on Controller display is allowed.) H'00000001 (1): ON (Changing of setup on Controller display is prohibited.)	
C1	0003	Set point	SP lower limit to SP upper limit	Operating
C1	0004	Alarm value 1	H'FFFFFF831 to H'0000270F (-1999 to 9999)	
C1	0005	Upper-limit alarm 1	H'FFFFFF831 to H'0000270F (-1999 to 9999)	
C1	0006	Lower-limit alarm 1	H'FFFFFF831 to H'0000270F (-1999 to 9999)	
C1	0007	Alarm value 2	H'FFFFFF831 to H'0000270F (-1999 to 9999)	
C1	0008	Upper-limit alarm 2	H'FFFFFF831 to H'0000270F (-1999 to 9999)	
C1	0009	Lower-limit alarm 2	H'FFFFFF831 to H'0000270F (-1999 to 9999)	
C1	000A	Alarm value 3 (See note 2.)	H'FFFFFF831 to H'0000270F (-1999 to 9999)	
C1	000B	Upper-limit alarm value 3 (See note 2.)	H'FFFFFF831 to H'0000270F (-1999 to 9999)	
C1	000C	Lower-limit alarm value 3 (See note 2.)	H'FFFFFF831 to H'0000270F (-1999 to 9999)	

Variable type	Address	Parameter name	Setting (monitor) value	Level
C1	000D	Heater burnout 1 detection	H'00000000 to H'000001F4 (0.0 to 50.0)	Adjustment
C1	000E	Set point 0	SP lower limit to SP upper limit	
C1	000F	Set point 1	SP lower limit to SP upper limit	
C1	0010	Set point 2	SP lower limit to SP upper limit	
C1	0011	Set point 3	SP lower limit to SP upper limit	
C1	0012	Temperature input shift value	H'FFFFFF831 to H'0000270F (-199.9 to 999.9)	
C1	0013	Upper-limit temperature input shift value	H'FFFFFF831 to H'0000270F (-199.9 to 999.9)	
C1	0014	Lower-limit temperature input shift value	H'FFFFFF831 to H'0000270F (-199.9 to 999.9)	
C1	0015	Proportional band	H'00000001 to H'0000270F (0.1 to 999.9)	
C1	0016	Integral time	H'00000000 to H'00000F9F (0 to 3999)	
C1	0017	Derivative time	H'00000000 to H'00000F9F (0 to 3999) (Range when RT is "OFF") H'00000000 to H'0000270F (0.0 to 999.9) (Range when RT is "ON")	
C1	0018	Cooling coefficient	H'00000001 to H'0000270F (0.01 to 99.99)	

Variable type	Address	Parameter name	Setting (monitor) value	Level
C1	0019	Dead band	H'FFFFFF831 to H'0000270F (-199.9 to 999.9 for TC/Pt multi-input models) (-19.9 to 99.99 for Analog input models)	Adjustment
C1	001A	Manual reset value	H'00000000 to H'000003E8 (0.0 to 100.0)	
C1	001B	Hysteresis (heating)	H'00000001 to H'0000270F (0.1 to 999.9 for TC/Pt multi-input models) (0.01 to 99.99 for Analog input models)	
C1	001C	Hysteresis (cooling)	H'00000001 to H'0000270F (0.1 to 999.9 for TC/Pt multi-input models) (0.01 to 99.99 for Analog input models)	
C1	001D	Heater burnout 2 detection	H'00000000 to H'000001F4 (0.0 to 50.0)	
C1	001E	HS alarm 1	H'00000000 to H'000001F4 (0.0 to 50.0)	
C1	001F	HS alarm 2	H'00000000 to H'000001F4 (0.0 to 50.0)	
C1	0020	Soak time	H'00000001 to H'0000270F (1 to 9999)	
C1	0021	Wait band	H'00000000 (0): OFF H'00000001 to H'0000270F (0.1 to 999.9 for TC/Pt multi-input models) (0.01 to 99.99 for Analog input models)	
C1	0022	MV at stop	Standard: H'FFFFFFFCE to H'0000041A (-5.0 to 105.0) Heating and cooling: H'FFFFFFBE6 to H'0000041A (-105.0 to 105.0)	
C1	0023	MV at PV error	Standard: H'FFFFFFFCE to H'0000041A (-5.0 to 105.0) Heating and cooling: H'FFFFFFBE6 to H'0000041A (-105.0 to 105.0)	

Note: The alarm function can also be used in Controllers without alarm output terminals. In this case, confirm alarm occurrences via the status data.

Variable type	Address	Parameter name	Setting (monitor) value	Level
C1	0024	Manual manipulated variable	Standard: H'FFFFFFCE to H'0000041A (–5.0 to 105.0) Heating and cooling: H'FFFFFFBE6 to H'0000041A (–105.0 to 105.0)	Manual Control
C1	0025	SP ramp set value	H'00000000 (0): OFF H'00000001 to H'0000270F (1 to 9999)	Adjustment
C1	0026	MV upper limit	Standard: MV lower limit + 0.1 to H'0000041A (MV lower limit + 0.1 to 105.0) Heating and cooling: H'00000000 to H'0000041A (0.0 to 105.0)	
C1	0027	MV lower limit	Standard: H'FFFFFFCE to MV upper limit – 0.1 (–5.0 to MV upper limit – 0.1) Heating and cooling: H'FFFFFFBE6 to H'00000000 (–105.0 to 0.0)	
C1	0028	Move protect level	H'FFFFFF831 to H'0000270F (–1999 to 9999)	Protect
C1	0029	Password to move to protect level	H'FFFFFF831 to H'0000270F (–1999 to 9999) (Can only be set. The monitor value is always H'00000000.)	
C1	002A	Parameter mask enable	H'00000000 (0): OFF H'00000001 (1): ON	
C3	0000	Input type (TC/Pt multi-input models) (See note.)	H'00000000 (0): Pt (–200 to 850°C/–300 to 1500°F) H'00000001 (1): Pt (–199.9 to 500.0°C/–199.9 to 900.0°F) H'00000002 (2): Pt (0.0 to 100.0°C/0.0 to 210.0°F) H'00000003 (3): JPt (–199.9 to 500.0°C/–199.9 to 900.0°F) H'00000004 (4): JPt (0.0 to 100.0°C/0.0 to 210.0°F) H'00000005 (5): K (–200 to 1300°C/–300 to 2300°F) H'00000006 (6): K (–20.0 to 500.0°C/0.0 to 900.0°F) H'00000007 (7): J (–100 to 850°C/–100 to 1500°F) H'00000008 (8): J (–20.0 to 400.0°C/0.0 to 750.0°F) H'00000009 (9): T (–200 to 400°C/–300 to 700°F) H'0000000A (10): T (–199.9 to 400.0°C/–199.9 to 700.0°F) H'0000000B (11): E (0 to 600°C/0 to 1100°F) H'0000000C (12): L (–100 to 850°C/–100 to 1500°F) H'0000000D (13): U (–200 to 400°C/–300 to 700°F) H'0000000E (14): U (–199.9 to 400.0°C/–199.9 to 700.0°F) H'0000000F (15): N (–200 to 1300°C/–300 to 2300°F) H'00000010 (16): R (0 to 1700°C/0 to 3000°F) H'00000011 (17): S (0 to 1700°C/0 to 3000°F) H'00000012 (18): B (100 to 1800°C/300 to 3200°F) H'00000013 (19): Infrared temperature sensor (K 140°F/60°C) H'00000014 (20): Infrared temperature sensor (K 240°F/120°C) H'00000015 (21): Infrared temperature sensor (K 280°F/140°C) H'00000016 (22): Infrared temperature sensor (K 440°F/220°C) H'00000017 (23): 0 to 50 mV	Initial setting

Variable type	Address	Parameter name	Setting (monitor) value	Level
C3	0000	Input type (analog input models) (See note.)	H'00000000 (0): 4 to 20 mA H'00000001 (1): 0 to 20 mA H'00000002 (2): 1 to 5 V H'00000003 (3): 0 to 5 V H'00000004 (4): 0 to 10 V	Initial setting
C3	0001	Scaling upper limit	Scaling lower limit + 1 to H'0000270F (scaling lower limit + 1 to 9,999)	
C3	0002	Scaling lower limit	H'FFFFFF831 to Scaling upper limit – 1 (–1999 to Scaling upper limit – 1)	
C3	0003	Decimal point position (TC/Pt multi-input models)	H'00000000 to 00000001 (0 to 1)	
		Decimal point position (analog input models)	H'00000000 to 00000003 (0 to 3)	
C3	0004	Temperature unit	H'00000000 (0): °C H'00000001 (1): °F	
C3	0005	SP upper limit	The range of values (without decimal point) is as follows: Temperature: SP lower limit + 1 to Input range upper limit Analog: SP lower limit + 1 to Scaling upper limit	
C3	0006	SP lower limit	The range of values (without decimal point) is as follows: Temperature: Input range lower limit to SP upper limit – 1 Analog: Scaling lower limit to SP upper limit – 1	
C3	0007	PID/OnOff	H'00000000 (0): ON/OFF H'00000001 (1): 2 degrees of freedom PID control	
C3	0008	Standard or heating and cooling	H'00000000 (0): Standard H'00000001 (1): Heating and cooling	
C3	0009	ST	H'00000000 (0): OFF H'00000001 (1): ON	

Note: The input type can be selected to match the connected sensor.

There are two input type specifications: Thermocouple/Resistance thermometer input and Analog input.

Variable type	Address	Parameter name	Setting (monitor) value	Level
C3	000A	Control period (heat)	H'00000000 (0): 0.5 H'00000001 to H'00000063 (1 to 99)	Initial setting
C3	000B	Control period (cool)	H'00000000 (0): 0.5 H'00000001 to H'00000063 (1 to 99)	
C3	000C	Direct/reverse operation	H'00000000 (0): Reverse operation H'00000001 (1): Direct operation	
C3	000D	Alarm 1 type	H'00000000 (0): Alarm function OFF H'00000001 (1): Upper and lower-limit alarm H'00000002 (2): Upper-limit alarm H'00000003 (3): Lower-limit alarm H'00000004 (4): Upper and lower-limit range alarm H'00000005 (5): Upper and lower-limit alarm with standby sequence H'00000006 (6): Upper-limit alarm with standby sequence H'00000007 (7): Lower-limit alarm with standby sequence H'00000008 (8): Absolute-value upper-limit alarm H'00000009 (9): Absolute-value lower-limit alarm H'0000000A (10): Absolute-value upper-limit alarm with standby sequence H'0000000B (11): Absolute-value lower-limit alarm with standby sequence H'0000000C (12): LBA (Loop Burnout Alarm)	
C3	000E	Alarm 2 type	H'00000000 (0): Alarm function OFF H'00000001 (1): Upper and lower-limit alarm H'00000002 (2): Upper-limit alarm H'00000003 (3): Lower-limit alarm H'00000004 (4): Upper and lower-limit range alarm H'00000005 (5): Upper and lower-limit alarm with standby sequence H'00000006 (6): Upper-limit alarm with standby sequence H'00000007 (7): Lower-limit alarm with standby sequence H'00000008 (8): Absolute-value upper-limit alarm H'00000009 (9): Absolute-value lower-limit alarm H'0000000A (10): Absolute-value upper-limit alarm with standby sequence H'0000000B (11): Absolute-value lower-limit alarm with standby sequence	
C3	000F	Alarm 3 type (See note 2.)	Same settings as the alarm 2 type	

Variable type	Address	Parameter name	Setting (monitor) value	Level
C3	0010	Communications unit number (See note 3.)	H'00000000 to H'00000063 (0 to 99)	Communications setting
C3	0011	Communications baud rate (See note 3.)	H'00000000 (0): 1.2 H'00000001 (1): 2.4 H'00000002 (2): 4.8 H'00000003 (3): 9.6 H'00000004 (4): 19.2 H'00000005 (5): 38.4	
C3	0012	Communications data length (See note 3.)	H'00000007 (7): 7 H'00000008 (8): 8	
C3	0013	Communications stop bits (See note 3.)	H'00000001 (1): 1 H'00000002 (2): 2	
C3	0014	Communications parity (See note 3.)	H'00000000 (0): None H'00000001 (1): Even H'00000002 (2): Odd	

Note: The alarm function can also be used in Controllers without alarm output terminals. In this case, confirm alarm occurrences via the status data.

Variable type	Address	Parameter name	Setting (monitor) value	Level
C3	0015	Number of multi-SP uses	H'00000000 (0): No multi-SP H'00000001 (1): 2SP H'00000002 (2): 4SP	Advanced function setting
C3	0016	Event input assignment 1	H'00000000 (0): None H'00000001 (1): RUN/STOP (Cannot be set if the "Number of multi-SP uses" is set to 1 or 2.) H'00000002 (2): Auto/Manual (Cannot be set if the "Number of multi-SP uses" is set to 1 or 2.) H'00000003 (3): Program Start (Cannot be set if the "Number of multi-SP uses" is set to 1 or 2.) (See note 6.)	
C3	0017	Event input assignment 2	H'00000000 (0): None H'00000001 (1): RUN/STOP (Cannot be set if the "Number of multi-SP uses" is set to 2.) H'00000002 (2): Auto/Manual (Cannot be set if the "Number of multi-SP uses" is set to 2.) H'00000003 (3): Program Start (Cannot be set if the "Number of multi-SP uses" is set to 2.) (See note 6.)	
C3	001A	Multi-SP usage	H'00000000 (0): OFF H'00000001 (1): ON	
C3	001B	SP ramp time unit	H'00000000 (0): EU/second H'00000001 (1): EU/minute	
C3	001C	SP ramp set value	H'00000000 (0): OFF H'00000001 to H'0000270F (1 to 9999)	
C3	001D	Standby sequence reset	H'00000000 (0): Condition A H'00000001 (1): Condition B	
C3	001E	Alarm 1 open in alarm	H'00000000 (0): Close in alarm H'00000001 (1): Open in alarm	
C3	001F	Alarm 1 hysteresis	H'00000001 to H'0000270F (0.1 to 999.9 for TC/Pt multi-input models) (0.01 to 99.99 for Analog input models)	
C3	0020	Alarm 2 open in alarm	H'00000000 (0): Close in alarm H'00000001 (1): Open in alarm	
C3	0021	Alarm 2 hysteresis	H'00000001 to H'0000270F (0.1 to 999.9 for TC/Pt multi-input models) (0.01 to 99.99 for Analog input models)	
C3	0022	Alarm 3 open in alarm (See note 2.)	H'00000000 (0): Close in alarm H'00000001 (1): Open in alarm	
C3	0023	Alarm 3 hysteresis (See note 2.)	H'00000001 to H'0000270F (0.1 to 999.9 for TC/Pt multi-input models) (0.01 to 99.99 for Analog input models)	
C3	0024	HB ON/OFF	H'00000000 (0): OFF H'00000001 (1): ON	
C3	0025	Heater burnout latch	H'00000000 (0): OFF H'00000001 (1): ON	

Variable type	Address	Parameter name	Setting (monitor) value	Level
C3	0026	Heater burnout hysteresis	H'00000001 to H'000001F4 (0.1 to 50.0)	Advanced function setting
C3	0027	ST stable range	H'00000001 to H'0000270F (0.1 to 999.9)	
C3	0028	α	H'00000000 to H'00000064 (0.00 to 1.00)	
C3	0029	MV upper limit	Standard: MV lower limit + 0.1 to H'0000041A (MV lower limit + 0.1 to 105.0) Heating and cooling: H'00000000 to H'0000041A (0.0 to 105.0)	
C3	002A	MV lower limit	Standard: H'FFFFFFCE to MV upper limit – 0.1 (–5.0 to MV upper limit – 0.1) Heating and cooling: H'FFFFFFBE6 to H'00000000 (–105.0 to 0.0)	
C3	002B	Input digital filter	H'00000000 to H'0000270F (0.0 to 999.9)	
C3	002C	Additional PV display	H'00000000 (0): OFF H'00000001 (1): ON	
C3	002D	MV display	H'00000000 (0): OFF (display of manipulated variable OFF) H'00000001 (1): ON (display of manipulated variable ON)	
C3	002E	Automatic display return time	H'00000000 (0): OFF H'00000001 to H'00000063 (1 to 99)	
C3	002F	Alarm 1 latch	H'00000000 (0): OFF H'00000001 (1): ON	
C3	0030	Alarm 2 latch	H'00000000 (0): OFF H'00000001 (1): ON	
C3	0031	Alarm 3 latch (See note 2.)	H'00000000 (0): OFF H'00000001 (1): ON	

Note: The alarm function can also be used in Controllers without alarm output terminals. In this case, confirm alarm occurrences via the status data.

Variable type	Address	Parameter name	Setting (monitor) value	Level
C3	0032	Protect level move time	H'00000001 to H'0000001E (1 to 30)	Advanced function setting
C3	0033	Input error output	H'00000000 (0): OFF H'00000001 (1): ON	
C3	0034	Cold junction compensation method	H'00000000 (0): OFF H'00000001 (1): ON	
C3	0035	MB command logic switching (See note 7.)	H'00000000 (0): OFF H'00000001 (1): ON	
C3	0036	PV change color	H'00000000 (0): ORG H'00000001 (1): RED H'00000002 (2): GRN H'00000003 (3): R-G H'00000004 (4): G-R H'00000005 (5): R-G.R H'00000006 (6): G-O.R H'00000007 (7): O-G.R	
C3	0037	PV stable band	H'00000001 to H'0000270F (0.1 to 999.9 for TC/Pt multi-input models) (0.01 to 99.99 for Analog input models)	
C3	0038	Alarm 1 ON delay	H'00000000 to H'000003E7 (0 to 999)	
C3	0039	Alarm 2 ON delay	H'00000000 to H'000003E7 (0 to 999)	
C3	003A	Alarm 3 ON delay (See note 2.)	H'00000000 to H'000003E7 (0 to 999)	
C3	003B	Alarm 1 OFF delay	H'00000000 to H'000003E7 (0 to 999)	
C3	003C	Alarm 2 OFF delay	H'00000000 to H'000003E7 (0 to 999)	
C3	003D	Alarm 3 OFF delay (See note 2.)	H'00000000 to H'000003E7 (0 to 999)	
C3	003E	Transfer output type	H'00000000 (0): OFF H'00000001 (1): Set point H'00000002 (2): Set point during SP ramp H'00000003 (3): PV H'00000004 (4): MV monitor (heating) H'00000005 (5): MV monitor (cooling)	
C3	003F	Transfer output upper limit	H'FFFFFF831 to H'0000270F (-1999 to 9999) (See note 4.)	
C3	0040	Transfer output lower limit	H'FFFFFF831 to H'0000270F (-1999 to 9999) (See note 4.)	
C3	0041	Linear current output	H'00000000 (0): 4 to 20 mA H'00000001 (1): 0 to 20 mA	
C3	0042	Input shift type	H'00000000 (0): 1-point shift H'00000001 (1): 2-point shift	
C3	0043	Output status during error	H'00000000 (0): 0 mA H'00000001 (1): MV at PV error	Advanced function setting

Variable type	Address	Parameter name	Setting (monitor) value	Level
C3	0044	Auto/manual switching display addition	H'00000000 (0): OFF H'00000001 (1): ON	Advanced function setting
C3	0045	RT	H'00000000 (0): OFF H'00000001 (1): ON	
C3	0046	HS alarm	H'00000000 (0): OFF H'00000001 (1): ON	
C3	0047	HS alarm latch	H'00000000 (0): OFF H'00000001 (1): ON	
C3	0048	HS alarm hysteresis	H'00000001 to H'000001F4 (0.1 to 50.0)	
C3	0049	LBA detection time	H'00000000 to H'0000270F (0 to 9999)	
C3	004A	LBA level	H'00000001 to H'0000270F (0.1 to 999.9 for TC/Pt multi-input models) (0.01 to 99.99 for Analog input models)	
C3	004B	LBA band	H'00000000 to H'0000270F (0.0 to 999.9 for TC/Pt multi-input models) (0.00 to 99.99 for Analog input models)	

Variable type	Address	Parameter name	Setting (monitor) value	Level	
C3	004C	Protocol Setting (See note 3.)	H'00000000 (0): CompoWay/F (SYSWAY) H'00000001 (1): Modbus	Commu- nications setting	
C3	004D	Send data wait time (See note 3.)	H'00000000 to H'00000063 (0 to 99)		
C3	004E	Control output 1 assignment	When control output 1 is a linear output: H'00000000 (0): Not assigned. H'00000001 (1): Control output (heating) H'00000002 (2): Control output (cooling) When control output 1 is a pulse output: H'00000000 (0): Not assigned. H'00000001 (1): Control output (heating) H'00000002 (2): Control output (cooling) H'00000003 (3): Alarm 1 H'00000004 (4): Alarm 2 H'00000005 (5): Alarm 3 H'00000006 (6): Program end output (See note 5.)	Advanced function setting	
C3	004F	Control output 2 assignment	H'00000000 (0): Not assigned. H'00000001 (1): Control output (heating) H'00000002 (2): Control output (cooling) H'00000003 (3): Alarm 1 H'00000004 (4): Alarm 2 H'00000005 (5): Alarm 3 H'00000006 (6): Program end output (See note 5.)		
C3	0050	Alarm 1 assignment	H'00000000 to H'00000006 (0 to 6) * Same settings as control output 2 assignments		
C3	0051	Alarm 2 assignment	H'00000000 to H'00000006 (0 to 6) * Same settings as control output 2 assignments		
C3	0052	Display character switch	H'00000000 (0): OFF H'00000001 (1): ON		
C3	0053	Program pattern	H'00000000 (0): OFF H'00000001 (1): STOP H'00000002 (2): CONT		Initial set- ting
C3	0054	Soak time units	H'00000000 (0): Minutes H'00000001 (1): Hours		Advanced function setting
C3	0055	Alarm SP selection	H'00000000 (0): Set point during SP ramp H'00000001 (1): Set point		

Note 1. Not displayed on the Controller display.

Note 2. The parameter will not be shown on the Controller display when alarm 3 is not assigned to an output.

Note 3. After communications parameters have been changed, they are enabled by resetting the Controller.

Note 4. The setting (monitor) range depends on the “transfer output type” setting. (See the setting data list for details.)

Note 5. The program end output can be set when the “program pattern” is not set to 0 (OFF).

Note 6. Program start can be set when the “program pattern” is not set to 0 (OFF).

Note 7. The logic is switched only in the MB command (SYSWAY). The logic of CompoWay/F operation command code 00 (communications writing) is not influenced.

3.2 Status

The figure below shows the structure of the status data.

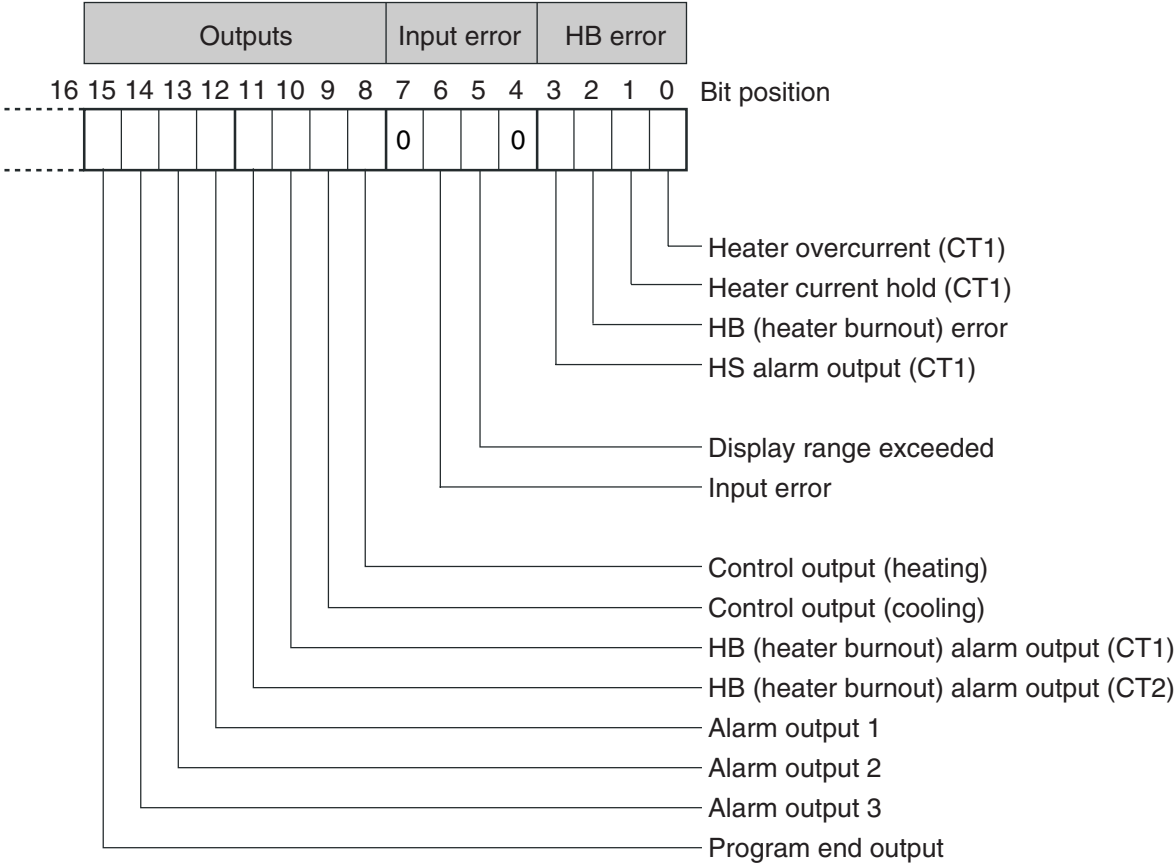

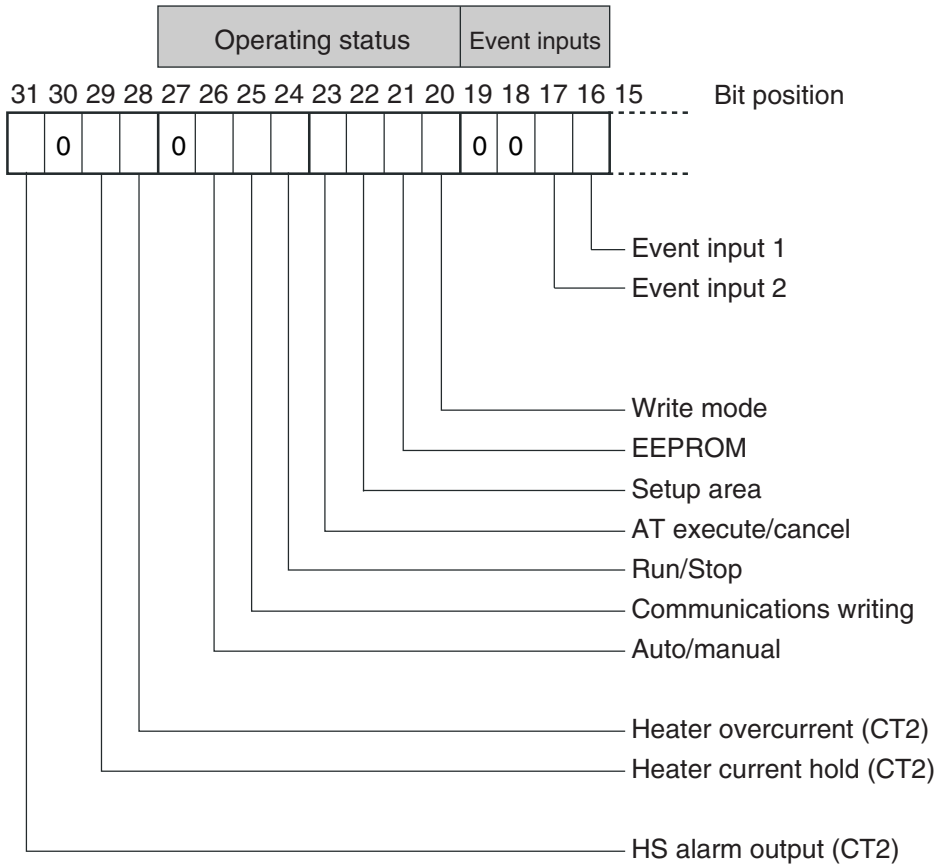

Bit position	Status	Bit Description	
		0	1
0	Heater overcurrent (CT1)	Not generated	Generated
1	Heater current hold (CT1) (See note 1.)	Update	Hold
2	HB (heater burnout) error	Not generated	Generated
3	HS alarm output (CT1)	OFF	ON
4	Spare	OFF	---
5	Display range exceeded	Not generated	Generated
6	Input error	Not generated	Generated
7	Spare	OFF	---
8	Control output (heating)	OFF	ON
9	Control output (cooling)	OFF	ON
10	HB (heater burnout) alarm output (CT1)	OFF	ON
11	HB (heater burnout) alarm output (CT2)	OFF	ON
12	Alarm output 1	OFF	ON
13	Alarm output 2	OFF	ON
14	Alarm output 3	OFF	ON
15	Program end output	OFF	ON
16	Event input 1	OFF	ON
17	Event input 2	OFF	ON
18	Spare	OFF	---
19	Spare	OFF	---
20	Write mode	Backup mode	RAM write mode
21	EEPROM	RAM = EEPROM	RAM ≠ EEPROM
22	Setup area	Setup area 0	Setup area 1
23	AT execute/cancel	AT canceled	AT execution in progress
24	RUN/STOP	Run	Stop
25	Communications writing	OFF (disabled)	ON (enabled)
26	Auto/manual switch	Automatic mode	Manual mode
27	Spare	OFF	---
28	Heater overcurrent (CT2)	Not generated	Generated
29	Heater current hold (CT2) (See note 1.)	Update	Hold
30	Spare	OFF	---
31	HS alarm output (CT2)	OFF	ON

Note 1. When the control output ON time is less than 190 ms, the bit is set to “1” and the heater current is held at the last current value.

Note 2. “Spare” bits are always OFF.

Note 3. When read in setup area 1, the status of the bits will be as follows:

- Overcurrent: Last value held
- HB error: Last value held
- Input error: Last value held
- HB and HS outputs: Cleared
- Program end output: Cleared
- Current hold: Last value held
- Display range exceeded: Last value held
- Heating and cooling outputs: Cleared
- Alarm outputs: Cleared

SECTION 4

SYSWAY (E5□J and E5□X Format) Communications Procedures

These communications procedures are supported to provide compatibility with the E5□J and E5□X Temperature Controllers. When using a new system, we recommend using CompoWay/F communications.

4.1	Data Format.....	4-2
	Command Frame Format	4-2
	FCS Calculation Example	4-2
	Response Frame	4-3
	Communications Data	4-3
	SYSWAY Command Lists	4-4
4.2	Command Descriptions	4-5
	Read Process Value	4-5
	Write Set Values	4-6
	Read Set Values and MV Monitor	4-7
	Select Communications Writing.....	4-9

4.1 Data Format

Command Frame Format

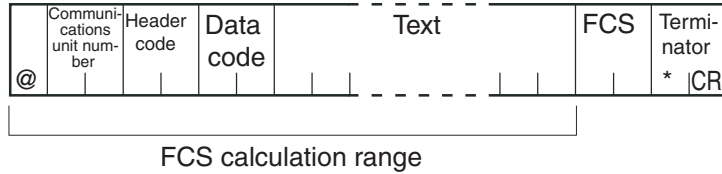

@	The @ character (ASCII H'40) indicates the start of block format.
Communications unit number	A number within the range 0 to 99 can be set in BCD. No response will be returned to a node with a number outside of this range.
Header code	This is a 2-character alphabetic code that indicates the command type.
Data code	Set "02" only when reading and writing alarm value 2. Otherwise, set "01."
Text	This area contains read values, write values, or status data. The data depends on the command.
FCS	This is the Frame Check Sequence. The FCS (Frame Check Sequence) is calculated by taking the exclusive OR of all characters from the @ character to the last text character and converting the result to ASCII characters.
Terminator	Indicates the end of the block format. The terminator is composed of "*" and CR (Character Return = H'0D).

FCS Calculation Example

The FCS (Frame Check Sequence) is calculated by taking the exclusive OR of all characters from the @ character to the last text character and converting that 8-bit result into two ASCII characters.

Start character	Communication unit number	Header code	Data code	FCS
@ (40H)	0 (30H) 0 (30H)	R (52H) X (58H)	0 (30H) 1 (31H)	4 (34H) B (42H)

$$\text{FCS} = 40\text{H} \oplus 30\text{H} \oplus 30\text{H} \oplus 52\text{H} \oplus 58\text{H} \oplus 30\text{H} \oplus 31\text{H} = 4\text{BH}$$

The calculation result (4B hex) is converted to ASCII and written to the FCS bytes.

4 → 34H

B → 42H

The ⊕ symbols indicate XOR (exclusive OR) operations.

■ Response Frame



End code	Name	Description	Priority
10	Parity error	The sum total of bits whose received data is "1" does not match the set value of "communications parity."	1
11	Framing error	Stop bit is "0."	2
12	Overrun error	An attempt was made to transfer new data when the reception data buffer was already full.	3
13	FCS error	The calculated FCS value is different from the received FCS value.	4
IC*	Undefined error	The header code of the command cannot be interpreted.	5
14	Format error	The command length is incorrect.	6
0D	Non-executable command	<ul style="list-style-type: none"> The set value was written when the "communications writing" parameter was set to "OFF" (disabled). The set value was written during AT execution. 	7
15	Undefined data value	<ul style="list-style-type: none"> The write data is either outside the setting range or not a numerical value. The data code is either outside the setting range or not a numerical value. 	8
00	Normal completion	The command ended normally without error.	---

* The response format is unusual when an "Undefined error" has occurred due to an invalid command header code. The error code will be contained in the response's header code rather than the end code. See the following diagram for details.

Response Format when an "Undefined Error" Occurred

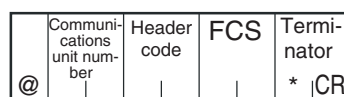

■ Communications Data

Communica- tions Format	Setting (monitor) value	Negative values	Decimal Point
SYSWAY	Four digits (decimal)	If the leftmost digit is "-1," it is set to "A." Example: -1999 → A999 If the leftmost digit is "-", it is set to "F." Example: -10 → F010	The decimal point is removed. Example: 105.0 → 1050

■ SYSWAY Command Lists

Category	Header code	Data code	Command	R/W	Data length	Remarks
Selecting Communications Writing	MB	01	Select communications writing	Write	4B	
Write mode selection	ME	01	Select backup mode	Write	None	
	MA	01	Select RAM write mode			
Save operation/adjustment set value	MW	01	Save operation/adjustment set value			
Writing set values	WS	01	Write set point	Write	4B	
	W%	01	Write alarm value 1			
	W%	02	Write alarm value 2			
	WB	01	Write proportional band			
	WN	01	Write integral time			
	WV	01	Write derivative time			
	WI	01	Write temperature input shift values			
WW	01	Write heater burnout detection				
Read set value and manipulated variable monitor	RS	01	Read set point	Read	4B	
	R%	01	Write alarm value 1			
	R%	02	Write alarm value 2			
	RB	01	Read proportional band			
	RN	01	Write integral time			
	RV	01	Write derivative time			
	RI	01	Write temperature input shift values			
	RW	01	Write heater burnout detection			
RO	01	Read MV monitor				
Read SP upper and lower limit values	RL	01	Read SP upper and lower limit values	Read	8B	Read both upper/lower limit values at once
Read process value	RX	01	Read process value	Read	8B	See note 1.
Read the heater current monitor	RZ	01	Heater current value monitor	Read	8B	See note 2.
Read the initial status	RU	01	Read the initial status	Read	5B	See note 3.

- No commands will be accepted and no responses will be returned when a memory error (RAM error) has occurred or during initialization (until the process value is recognized after power is turned ON).
- When a write operation is performed while there is a memory error (EEPROM error), data will not be written and the command will end with “normal completion.” Read operations will be executed normally.

Note 1. The process value read range is the same as the input's display range.

Note 2. Status (last 4 bytes) Note 3. Status (first 2 bytes)

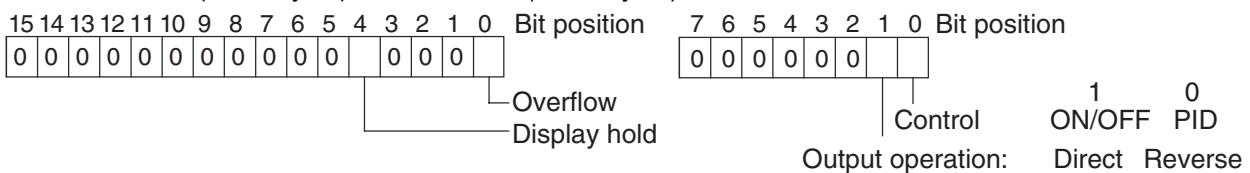

- Overflow: Set 1 when the heater current value is greater than 55.0 A.
- Display hold: Set 1 when the control output ON time is less than 190 ms. The previous heater current value is held.

4.2 Command Descriptions

■ Read Process Value

This command reads the process value and status.

Command

@	Communi- cations unit num- ber	Header code R X	Data code 0 R	FCS	Termi- nator * CR
---	---	-------------------------	-----------------------	-----	---------------------------

Response

@	Communi- cations unit num- ber	Header code R X	End code 0 R	PV	Status	FCS	Termi- nator * CR
---	---	-------------------------	----------------------	----	--------	-----	---------------------------

(1) PV

See *SECTION 3 Communications Data for CompoWay/F and SYSWAY*.

(2) Status

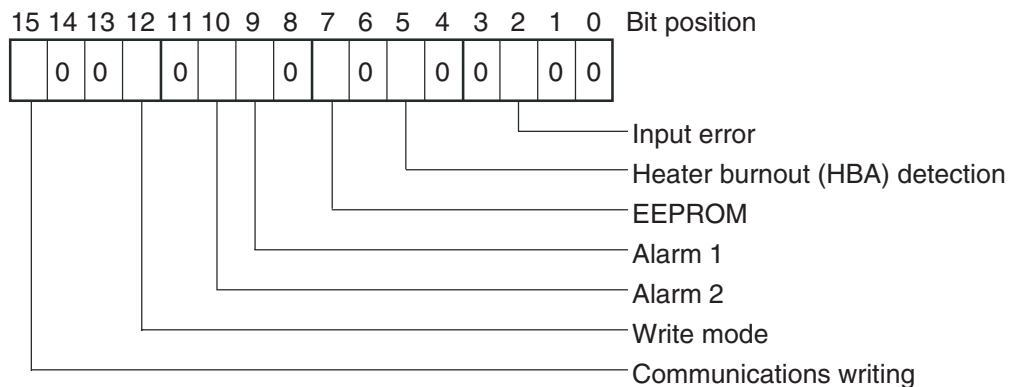

Item	Description	
	0	1
Input error	Not generated	Generated
Heater burnout detection	OFF or does not function	ON
EEPROM	RAM = EEPROM	RAM ≠ EEPROM
Alarm 1	OFF or does not function	ON
Alarm 2	OFF or does not function	ON
Write mode	Backup mode	RAM write mode
Communications writing	OFF (disabled) or does not function	ON (enabled)

(3) End Code

When the end code is "00," this indicates normal completion of the command. Otherwise, the command could not be processed. For details on end codes, see *Response Frame* on page 4-3.

(4) Precautions

- Even though alarms 1 and 2 are not displayed on the Controller display, they function normally in communications.
- When the Controller has moved to setting area 1, the previous status is held. “Setting area 1” is where the initial setting, communications setting, advanced function setting, and calibration levels are grouped together.

■ Write Set Values

This command writes the set point, alarm values 1 and 2, proportional band, integral time, derivative time, temperature input shift values, and heater burnout detection.

Command

@	Communi- cations unit num- ber	Header code	Data code	Write value	FCS	Termi- nator * CR
---	---	----------------	--------------	----------------	-----	--------------------------

Response

@	Communi- cations unit num- ber	Header code	End code	FCS	Termi- nator * CR
---	---	----------------	-------------	-----	--------------------------

(1) Header Code

Header code	Command
WS	Write set point
W%	Write alarm value 1/2
WB	Write proportional band
WN	Write integral time
WV	Write derivative time
WI	Write temperature input shift values
WW	Write heater burnout detection

(2) Data Code

Set the data code to “02” only when writing alarm value 2. In all other cases, set to “01.”

(3) Write Value

For details on the write value (set value) range, see *SECTION 3 Communications Data for CompoWay/F and SYSWAY*.

(4) Precautions

● Alarm Values 1 and 2

When the alarm 1 type is set to “upper and lower-limit alarm,” “upper and lower-limit range alarm,” or “upper and lower-limit alarm with standby sequence,” the alarm’s upper and lower limits are set indepen-

dently. The “alarm value 1” setting is disabled and the “alarm value upper limit 1” and “alarm value lower limit 1” settings are used as the alarm set values.

For this reason, when an “upper and lower-limit alarm” is set, write values are written by communications to “alarm value upper limit 1” and “alarm value lower limit 1” and not to “alarm value 1.” The same applies to “alarm 2 type.”

● Temperature Input Shift Value

When the 2-point shift method is used, the “temperature input shift value” is disabled and the “upper-limit temperature input shift value” and “lower-limit temperature input shift value” parameters are enabled as the temperature input shift set values. For this reason, write values are written to the “upper-limit temperature input shift value” and “lower-limit temperature input shift value” and not to the “temperature input shift value.”

The 2-point shift method will be used in the following cases:

- The “input type” is set to infrared temperature sensor.
- The “input type” is not set to infrared temperature sensor, but the “input shift type” is set to 2-point shift.

● Alarms

- Only alarms 1 and 2 are supported.
- Alarm 3 cannot be used.

● Heater Burnout Detection

Written to “heater burnout detection 1.” (The value is not written to “heater burnout 2 detection.”)

■ Read Set Values and MV Monitor

This command reads the set point, alarm values 1 and 2, proportional band, integral time, derivative time, temperature input shift values, heater burnout detection, and MV monitor.

Command

	Communi- cations unit num- ber	Header code	Data code	FCS	Termi- nator
@					* CR

Response

	Communi- cations unit num- ber	Header code	End code	Read value	FCS	Termi- nator
@						* CR

(1) Header Code

Header code	Command
RS	Read set point
R%	Read alarm value 1/2
RB	Read proportional band
RN	Read integral time
RV	Read derivative time
RI	Read input shift values
RW	Read temperature heater burn-out detection
RO	Read MV monitor

(2) Data Code

Set the data code to “02” only when writing alarm value 2. In all other cases, set to “01.”

(3) Read Value

For details on the read value ranges, see *SECTION 3 Communications Data for CompoWay/F and SYSWAY*.

(4) Precautions

● Alarm Values 1 and 2

When the alarm 1 type is set to “upper and lower-limit alarm,” “upper and lower-limit range alarm,” or “upper and lower-limit alarm with standby sequence,” the alarm’s upper and lower limits are set independently. The “alarm value 1” setting is disabled and the “alarm value upper limit 1” and “alarm value lower limit 1” settings are used as the alarm set values.

For this reason, when “upper/lower-limit alarm” is set, the value of “alarm value upper limit 1” and not “alarm value 1” is the value read by communications. The same applies to “alarm 2 type.”

● Temperature Input Shift Value

When the 2-point shift method is used, the “temperature input shift value” is disabled and the “upper-limit temperature input shift value” and “lower-limit temperature input shift value” parameters are enabled as the temperature input shift set values. For this reason, when 2-point shift method is being used, the “upper-limit temperature input shift value” is read and not the “temperature input shift values.”

The 2-point shift method will be used in the following cases:

- The “input type” is set to infrared temperature sensor.
- The “input type” is not set to infrared temperature sensor, but the “input shift type” is set to 2-point shift.

- Alarm

Only alarms 1 and 2 are supported.

Alarm 3 cannot be used.

- Heater Burnout Detection

Reads “heater burnout detection 1.” (The “heater burnout 2 detection” value is not read.)

■ Select Communications Writing

The logic of the MB command changes as shown in the table below according to the MB command logic switching setting (advanced function level). The MB command (communications writing selection) is equivalent to the E5□J Controller’s MB command (remote/local switching).

Text data of MB command	MB command logic switching setting	
	OFF	ON
0000	Communications writing enabled (remote mode selection)	Communications writing disabled (local mode selection)
0001	Communications writing disabled (local mode selection)	Communications writing enabled (remote mode selection)

- The default value of the MB Command Logic Switching Setting is OFF (same logic as E5□J).

SECTION 5

Modbus Communications Procedure

Read this section if you are to communicate using the Modbus format.

5.1	Data Format.....	5-2
	Command Frame.....	5-2
	CRC-16 Calculation Example.....	5-3
	Response Frame	5-4
	Normal Response Frame	5-4
	Error Response Frame.....	5-4
	Error Codes	5-5
	No Response.....	5-5
5.2	Function List	5-6
5.3	Variable Area	5-7
	Addresses	5-7
	Number of Elements.....	5-8
	Set Values	5-8
5.4	Detailed Description of the Services.....	5-9
	Read Variable Area	5-9
	Write Variable Area	5-11
	Operation Commands	5-14
	Echoback Test.....	5-19

5.1 Data Format

The data format complies with the Modbus (RTU) communications protocol, so commands from the host computer and responses from the E5CN are contained in data blocks called frames.

The structure of the command and response frames is described below.

In the following explanations, hexadecimal values are expressed by adding the prefix H' before the number, e.g., H'02. Numbers and alphabetic characters without the H' prefix are ASCII characters.

■ Command Frame

When using RTU mode, start with a silent interval of at least 3.5 character times and end with a silent interval of at least 3.5 character times.

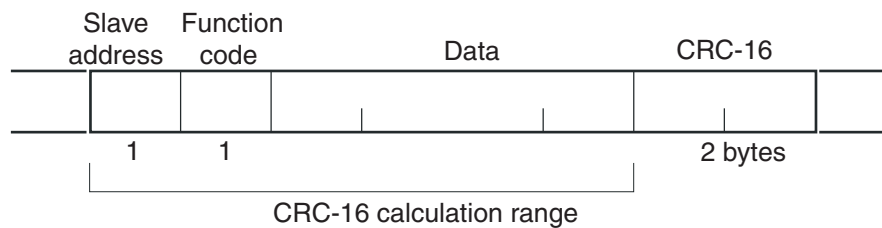

	Silent interval of 3.5 character times min.
Slave address	Specify the unit number. The unit number can be set between H'00 to H'63 hexadecimal (0 to 99 decimal). Specify H'00 for a broadcast transmission. No responses will be returned for broadcast transmissions.
Function code	The function code is a 1-byte hexadecimal code that indicates the type of command sent from the host device.
Data	This is the text data associated with the specified function code. Specify the required data, such as the variable address or setting data. (Set in hexadecimal.)
CRC-16	Cyclical Redundancy Check This check code is calculated with the data from the slave address to the end of the data. The check code is 2-byte hexadecimal.
	Silent interval of 3.5 character times min.

● CRC-16 Calculation Example

Messages are processed one byte at a time in the work memory (a 16-bit register known as the CRC register).

- (1) The CRC register is initialized to H'FFFF.
- (2) An XOR operation is performed on the content of the CRC register and the first byte of the message, and the result is returned to the CRC register.
- (3) The MSB is packed with zeroes and the CRC register is shifted 1 bit to the right.
- (4) If the bit shifted from the LSB is 0, step 3 is repeated (next bit-shift processing).
If the bit shifted from the LSB is 1, an XOR is performed on the content of the CRC register and H'A001, and the result is returned to the CRC register.
- (5) Steps 3 and 4 are repeated until 8 bits are shifted.
- (6) CRC processing continues to the end of the message, as XOR operations are performed on the content of the CRC register and the next byte of the message, step 3 is repeated, and the result is returned to the CRC register.
- (7) The result of the CRC calculation (value in the CRC register) is appended to the last byte of the message.

Example of Appending the Calculation Result

When the calculated CRC value is H'1234, the CRC value is appended to the command frame as follows.

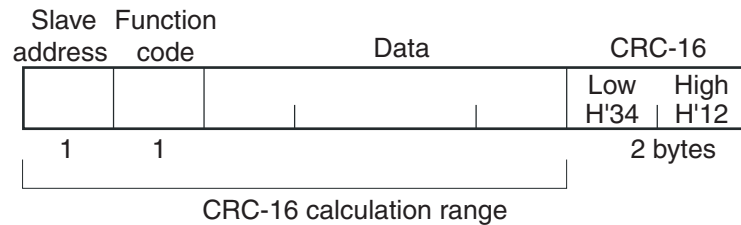

■ Response Frame

● Normal Response Frame

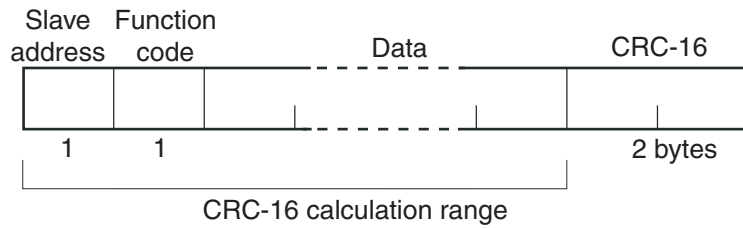

● Error Response Frame

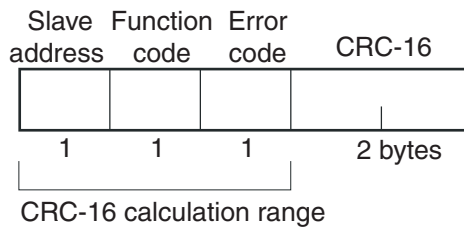

Slave address	The number specified in the command frame is entered as-is. This is the unit number of the Unit returning the response.
Function code	This is the received function code with the hexadecimal value of H'80 added to indicate that the response is an error response. Example: Received function code = H'03 Function code in response frame when an error occurred = H'83
Error code	This code indicates the kind of error that occurred.
CRC-16	Cyclical Redundancy Check This check code is calculated with the data from the slave address to the end of the data. The check code is 2-byte hexadecimal.

■ Error Codes

End code	Name	Description	Error detection priority
H'01	Function code error	An unsupported function code was received.	1
H'02	Variable address error	The specified variable area address is out-of-range.	2
H'03	Variable data error	The amount of data does not match the number of elements. The byte count is not 2 times the number of elements. The response length exceeds the size of the communications buffer. The command code or related information in the operation command is wrong or the write data is not in the setting range.	3
H'04	Operation error	The write data contents are not allowed in the present operation mode. <ul style="list-style-type: none"> ◆ The “communications writing” parameter is set to “OFF” (disabled). ◆ Write operation was performed to write the parameters from setup area 0 to setup area 1. ◆ Write operation was performed on a protected parameter other than in the protect level. ◆ AT execution in progress ◆ The command cannot be processed. 	4

● No Response

In the following cases, the received command will not be processed and a response will not be returned.

Consequently, a timeout error will occur at the host device.

- The slave address in the received command does not match the communications unit number.
- A parity error, framing error, or overrun error occurred due to a problem such as a transfer error.
- A CRC-16 code error occurred in the received command frame.
- There was a time interval of more than 3.5 character times between data packets that make up the command frame.

Furthermore, the specified function's processing will be performed but no response will be returned for broadcast functions (slave address = H'00).

5.2 Function List

The following table lists the function codes.

Function Code List

Function code	Name	Process
03 (H'03)	Read variable (multiple)	This function reads from variable areas. It is possible to read two or more consecutive variables.
16 (H'10)	Write variable (multiple)	This function writes to variable areas. It is possible to write two or more consecutive variables. It is also possible to broadcast this function (broadcast transmission).
06 (H'06)	Write variable (operation command)	This function writes an operation command. It is also possible to broadcast this function (broadcast transmission).
08 (H'08)	Echoback Test	This function performs an echoback test.

5.3 Variable Area

The variable area is the region of memory used to exchange data with the E5CN through communications.

Operations such as reading the process value and reading/writing parameters are performed on the variable area.

On the other hand, operation commands do not use the variable area.

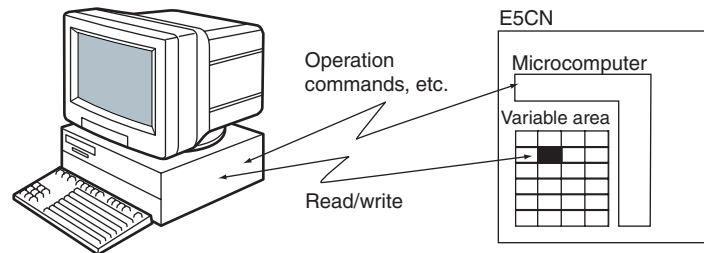

When accessing the variable area, the position of a variable in the variable area is specified with a word identifier, area number, and address in the area.

● Addresses

An address is appended to each of the variable types. Express addresses in 2-byte hexadecimal and append them for the specified access size. Each address is composed of a word identifier, area number, and address in the area.

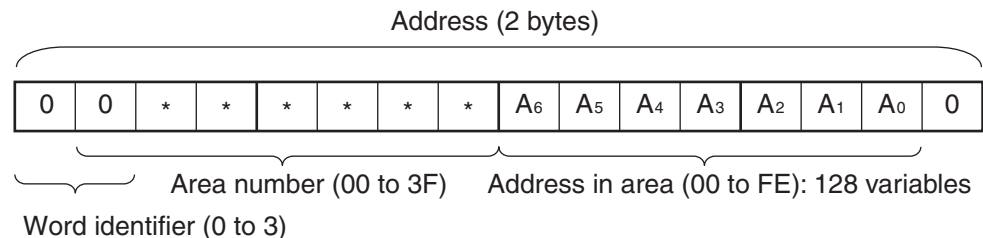

◆ Modbus Addresses Corresponding to CompoWay/F Setup Areas 0 and 1

Setup area 0 and setup area 1 do not correspond directly to Modbus addresses, but the following areas have a rough correspondence with one exception.

Setup area	Modbus addresses	
	Area number	Address range
Setup area 0	00 to 0B	0000 to 0BFE
Setup area 1	0C to 3F	0C00 to 3FFE

* Partial Exception to Modbus Address Correspondence

The Hysteresis (heating), Hysteresis (cooling), Control period (heating), and Control period (cooling) parameters are assigned to consecutive addresses, but the control period parameters are setup area 1 param-

eters. For this reason, an operation error will occur when writing the control period (heating or cooling) from the setup area 0 side, e.g., from the operation level.

● Number of Elements

The number of elements is expressed in 2-byte hexadecimal. The setting range for the number of elements varies according to the command.

For example, when the number of elements is "0010," this specifies eight items of data (H'10) from the address.

In Modbus protocol, one element occupies 2 bytes of data, but the setting data occupies 4 bytes of data.

● Set Values

The values read from the variable area or written to the variable area are expressed in hexadecimal, ignoring the decimal point position. (Negative values are expressed in 2's complement format.)

Example: D'105.0 → H'0000041A

The variables are 8-digit hexadecimal values. Negative values are expressed in 2's complement format. The values are hexadecimal values with no decimal point indication.

For example, when the E5CN's process value is 105.0, the read value is H'0000041A (105.0 → 1050 → H'0000041A).

5.4 Detailed Description of the Services

■ Read Variable Area

To read from the variable area, set the required data in the command frame, as shown in the following diagram.

Command Frame

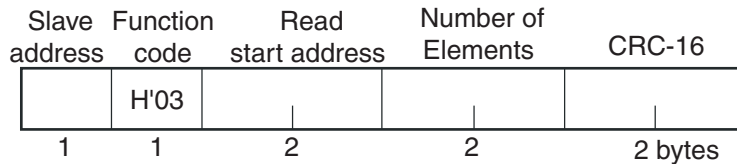

Name	Description
Slave address	Specify the E5CN's unit number. The unit number can be set between H'01 and H'63 hexadecimal (1 to 99 decimal).
Function code	The Read Variable Area function's function code is H'03.
Read start address	Specify the address containing the data to be read. See <i>SECTION 6 Communications Data for Modbus</i> for details on addresses.
Number of elements	Specify 2 times the number of setting data items as the number of elements to be read. The setting range for the number of elements is H'0002 to H'0010 (2 to 16). Example: When reading 2 items of setting data, set the number of elements to H'0004.
CRC-16	This check code is calculated with the data from the slave address to the end of the data. For details on the CRC-16 calculation, see <i>CRC-16 Calculation Example</i> in <i>5.1 Data Format</i> on page 5-3.

Response Frame

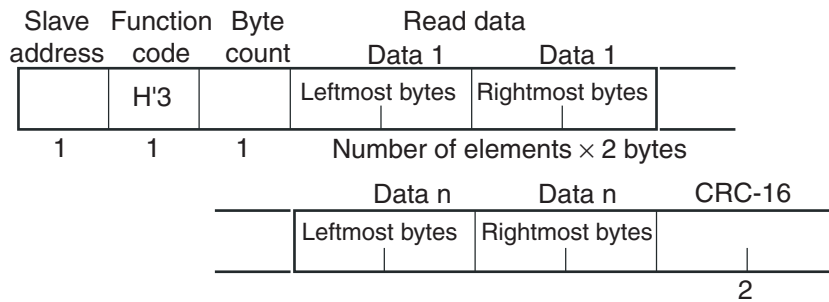

Name	Description
Slave address	The value from the command frame is entered as-is.
Function code	This is the received function code. When the function ended normally, the function code is left as-is. When an error occurred, the hexadecimal value of H'80 is added to the function code to indicate that the response is an error response. Example: Received function code = H'03 Function code in response frame when an error occurred = H'83
Byte count	Contains the number of bytes of read data.
Number of elements	Contains the number of setting data items that were read.
CRC-16	This check code is calculated with the data from the slave address to the end of the data. For details on the CRC-16 calculation, see <i>CRC-16 Calculation Example</i> in 5.1 Data Format on page 5-3.

Response Code

Function code	Error code	Error name	Cause
H'83	H'02	Variable address error	The read start variable address is incorrect. <ul style="list-style-type: none"> The variable area number is incorrect.
	H'03	Variable data error	The number of elements exceeds the allowed range.
H'03	---	Normal completion	No errors were found.

◆ Reading Undisplayed Parameters

It is possible to read the parameters that are not displayed due to display settings as well as the parameters that are never displayed in the Controller.

Example Command and Response

The following example shows the command/response when reading the process value. (In this case, the slave address is H'01.)

Process Value

- Address: H'0000; Read data: H'000003E8 (100.0 °C)

Command: 01 03 00 00 01 02 C4 0B(CRC-16)

Response: 01 03 04 00 00 03 E8 FA 8D(CRC-16)

■ Write Variable Area

To write data to the variable area, set the required data in the command frame, as shown in the following diagram.

Command Frame

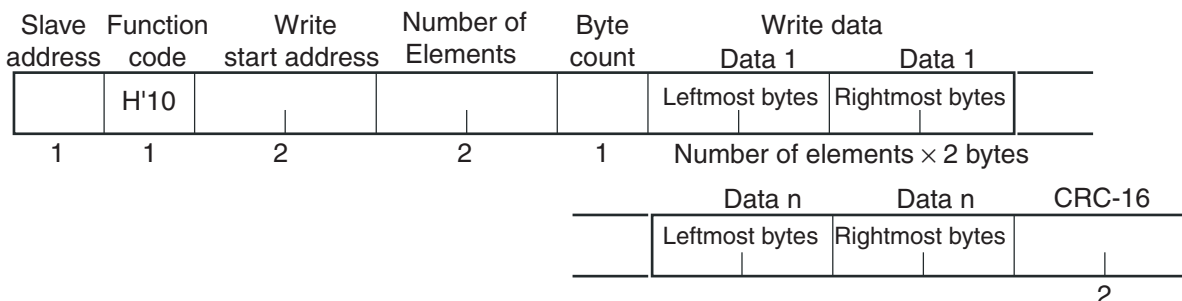

Name	Description
Slave address	Specify the E5CN's unit number. The unit number can be set between H'01 and H'63 hexadecimal (1 to 99 decimal).
Function code	The Write Variable Area function's function code is H'10.
Write start address	Specify the starting address where the setting data will be written. See <i>SECTION 6 Communications Data for Modbus</i> for details on addresses.
Number of elements	Specify 2 times the number of setting data items as the number of elements to be written. The setting range for the number of elements is H'0002 to H'0010 (2 to 16). Example: When writing 2 items of setting data, set the number of elements to H'0004.
Byte count	Specify the number of bytes of write data.
CRC-16	This check code is calculated with the data from the slave address to the end of the data. For details on the CRC-16 calculation, see <i>CRC-16 Calculation Example</i> in 5.1 Data Format on page 5-3.

Response Frame

Slave address	Function code	Write start address	Number of Elements	CRC-16
	H'10			
1	1	2	2	2 bytes

Name	Description
Slave address	The value from the command frame is entered as-is.
Function code	This is the received function code. When the function ended normally, the function code is left as-is. When an error occurred, the hexadecimal value of H'80 is added to the function code to indicate that the response is an error response. Example: Received function code = H'10 Function code in response frame when an error occurred = H'90
Write start address	This is the received write start address.
Number of elements	This is the received number of elements.
CRC-16	This check code is calculated with the data from the slave address to the end of the data. For details on the CRC-16 calculation, see <i>CRC-16 Calculation Example</i> in 5.1 Data Format on page 5-3.

Response Code

Function code	Error code	Error name	Cause
H'90	H'02	Variable address error	The write start variable address is incorrect. • The variable area number is incorrect.
	H'03	Variable data error	<ul style="list-style-type: none"> ◆ The amount of data does not match the number of elements. ◆ The byte count is not 2 times the number of elements. ◆ The write data is out of the setting range.
	H'04	Operation error	<p>The Controller cannot write the data in its present operating status. The write data contents are not allowed in the present operation mode.</p> <ul style="list-style-type: none"> ◆ The “communications writing” parameter is set to “OFF” (disabled). ◆ Write operation was performed on the parameters from setup area 0 to setup area 1. ◆ Write operation was performed on a protected parameter other than in the protect level. ◆ AT execution in progress
H'S10	---	Normal completion	No errors were found.

◆ Writing Undisplayed Parameters

It is possible to write the parameters that are not displayed due to display settings as well as the parameters that are never displayed in the Controller.

Example Command and Response

The following example shows the command/response when writing the “upper-limit alarm 1” and “lower-limit alarm 1” parameters.
(In this case, the slave address is H'01.)

Upper-limit alarm 1

- Address: H'010A Write data: H'000003E8 (1,000)

Lower-limit alarm 1

- Address: H'010C Write data: H'FFFFFFC18 (-1,000)

Command: 01 10 01 0A 00 04 08 00 00 03 E8 FF FF FC 18 8D E9(CRC-16)
Response: 01 10 01 0A 00 04 E0 34(CRC-16)

■ Operation Commands

This function performs commands such as communications writing, run/stop, multi-SP, AT (auto-tuning) execute/cancel, write mode, save RAM data, software reset, move to setup area 1, move to protect level, auto/manual mode, initialize settings, clear alarm latch, and program start.

Command Frame

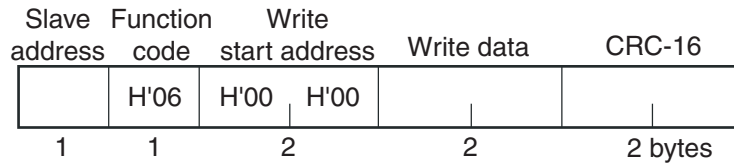

Response Frame

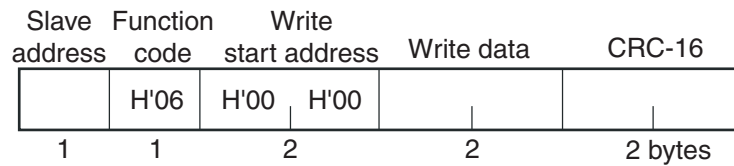

(1) Command Code and Related Information

Command code	Command content	Related information
00	Communications writing	00: OFF (disabled) 01: ON (enabled)
01	RUN/STOP	00: Run 01: Stop
02	Multi-SP	00: Set point 0 01: Set point 1 02: Set point 2 03: Set point 3
03	AT execute/cancel	00: Cancel 01: AT execute
04	Write mode	00: Backup 01: RAM
05	Save RAM data	00
06	Software reset	00
07	Move to setup area 1	00
08	Move to protect level	00
09	Auto/manual switch	00: Automatic mode 01: Manual mode
0B	Parameter initialization	00: Initialize to defaults 01: Initial settings service values
11	Program start	00: Reset 01: Start

* No response will be returned when a software reset is carried out.

(2) Response Code

Normal Completion

Function code	Error code	Name	Description
H'06	---	Normal completion	No errors were found.

Error Occurred

Function code	Error code	Name	Description
H'86	H'02	Variable address error	The write variable address was not "0000."
	H'03	Variable data error	The write data is incorrect. <ul style="list-style-type: none"> Command code or related information are incorrect.
	H'04	Operation error	The Controller cannot write the data in its present operating status. <ul style="list-style-type: none"> The "communications writing" parameter is set to "OFF" (disabled). The command is received regardless of the "communications writing" parameter setting (ON/OFF). Processing could not be performed. For details, see (4) <i>Operation Commands and Precautions</i> below.

(3) Example Command and Response

The following example shows the command/response for a Stop command. (In this case, the slave address is H'01.)

Stop command (command code: 01; related information: 01)

•Address: H'0000 (fixed)

Write data: H'0101 (Run/Stop, Stop command)

Command: 01 06 00 00 01 01 49 9A(CRC-16)

Response: 01 06 00 00 01 01 49 9A(CRC-16)

(4) Operation Commands and Precautions

● Communications Writing

Set the “communications writing” parameter to “ON” (enabled) or “OFF” (disabled) with the related information setting.

The setting can be accepted in both setup area 0 and setup area 1.

● RUN/STOP

Set control to “run” or “stop” with the related information setting. The setting can be accepted in both setup area 0 and setup area 1.

● Multi-SP

Set four set points beforehand in the adjustment level so that you can switch to a desired set point. The setting can be accepted in both setup area 0 and setup area 1.

● AT Execute/Cancel

Set AT (auto-tuning) to “execute” or “cancel” with the related information setting. This command can be accepted in setup area 0 only. An “operation error” will be generated in the following instances:

- When the “run/stop” parameter is set to “stop”
- When the command is executed in “setup area 1”
- When ON/OFF control is being used

● Write Mode

Set either “backup mode” or “RAM write mode” with the related information setting. The setting can be accepted in both setup area 0 and setup area 1.

Write mode	Description
Backup mode	The data is written to EEPROM when the parameters in the operation/adjustment levels (excluding read-only parameters) are written by communications.
RAM write mode	The data is not written to EEPROM when the parameters in the operation/adjustment levels (excluding read-only parameters) are written by communications. Parameters can be changed by operating the keys on the front panel of the controller.

- When the mode is switched from RAM write mode to backup mode, the parameters in the operation/adjustment levels (excluding read-only parameters) are written to EEPROM.
- The RAM write mode is enabled only when the “communications writing” parameter is set to “ON” (enabled).

Consequently, when the “communications writing” parameter setting is changed to “OFF” (disabled), the parameters in the operation/adjustment levels (excluding read-only parameters) are written to EEPROM even if the RAM write mode is set to “disabled.”

- RAM Data

This command writes the parameters in the operation/adjustment levels (excluding read-only parameters) to EEPROM. The setting can be accepted in both setup area 0 and setup area 1.

- Software Reset

Restarts processing from the point when power is turned ON. The setting can be accepted in both setup area 0 and setup area 1. No response will be returned for this operation.

- Move to Setup Area 1

This command moves to “setup area 1” and can be accepted at both setup areas 0 and 1. If the “initial setup/communications protection” is set to “2,” an “operation error” will be generated, and the move to setup area 1 will be prohibited.

When this move is carried out from setup area 0, the display indicates the “input type” in the “initial setting level.” When this operation command is executed in setup area 1, the display will not change.

- ◆ Moving to Setup Area 1 in Manual Mode

When this operation command is issued in manual mode, an “operation error” will be generated, and the move to setup area 1 will be prohibited.

- Move Protect Level

This command moves to the “protect level” and can be accepted only in setup area 0. When this command is issued in setup area 1, an “operation error” will be generated, and the move to the protect level will be prohibited.

- ◆ Moving the Protect Level in Manual Mode

When this operation command is issued in manual mode, an “operation error” will be generated, and the move to the protect level will be prohibited.

● **Auto/Manual Switch**

This operation command switches the mode to manual mode or automatic mode, based on the related information setting. This command can be accepted in setup area 0 only. An “operation error” will be generated in the following instances:

- When the command is executed in “Setup Area 1”
- When auto/manual switching is disabled (not displayed)

When the Controller is switched to manual mode, the “manual manipulated variable” will be displayed. When the Controller is switched from manual mode to automatic mode, the operation level’s first parameter will be displayed. When the Controller is switched to manual mode while already in manual mode, the command will be completed normally and the display will not change (the contents will not be refreshed).

● **Writing Auto/Manual Status in EEPROM**

The write mode determines whether the auto/manual status is written to EEPROM.

Write mode	Description
Backup mode	When the auto/manual mode is switched by communications, the auto/manual status is written to EEPROM.
RAM write mode	When the auto/manual mode is switched by communications, the auto/manual status is not written to EEPROM. The status can be written with the Controller key operations.

* When the auto/manual mode is switched with an operation command through communications and the Controller is in RAM write mode, the auto/manual status is not stored in EEPROM. Consequently, if the Controller is restarted by performing a software reset or turning the power OFF and ON again, the auto/manual mode is set to the last saved status.

◆ **Switching to Manual Mode during Auto-tuning**

If the mode is switched during auto-tuning (AT), the AT will be cancelled and the Controller will be switched to manual mode.

● **Parameter Initialization**

The present settings are returned to the default values and written to EEPROM. This command can be accepted in setup area 1 only. When this command is issued in setup area 0, an “operation error” will be generated.

The set values that are set during initialization depend on the command's related information setting, as shown in the following table.

Related information	Explanation (initialization values)
00	Default set values (See <i>SECTION 3 Communications Data for CompoWay/F and SYSWAY</i> for details.) (These settings are the same as the ones used when "FACT" is selected for the setting data's set value initialization.)
01	Initial settings service values (These settings are the same as the ones used when "USER" is selected for the setting data's set value initialization.) If the initial values have not been set yet with the initial values setting service, the default initial values will be set.

● Program Start

The simple program function can be reset/started with the related information setting. The setting can be accepted in both setup area 0 and setup area 1. An operation error will be generated if program start has been set in the event input.

■ Echoback Test

Command Frame

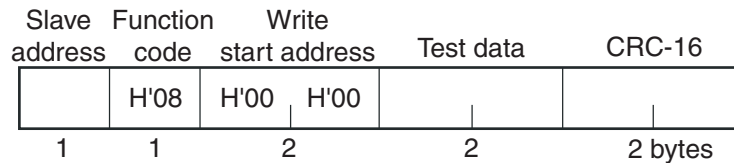

Response Frame

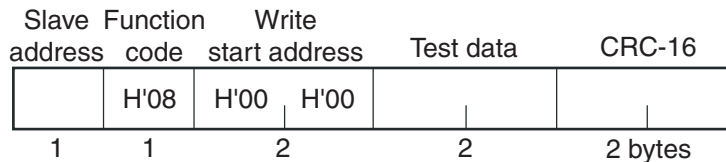

* When the command is executed normally, the response returns the same data sent in the command.

(1) Test Data

Enter any 2-byte hexadecimal data.

(2) Response Code

Function code	Error code	Name	Description
H'88	H'03	Variable data error	The data following the function code was not the fixed data (H'00, H'00).
H'08	---	Normal completion	No errors were found.

(3) Example Command and Response

The following example shows the command/response for an Echoback Test command.

(In this case, the test data is H'1234.)

(In this case, the slave address is H'01.)

Command:	01	08	00 00	12 34	ED 7C(CRC-16)
Response:	01	08	00 00	12 34	ED 7C(CRC-16)

SECTION 6

Communications Data for Modbus

This section lists the details of the communications data in the Modbus communications protocol.

6.1	Variable Area (Setting Range) List	6-2
6.2	Status.....	6-15

6.1 Variable Area (Setting Range) List

The following table lists the variable areas. Items expressed in hexadecimal in the “Set (monitor) value” column are the setting range in the Modbus specifications. Values in parentheses “()” are the actual setting range.

When there is a section reference for a setting item, refer to that reference for details.

Address	Parameter name	Setting (monitor) value	Level
0000	PV	Temperature: Use the specified range for each sensor. Analog: Scaling lower limit – 5% FS to Scaling upper limit + 5% FS	Operating
0002	Status (See note 1.)	See the <i>Communications Specifications</i> for details.	
0004	Internal set point (See note 1.)	SP lower limit to SP upper limit	
0006	Heater current 1 value monitor	H'00000000 to H'00000226 (0.0 to 55.0)	
0008	MV monitor (heating)	Standard: H'FFFFFFCE to H'0000041A (–5.0 to 105.0) Heating and cooling: H'00000000 to H'0000041A (0.0 to 105.0)	
000A	MV monitor (cooling)	H'00000000 to H'0000041A (0.0 to 105.0)	
0106	Set point	SP lower limit to SP upper limit	
0108	Alarm value 1	H'FFFFFF831 to H'0000270F (–1999 to 9999)	
010A	Upper-limit alarm 1	H'FFFFFF831 to H'0000270F (–1999 to 9999)	
010C	Lower-limit alarm 1	H'FFFFFF831 to H'0000270F (–1999 to 9999)	
010E	Alarm value 2	H'FFFFFF831 to H'0000270F (–1999 to 9999)	
0110	Upper-limit alarm 2	H'FFFFFF831 to H'0000270F (–1999 to 9999)	
0112	Lower-limit alarm 2	H'FFFFFF831 to H'0000270F (–1999 to 9999)	
0404	PV	Temperature: Use the specified range for each sensor. Analog: Scaling lower limit – 5% FS to Scaling upper limit + 5% FS	
0406	Internal set point (See note 1.)	SP lower limit to SP upper limit	
040C	Status (See note 1.)	See the <i>Communications Specifications</i> for details.	

Address	Parameter name	Setting (monitor) value	Level
0500	Operation/adjustment protect	H'00000000 (0): No restrictions in operation and adjustment levels H'00000001 (1): Move to adjustment level is prohibited. H'00000002 (2): Display and change of only "PV" and "PV/SP" parameters is allowed. H'00000003 (3): Display of only "PV" and "PV/SP" parameters is allowed.	Protect
0502	Initial setting/communications protect	H'00000000 (0): Move to initial setting/communications setting level is allowed. (Move to advanced function setting level is displayed.) H'00000001 (1): Move to initial setting/communications setting level is allowed. (Move to advanced function setting level is not displayed.) H'00000002 (2): Move to initial setting/communications setting level is prohibited.	
0504	Setup change protection	H'00000000 (0): OFF (Changing of setup on controller display is allowed.) H'00000001 (1): ON (Changing of setup on controller display is prohibited.)	
0508	Move to protect level	H'FFFFFF831 to H'0000270F (–1999 to 9999)	
050A	Password to move to protect level	H'FFFFFF831 to H'0000270F (–1999 to 9999) (Can only be set. The monitor value is always H'00000000.)	
050C	Parameter mask enable	H'00000000 (0): OFF H'00000001 (1): ON	

Address	Parameter name	Setting (monitor) value	Level
0600	Manual manipulated variable	Standard: H'FFFFFFCE to H'0000041A (–5.0 to 105.0) Heating and cooling: H'FFFFFFBE6 to H'0000041A (–105.0 to 105.0)	Operating
0602	Set point	SP lower limit to SP upper limit	
0608	Heater current 1 value monitor	H'00000000 to H'00000226 (0.0 to 55.0)	
060A	MV monitor (heating)	Standard: H'FFFFFFCE to H'0000041A (–5.0 to 105.0) Heating and cooling: H'00000000 to H'0000041A (0.0 to 105.0)	
060C	MV monitor (cooling)	H'00000000 to H'0000041A (0.0 to 105.0)	
0700	Cooling coefficient	H'00000001 to H'0000270F (0.01 to 99.99)	Adjustment
0708	Dead band	H'FFFFFF831 to H'0000270F (–199.9 to 999.9 for TC/Pt multi-input models) (–19.99 to 99.99 for Analog input models)	
070A	Manual reset value	H'00000000 to H'000003E8 (0.0 to 100.0)	
070C	Hysteresis (heating)	H'00000001 to H'0000270F (0.1 to 999.9 for TC/Pt multi-input models) (0.01 to 99.99 for Analog input models)	
070E	Hysteresis (cooling)	H'00000001 to H'0000270F (0.1 to 999.9 for TC/Pt multi-input models) (0.01 to 99.99 for Analog input models)	
0710	Control period (heat)	H'00000000 (0): 0.5 H'00000001 to H'00000063 (1 to 99)	Initial setting
0712	Control period (cool)	H'00000000 (0): 0.5 H'00000001 to H'00000063 (1 to 99)	
0718	SP ramp time unit	H'00000000 (0): EU/second H'00000001 (1): EU/minute	Advanced function setting
071A	SP ramp set value	H'00000000 (0): OFF H'00000001 to H'0000270F (1 to 9999)	Adjustment
071E	MV at stop	Standard: H'FFFFFFCE to H'0000041A (–5.0 to 105.0) Heating and cooling: H'FFFFFFBE6 to H'0000041A (–105.0 to 105.0)	
0722	MV at PV error	Standard: H'FFFFFFCE to H'0000041A (–5.0 to 105.0) Heating and cooling: H'FFFFFFBE6 to H'0000041A (–105.0 to 105.0)	
072C	Lower-limit temperature input shift value	H'FFFFFF831 to H'0000270F (–199.9 to 999.9)	
0730	Upper-limit temperature input shift value	H'FFFFFF831 to H'0000270F (–199.9 to 999.9)	
0734	Heater current 1 value monitor	H'00000000 to H'00000226 (0.0 to 55.0)	Operating
0736	Heater burnout detection 1	H'00000000 to H'000001F4 (0.0 to 50.0)	Adjustment
0738	Leakage current value 1 monitor	H'00000000 to H'00000226 (0.0 to 55.0)	Operating

Address	Parameter name	Setting (monitor) value	Level
073A	HS alarm 1	H'00000000 to H'000001F4 (0.0 to 50.0)	Adjustment
0746	Temperature input shift value	H'FFFFFF831 to H'0000270F (-199.9 to 999.9)	
0748	Heater current value 2 monitor	H'00000000 to H'00000226 (0.0 to 55.0)	Operating
074A	Heater burnout 2 detection	H'00000000 to H'000001F4 (0.0 to 50.0)	Adjustment
074C	Leakage current value 2 monitor	H'00000000 to H'00000226 (0.0 to 55.0)	Operating
074E	HS alarm 2	H'00000000 to H'000001F4 (0.0 to 50.0)	Adjustment
0750	Soak time remain monitor	H'00000000 to H'0000270F (0 to 9999)	Operating
0752	Soak time	H'00000001 to H'0000270F (1 to 9999)	Adjustment
0754	Wait band	H'00000000 (0): OFF H'00000001 to H'0000270F (0.1 to 999.9 for TC/Pt multi-input models) (0.01 to 99.99 for Analog input models)	

Address	Parameter name	Setting (monitor) value	Level
0800	Input digital filter	H'00000000 to H'0000270F (0.0 to 999.9)	Advanced function setting
0900	Set point 0	SP lower limit to SP upper limit	Adjustment
0904	Alarm value 1	H'FFFFFF831 to H'0000270F (-1999 to 9999)	Operating
0906	Upper-limit alarm 1	H'FFFFFF831 to H'0000270F (-1999 to 9999)	
0908	Lower-limit alarm 1	H'FFFFFF831 to H'0000270F (-1999 to 9999)	
090A	Alarm value 2	H'FFFFFF831 to H'0000270F (-1999 to 9999)	
090C	Upper-limit alarm 2	H'FFFFFF831 to H'0000270F (-1999 to 9999)	
090E	Lower-limit alarm 2	H'FFFFFF831 to H'0000270F (-1999 to 9999)	
0910	Alarm value 3 (See note 2.)	H'FFFFFF831 to H'0000270F (-1999 to 9999)	
0912	Upper-limit alarm value 3 (See note 2.)	H'FFFFFF831 to H'0000270F (-1999 to 9999)	
0914	Lower-limit alarm value 3 (See note 2.)	H'FFFFFF831 to H'0000270F (-1999 to 9999)	
091C	Set point 1	SP lower limit to SP upper limit	
0938	Set point 2	SP lower limit to SP upper limit	
0954	Set point 3	SP lower limit to SP upper limit	
0A00	Proportional band	H'00000001 to H'0000270F (0.1 to 999.9)	
0A02	Integral time	H'00000000 to H'00000F9F (0 to 3999)	
0A04	Derivative time	H'00000000 to H'00000F9F (0 to 3999) (Range when RT is "OFF.") H'00000000 to H'0000270F (0.0 to 999.9) (Range when RT is "ON.")	
0A0A	MV upper limit	Standard: MV lower limit + 0.1 to H'0000041A (MV lower limit + 0.1 to 105.0)	
0A0C	MV lower limit	Standard: H'FFFFFFCE to MV upper limit - 0.1 (-5.0 to MV upper limit - 0.1) Heating and cooling: H'FFFFFFBE6 to H'00000000 (-105.0 to 0.0)	

Address	Parameter name	Setting (monitor) value	Level
0C00	Input type (TC/Pt multi-input models) (See note.)	H'00000000 (0): Pt (-200 to 850°C/-300 to 1500°F) H'00000001 (1): Pt (-199.9 to 500.0°C/-199.9 to 900.0°F) H'00000002 (2): Pt (0.0 to 100.0°C/0.0 to 210.0°F) H'00000003 (3): JPt (-199.9 to 500.0°C/-199.9 to 900.0°F) H'00000004 (4): JPt (0.0 to 100.0°C/0.0 to 210.0°F)	Initial setting
		H'00000005 (5): K (-200 to 1300°C/-300 to 2300°F) H'00000006 (6): K (-20.0 to 500.0°C/0.0 to 900.0°F) H'00000007 (7): J (-100 to 850°C/-100 to 1500°F) H'00000008 (8): J (-20.0 to 400.0°C/0.0 to 750.0°F) H'00000009 (9): T (-200 to 400°C/-300 to 700°F) H'0000000A (10): T (-199.9 to 400.0°C/-199.9 to 700.0°F) H'0000000B (11): E (0 to 600°C/0 to 1100°F) H'0000000C (12): L (-100 to 850°C/-100 to 1500°F) H'0000000D (13): U (-200 to 400°C/-300 to 700°F) H'0000000E (14): U (-199.9 to 400.0°C/-199.9 to 700.0°F) H'0000000F (15): N (-200 to 1300°C/-300 to 2300°F) H'00000010 (16): R (0 to 1700°C/0 to 3000°F) H'00000011 (17): S (0 to 1700°C/0 to 3000°F) H'00000012 (18): B (100 to 1800°C/300 to 3200°F) H'00000013 (19): Infrared temperature sensor (K 140°F/60°C)	
0C00	Input type (TC/Pt multi-input models) (See note.)	H'00000014 (20): Infrared temperature sensor (K 240°F/120°C) H'00000015 (21): Infrared temperature sensor (K 280°F/140°C) H'00000016 (22): Infrared temperature sensor (K 440°F/220°C) H'00000017 (23): 0 to 50 mV	Initial setting
		Input type (Analog input models, see note) H'00000000 (0): 4 to 20 mA H'00000001 (1): 0 to 20 mA H'00000002 (2): 1 to 5 V H'00000003 (3): 0 to 5 V H'00000004 (4): 0 to 10 V	
0C02	Temperature unit	H'00000000 (0): °C H'00000001 (1): °F	
0C12	Scaling lower limit	H'FFFFFF831 to scaling upper limit -1 (-1999 to scaling upper limit -1)	
0C16	Scaling upper limit	Scaling lower limit +1 to H'0000270F (Scaling lower limit +1 to 9999)	
0C18	Decimal point position (TC/Pt multi-input models)	H'00000000 to 00000001 (0 to 1)	
	Decimal point position (Analog input models)	H'00000000 to 00000003 (0 to 3)	

Note 1. The input type can be selected to match the connected sensor.

There are two input type specifications: Thermocouple/Resistance thermometer input and Analog input.

Note 2. The alarm function can also be used in Controllers without alarm output terminals. In this case, confirm alarm occurrences via the status data.

Address	Parameter name	Setting (monitor) value	Level
0D06	Linear current output	H'00000000 (0): 4 to 20 mA H'00000001 (1): 0 to 20 mA	Initial setting
0D1E	SP upper limit	The range of values (without decimal point) is as follows: Temperature: SP lower limit + 1 to Input range upper limit Analog: SP lower limit + 1 to scaling upper limit	
0D20	SP lower limit	The range of values (without decimal point) is as follows: Temperature: Input range lower limit to SP upper limit – 1 Analog: Scaling lower limit to SP upper limit – 1	
0D22	Standard or Heating and cooling	H'00000000 (0): Standard H'00000001 (1): Heating and cooling	
0D24	Direct/reverse operation	H'00000000 (0): Reverse operation H'00000001 (1): Direct operation	
0D28	PID/OnOff	H'00000000 (0): ON/OFF H'00000001 (1): 2 degrees of freedom PID control	
0D2A	ST	H'00000000 (0): OFF H'00000001 (1): ON	
0D2C	Program pattern	H'00000000 (0): OFF H'00000001 (1): STOP H'00000002 (2): CONT	
0E00	Transfer output type	H'00000000 (0): OFF H'00000001 (1): Set point H'00000002 (2): Set point during SP ramp H'00000003 (3): PV H'00000004 (4): MV monitor (heating) H'00000005 (5): MV monitor (cooling)	
0E0C	Control output 1 assignment	When control output 1 is a linear output: H'00000000 (0): Not assigned. H'00000001 (1): Control output (heating) H'00000002 (2): Control output (cooling) When control output 1 is a pulse output: H'00000000 (0): Not assigned. H'00000001 (1): Control output (heating) H'00000002 (2): Control output (cooling) H'00000003 (3): Alarm 1 H'00000004 (4): Alarm 2 H'00000005 (5): Alarm 3 H'00000006 (6): Program end output (See note 5.)	
0E0E	Control output 2 assignment	H'00000000 (0): Not assigned. H'00000001 (1): Control output (heating) H'00000002 (2): Control output (cooling) H'00000003 (3): Alarm 1 H'00000004 (4): Alarm 2 H'00000005 (5): Alarm 3 H'00000006 (6): Program end output (See note 5.)	
0E14	Event input assignment 1	H'00000000 (0): None H'00000001 (1): RUN/STOP (Cannot be set if the “Number of multi-SP uses” is set to 1 or 2.)	

Address	Parameter name	Setting (monitor) value	Level
0E14	Event input assignment 1	H'00000002 (2): Auto/Manual (Cannot be set if the "Number of multi-SP uses" is set to 1 or 2.) H'00000003 (3): Program Start (Cannot be set if the "Number of multi-SP uses" is set to 1 or 2.) (See note 6.)	Advanced function setting
0E16	Event input assignment 2	H'00000000 (0): None H'00000001 (1): RUN/STOP (Cannot be set if the "Number of multi-SP uses" is set to 2.) H'00000002 (2): Auto/Manual (Cannot be set if the "Number of multi-SP uses" is set to 2.) H'00000003 (3): Program Start (Cannot be set if the "Number of multi-SP uses" is set to 2.) (See note 6.)	
0E20	Alarm 1 assignment	H'00000000 to H'00000006 (0 to 6) (Same settings as the control output 2 assignments)	
0E22	Alarm 2 assignment	H'00000000 to H'00000006 (0 to 6) (Same settings as the control output 2 assignments)	
0E28	Transfer output upper limit	H'FFFFFF831 to H'0000270F (–1999 to 9999) (See note 4.)	Initial setting
0E2A	Transfer output lower limit	H'FFFFFF831 to H'0000270F (–1999 to 9999) (See note 4.)	

Address	Parameter name	Setting (monitor) value	Level
0F00	Alarm 1 type	H'00000000 (0): Alarm function OFF H'00000001 (1): Upper and lower-limit alarm H'00000002 (2): Upper-limit alarm H'00000003 (3): Lower-limit alarm H'00000004 (4): Upper and lower-limit range alarm H'00000005 (5): Upper and lower-limit alarm with standby sequence H'00000006 (6): Upper-limit alarm with standby sequence H'00000007 (7): Lower-limit alarm with standby sequence H'00000008 (8): Absolute-value upper-limit alarm H'00000009 (9): Absolute-value lower-limit alarm H'0000000A (10): Absolute-value upper-limit alarm with standby sequence H'0000000B (11): Absolute-value lower-limit alarm with standby sequence H'0000000C (12): LBA (Loop Burnout Alarm)	Initial setting
0F02	Alarm 1 latch	H'00000000 (0): OFF H'00000001 (1): ON	Advanced function setting
0F04	Alarm 1 hysteresis	H'00000001 to H'0000270F (0.1 to 999.9 for TC/Pt multi-input models) (0.01 to 99.99 for Analog input models)	
0F06	Alarm 2 type	H'00000000 (0): Alarm function OFF H'00000001 (1): Upper and lower-limit alarm H'00000002 (2): Upper-limit alarm H'00000003 (3): Lower-limit alarm H'00000004 (4): Upper and lower-limit range alarm H'00000005 (5): Upper and lower-limit alarm with standby sequence H'00000006 (6): Upper-limit alarm with standby sequence H'00000007 (7): Lower-limit alarm with standby sequence H'00000008 (8): Absolute-value upper-limit alarm H'00000009 (9): Absolute-value lower-limit alarm H'0000000A (10): Absolute-value upper-limit alarm with standby sequence H'0000000B (11): Absolute-value lower-limit alarm with standby sequence	Initial setting
0F08	Alarm 2 latch	H'00000000 (0): OFF H'00000001 (1): ON	Advanced function setting
0F0A	Alarm 2 hysteresis	H'00000001 to H'0000270F (0.1 to 999.9 for TC/Pt multi-input models) (0.01 to 99.99 for Analog input models)	
0F0C	Alarm 3 type (See note 2.)	Same settings as the alarm 2 type.	Initial setting

Address	Parameter name	Setting (monitor) value	Level
0F0E	Alarm 3 latch (See note 2.)	H'00000000 (0): OFF H'00000001 (1): ON	Advanced function setting
0F10	Alarm 3 hysteresis (See note 2.)	H'00000001 to H'0000270F (0.1 to 999.9 for TC/Pt multi-input models) (0.01 to 99.99 for Analog input models)	
0F18	Standby sequence reset	H'00000000 (0): Condition A H'00000001 (1): Condition B	
0F1A	Alarm 1 open in alarm	H'00000000 (0): Close in alarm H'00000001 (1): Open in alarm	
0F1C	Alarm 2 open in alarm	H'00000000 (0): Close in alarm H'00000001 (1): Open in alarm	
0F1E	Alarm 3 open in alarm (See note 2.)	H'00000000 (0): Close in alarm H'00000001 (1): Open in alarm	
0F22	Alarm 1 ON delay	H'00000000 to H'000003E7 (0 to 999)	
0F24	Alarm 2 ON delay	H'00000000 to H'000003E7 (0 to 999)	
0F26	Alarm 3 ON delay (See note 2.)	H'00000000 to H'000003E7 (0 to 999)	
0F2A	Alarm 1 OFF delay	H'00000000 to H'000003E7 (0 to 999)	
0F2C	Alarm 2 OFF delay	H'00000000 to H'000003E7 (0 to 999)	
0F2E	Alarm 3 OFF delay (See note 2.)	H'00000000 to H'000003E7 (0 to 999)	

Address	Parameter name	Setting (monitor) value	Level
1006	Automatic display return time	H'00000000 (0): OFF H'00000001 to H'00000063 (1 to 99)	Advanced function setting
1010	Additional PV display	H'00000000 (0): OFF H'00000001 (1): ON	
1016	MV display	H'00000000 (0): OFF (display of manipulated variable OFF) H'00000001 (1): ON (display of manipulated variable ON)	
1018	Protect level move time	H'00000001 to H'0000001E (1 to 30)	
101A	PV change color	H'00000000 (0): ORG H'00000001 (1): RED H'00000002 (2): GRN H'00000003 (3): R-G H'00000004 (4): G-R H'00000005 (5): R-G.R H'00000006 (6): G-O.R H'00000007 (7): O-G.R	
101C	PV stable band	H'00000001 to H'0000270F (0.1 to 999.9 for TC/Pt multi-input models) (0.01 to 99.99 for Analog input models)	
101E	Additional auto/manual display switch	H'00000000 (0): OFF H'00000001 (1): ON	
1020	Display character switch	H'00000000 (0): OFF H'00000001 (1): ON	
1100	Protocol setting (See note 3.)	H'00000000 (0): CompoWay/F (SYSWAY) H'00000001 (1): Modbus	
1102	Communications unit number (See note 3.)	H'00000000 to H'00000063 (0 to 99)	
1104	Communications baud rate (See note 3.)	H'00000000 (0): 1.2 H'00000001 (1): 2.4 H'00000002 (2): 4.8 H'00000003 (3): 9.6 H'00000004 (4): 19.2 H'00000005 (5): 38.4	
1106	Communications data length (See note 3.)	H'00000007 (7): 7 H'00000008 (8): 8	
1108	Communications ttop bits (See note 3.)	H'00000001 (1): 1 H'00000002 (2): 2	
110A	Communications parity (See note 3.)	H'00000000 (0): None H'00000001 (1): Even H'00000002 (2): Odd	
110C	Send data wait time (See note 3.)	H'00000000 to H'00000063 (0 to 99)	

Address	Parameter name	Setting (monitor) value	Level
130A	Cold junction compensation method	H'00000000 (0): OFF H'00000001 (1): ON	Advanced function setting
1314	α	H'00000000 to H'00000064 (0.00 to 1.00)	
1328	Heater burnout latch	H'00000000 (0): OFF H'00000001 (1): ON	
132A	Heater burnout hysteresis	H'00000001 to H'000001F4 (0.1 to 50.0)	
132C	HS alarm latch	H'00000000 (0): OFF H'00000001 (1): ON	
132E	HS alarm hysteresis	H'00000001 to H'000001F4 (0.1 to 50.0)	
1334	Number of multi-SP uses	H'00000000 (0): No multi-SP H'00000001 (1): 2SP H'00000002 (2): 4SP	Advanced function setting
1336	Multi-SP usage	H'00000000 (0): OFF H'00000001 (1): ON	
1338	HB ON/OFF	H'00000000 (0): OFF H'00000001 (1): ON	
133A	MB command logic switching (See note 7.)	H'00000000 (0): OFF H'00000001 (1): ON	
133C	Input error output	H'00000000 (0): OFF H'00000001 (1): ON	
133E	Input shift type	H'00000000 (0): 1-point shift H'00000001 (1): 2-point shift	
1340	Output status during error	H'00000000 (0): 0 mA H'00000001 (1): MV at PV error	
1342	ST stable range	H'00000001 to H'0000270F (0.1 to 999.9)	
1344	RT	H'00000000 (0): OFF H'00000001 (1): ON	
1346	HS alarm	H'00000000 (0): OFF H'00000001 (1): ON	
1348	LBA detection time	H'00000000 to H'0000270F (0 to 9999)	
134A	LBA level	H'00000001 to H'0000270F (0.1 to 999.9 for TC/Pt multi-input models) (0.01 to 99.99 for Analog input models)	
134C	LBA band	H'00000000 to H'0000270F (0.0 to 999.9 for TC/Pt multi-input models) (0.00 to 99.99 for Analog input models)	
134E	Soak time units	H'00000000 (0): Minutes H'00000001 (1): Hours	
1350	Alarm SP selection	H'00000000 (0): Set point during SP ramp H'00000001 (1): Set point	

Note 1. Not displayed on the Controller display.

Note 2. The parameter will not be shown on the Controller display when alarm 3 is not assigned to an output.

Note 3. After communications parameters have been changed, they are enabled by resetting the Controller.

- Note 4. The setting (monitor) range depends on the “transfer output type” setting. (See the setting data list for details.)
- Note 5. The program end output can be set when the “program pattern” is not set to 0 (OFF).
- Note 6. Program start can be set when the “program pattern” is not set to 0 (OFF).
- Note 7. The logic of the Modbus variable writing function (operation command) is not influenced.

6.2 Status

The figure below shows the structure of the status data.

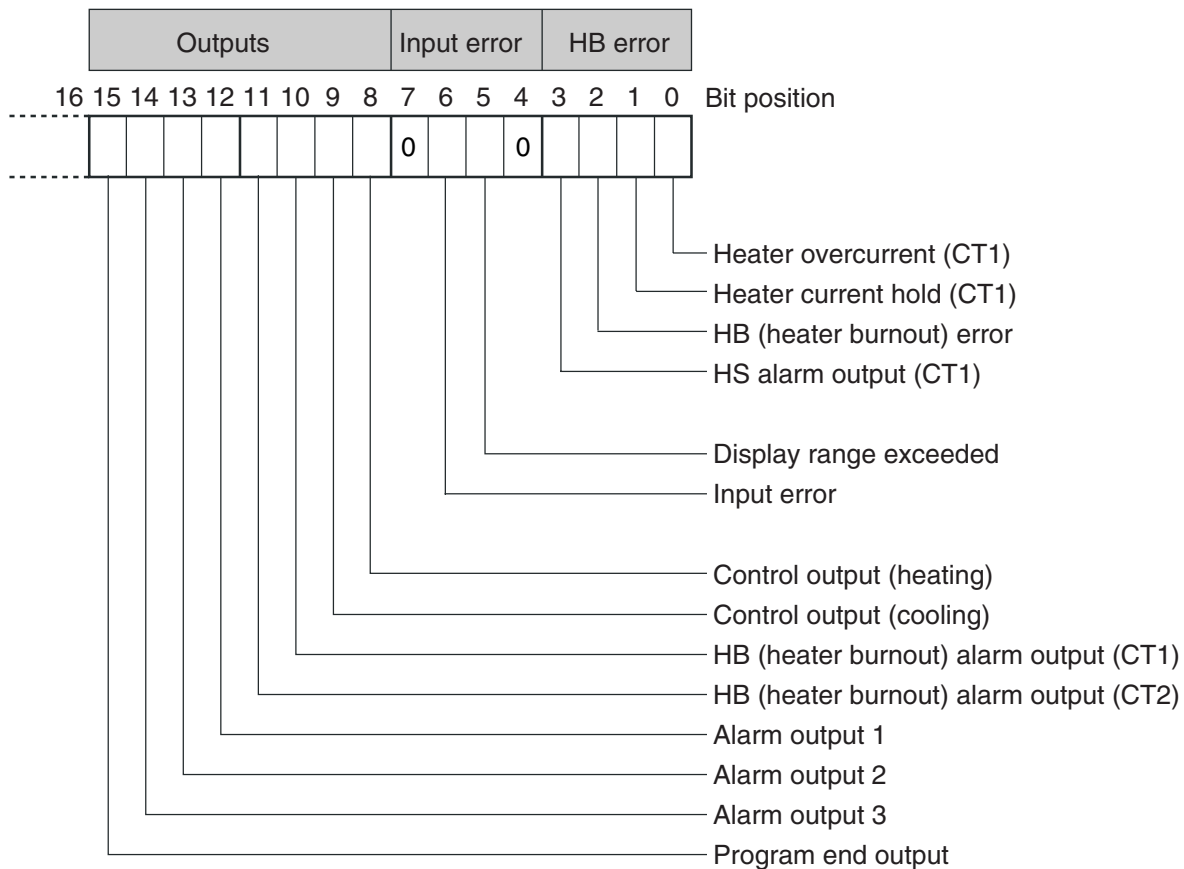

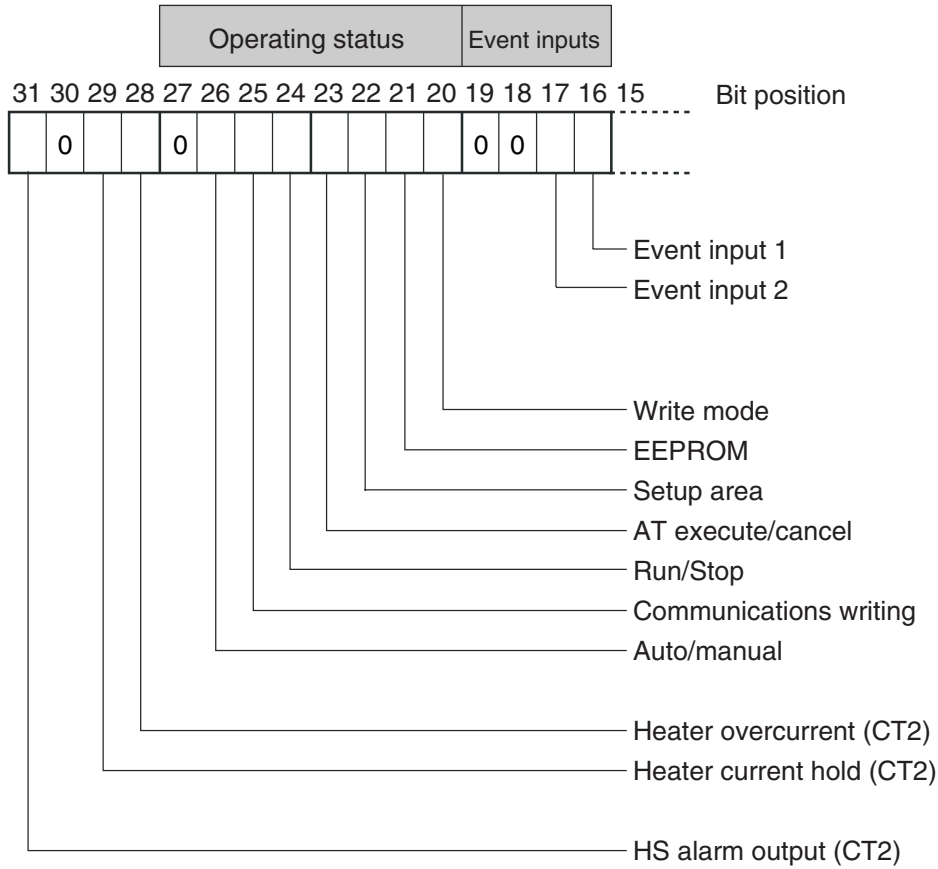

Bit position	Status	Bit Description	
		0	1
0	Heater overcurrent (CT1)	Not generated	Generated
1	Heater current hold (CT1) (See note 1.)	Update	Hold
2	HB error	Not generated	Generated
3	HS alarm output (CT1)	OFF	ON
4	Spare	OFF	---
5	Display range exceeded	Not generated	Generated
6	Input error	Not generated	Generated
7	Spare	OFF	---
8	Control output (heating)	OFF	ON
9	Control output (cooling)	OFF	ON
10	HB (Heater burnout) alarm output (CT1)	OFF	ON
11	HB (Heater burnout) alarm output (CT2)	OFF	ON
12	Alarm output 1	OFF	ON
13	Alarm output 2	OFF	ON

Bit position	Status	Bit Description	
		0	1
14	Alarm output 3	OFF	ON
15	Program end output	OFF	ON
16	Event input 1	OFF	ON
17	Event input 2	OFF	ON
18	Spare	OFF	---
19	Spare	OFF	---
20	Write mode	Backup mode	RAM write mode
21	EEPROM	RAM = EEPROM	RAM \neq EEPROM
22	Setup area	Setup area 0	Setup area 1
23	AT execute/cancel	AT canceled	AT execution in progress
24	RUN/STOP	Run	Stop
25	Communications writing	OFF (disabled)	ON (enabled)
26	Auto/manual switch	Automatic mode	Manual mode
27	Spare	OFF	---
28	Heater overcurrent (CT2)	Not generated	Generated
29	Heater current hold (CT2) (See note 1.)	Update	Hold
30	Spare	OFF	---
31	HS alarm output (CT2)	OFF	ON

Note 1. When the control output ON time is less than 190 ms, the bit is set to “1” and the heater current is held at the last current value.

Note 2. “Spare” bits are always OFF.

Note 3. When read in setup area 1, the status of the bits will be as follows:

- Overcurrent: Last value held
- HB error: Last value held
- Input error: Last value held
- HB and HS outputs: Cleared
- Program end output: Cleared
- Current hold: Last value held
- Display range exceeded: Last value held
- Heating and cooling outputs: Cleared
- Alarm outputs: Cleared

Appendix

ASCII List.....	A-2
-----------------	-----

ASCII List

	b8								
	b7	0	0	0	0	1	1	1	1
	b6	0	0	1	1	0	0	1	1
	b5	0	1	0	1	0	1	0	1

	b8	b7	b6	b5	b4	b3	b2	b1
Even parity ↑	0	0	0	0	0	0	0	0
	0	0	0	0	1	1	1	1
	0	0	1	1	0	0	0	0
	0	0	1	0	0	0	0	0
	0	1	0	0	0	0	0	0
	0	1	0	1	0	0	0	0
	0	1	1	0	0	0	0	0
	0	1	1	1	0	0	0	0
	1	0	0	0	0	0	0	0
	1	0	0	1	0	0	0	0
	1	0	1	0	0	0	0	0
	1	0	1	1	0	0	0	0
	1	1	0	0	0	0	0	0
	1	1	0	1	0	0	0	0
	1	1	1	0	0	0	0	0
	1	1	1	1	0	0	0	0

R \ C	0	1	2	3	4	5	6	7
0	NUL	DLE	SPACE	0	@	P	`	p
1	SOH	DC1	!	1	A	Q	a	q
2	STX	DC2	"	2	B	R	b	r
3	ETX	DC3	#	3	C	S	c	s
4	EOT	DC4	\$	4	D	T	d	t
5	ENQ	NAK	%	5	E	U	e	u
6	ACK	SYN	&	6	F	V	f	v
7	BEL	ETB	'	7	G	W	g	w
8	BS	CAN	(8	H	X	h	x
9	HT	EM)	9	I	Y	i	y
A	LF	SUB	*	:	J	Z	j	z
B	VT	ESC	+	;	K	[k	{
C	FF	FS	,	<	L	\	l	
D	CR	GS	-	=	M]	m	}
E	SO	RS	.	>	N	^	n	~
F	SI	US	/	?	O	_	o	DEL

Index

A

addresses
 CompoWay/F 2-7
 Modbus 5-7
area definitions 2-6
ASCII list A-2

B

BCC 1-3, 2-2, 2-3

C

command descriptions 4-5
command frame
 CompoWay/F 2-2
 Modbus 5-2
 SYSWAY 4-2
command lists
 SYSWAY 4-4
command text 2-2, 2-6
communications baud rate 1-5, 1-6
communications data
 CompoWay/F 2-4
 CompoWay/F and SYSWAY 3-1
 SYSWAY 4-3
communications data length 1-5, 1-6
communications methods 1-2
communications parameter setup 1-5
communications parameters 1-5, 1-6
communications parity 1-5, 1-7
communications protocol 1-5, 1-6
communications specifications 1-3
communications stop bits 1-5, 1-7
communications unit number 1-5, 1-6
communications writing selection 4-9
CompoWay/F 1-2, 2-1
CRC-16 5-3

D

data format
 CompoWay/F 2-2
 Modbus 5-2
 SYSWAY 4-2

E

Echoback Test
 CompoWay/F 2-7, 2-14
 Modbus 5-19
end code
 CompoWay/F 2-3, 2-4
 SYSWAY 4-5
error code 5-5
ETX 2-2

F

FCS 4-2
FINS 1-2, 2-3
function code 5-2
function list 5-6

I

interface 1-4

M

Modbus 1-2, 5-1, 6-1

N

no response
 Modbus 5-5
node number 2-2
number of elements
 CompoWay/F 2-7
 Modbus 5-8

O

Operation Command
 CompoWay/F 2-7, 2-15
 Modbus 5-14

P

PDU structure 2-6
protocol setting 1-6

R

Read Controller Attributes
 CompoWay/F 2-7, 2-12
Read Controller Status 2-7, 2-13
Read Initial Status 4-4
Read Process Value 4-4, 4-5
Read Set Values and MV Monitor
 SYSWAY 4-7
Read Variable Area
 CompoWay/F 2-7, 2-9
 Modbus 5-9
response code list
 CompoWay/F 2-20
response frame
 CompoWay/F 2-3
 Modbus 5-4
 SYSWAY 4-3
RS-485 1-4

S

send data wait time 1-5, 1-7

services details	
CompoWay/F	2-9
list (CompoWay/F)	2-7
Modbus	5-9
set values	
Modbus	5-8
SID	2-2, 2-4
slave address	5-2
status	3-15, 6-15
STX	2-2
SYSWAY	4-1

T

transmission procedure	1-3
type code (variable type)	2-6

V

variable area	
Modbus	5-7
Variable Area (setting range) list	
CompoWay/F and SYSWAY	3-2
Modbus	6-2
variable type	2-6, 2-7

W

wiring	1-4
Write Set Values	
SYSWAY	4-6
Write Variable Area	
CompoWay/F	2-10
Modbus	5-11

Revision History

A manual revision code appears as a suffix to the catalog number on the front cover of the manual.

Cat. No. H130-E1-01



The following table outlines the changes made to the manual during each revision. Page numbers refer to the previous version.

Revision code	Date	Revised content
01	June 2004	Original production