

## User Guide

Condensing Boiler with Integrated Hot Water Storage

**Promax Store**  
24

## Natural Gas

### Potterton Promax 24 Store ErP

G.C.N° 41 592 47 (90 litre)  
G.C.N° 41 592 48 (115 litre)  
G.C.N° 41 592 49 (150 litre)

#### IMPORTANT

Please read and understand all these instructions before commencing installation.  
Please leave this manual with the customer for future reference.

#### Advice to Users

Promax Store provides domestic hot water from a high performance, high efficiency version of a traditional storage cylinder. Whenever hot water is used it is replaced by fresh cold water and, provided this occurs when the programmer is in a 'DHW ON' period, the boiler will operate to raise it to the temperature you have selected. This will take from a few minutes to around 20 minutes, depending on how much hot water has been drawn from the storage cylinder. Please adjust the time and temperature settings on the programmer according to your experience of the boiler's performance and your household's need for hot water.

## Contents

Section	Page
1.0 Quick Reference Guide	3
2.0 Troubleshooting	4
3.0 Repressurising System	6
4.0 Clearances	7
5.0 Care of the Boiler	8
6.0 Legislation	9
7.0 Programmer	10
8.0 Warranty & Service	14
9.0 ErP Information	16
10.0 Notes	20
11.0 Emergency	23
12.0 Disposal	23

#### The Benchmark Scheme

Baxi Heating UK Ltd is a licensed member of the Benchmark Scheme which aims to improve the standards of installation and commissioning of domestic heating and hot water systems in the UK and to encourage regular servicing to optimise safety, efficiency and performance.

Benchmark is managed and promoted by the Heating and Hotwater Industry Council. For more information visit [www.centralheating.co.uk](http://www.centralheating.co.uk)

© Baxi Heating UK Ltd 2015 All rights reserved. No part of this publication may be reproduced or transmitted in any form or by any means, or stored in any retrieval system of any nature (including in any database), in each case whether electronic, mechanical, recording or otherwise, without the prior written permission of the copyright owner, except for permitted fair dealing under Copyrights, Designs and Patents Act 1988.

Applications for the copyright owner's permission to reproduce or make other use of any part of this publication should be made, giving details of the proposed use, to the following address:

The Company Secretary, Baxi Heating UK Ltd,  
Brooks House, Coventry Road, Warwick. CV34 4LL

Full acknowledgement of author and source must be given.

**WARNING:** Any person who does any unauthorised act in relation to a copyright work may be liable to criminal prosecution and civil claims for damages.



ISO 9001  
FM 0086

# 1.0 Quick Reference Guide

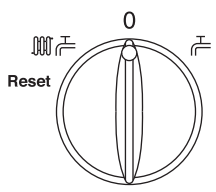
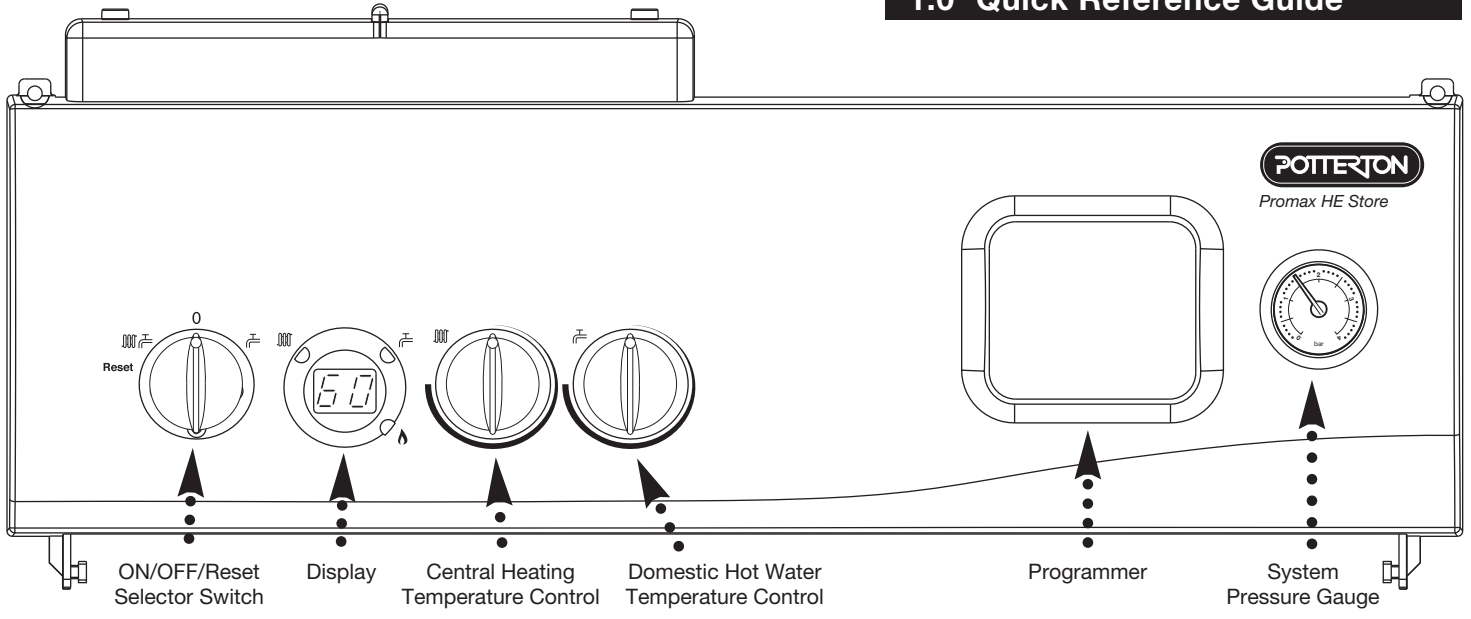

**OFF Position**  
The boiler will not operate.

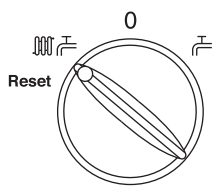



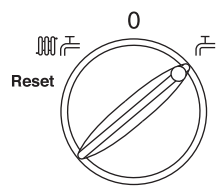

**Central Heating & Hot Water**  
Both Heating & Hot Water will operate.

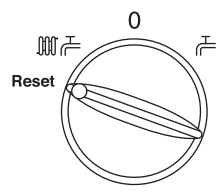

**Hot Water**  
Hot Water only will operate.



**Reset**  
Hold for approx 5 seconds and release.

-  **Central Heating Indicator** - The indicator will illuminate when the boiler is in the central heating mode.
-  **Domestic Hot Water Indicator** - The indicator will illuminate when hot water is being supplied to a tap or shower.
-  **Burner On Indicator** - The indicator will illuminate when the burner has fired and is heating your central heating or domestic hot water.
-  **Boiler Output Temperature** - In either the central heating or domestic hot water position the display will illuminate showing the current boiler temperature in degrees centigrade.

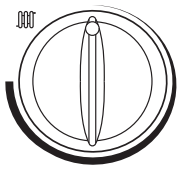

**Central Heating Temperature Control**  
Turn the knob clockwise to increase or anticlockwise to decrease the temperature. Range 25° C to 80° C.

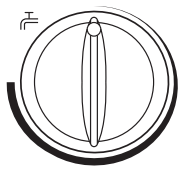

**Domestic Hot Water Temperature Control**  
Turn the knob clockwise to increase or anticlockwise to decrease the temperature. Range approximately 45° C to 65° C.

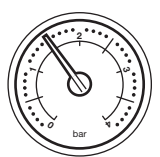

**Central Heating System Pressure** - The normal operating water pressure is between 1 and 2.0 bar. If the pressure exceeds 3 bar the safety pressure valve will operate and a fault is indicated. Contact your Installer.

# Boiler not working

## 2.0 Troubleshooting

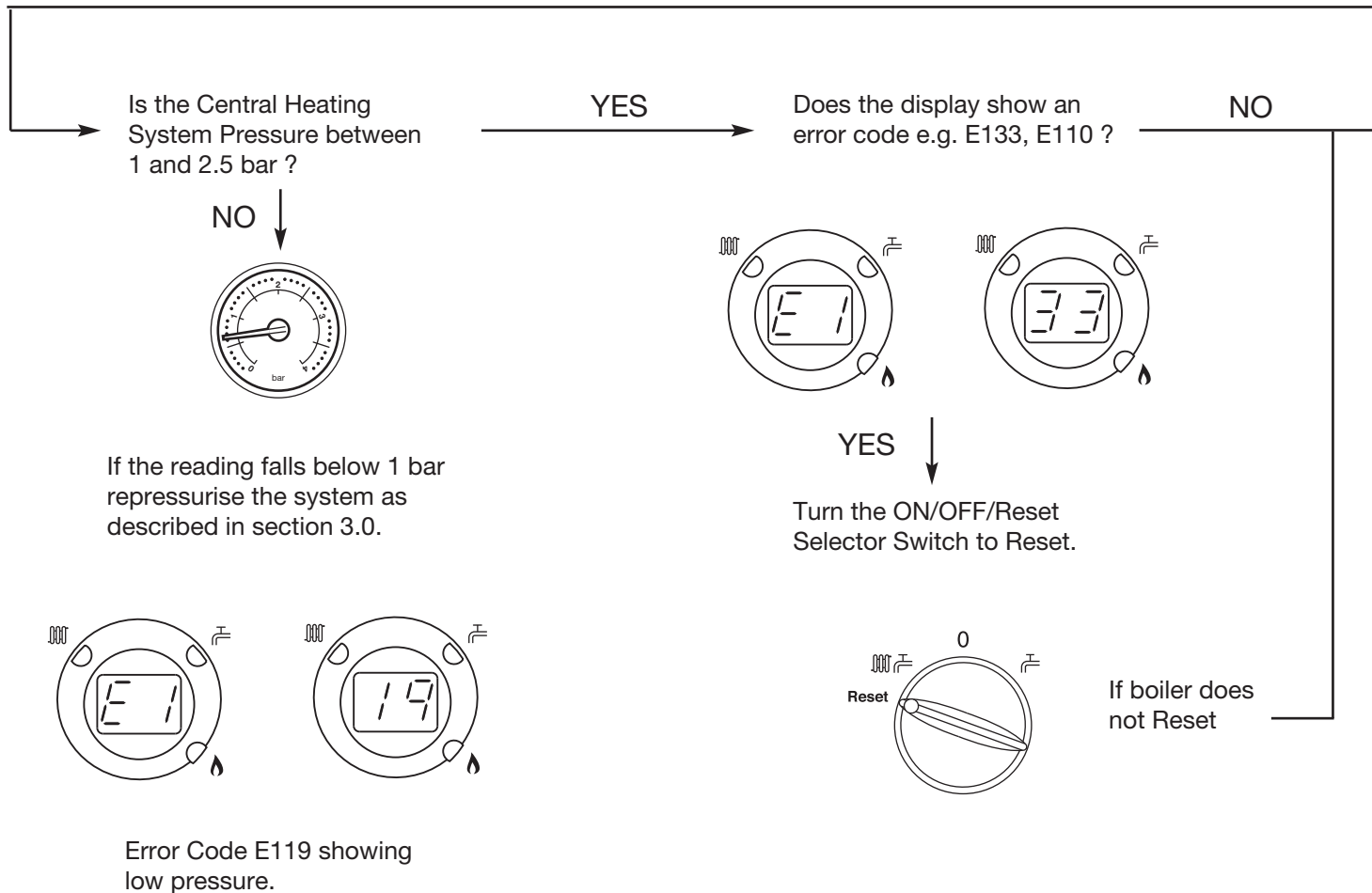
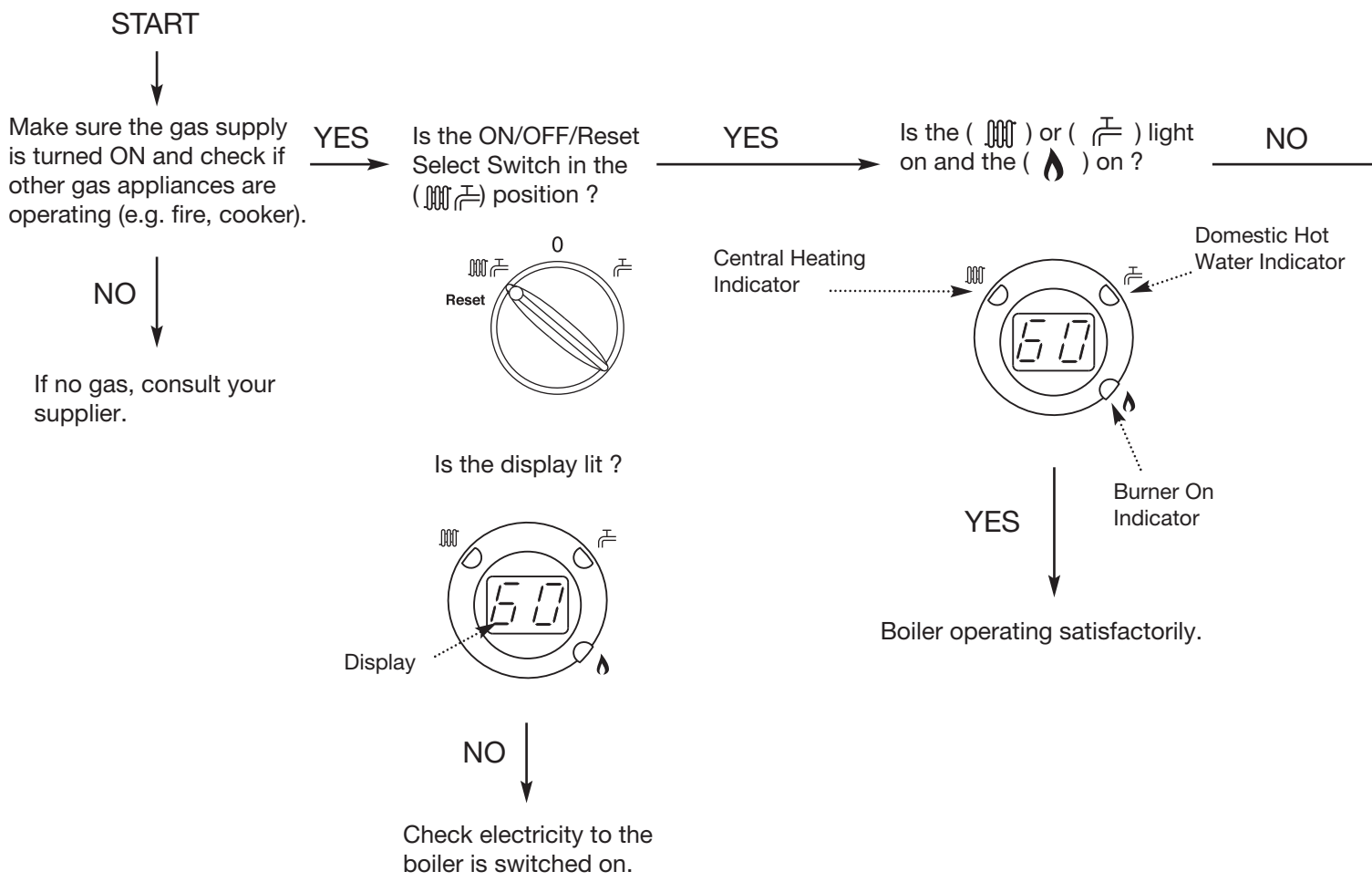

Is the Integral Programmer ON and calling for heat ?

YES

Is the Room Thermostat (if fitted) set high enough ?

YES

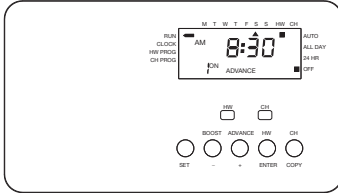

Ensure programmer is set for Central Heating ON or Hot Water ON (see section 7.4 for setting the programmer).

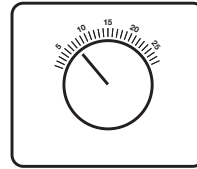

NO ↓

Turn Room Thermostat to maximum setting (typical example shown).

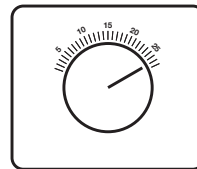

CONTACT YOUR  
INSTALLER OR  
SERVICE ENGINEER.

If you don't know what you need to do to get the boiler to light, or need help with the system and controls, contact your installer as soon as possible.

## 3.0 Repressurising System

### 3.1 Central Heating System Pressure

1. The normal operating water pressure is between 1 and 2.5 bar (Fig. 1). If the pressure exceeds 3 bar the safety pressure valve will operate and a fault is indicated. Contact your installer.

2. It may be necessary to repressurise the system occasionally (Fig. 2). A filling device (the filling loop) is fitted on the boiler itself.

3. The filling loop consists of two taps and a separate metal braided hose pipe.

4. Only when repressurising should the hose be connected between the two taps. No tools are necessary for this, but ensure that the wing nuts on the hose pipe ends are tightened onto the taps.

5. Fully open one of the taps first, and then while watching the pressure gauge, carefully open the second tap.

6. When the needle on the gauge is indicating 1 or more, turn both taps off.

7. Disconnect the hose from the taps (a small amount of water may be present) and remove it. Keep the hose in a safe place for future use.



Normal Pressure

Fig. 1



Requires  
Repressurising

Fig. 2

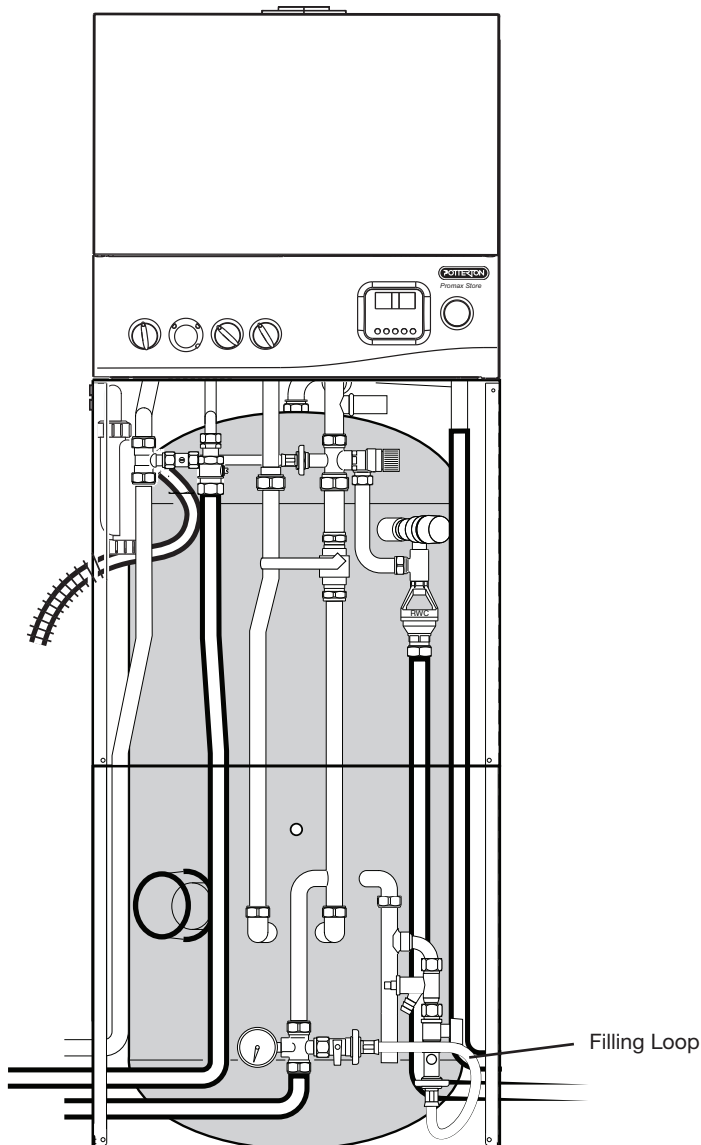

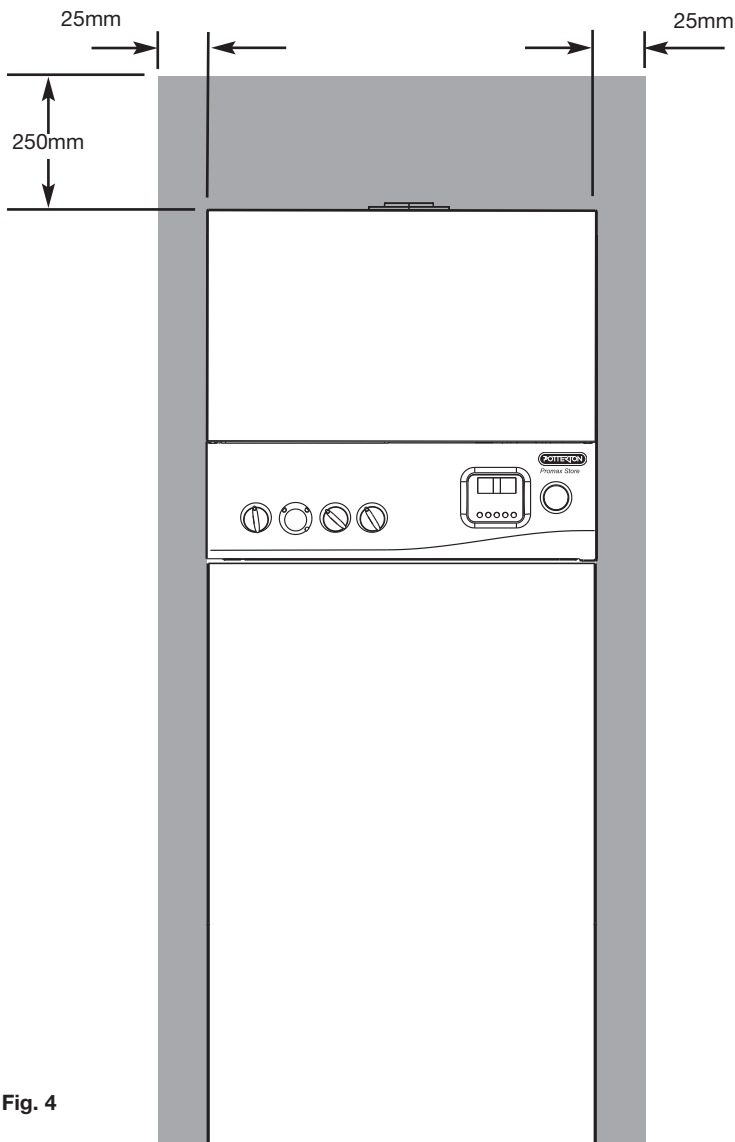

Fig. 4

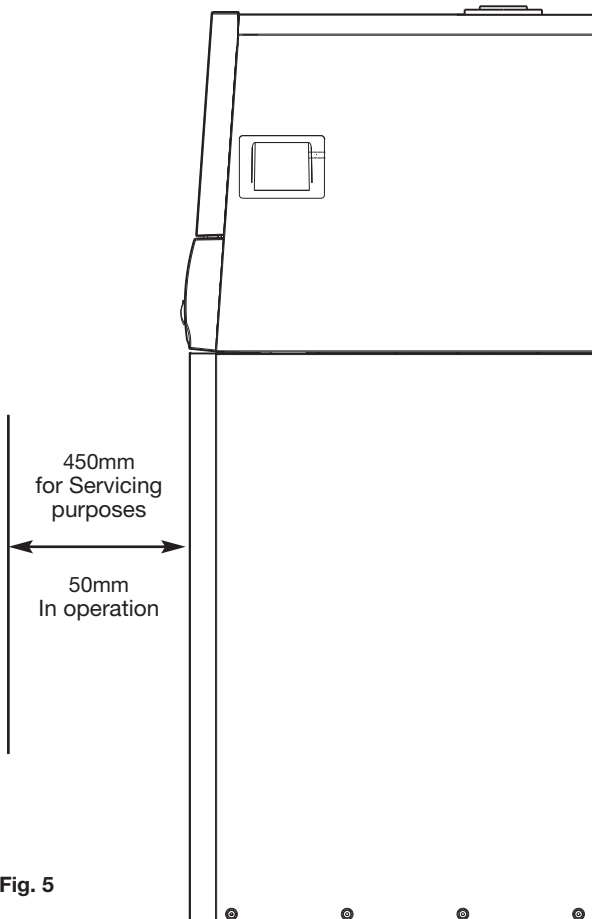

Fig. 5

## 4.0 Clearances

### 4.1 For your Safety

This appliance must have been installed in accordance with the manufacturer's instructions and the regulations in force.

Any modification that may interfere with the normal operation of the appliance without express written permission from the manufacturer or his agent could invalidate the appliance warranty. In GB this could also infringe the Gas Safety (Installation and Use) Regulations.

**GB** - Heating Industry definition meaning England, Scotland, Wales, Northern Ireland, Isle of Man and the Channel Isles

Your boiler must not be operated without the casing correctly fitted and forming an adequate seal.

Do not interfere with any sealed components on this boiler.

Take note of any warning labels on your boiler.

Your boiler should have the following minimum clearances for Safety and Maintenance (Fig. 4 & 5):-

Top	- 250mm
Left side	- 25mm
Right Side	- 25mm
Front	- 50mm (In Operation)
	- 450mm (For Servicing)

If your boiler is installed in a compartment, do not use it for storage purposes. Do not obstruct any purpose provided ventilation openings.

Flammable materials must not be stored in close proximity to your boiler.

Avoid skin contact when your boiler is in operation, as some surfaces may get hot i.e. pipework, flue.

Ensure that the flue terminal, outside the house, does not become damaged or obstructed, particularly by foliage.

It is important that the condensate drain system is not blocked, modified or damaged in any way as this would affect the operation of your boiler. Your installer should have insulated any exposed pipework.

## 5.0 Care of the Boiler

---

### 5.1 Cleaning the Outercase

1. The painted panels should be wiped with a damp cloth and then dried completely. DO NOT USE ABRASIVE CLEANING AGENTS.

---

### 5.2 Protection & Precautions

1. The boiler incorporates an integral frost protection feature that will operate in both modes. If the boiler temperature falls below 4° C, the boiler will fire until a temperature of 15° C is reached.

2. If a system frost thermostat has been fitted (your installer will be able to advise you), then to operate correctly and protect your system, the gas and electricity must be left on and the appliance set in the central heating mode.

3. The boiler incorporates an integral pump protection feature which monitors the time since the pump last operated and will operate the pump for approximately 1 minute if it has not run in the last 24 hours.

---



## 6.0 Legislation

### 6.1 Installation, Commissioning, Service & Repair

1. This appliance must be installed in accordance with the manufacturer's instructions and the regulations in force. Read the instructions fully before installing or using the appliance.
2. In GB, this must be carried out by a competent person as stated in the Gas Safety (Installation & Use) Regulations.
3. **Definition of competence:** A person who works for a Gas Safe registered company and holding current certificates in the relevant ACS modules, is deemed competent.
4. In IE (Eire), this must be carried out by a competent person as stated in I.S. 813 "Domestic Gas Installations".

**Lifting** - This product should be lifted and handled by two people. Stooping should be avoided and protective equipment worn where necessary. Carrying & lifting equipment should be used as required, e.g. when installing in a loft space.

---

All Gas Safe registered engineers carry an ID card with their licence number and a photograph. You can check your engineer is registered by telephoning 0800 408 5500 or online at [www.gassaferegistered.co.uk](http://www.gassaferegistered.co.uk)

---

The boiler meets the requirements of Statutory Instrument "The Boiler (Efficiency) Regulations 1993 No 3083" and is deemed to meet the requirements of Directive 92/42/EEC on the energy efficiency requirements for new hot water boilers fired with liquid or gaseous fuels:-

Type test for purpose of Regulation 5 certified by:  
Notified Body 0085.

Product/Production certified by:  
Notified Body 0086.

For GB/IE only.

### 6.2 Benchmark Commissioning Checklist

Please ensure that the installer has fully completed the Benchmark Checklist on the inside back pages of the installation instructions supplied with the product and that you have signed it to say that you have received a full and clear explanation of its operation. The installer is legally required to complete a commissioning checklist as a means of complying with the appropriate Building Regulations (England and Wales).

All installations must be notified to Local Area Building Control either directly or through a Competent Persons Scheme. A Building Regulations Compliance Certificate will then be issued to the customer who should, on receipt, write the Notification Number on the Benchmark Checklist.

This product should be serviced regularly to optimise its safety, efficiency and performance. The service engineer should complete the relevant Service Record on the Benchmark Checklist after each service.

The Benchmark Checklist may be required in the event of any warranty work.

## 7.0 Programmer

### 7.1 Introduction

1. The built-in programmer is an electronic 7-day central heating and hot water control, designed to be easy to use and understand. Properly programmed it will help you save energy and create a comfortable environment in your home.

2. For convenience, morning and evening ON/OFF periods have been pre-set in the programmer 'memory' and will be retained, even if the mains power supply is interrupted. Details of these ON/OFF periods are given in the next section, together with step-by-step setting instructions.

3. In run mode, any combination can be set (using the ENTER and COPY buttons) e.g.

Hot Water Programme	C/Heating Programme
AUTO	AUTO
	or ALL DAY
	or 24 HOUR (Continuous)
	or OFF

4. The Promax programmer also offers the following features :

- \* Up to 3 On-Off time periods every 24 hours plus the option of programming different times for each day of the week.
- \* A central heating ADVANCE button allowing an instant switch from OFF to ON or ON to OFF without affecting normal settings.
- \* A hot water BOOST button giving an extra one hour period.

### 7.2 Buttons, Indicators & Symbols

Most of the control buttons on the programmer are dual purpose. They can be used as SET buttons for inputting time of day, ON/OFF times, etc, or as SELECT buttons for using the advance facility and choosing override programme options.

Figure 7 can be used to identify the SET buttons, indicators and symbols.

### 7.3 Setting the Programmer

1. Turn the appliance selector switch to central heating and hot water position.

2. Setting Day and Time

**NOTE:** When setting the day, time of day or switch times, if a period exceeding 60 seconds is allowed to elapse between button presses, the programmer will automatically return to normal RUN mode and any changes made since the last press of the ENTER button will not be saved.

i) Press the SET button so that the SET INDICATOR is pointing to the CLOCK position on the front of the programmer. the DAY OF THE WEEK INDICATOR will now flash (see Fig. 9).

Fig. 7

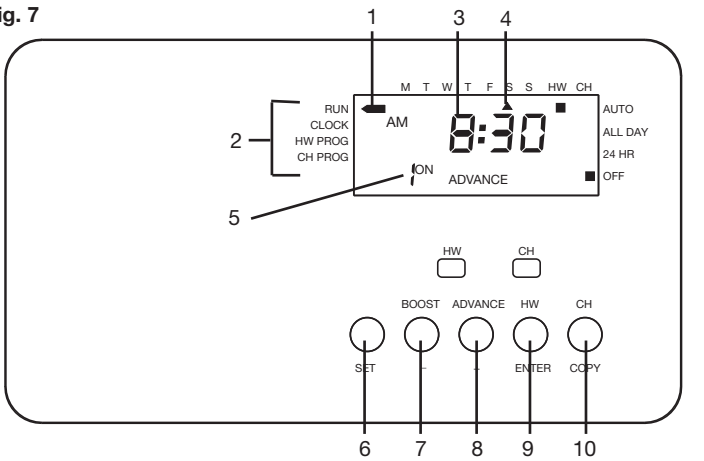

- 1 Set Indicator
- 2 Set Positions
- 3 Time of Day
- 4 Day of Week Indicator
- 5 ON/OFF Switch Period Symbol
- 6 SET Button
- 7 Minus (-) Adjust Button
- 8 Plus (+) Adjust Button
- 9 ENTER Button
- 10 COPY Button

THE RECOMMENDED COMBINATION IS :

Hot Water Programme	C/Heating Programme
ALL DAY	AUTO

The display should then look like this :



Fig. 9



## 7.0 Programmer

Fig. 10



Fig. 11



ii) Use the PLUS (+) or MINUS (-) to move the DAY OF THE WEEK INDICATOR to the current day of the week. Numbers relating to the day of the week are printed along the top of the programmer display, ie  
1=Monday, 2=Tuesday and so on.

iii) Press the ENTER button. The TIME OF DAY will now flash (Fig. 10).

iv) Now use the (+) or (-) BUTTONS to alter the display to the correct time of day making sure that the AM/PM SYMBOL is also correct (FIG. 11).

**NOTE:** By pressing and releasing the (+) or (-) buttons you advance or retard the time in 1 minute steps. If you keep the button depressed the display will fast cycle and the time can be changed more rapidly.

v) Press the ENTER button. Now use the SET BUTTON to return the SET INDICATOR to the RUN POSITION.

### 7.4 Setting 'ON' & 'OFF' Times

**NOTE:** The minimum ON or OFF period that can be set is ten minutes.

1. The integral programmer already has a factory pre-set suite of ON/OFF times in its memory. These are:

Monday to Friday		Central Heating	
Hot Water		1st ON	1st OFF
1st ON	1st OFF	6.30 am	9.00 am
6.00 am	9.00 am	2nd ON	2nd OFF
2nd ON	2nd OFF	12.00 pm	12.00 pm
12.00 pm	12.00 pm	3rd ON	3rd OFF
3rd ON	3rd OFF	5.00 pm	11.00 pm
4.30 pm	11.00 pm		

Saturday / Sunday		Central Heating	
Hot Water		1st ON	1st OFF
1st ON	1st OFF	7.30 am	10.30 am
7.00 am	10.30 am	2nd ON	2nd OFF
2nd ON	2nd OFF	12.00 pm	12.00 pm
12.00 pm	1.00 pm	3rd ON	3rd OFF
3rd ON	3rd OFF	4.30 pm	11.30 pm
4.00 pm	11.30 pm		

2. If these settings do not meet your own requirements then they can be easily changed as follows:

i) Press the SET BUTTON twice so that the SET INDICATOR is in a PROG position (HW or CH). The display will indicate the 'day' and the DAY OF THE WEEK INDICATOR will now flash.

ii) Use the (+) or (-) BUTTONS to move the indicator to the day of the week that you wish to change the times for. Press ENTER. The display will show '1 ON' and then first ON time for that day will flash (see Fig. 13).

iii) Adjust the flashing time as required by using the (+) and (-) buttons then press ENTER. The display will now show '1 OFF' and the first programmed OFF time for the day will flash (see Fig. 14).

iv) This can now be altered in the same way as the '1 ON' time mentioned above.

v) Follow the same procedure for the 2nd and 3rd ON/OFF times remembering to press ENTER after each change to the programme. If you do not wish to alter a particular time then simply press ENTER and the display will move on to the next ON/OFF time leaving the previous one unchanged.

Fig. 12



Fig. 13



Fig. 14



## 7.0 Programmer



**NOTE:** The programmer provides up to three ON/OFF periods each day. If you do not want to use all these, a switch period can be cancelled by programming the ON operation for the same time as the OFF operation e.g. 2nd ON at 12.00 pm and 2nd OFF at 12.00 pm. When the 3rd OFF time has been entered the programmer will display the word COPY and the DAY OF THE WEEK INDICATOR will flash (see Fig.15).

If required these ON/OFF times can now be quickly copied so that they apply to any other day(s) you choose. This avoids separately programming days with identical switching times eg Monday to Friday. If not copying press ENTER and press SET button to return SET INDICATOR to run position.

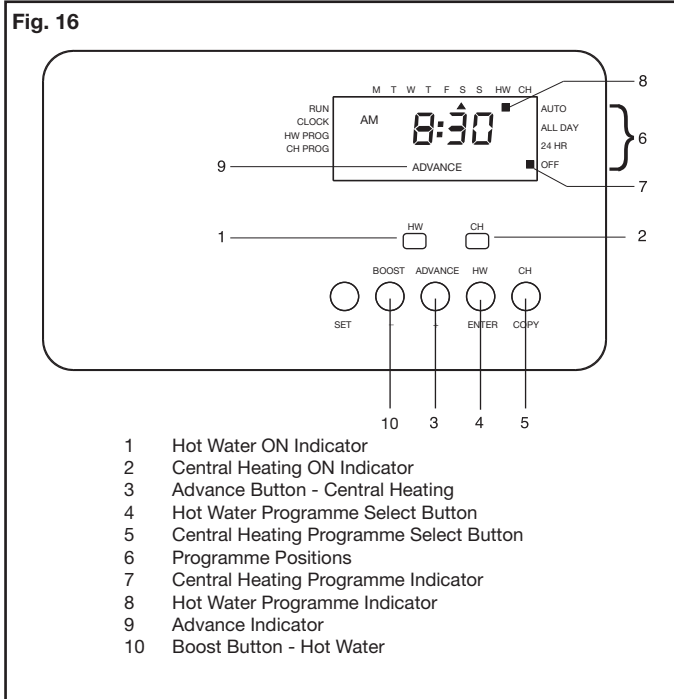

vi) Use the (+) and (-) BUTTONS to move the DAY OF THE WEEK INDICATOR to the next day that you wish the times to apply and press the COPY BUTTON, the display will indicate 'IN'.

Continue in this way until the programme has been copied to all the days that you wish it to apply to.

vii) When you have finished copying simply press ENTER. The word COPY will be replaced with 'day' and the DAY OF THE WEEK INDICATOR will flash.

3. You can now programme those days that require different times to the ones you have just copied by following the same procedure as described at the start of this section, parts ii to v.

### 7.5 Select Buttons, Indicators & Symbols

1. The following diagram (Fig.16) can be used to identify the SELECT buttons and indicators.

### 7.6 Programme Selection

1. The following programmes can be selected for either HOT WATER or HEATING or both together.

- AUTO:** When AUTO is selected the programmer will switch ON and OFF according to the switching times held in the memory, ie up to three ON/OFF periods per day.
- ALL DAY:** When ALL DAY is selected the programmer will switch the system on at the 1st ON TIME and OFF at the 3rd OFF TIME.
- 24 HOURS:** When 24 HOUR is selected the system remains on continuously, ignoring all the time settings.
- OFF:** When OFF is selected the programmer clock continues to operate but the system remains off.

2. To select a hot water programme press the HW PROGRAMME SELECT BUTTON until the HW (HOT WATER) PROGRAMME INDICATOR is pointing to the required programme, e.g. ALL DAY (see Fig. 17)

3. To select a central heating programme follow the same procedure using the CH PROGRAMME SELECT BUTTON.



**NOTE:** When either HOT WATER or HEATING is switched to ON the relevant INDICATOR LIGHT will be illuminated (see Fig.16).

## 7.0 Programmer

Fig. 18

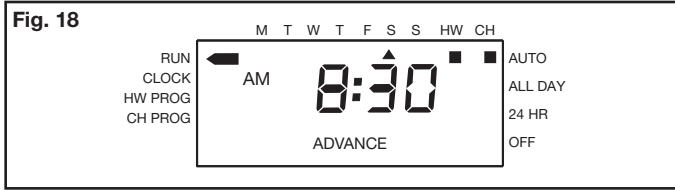
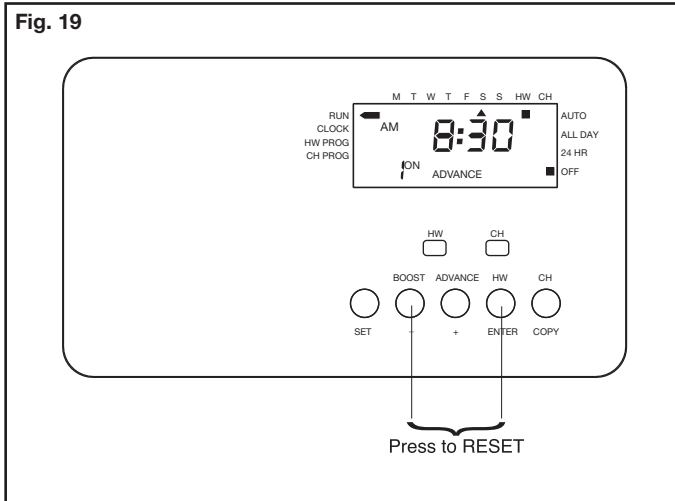

Fig. 19



### 7.7 Using the Advance and Boost Button

1. The ADVANCE facility allows you to bring forward the next heating ON or OFF period without having to alter the programmed ON/OFF times.
2. Press the ADVANCE BUTTON once and release. The word ADVANCE will appear in the display (see Fig.18).
3. If the programmer was originally ON it will now switch OFF and stay OFF until the next programmed ON time.
4. The opposite will apply if the programmer was originally OFF.
5. In both cases the unit will then revert to the normal programme times.
6. If you wish to cancel the advance simply press the ADVANCE BUTTON again and the word ADVANCE will disappear from the display.

**NOTE:** The ADVANCE facility has no effect when the CH PROGRAMME INDICATOR is in either the 24 Hour or the OFF position.

7. Pressing the BOOST button during an unprogrammed time for hot water will give a one hour period of hot water operation.

### 7.8 Programmer Faults

1. Electronic equipment can, in exceptional circumstances, be affected by electrical interference. If the display or switching programme becomes frozen or scrambled, or you wish to revert to the factory pre-set programme, you can RESET the programmer by pressing the MINUS (-) adjust button and the ENTER/HW SELECT BUTTON together (see Fig. 19).
2. After using the RESET procedure you will need to reprogramme the day and time of day plus any changes you wish to make to the factory pre-set programme.
3. The programmer is not user serviceable. DO NOT ATTEMPT TO DISMANTLE IT.
4. In the unlikely event of it developing a fault, contact your Gas Safe Registered Installer or Service Engineer, but before doing so try the RESET PROCEDURE above.
5. Should a replacement programmer be required your Installer can obtain this as Part No. 5117092.

### 7.9 Reserve Battery

1. The programmer is fitted with a NON-RECHARGEABLE LONG LIFE battery which will maintain the programmed ON/OFF settings for a period in excess of 2 years (Part No. 5118231).
2. This is more than sufficient to cover all the expected power interruptions during the life of the unit.

**NOTE:** If a power interruption of more than 48 hours occurs the 'time of day' will need to be re-adjusted once the power is restored.

## 8.0 Warranty & Service

### 8.1 General

---

To make sure your boiler warranty is activated and maintained, it is essential that the:

1. Benchmark checklist is completed by your installer
2. Warranty is registered with Baxi
3. Boiler has an annual service

Please note that failure to adhere to terms and conditions will make your warranty invalid.

### 8.2 Terms of Warranty

---

#### 8.2.1 Standard Warranty Terms and Conditions

---

##### Warranty Registration, Service & Repair

For full terms and conditions, visit [www.baxi.co.uk/terms](http://www.baxi.co.uk/terms).

##### Benchmark Checklist

The Benchmark Checklist will be completed by your installer and records that the boiler has been installed and commissioned correctly. It can be found at the back of the installation and service manual and should be kept in a safe place for the life of the boiler. We will check that the Benchmark Checklist has been completed on an in-warranty visit.

##### Ways to register your warranty

If your boiler is eligible for an extended warranty, your installer may register the product on your behalf and provide you with the relevant documentation. Please check with your installer.

Should this not be the case, you can register your warranty online at [www.baxi.co.uk/registration](http://www.baxi.co.uk/registration)

To activate a **standard two year warranty**, please use one of the following methods:

- Freephone 0800 013 7989 or
- Return the enclosed registration card

## 8.0 Warranty & Service

### Annual Service

A service must be completed every 12 months from the date of installation to maintain your warranty.

This service must be completed by one of the following:

- A Gas Safe registered installer/engineer
- Baxi Customer Support; call us  
0344 871 1525

Please make sure that your engineer has logged the service information at the back of the installation and service manual. You will be asked for your service history on any in-warranty repair visit.

### If you experience a problem with your boiler

For any in or out of warranty repair, Baxi Customer Support is on hand to help you. Call our award-winning team to arrange for one of our nationwide team of Gas Safe registered engineers to visit.

If your product is in warranty, everything is free of charge, subject to our warranty terms and conditions. If it is out of warranty, we can still help and offer a range of options you can choose from to suit your needs.

**Contact Baxi Customer Support 0344 871 1525**

### Opening hours

Monday - Friday, 8.00am - 6.00pm

Weekends and Bank Holidays, 8.30am - 2.00pm

Please note calls may be recorded for training and monitoring purposes.

When contacting Baxi Customer Support, please have the following information to hand:

- Boiler serial number. This can be found on the appliance.
- Proof of purchase if you do not have the boiler serial number.

Please note that for in-warranty repairs, our engineers will ask to see your service history record, completed Benchmark Checklist and details of your installer. These can all be found in the installation and user manual.

## 9.0 ErP Information

### 9.1 Product Fiche - Boiler Space Heaters

Product fiche for combination boilers

<b>Potterton Promax 24 Store ErP</b>		<b>90</b>	<b>115</b>	<b>150</b>
Space heating - Temperature application		Medium	Medium	Medium
Water heating - Declared load profile		XL	XL	XL
Seasonal space heating energy efficiency class		<b>A</b>	<b>A</b>	<b>A</b>
Water heating energy efficiency class		<b>A</b>	<b>A</b>	<b>B</b>
Rated heat output ( <i>Prated or Psup</i> )	kW	24	24	24
Space heating - Annual energy consumption	kWh	20870	20870	20870
	GJ	75	75	75
Water heating - Annual energy consumption	kWh	16	16	19
	GJ			
Seasonal space heating energy efficiency	%	92	92	92
Water heating energy efficiency	%	90	92	77
Sound power level $L_{WA}$ indoors	dB	57	57	57



#### See

For specific precautions about assembling, installing and maintaining, consult the relevant section as detailed on the Contents page.



## 9.0 ErP Information

### 9.2 Package Fiche - Boilers

Package fiche for boilers indicating the space heating energy efficiency of the package

#### Seasonal space heating energy efficiency of boiler

(1)  
 %

#### Temperature control

from fiche of temperature control

Class I = 1%, Class II = 2%, Class III = 1.5%,  
 Class IV = 2%, Class V = 3%, Class VI = 4%,  
 Class VII = 3.5%, Class VIII = 5%

(2)  
 +  %

#### Supplementary boiler

from fiche of boiler

Seasonal space heating energy efficiency (in %)

(3)  
 $(\text{input} - 'I') \times 0.1 = \pm \text{input} \%$

#### Solar contribution

from fiche of solar device

Collector size (in m<sup>2</sup>)

Tank volume (in m<sup>3</sup>)

Collector efficiency (in %)

Tank rating <sup>(1)</sup>

A\* = 0.95, A = 0.91,  
 B = 0.86, C = 0.83,  
 D - G = 0.81

$(\text{'III'} \times \text{input} + \text{'IV'} \times \text{input}) \times 0.9 \times (\text{input} / 100) \times \text{input} = + \text{input} \%$

(1) If tank rating is above A, use 0.95

#### Supplementary heat pump

from fiche of heat pump

Seasonal space heating energy efficiency (in %)

(5)  
 $(\text{input} - 'I') \times 'II' = + \text{input} \%$

#### Solar contribution AND Supplementary heat pump

select smaller value

$0.5 \times \text{input} \text{ OR } 0.5 \times \text{input} = - \text{input} \%$

#### Seasonal space heating energy efficiency of package

(7)  
 %

#### Seasonal space heating energy efficiency class of package

<input type="checkbox"/>	<input type="checkbox"/>	<input type="checkbox"/>	<input type="checkbox"/>	<input type="checkbox"/>	<input type="checkbox"/>	<input type="checkbox"/>	<input type="checkbox"/>	<input type="checkbox"/>	<input type="checkbox"/>
<b>G</b>	<b>F</b>	<b>E</b>	<b>D</b>	<b>C</b>	<b>B</b>	<b>A</b>	<b>A<sup>+</sup></b>	<b>A<sup>++</sup></b>	<b>A<sup>+++</sup></b>
<30%	≥30%	≥34%	≥36%	≥75%	≥82%	≥90%	≥98%	≥125%	≥150%

#### Boiler and supplementary heat pump installed with low temperature heat emitters at 35°C ?

from fiche of heat pump

(7)  
 + (50 x 'II') =  %

The energy efficiency of the package of products provided for in this fiche may not correspond to its actual energy efficiency once installed in a building, as this efficiency is influenced by further factors such as heat loss in the distribution system and the dimensioning of the products in relation to building size and characteristics.

AD-3000743-01

- I The value of the seasonal space heating energy efficiency of the preferential space heater, expressed in %.
- II The factor for weighting the heat output of preferential and supplementary heaters of a package as set out in the following table.

## 9.0 ErP Information

### 9.2 Package Fiche - Boilers (cont)

- III The value of the mathematical expression:  $294/(11 \cdot \text{Prated})$ , whereby 'Prated' is related to the preferential space heater.
- IV The value of the mathematical expression  $115/(11 \cdot \text{Prated})$ , whereby 'Prated' is related to the preferential space heater.

#### Weighting of boilers

$P_{sup} / (Prated + P_{sup})^{(1)(2)}$	II, package without hot water storage tank	II, package with hot water storage tank
0	0	0
0.1	0.3	0.37
0.2	0.55	0.70
0.3	0.75	0.85
0.4	0.85	0.94
0.5	0.95	0.98
0.6	0.98	1.00
$\geq 0.7$	1.00	1.00

(1) The intermediate values are calculated by linear interpolation between the two adjacent values.  
 (2) Prated is related to the preferential space heater or combination heater.

#### Package efficiency

Potterton Promax 24 Store ErP		90	115	150
Temperature control X	%			
Temperature control Y	%			

## 9.0 ErP Information

### 9.3 Package Fiche - Combination Heaters (Boilers or Heat Pumps)

Package fiche for combination heaters (boilers or heat pumps) indicating the water heating energy efficiency of the package

Water heating energy efficiency of combination heater

<sup>①</sup>  
 %

Declared load profile:

Solar contribution

from fiche of solar device

Auxiliary electricity

<sup>②</sup>  
 $(1.1 \times 'I' - 10\%) \times 'II' - 'III' - 'I' = +$   %

Water heating energy efficiency of package under average climate

<sup>③</sup>  
 %

Water heating energy efficiency class of package under average climate

		<input type="checkbox"/>	<input type="checkbox"/>	<input type="checkbox"/>	<input type="checkbox"/>	<input type="checkbox"/>	<input type="checkbox"/>	<input type="checkbox"/>	<input type="checkbox"/>	<input type="checkbox"/>	
		<b>G</b>	<b>F</b>	<b>E</b>	<b>D</b>	<b>C</b>	<b>B</b>	<b>A</b>	<b>A<sup>+</sup></b>	<b>A<sup>++</sup></b>	<b>A<sup>+++</sup></b>
<input type="checkbox"/>	<b>M</b>	<27%	≥27%	≥30%	≥33%	≥36%	≥39%	≥65%	≥100%	≥130%	≥163%
<input type="checkbox"/>	<b>L</b>	<27%	≥27%	≥30%	≥34%	≥37%	≥50%	≥75%	≥115%	≥150%	≥188%
<input type="checkbox"/>	<b>XL</b>	<27%	≥27%	≥30%	≥35%	≥38%	≥55%	≥80%	≥123%	≥160%	≥200%
<input type="checkbox"/>	<b>XXL</b>	<28%	≥28%	≥32%	≥36%	≥40%	≥60%	≥85%	≥131%	≥170%	≥213%

Water heating energy efficiency under colder and warmer climate conditions

Colder: <sup>③</sup> - 0.2 x <sup>②</sup> =  %

Warmer: <sup>③</sup> + 0.4 x <sup>②</sup> =  %

The energy efficiency of the package of products provided for in this fiche may not correspond to its actual energy efficiency once installed in a building, as this efficiency is influenced by further factors such as heat loss in the distribution system and the dimensioning of the products in relation to building size and characteristics.

AD-3000747-01

- I The value of the water heating energy efficiency of the combination heater, expressed in %.
- II The value of the mathematical expression  $(220 \cdot Q_{ref})/Q_{nonsol}$ , where  $Q_{ref}$  is taken from Regulation EU 811/2013, Annex VII Table 15 and  $Q_{nonsol}$  from the product fiche of the solar device for the declared load profile M, L, XL or XXL of the combination heater.
- III The value of the mathematical expression  $(Q_{aux} \cdot 2,5)/(220 \cdot Q_{ref})$ , expressed in %, where  $Q_{aux}$  is taken from the product fiche of the solar device and  $Q_{ref}$  from Regulation EU 811/2013, Annex VII Table 15 for the declared load profile M, L, XL or XXL.



Lined writing area with horizontal lines.



### Warning !

#### If you smell gas

- Do not operate light switches
- Do not operate any electrical equipment
- Do not use a telephone in the hazardous area
- Extinguish any naked flame and do not smoke
- Open windows and doors in the hazardous area
- Turn off the gas supply at the meter
- Warn any other occupants and vacate the premises
- Telephone the National Gas Emergency Service on:-  
0800 111 999

#### Faulty boiler

If it is known or suspected that a fault exists on the boiler, it must not be used until the fault has been corrected by a competent person.

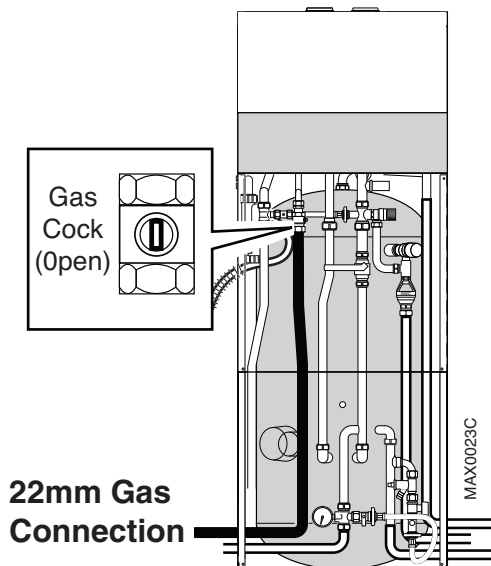

Fig. 20

#### In an Emergency

1. Turn off the electrical supply and turn the selector switch on the facia box to the OFF position.
2. Using a suitable open ended spanner or screwdriver turn the square on the gas tap to the left to isolate the gas supply (Fig. 20).
3. Call your Installer or Service Engineer as soon as possible.

## 12.0 Disposal

### 12.1 Disposal and Recycling

**NOTE:** Removal and disposal of the boiler must be carried out by a qualified person in accordance with local and national regulations.

## Baxi Customer Support



**0344 871 1525**

### Opening hours

Monday - Friday, 8.00am-6.00pm

Weekends and Bank Holidays, 8.30am-2.00pm

Please note calls may be recorded for training and monitoring purposes



**baxi.co.uk**

Register now to activate your warranty:

**[www.baxi.co.uk/registration](http://www.baxi.co.uk/registration)**

For the warranty to be maintained, please make sure...

- 1** Benchmark checklist is completed
- 2** Warranty is registered with Baxi
- 3** The boiler has an annual service

For full terms and conditions, visit [www.baxi.co.uk/terms](http://www.baxi.co.uk/terms). Failure to adhere to terms and conditions will void your manufacturer's warranty.



Baxi  
Brooks House,  
Coventry Road,  
Warwick, CV34 4LL



Please ensure the boiler is installed in accordance with these installation instructions and that you adhere to the Building Regulations.

e&oe

All descriptions and illustrations provided in this document have been carefully prepared but we reserve the right to make changes and improvements in our products which may affect the accuracy of the information contained in this leaflet. All goods are sold subject to our standard Conditions of Sale which are available on request.

CE  
0086



part of **BAXI**