



ProSweep Attachment

Model 99944200553

Operator's Manual

FOR MODELS:

- SRM-2400SB**
- SRM-260SB/261SB**
- PAS-2400**
- PAS-230/231**
- PAS-260/261**
- PAS-2601**
- PAS-265**

ENGLISH

ESPAÑOL

FRANCAIS



WARNING

Read rules for safe operation and instructions carefully. ECHO provides an Operator's Manual with this attachment and a separate Operator's Manual and Safety Manual (if available) with the Power Head. All manuals must be read and understood for proper and safe operation. Failure to do so could result in serious injury.

INTRODUCTION

Welcome to the ECHO family. This ECHO product was designed and manufactured to provide long life and on-the-job dependability. Read and understand this manual included with your attachment. You will find this manual easy to use and full of helpful operations tips and SAFETY messages.

THE OPERATOR'S MANUAL

Read and understand this manual before operation. Keep it in a safe place for future reference. It contains specifications and information for operation, starting, stopping, maintenance, storage, and assembly specific to this product.

THE SAFETY MANUAL

(If available for attachment)

Explains possible hazards and what measures you should take to insure safe operation.

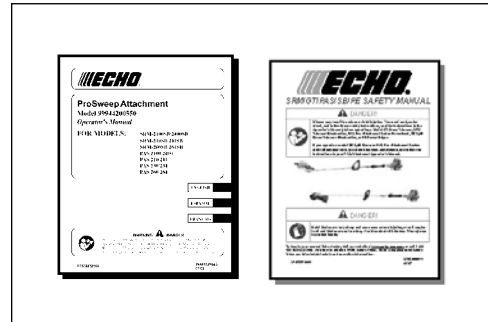

TABLE OF CONTENTS

Introduction.....	2	Maintenance	11
- The Operator's Manual	2	- Skill Levels	11
- Safety Manual	2	- Maintenance Intervals.....	11
Safety	3	- Lubrication.....	11
- Manual Safety Symbols and Important Information	3	- Brush Replacement.....	13
- International Symbols	3	Storage	14
- Personal Condition and Safety Equipment	3	Specifications	14
- Equipment.....	6	Servicing Information	16
Description	7	- Parts/Serial number	16
Contents	8	- Service	16
Assembly.....	8	- ECHO Customer Assistance	16
- ProSweep Gear Housing Assembly to		- Warranty Card.....	16
Lower Shaft Assembly.....	8	- Additional or Replacement Manuals	16
- Power Head Shaft to ProSweep Attachment	9	- Manual Ordering Instructions	16
Operation.....	10		

Specifications, descriptions and illustrative material in this literature are as accurate as known at the time of publication, but are subject to change without notice. Illustrations may include optional equipment and accessories, and may not include all standard equipment.

SAFETY

MANUAL SAFETY SYMBOLS AND IMPORTANT INFORMATION

Throughout this manual and on the product itself, you will find safety alerts and helpful, informational messages preceded by symbols or key words. The following is an explanation of those symbols and key words and what they mean to you.

DANGER

The safety alert symbol accompanied by the word “DANGER” calls attention to an act or condition which **WILL** lead to serious personal injury or death if not avoided.

WARNING

The safety alert symbol accompanied by the word “WARNING” calls attention to an act or condition which **CAN** lead to serious personal injury or death if not avoided.

CAUTION

The safety alert symbol accompanied by the word “CAUTION” calls attention to an act or condition which may lead to minor or moderate personal injury if not avoided.



CIRCLE AND SLASH SYMBOL

This symbol means the specific action shown is prohibited. Ignoring these prohibitions can result in serious or fatal injury.











NOTE









This enclosed message provides tips for use, care and maintenance of the unit.

IMPORTANT

The enclosed message provides information necessary for the protection of the unit.

INTERNATIONAL SYMBOLS

Symbol form/shape	Symbol description/application	Symbol form/shape	Symbol description/application
	Read and understand Operator's Manual.		Fuel and oil mixture
	Wear eyes, ears and head protection		Hot Surface
	Emergency stop		DO NOT smoke near fuel.
	Wear hand protection. Use two handed.		DO NOT allow flames or sparks near fuel.
	Wear slip resistant foot wear.		Safety/Alert

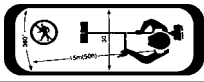
Symbol form/shape	Symbol description/application	Symbol form/shape	Symbol description/application
	Keep feet away from rotating attachment		Thrown objects
	Engine choke control.		Primer bulb
	Carburetor adjustment - Low speed mixture		Ignition ON/OFF
	Carburetor adjustment - Idle speed		Carburetor adjustment - High speed mixture
		Keep bystanders and helpers away 15 m (50 ft.).	

PERSONAL CONDITION AND SAFETY EQUIPMENT

WARNING

ProSweep users risk injury to themselves and others if the ProSweep attachment is used improperly and or safety precautions are not followed. Proper clothing and safety gear must be worn when operating the ProSweep attachment. Failure to do so can result in serious injury.

Physical Condition

Your judgment and physical dexterity may not be good:

- if you are sick,
- if you are taking medication,
- if you have taken alcohol or drugs.

Operate unit only if you are physically and mentally well.

Eye Protection

Wear eye protection that meets ANSI Z87.1 or CE requirements whenever you operate the ProSweep attachment.

Hand Protection

Wear no-slip, heavy duty work gloves to improve your grip on the Pro Attachment Series or Split Boom handles. Gloves also reduce the transmission of machine vibration to your hands.

Hearing Protection

ECHO recommends wearing hearing protection whenever unit is used.

Proper Clothing

Wear snug fitting, durable clothing;

- Pants should have long legs, shirts with long sleeves.
- Wear hair covering to contain long hair.
- DO NOT WEAR SHORTS,
- DO NOT WEAR TIES, SCARFS, JEWELRY.

Wear sturdy work shoes with non-skid soles;

- DO NOT WEAR OPEN TOED SHOES,
- DO NOT OPERATE UNIT BAREFOOTED.

Keep long hair away from engine and air intake. Retain hair with cap or net.

Hot Humid Weather

Heavy protective clothing can increase operator fatigue which may lead to heat stroke. Schedule heavy work for early morning or late afternoon hours when temperatures are cooler.

Vibration and Cold --

It is believed that a condition called Raynaud's Phenomenon, which affects the fingers of certain individuals may be brought about by exposure to vibration and cold. Exposure to vibration and cold may cause tingling and burning sensations followed by loss of color and numbness in the fingers. The following precautions are strongly recommended because the minimum exposure which might trigger the ailment is unknown.

- Keep your body warm, especially the head, neck, feet, ankles, hands and wrists.
- Maintain good blood circulation by performing vigorous arm exercises during frequent work breaks and also by not smoking.
- Limit the hours of operation. Try to fill each day with jobs where operating the unit or other hand-held power equipment is not required.
- If you experience discomfort, redness, and swelling of the fingers followed by whitening and loss of feeling, consult your physician before further exposing yourself to cold and vibration.



Repetitive Stress Injuries --

It is believed that overusing the muscles and tendons of the fingers, hands, arms, and shoulders may cause soreness, swelling, numbness, weakness, and extreme pain in those areas. Certain repetitive hand activities may put you at a high risk for developing a Repetitive Stress Injury (RSI). An extreme RSI condition is Carpal Tunnel Syndrome (CTS), which could occur when your wrist swells and squeezes a vital nerve that runs through the area. Some believe that prolonged exposure to vibration may contribute to CTS. CTS can cause severe pain for months or even years.

To reduce the risk of RSI/CTS, do the following:

- Avoid using your wrist in a bent, extended or twisted position. Instead try to maintain a straight wrist position. Also, when grasping, use your whole hand, not just the thumb and index finger.
- Take periodic breaks to minimize repetition and rest your hands.
- Reduce the speed and force in which you do the repetitive movement.
- Do exercises to strengthen the hand and arm muscles.
- See a doctor if you feel tingling, numbness or pain in the fingers, hands, wrists or arms. The sooner RSI/CTS is diagnosed, the more likely permanent nerve and muscle damage can be prevented.

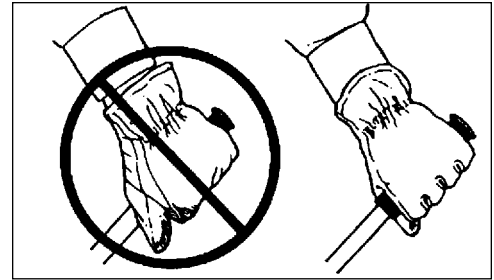

DANGER

Do not operate this product indoors or in inadequately ventilated areas. Engine exhaust contains poisonous emissions and can cause serious injury or death.

Read the Manuals

- Provide all users of this equipment with the Operator's Manual and Safety Manual for instructions on Safe Operation.

Clear the Work Area

- Spectators and fellow workers must be warned, and children and animals prevented from coming nearer than 15 m (50 ft.) while the unit is in use.

Keep a Firm Grip

- Hold the front and rear handles with both hands, with thumbs and fingers tightly encircling the handles.

Keep a Solid Stance

- Maintain footing and balance at all times. Do not stand on slippery, uneven or unstable surfaces. Do not work in odd positions or on ladders. Do not over reach.

Avoid Hot Surfaces

- During operation, the drive shaft housing, attachment bearing housing and muffler cover area may become very hot, too hot to touch. Avoid contact during and immediately after operation.

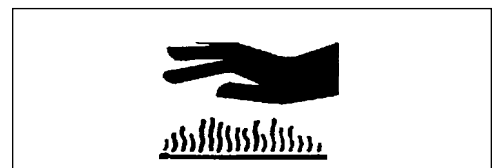

EQUIPMENT



WARNING

Use this attachment with ECHO approved models only. Serious injury may result from the use of this attachment combined with a non approved ECHO product.

Before operation a complete check of the unit must be performed;

- ECHO, INC. will not be responsible for the failure of sweeping devices, accessories and parts which have not been tested and approved by ECHO for use with this ProSweep Attachment.
- Check unit for loose/missing nuts, bolts and screws. Tighten and/or replace as needed
- Inspect ProSweep brushes for damage and that they are firmly secured in place. Replace brushes if damaged or missing.
- Check that the ProSweep attachment is firmly attached and in safe operating condition.

Parts

- Do not use ProSweep attachment if any part is missing or damaged.
- Have repairs done only by an authorized ECHO Service Dealer.
- Do not use any accessory or replacement part unless it is recommended in this Operator's Manual.



WARNING

Moving parts can amputate fingers or cause severe injuries. Keep hands, clothing and loose objects away from all openings.

- **ALWAYS** stop engine, disconnect spark plug, and make sure all moving parts have come to a complete stop before removing obstructions, clearing debris, or servicing unit.
- **DO NOT** start or operate unit unless all guards and protective covers are properly assembled to unit.
- **NEVER** reach into any opening while the engine is running. Moving parts may not be visible through openings.

DESCRIPTION

Locate this safety decal on your attachment. Make sure the decal is legible and that you understand and follow the instructions on it. If it cannot be read, a new one can be ordered from your ECHO dealer. See PARTS ORDERING instructions for specific information.

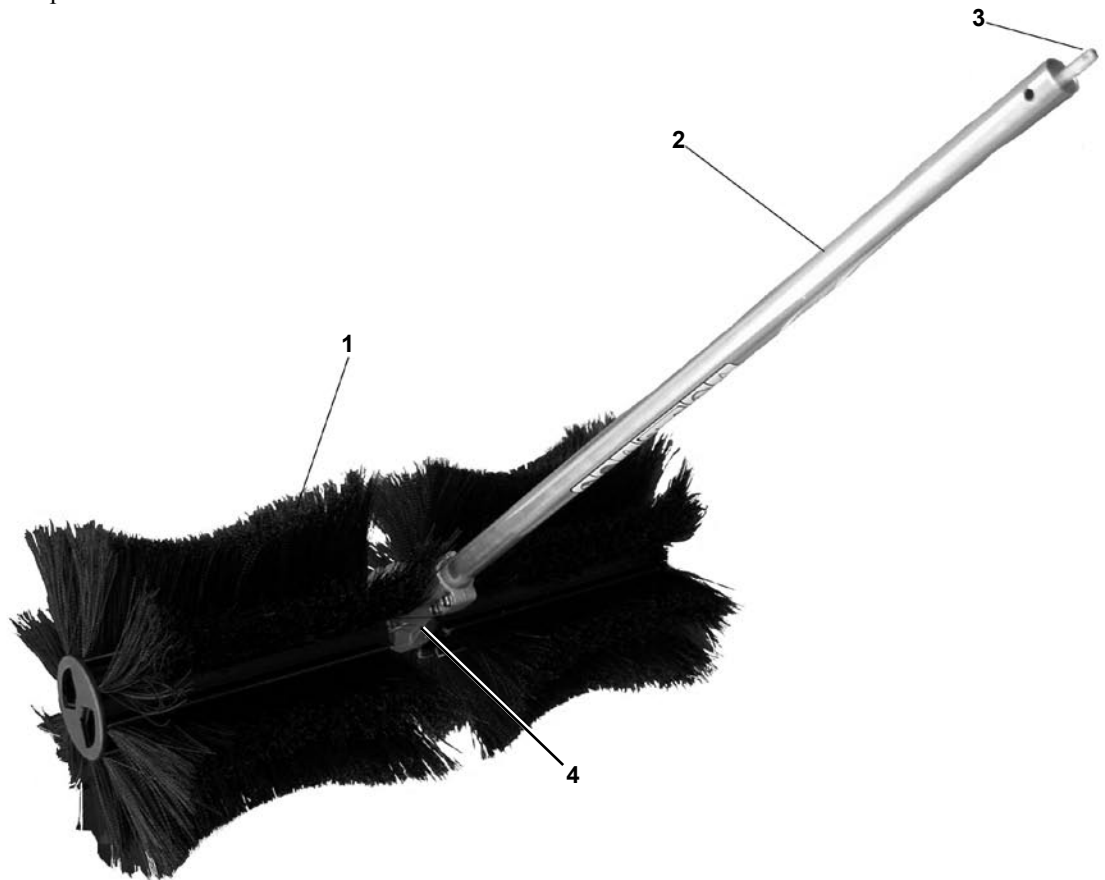

P/N 89016025560

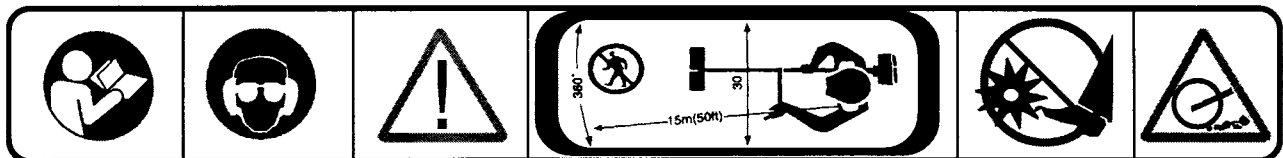

1. **BRUSHES** - Permanently attached to drum holders and come standard with 0.5 mm (0.018 in.) diameter nylon bristles. Optional .7 mm (0.028 in.) diameter brushes are available for fine material sweeping application.
2. **LOWER DRIVE SHAFT ASSEMBLY** - Included separately in the carton and must be assembled to the ProSweep / gear housing assembly. Contains flexible drive cable, outer shaft housing and safety decal.
3. **FLEXIBLE DRIVE CABLE** - Cable end fits into drive shaft coupler of Pro Attachment Series or Split Boom models. Lubricate drive cable every 25 hours with high temperature automotive grease.
4. **BRUSH GEAR HOUSING ASSEMBLY** - Brushes come pre-assembled to the gear housing in the carton. Brushes rotate towards the operator viewed from the operators position.

CONTENTS

After opening the carton, check for damage. Immediately notify your retailer or ECHO Dealer of damaged or missing parts. Use the contents list to check for missing parts.

- ___ 1 - Brushes / Gear Housing Assembly
- ___ 1 - Lower Drive Shaft Assembly
- ___ 1 - Operators Manual
- ___ 1 - Warranty Registration Card
- ___ 1 - Storage Hook Assembly

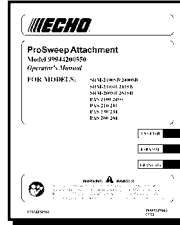

ASSEMBLY



WARNING

Do not perform maintenance or assembly procedures with engine running.

Tools Required: 4 & 5 mm Hex Wrench

Parts Required: ProSweep Gear Housing, Lower Drive Shaft Assembly, PAS or SRM-SB Power Head w/Shaft & Coupling.

PROSWEEP GEAR HOUSING ASSEMBLY TO LOWER DRIVE SHAFT ASSEMBLY

1. Remove vinyl caps from attachment drive shaft.
2. Place brush gear housing assembly on a flat surface with gear housing shaft mount at 45° angle.
3. Remove gear housing locator screw (A) with 4 mm hex wrench.
4. Loosen gear housing mounting bolt (B) with 5 mm hex wrench.
5. Position lower drive shaft (end without serial number decal) into gear housing shaft mount.
6. Align hole in drive shaft housing with gear housing shaft hole (C) and seat lower drive shaft end into gear housing shaft mount. Install and tighten locator screw (A).
7. Tighten gear housing mounting bolt (B).

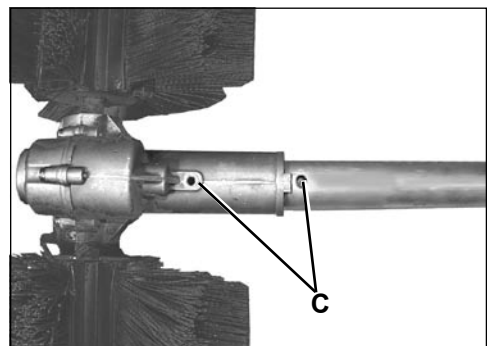

POWER HEAD SHAFT/LOWER SHAFT ASSEMBLY

1. Turn gear housing assembly over so that gear housing mounting bolt (E) faces upward.
2. Pull locator pin (A) out, and turn counter-clockwise 1/4 turn to lock-out position.

CAUTION

Thrown objects hazard. Install lower drive shaft so that gear housing mounting bolt (E) faces upwards. Otherwise debris will be thrown toward user.

3. Remove cardboard spacer from coupler, if necessary.
4. Carefully fit attachment drive shaft assembly into coupler (B) to decal assembly line (C), making sure that the inner lower drive shaft engages upper drive shaft mount.

NOTE

Short couplings fit flush to decal point (F). Long couplings are 4-3/4 in. long, and fit flush to line (C).

5. Rotate locator pin (A) 1/4 turn clockwise to engage lower shaft hole. Insure locator pin is fully engaged by twisting lower drive shaft. Locator pin should snap flush in coupler. Full engagement will prevent further shaft rotation.
6. Secure lower shaft assembly to coupler by tightening clamping knob (D).

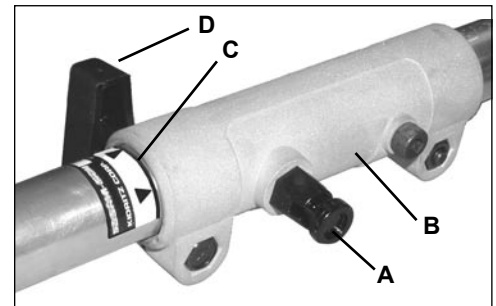
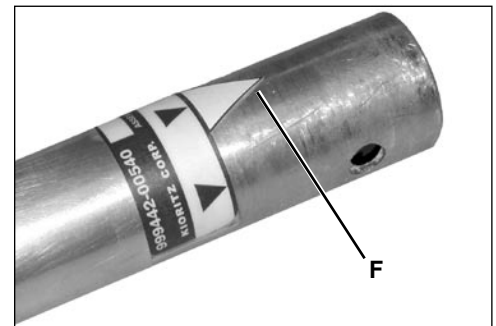
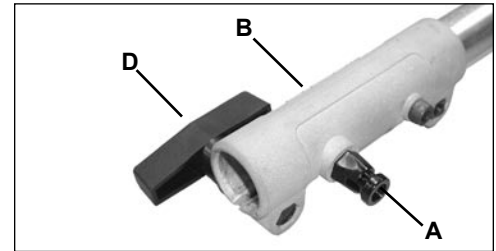

OPERATION



WARNING

Moving parts can amputate fingers or cause severe injuries. Keep hands, clothing and loose objects away from all openings. Always stop engine, disconnect spark plug, and make sure all moving parts have come to a complete stop before removing obstructions, clearing debris, or servicing unit.

NOTE

Refer to your Pro Attachment Series or Split Boom Operator's Manuals for correct engine fueling, starting and stopping instructions.

1. Hold unit on your right side resting sweeper brushes on work surface.
2. Firmly grasp throttle grip with right hand and front handle with left hand.
3. Position ProSweep at an angle to the work surface well out in front of your body.



WARNING

The sweeper brushes rotate towards the operator. Do not operate ProSweep at an angle with brushes close to your body which could result in loss of control and possible serious injury.

4. Accelerate to full throttle and allow brushes to push debris ahead. Sweep to an area where debris can be piled and collected.

IMPORTANT

Extended use of unit at low throttle settings could cause damage to clutch because of clutch slipping.

5. Debris may be swept out and away from corners by turning unit over to reverse brush direction. Grip unit securely using both hands. Operate throttle trigger with thumb of right hand. For extended use, reposition front handle to allow comfortable grip. Return handle to normal position for regular operation.



WARNING

Turning ProSweep over to reverse sweeper drum rotation will cause debris to be swept toward operator. Reduce engine speed, and be alert for unstable footing caused by loose debris.

6. When sweeping wide areas, angle brushes to pile debris in rows; then collect material.
7. Use an angle of 15-30°. This helps direct debris and reduces operator fatigue.



MAINTENANCE



WARNING

Moving parts can amputate fingers or cause severe injuries. Keep hands, clothing and loose objects away from all openings. Always stop engine, disconnect spark plug, and make sure all moving parts have come to a complete stop before removing obstructions, clearing debris, or servicing unit. Allow unit to cool before performing service. Wear gloves to protect hands from sharp edges and hot surfaces.

Your ECHO attachment is designed to provide many hours of trouble free service. Regular scheduled maintenance will help your attachment achieve that goal. If you are unsure or are not equipped with the necessary tools, you may want to take your unit to an ECHO Service Dealer for maintenance. To help you decide whether you want to DO-IT-YOUR-SELF or have the ECHO Dealer do it, each maintenance task has been graded. If the task is not listed see your ECHO dealer for repairs.

SKILL LEVELS

Level 1 = Easy to do. Most required tools come with unit.

Level 2 = Moderate difficulty. Some specialized tools may be required.

MAINTENANCE INTERVALS

Component/System	Maintenance Procedure	Skill Level	Frequency
Drive Shaft	Grease	1	Every 25 hours of use
Gear Housing	Grease	1	Yearly
Brushes	Inspect/Tighten/Replace	1	Before each use
Screws/Nuts/Bolts	Inspect/Tighten/Replace	1	Before each use



WARNING

Always stop engine and disconnect spark plug before performing maintenance procedures, otherwise serious injury may result.

LUBRICATION

Level 1.

Tools Required: 13 mm Open End Wrench, 4 & 5 mm Hex Wrench, Clean Rag

Parts Required: Gear Housing EP "0" or "00" Grease, Drive Shaft POWER BLENDX™

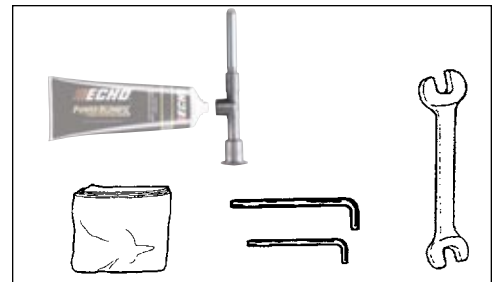

Gear Housing

1. Clean all loose debris from gear housing.
2. Remove screw plug (A) and check level of grease.
3. Add grease if necessary, DO NOT over fill.
4. Install screw plug (A).

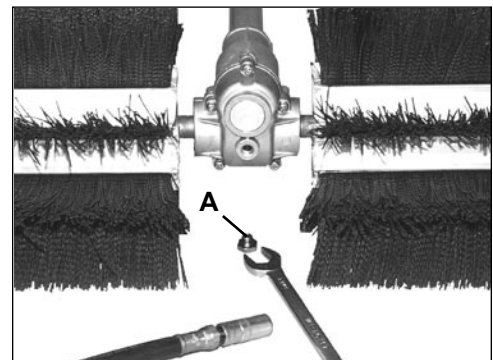

Drive Shaft

IMPORTANT

Lower and upper drive shaft must be lubricated with POWER BLENDX™ grease every 25 hours of operation, otherwise drive shaft assembly overheating and failure can result.

1. Remove gear housing locator screw (A).
2. Loosen gear housing mounting bolt (B).
3. Pull gear box from drive shaft housing.
4. Pull flexible cable from the drive shaft housing, wipe clean and re-coat with a thin coating [15 ml (1/2 oz.)] of POWER BLENDX™.
5. Slide the flexible cable back in the drive housing. DO NOT get dirt on the flex cable.
6. Position lower drive shaft (end without safety decal) into gear housing shaft mount.
7. Align hole in drive shaft housing with gear housing shaft hole (C), and seat lower drive shaft end into gear housing shaft mount. Install and tighten locator screw (A).
8. Tighten gear housing mounting bolt (B).

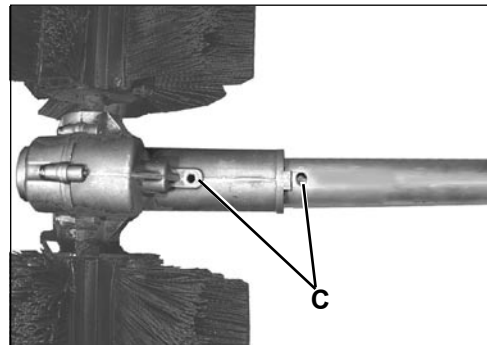
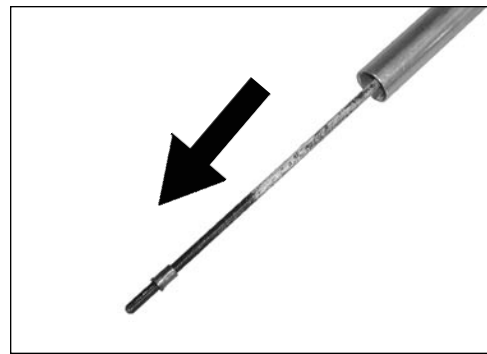

BRUSH REPLACEMENT

Level 1.

Tools Required: 8 mm Open End Wrench, Cross Head Screwdriver

Parts Required: Standard Brush Assy .018 in.
P/N 99944200551 QTY (2)
Optional Brush Assy .028 in.
P/N 25020225661 QTY (2)

Brushes that are broken off, deformed, or worn to within 25.4 mm (1 in.) of the brush holder drum should be replaced for best sweeping efficiency.

1. Locate brush holder access hole (A) near outer drum end.

2. Hold 8 mm nut (B) from turning with open end wrench inserted through drum holder cap. Loosen and remove bolt and lock nut with cross head screwdriver through holder access hole (A).

3. Remove drum cap (C). Slide brush holder drum off square axle shaft.

4. Install new brush holder drum, aligning hole (A) in drum axle with axle shaft hole.

5. Install drum cap, aligning cap holes with axle shaft and brush holder drum holes.

6. Install bolt and locknut. Tighten securely.

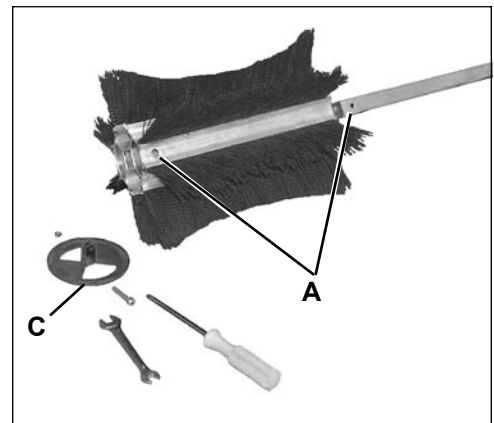
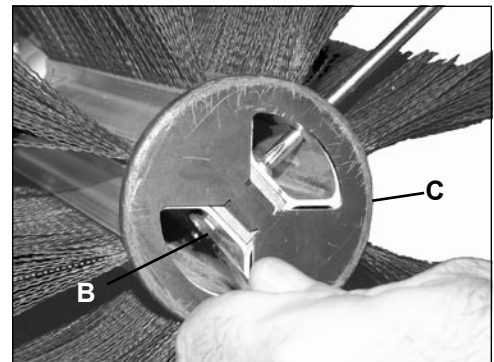
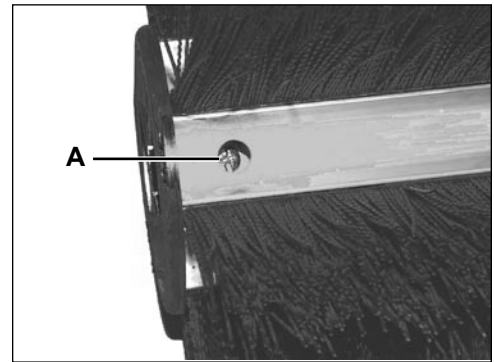

STORAGE

1. Clean ProSweep attachment bristles with water.

IMPORTANT

Do not immerse this attachment in water. Water will enter gear housing and damage gears, bearings and seals.

2. Apply thin coating of oil to metal parts to prevent rust.
3. Lubricate lower shaft assembly with grease. (Refer to Lubrication instructions.)
4. Store ProSweep attachment in a dry place out of reach of children. Do not store attachment with the weight resting on brushes which could bend over a long period of time. Store attachment with lower shaft housing in a horizontal or vertical position to prevent grease loss from open shaft end.

Storage Hook Installation

5. Insert small end of hook into locating hole on attachment shaft.
6. Slide plastic cap onto end of attachment shaft.

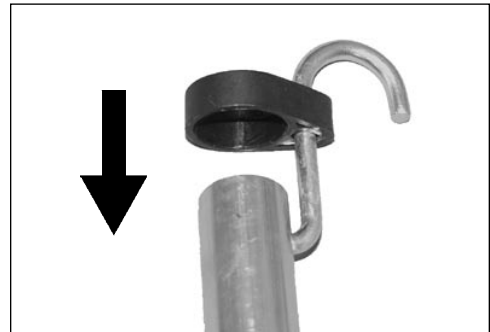
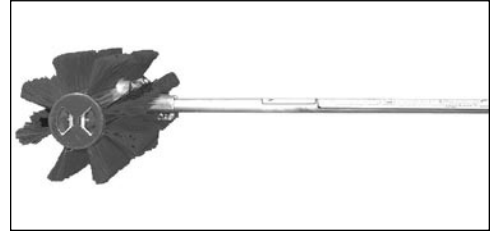

SPECIFICATIONS

ProSweep Attachment : Approved for use on PAS and Split Boom Models

Attachment Length	-----	925 mm (36.4 in.)
Attachment Width	-----	598 mm (23.5 in.)
Attachment Height	-----	280 mm 11 in.)
Weight	-----	5.1 kg. (11.25 lb.)
Drive Shaft	-----	6.35 mm (0.25 in.)
Rotating Direction	-----	Towards the operators viewed from the rear
Brushes	-----	Nylon Bristles 0.7 mm (0.028 in.) Nylon Bristles
Max Sweeping Width	-----	590 mm (23.2 in.)
Gear Case Lubrication	-----	EP "0" or "00" Grease
Gear Reduction Ratio	-----	42.75 : 1
Drive Shaft Lubrcation	-----	POWER BLENDX™
Sweeper Operating (RPM)	-----	210
Engine Wide Open Throttle (RPM) w/attachment	----	7700-8500

NOTE

SERVICING INFORMATION

PARTS/SERIAL NUMBER

Genuine ECHO Parts and ECHO REPOWER™ Parts and Assemblies for your ECHO products are available only from an Authorized ECHO Dealer. When you do need to buy parts **always** have the Model Number and Serial Number of the attachment with you. You can find these numbers on the driveshaft model/serial number label. For future reference, write them in the space provided below.

Model No. _____ SN. _____

SERVICE

Service of this product during the warranty period must be performed by an Authorized ECHO Service Dealer. For the name and address of the Authorized ECHO Service Dealer nearest you, ask your retailer or call: 1-800-432-ECHO (3246). Dealer information is also available on our Web Site. When presenting your unit for Warranty service/repairs, proof of purchase is required.

ECHO CONSUMER PRODUCT SUPPORT

If you require assistance or have questions concerning the application, operation or maintenance of this product you may call the ECHO Consumer Product Support Department at 1-800-673-1558 from 8:30 am to 4:30 pm (Central Standard Time) Monday through Friday. Before calling, please know the model and serial number of your unit to help your Consumer Product Support Representative.

WARRANTY REGISTRATION

You may register your Echo equipment using the warranty registration card or register on-line at www.echo-usa.com. Registering provides a direct link between you and ECHO if we find it necessary to contact you.

ADDITIONAL OR REPLACEMENT MANUALS

Replacement Operator, Safety Manuals, and Parts Manuals are available from your ECHO dealer or at www.echo-usa.com or by contacting ECHO Inc., 400 Oakwood Road, Lake Zurich, IL 60047 (800-673-1558).

Safety Videos are available from your Echo dealer. A \$5.00 shipping charge will be required for each video.



DEALER?

Call
1-800-432-ECHO
or
www.echo-usa.com

CONSUMER PRODUCT SUPPORT

1-800-673-1558
8:30 - 4:30 Mon - Fri C.S.T.

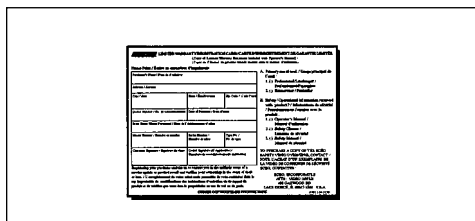

ECHO®

ECHO, INCORPORATED
400 OAKWOOD ROAD
LAKE ZURICH, IL 60047-1564

WWW.ECHO-USA.COM

S069001001/S069999999