



Sykes-Pickavant®

Workshop Solutions

SP THE ORIGINAL

SPECIAL OFFERS

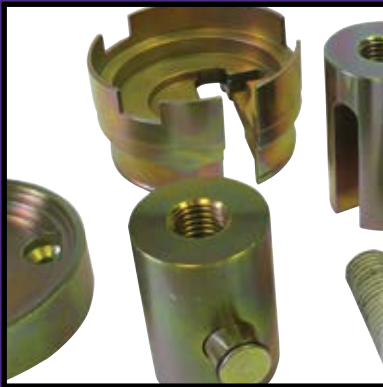

NEW PRODUCTS

INCLUDES BATTERY CARE, BRAKING, COOLING, LIGHTING, SUSPENSION, TORQUE, WORKSHOP TOOLS & MUCH MORE!

JANUARY - MARCH 2014

www.sykes-pickavant.com



'Motorq 399' - 3/4" Push-Thru Torque Wrench

80039900

- 3/4" push-thru sq dr
- 80 - 400 Nm / 59 - 295lbs.ft
- Length: 690mm
- Weight: 2.10kg



OFFER £199.95
SAVE £43.55
 LIST PRICE £243.50

'Motorq 400' - 3/4" Push-Thru Heavy Duty Torque Wrench

80040000

- 3/4" push-thru sq dr
- 150 - 700 Nm / 110 - 516lbs.ft
- Length: 1090mm
- Weight: 6.00kg



OFFER £356.95
SAVE £36.05
 LIST PRICE £393.00

'Motorq 500' - 3/4" Push-Thru Heavy Duty Torque Wrench

80050000

- 3/4" push-thru sq dr
- 300 - 1000 Nm / 221 - 738lbs.ft
- Length: 1470mm
- Weight: 7.00kg



OFFER £359.95
SAVE £42.05
 LIST PRICE £402.00

'Motorq 550' - Stepped 3/4" to 1" Heavy Duty Torque Wrench

80055000

- 1" Sq. Dr (uses 3/4" to 1" stepped convertor)
- 700 - 1500 Nm / 500 - 1000lbs.ft
- Length: 1470mm
- Weight: 10.40kg



OFFER £569.95
SAVE £33.05
 LIST PRICE £603.00



'Motorq' Heavy Duty Torque Multipliers

Features include:

- Single stage epicyclic gears, producing a 5:1 multiplication ratio
- Use with conventional torque wrenches for heavy duty applications
- Supplied with reaction bars, in plastic storage case

NEW
LOWER PRICE

Part No.	Ratio	Input Drive	Max. Input	Output Drive	Output Range	Weight	Price
80060000	5:1	1/2" sq.dr. / 32mm hex	260Nm	3/4"	130 - 1300Nm	4.3kg	£643.00
80065500	5:1	3/4" sq.dr. / 36mm hex	540Nm	1"	270 - 2700Nm	4.5kg	£643.00

'Motorq 20' - 3/8" Push-Thru Torque Wrench 80002000

- 3/8" push thru sq dr
- 4 - 20 Nm / 3 - 15lbs.ft
- Length: 210mm
- Weight: 0.40kg



OFFER £74.95
SAVE £30.00
LIST PRICE £104.95

'Motorq 60' - 3/8" Push-Thru Torque Wrench 80006000

- 3/8" push thru sq dr
- 8 - 60 Nm / 6 - 45lbs.ft
- Length: 305mm
- Weight: 0.60kg



OFFER £99.95
SAVE £25.05
LIST PRICE £125.00

'Motorq 100' - 3/8" Push-Thru Torque Wrench 80010000

- 3/8" push thru sq dr
- 20 - 100 Nm / 15 - 74lbs.ft
- Length: 356mm
- Weight: 0.75kg



OFFER £99.95
SAVE £25.05
LIST PRICE £125.00

'Motorq 200' - 1/2" Push-Thru Torque Wrench 80020000

- 1/2" push thru sq dr
- 40 - 200 Nm / 30 - 148lbs.ft
- Length: 455mm
- Weight: 1.00kg



OFFER £114.95
SAVE £27.80
LIST PRICE £142.75

'Motorq 300' - 1/2" Push-Thru Torque Wrench 80030000

- 1/2" push-thru sq dr
- 60 - 300 Nm / 44 - 221lbs.ft
- Length: 570mm
- Weight: 1.40kg

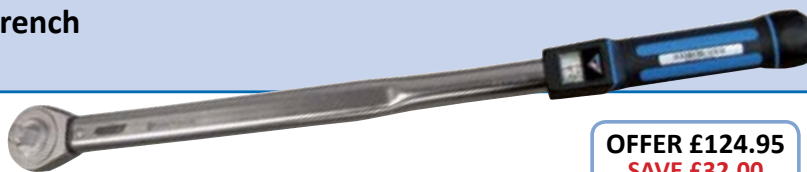

OFFER £124.95
SAVE £32.00
LIST PRICE £156.95

'Motorq 330' - 1/2" Push-Thru Torque Wrench 80033000

- 1/2" push-thru sq dr
- 60 - 330 Nm / 44 - 243lbs.ft
- Length: 690mm
- Weight: 1.40kg

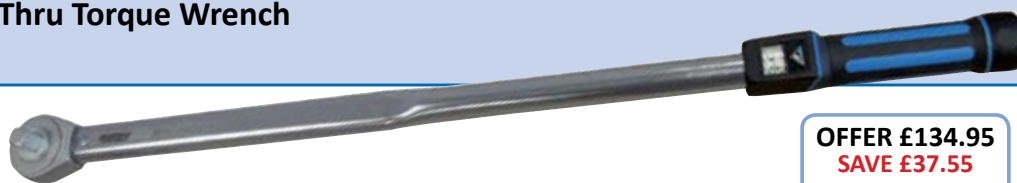

OFFER £134.95
SAVE £37.55
LIST PRICE £172.50

80093500

Universal Digital Torque Angle Gauge

- For turning torqued fasteners through a further angle, as per vehicle manufacturers' specifications
- Simple to use: Calibrate, set angle, mount and use
- Fits onto most ratchets, torque wrenches and power bars
- Magnetic attachment
- One single tool can be used on 1/4", 3/8", 1/2", 3/4" drives
- Indicates increasing angle on LCD display
- Works in both directions of rotation
- LED's glow yellow when close to setting and change to green when desired setting is reached
- Audible notice when setting reached
- LED's glow red when setting exceeded

OFFER £99.95
SAVE £50.00
LIST PRICE £149.95



Scan the QR code to watch a video of the Universal Digital Torque Angle Gauge

sp 03192500

Cooling System Thermometer

- Dual calibrated thermometer (°C and °F)
- Ranges from: -7°C to 120 °C and 20°F to 248°F



OFFER £35.95
SAVE £5.46
LIST PRICE £41.41



sp 33195000

Combustion Leakage Tester

- Accurate and fast diagnosis of cylinder head gasket leaks
- Quick connector for use with 315 / 316 / 317 Series Cap Adaptors
- Suitable for use with both Petrol & Diesel engines
- Supplied with both Standard & Sensitive Reaction Test Fluid (100ml)



£69.95

sp 03190100

319 Series Pump & Gauge Assembly

- British made metal hand pump c/w flexible hose to pressurise cooling system via 319 and older 318 couplings
- Includes dual marked psi / bar pressure gauge

OFFER £99.50
SAVE £30.00
LIST PRICE £129.50



sp 33190000

'319' Series Cooling System Pressure Testing Expansion Plug System Test Kit - Car Kit

- Features a self-testing metal hand pump and precision gauge, with specially designed pressure release valve for safe de-pressurising of cooling systems
- Suitable for Radiators & Expansion Tanks with neck apertures from 21-50mm
- Designed to cover 3 types of system test:
 - Leak Detection
 - Thermostat Operation
 - Temperature Testing

OFFER £325.00
SAVE £20.00
LIST PRICE £345.00



£95.00

sp OTC5609

Cylinder Leakage Tester

- Quickly diagnose internal engine problems such as piston rings, valves and leaking head gaskets
- Dual Gauge 100psi scales c/w 24" flex hose
- Pressure Regulated Manifold
- 10mm, 12mm, 14mm, 18mm Threaded Adaptors

sp 33190500

'319' Series Cooling System Pressure Testing Expansion Plug System Test Kit - HGV Kit

- Designed to cover 3 types of system test:
 - Leak Detection
 - Thermostat Operation
 - Temperature Testing
- Suitable for Radiators & Expansion Tanks with neck apertures from 33-65mm
- Uses air pressure for fast pressurisation & large capacity HGV & Plant Cooling Systems

OFFER £289.00
SAVE £16.00
LIST PRICE £305.00





OFFER £235.00
SAVE £50.00
 LIST PRICE £285.00

SP 331595V2

UPDATED '315' Series Cooling System Test Kit

Recently updated kit to include Mercedes A Class & revised Ford applications

- The '315' series Cooling System Pressure Test programme from Sykes-Pickavant provides extensive coverage for both popular and less popular models and is constantly updated as new models are released.
- More than 20 specialist cooling system cap adaptors are available
- All components of the '315' range are fully compatible with older SP Cooling System Kits and can be used to upgrade previous generations of Cooling System Pressure Test Kits which are fitted with quick-release connectors
- For older systems with a threaded connection, an adaptor is available (03186870)
- **Contents:**
 - Hand Pump with Pressure Gauge and Quick-Release fitting
 - Hose Assembly c/w quick-release fitting
 - 16 x Threaded Cooling System Cap Adaptors
 - 3 x Bayonet Fitting Cooling System Cap Adaptors & 1 x Cap Adaptor wrench
- Comprehensive applications listing provided with each kit

SP 33156100

Cap Adaptor - Mini Cooper S

- Suitable for Mini Cooper S 2002 onwards



£19.95

NEW

SP 03265000

Universal Hose Clamp

- Clamping Range: 8 - 70mm
- 1/4" drive and thumb screw for adjustment



OFFER £25.00
SAVE £5.00
 LIST PRICE £30.00



SP 03250000

Heavy Duty Hose Clamp Plier

- Specially designed for releasing and refitting re-usable hose clips



OFFER £24.95
SAVE £5.00
 LIST PRICE £29.95

SP 03201000

Refractometer - NEW Model - Now with Internal Light

Tests Coolant, Battery Acid, Screenwash and AdBlue using an optical prism test technique

- Now with NEW internal light feature for ease of use in poor light
- Coolant - tests both propylene and ethylene based anti-freeze coolant solutions and determines the freezing point
- Battery Acid - indicates the specific gravity of the battery electrolyte
- Screen Wash - shows the freezing point of screenwash fluids in °C
- NEW - AdBlue – Indicates % concentration of AdBlue additive



OFFER £69.50
SAVE £20.00
 LIST PRICE £89.50

3 FOR 2 DEAL
ALL THREE HYDROMETERS FOR A SPECIAL OFFER PRICE OF £23.90 - SAVE £11.95!

SP 032000SP

Antifreeze & Coolant Hydrometer (03200000)

- For testing Ethylene Glycol
- Temp range: -5°C to -40°C

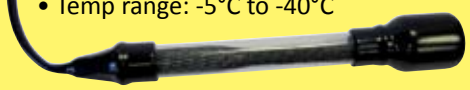

Antifreeze & Coolant Hydrometer (03200200)

- For testing Polypropylene Glycol
- Temp range: -5°C to -40°C

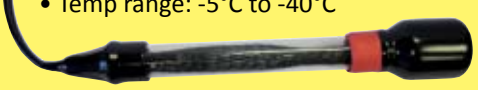

Battery Acid Hydrometer (03200500)

- Professional tester for measuring the state of charge in lead acid batteries
- Measures specific gravity and indicates battery condition with a red / green scale



OFFER £23.90
SAVE £11.95
 LIST PRICE £35.85

Keepower Intelligent Battery Care Battery Charging – Battery Boosting

- Microprocessor controlled for optimum efficiency
- Suitable for all battery types – AGM / GEL / WET etc
- Spark free technology – protects against overload & short circuits
- Intelligent charging regime – 9 modes of charging

Additional Features:

- Flashlight – enables you to clearly see connections
- iPod charger – charge your iPod / Mobile phone via USB connection (XL-Pro only)
- Hook-free clamps – avoids tangled cables
- IP protection rating – suitable for use in damp conditions



88813400 - shown

Includes:

- 'Testing' phase for general battery condition
- 'Soft Charge' for deep discharged batteries
- 'Boost' phase to kick-start battery with low power
- 'Supply' mode – use the charger as a power supply in order to keep battery fully charged

	88813200 Keepower Medium Charger - 8A	88813400 Keepower Large Charger - 15A	88813800 Keepower XL-Pro Charger - 30A
Nominal Battery Charger	12v	12v	12v / 24v
Charge Current	8A	15A	30A / 15A
Battery Size	20Ah – 160Ah	40Ah - 300Ah	3Ah - 600Ah
Max. Output Power	150W	275W	525W
Input Voltage	230v/50hz	230v / 50hz	230v / 50hz
Protection	IP65	IP44	IP44
Charging Cable	2.50mm x 1.8mtrs	2.5mm x 1.8mtrs	4.00mm x 1.8mtrs
Mains Cable	2mtrs	2mtrs	2mtrs
Weight	0.90kg	0.90kg	1.36kg
Price	£195.00	£275.00	£395.00

Extend your batteries' lifetime with Accu-Smart® A totally automatic charger that works for you!

Accu-Smart®, electronic "switched-mode" battery charger, offers a lighter, compact and greater power compared to old chargers using "linear-mode technology" with transformers.

No need for handling or mode selection, the charger works automatically, without external intervention.

- Suitable for Wet (Lead Acid), AGM, Gel & Fleece type batteries
- Each charger is perfectly safe for the electronics of a vehicle, therefore it is not necessary to disconnect the battery from the vehicle before charging it. The charger can effectively retain memory settings within a vehicle while replacing a battery.
- Each charger includes inter-changeable end fittings that best suits the application. Choose from eyelets, cigarette lighter plug and crocodile clamps.



Part No.	Rating	List Price
845122SP	12 volts / 2 Amps	£47.00
845124SP	12 volts / 4 Amps	£62.00

HIGHER PERFORMANCE MODEL
100-1200 CCA

MDX390SP INCLUDES FREE

12v 2A Accu-Smart
Battery Charger (845122SP)

WORTH £47.00

See above for details



MDX390SP

Sykes-Pickavant Battery & Electrical Systems Tester

- Higher Performance model for batteries rated from 100 – 1200 CCA
- Suitable for luxury and 4x4 vehicles with higher level electronic systems
- Determines the state of a Battery and Electrical System
- Simple & Accurate Tests - without heat or sparks being created
- Integrated printer for immediate review with customer

Features:

- User defined printout header
- Suitable for batteries from 100 CCA to 1200 CCA
- Suitable for all battery types inc AGM and GEL

Available Tests:

- 12v batteries & electrical systems
- Starting & Charging system voltage
- Bad Cell detection
- Test discharged batteries down to 1 volt

AGM & GEL Battery Testing	✓
Battery Diagnosis SOH (State of Health)	✓
Temperature Compensation	✓
Starting and Alternator Test	✓
Servo Technology	✓
Voltmeter Mode (0.9 – 16V)	✓
Surface Charge Removal Procedure	✓
Workshop Address on Printout	✓

£449.00



A complete range of high quality Battery Booster Packs, covering a wide variety of applications including: Automotive, Agriculture, Plant, HGV, Marine & Aviation

All Sykes-Pickavant Pro-Start booster packs are perfectly safe for the on-board electronics on modern vehicles and are compatible with Petrol, Diesel & Hybrid vehicles



PRO-START & PROPULSTATION BOOSTER PACKS INCLUDE LIFETIME CASE WARRANTY & 2 YEAR BATTERY WARRANTY

Features:

- AGM internal batteries deliver high amperage instantaneously
- Double insulated starting cables – 1.30 / 1.35 mtrs length
- Illuminated voltmeter indicates booster charge level, booster & alternator function
- Internal fuse protects against short circuits
- Curved jaw clamps, fully insulated – blue clamp with LED lamp for safe use in the dark*
- Single-piece, moulded case – shock resistant (lifetime warranty on case)

Specifications:

NEW

*Excludes 861044SP

Technical	Pro-Start 440 861044SP	Pro-Start 700 861001SP	Pro-Start 800 861002SP	Pro-Start Plus 1400 761001SP	Pro-Start Plus 1600 761006SP	Pro-Start Plus 2400 760008SP
Voltage	12v	12v	12v	12/24v	12/24v	12/24v
Cranking Amps	440	700	800	1400/700	1600/800	2400/1200
Peak Amps	1170	1860	2370	3720/1860	4740/2370	6200/3100
Price	£200.00	£275.00	£355.00	£650.00	£860.00	£1280.00

PROPULSTATION Booster Pack complete with Docking Station Eliminates the risk and frustration of an uncharged booster pack!

- Always in the right place
- Always charged 100%
- 3 times longer lifetime

THE BATTERY - This has an exceptionally high capacity to accumulate and disperse high-amperage energy. It uses pure lead plates and is an AGM (absorbed glass mat) type battery.

THE HOUSING - Robust shell case design with 5mm shatterproof polyethylene ensures a high level of shock and daily use resistance.

THE CABLES - Long and flexible with a double insulation offer a perfect resistance to extreme conditions.

THE CLAMPS - Robust, wide-opening clamps which are fully insulated and have a copper trace carrying the current to both of the bronze jaws and protecting the powerful spring against over-heating.



Choose from:

- **AC model:**
Supplied with mains AC charger for workshop / show room use
- **DC model:**
Supplied with 5m cable and one-way diode for vehicle use

Specifications:

Technical	Propulstation 521001AC	Propulstation 521001DC	Propulstation 521002AC	Propulstation 521002DC	Propulstation 520006AC	Propulstation 520006DC	Propulstation 520008AC	Propulstation 520008DC
Voltage	12v AC	12v DC	12v AC	12v DC	12/24v AC	12/24v DC	12/24v AC	12/24v DC
Cranking Amps	700	700	800	800	1600/800	1600/800	2400/1200	2400/1200
Peak Amps	1860	1860	2370	2370	4740/2370	4740/2370	6200/3100	6200/3100
Price	£456.00	£415.00	£520.00	£480.00	£1100.00	£1100.00	£1520.00	£1530.00

NEW



Propulstation Docking Station - DC Model

- One way diode to connect to the vehicle's battery

Propulstation Docking Station - AC Model

- Provided with an automatic electronic 12v charger to be connected to the mains

Technical	Propulstation Docking Station 5200AC12	Propulstation Docking Station 5200DC12	Propulstation Docking Station 52AC1224	Propulstation Docking Station 52DC1224
Model Supported	521001AC / 521002AC	521001DC / 521002DC	520006AC / 520008AC	520006DC / 520008DC
Price	£160.00	£120.00	£240.00	£240.00

GLOW PLUG & INJECTOR SERVICE

SP 017500V2

UPDATED Diesel Injector Seat Cleaner Set

- Cleans injector seats and chambers when changing or reconditioning diesel injectors
- Helps to avoid blow-back due to poorly seated injectors
- Now includes:
 - Removal tool for copper washers
 - Injector blanking plugs to avoid debris entering the cylinders
 - Wire brush cleaning set for chamber walls
 - Centralising stem to improve correct cleaning seating angle



OFFER £175.00
SAVE £44.00
LIST PRICE £219.00

SP 08565000

Combined FSI / PD / Common Rail Injector Puller & Service Tool Kit for VAG Group

- Suitable for VW, Audi, Seat and Skoda with direct injection engines and engines with pump-injector units
- For assembling and removal of FSI injectors
- Equivalent to VW OEM T10133 + T10163

OFFER £99.95
SAVE £25.05
LIST PRICE £125.00



SP 08593000

Glow Plug Removal Kit

- For removing damaged and broken glow plugs from cylinder heads
- Ideal for use where a glow plug has sheared off just below the hex, or flush with the cylinder head
- Removes 8mm & 10mm glow plugs (M8 x 1.0 thread or M10 x 1.0 thread)
- Comprehensive kit includes all necessary adaptors, centering and thread cleaning tools to safely remove the damaged glow plug without damaging the cylinder head

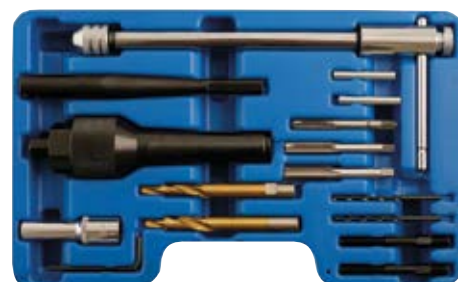

OFFER £149.95
SAVE £35.00
LIST PRICE £184.95

SP 08581000

Diesel Injector Seal Extractor

- Designed to remove the copper injector base seal when it has become stuck in the cylinder head
- Simple adjustment – expands from 6.4mm to 8.0mm
- Speed of use – no more fiddling with picks, hooks etc trying to retrieve stuck seals & washers



OFFER £55.00
SAVE £14.95
LIST PRICE £69.95

SP 08581500

Heavy Duty Injector Washer Removal Tool

- Tapered threaded rod with Slide Hammer, for retrieving washers from the injector seat
- Suitable for both modern common rail & older applications
- Car / LCV / HGV

OFFER £55.00
SAVE £14.95
LIST PRICE £69.95



SP 08585000

Heavy Duty Slide Hammer Injector Remover Kit

- Heavy Duty Slide Hammer puller for removal of Bosch, Delphi, Denso and Siemens injectors
- Features a flexible u-joint adaptor for access in restricted areas
- Includes: 6 x Injector adaptors (M14-M27), 4 x Injector Solenoid removers (M25-M30) and 2 x Nozzle Extractors (6mm & 7mm)

OFFER £235.00
SAVE £60.00
LIST PRICE £295.00



SP 08550000

Injector Puller for Mercedes CDI (Bosch) Injectors

- Slide Hammer with special CDI puller
- Specially designed contact area on the puller, to centre the impact of the slide hammer, maximise the impact force and minimise the risk of damage



OFFER £79.00
SAVE £20.00
LIST PRICE £99.00



Scan the QR code to watch a video of the Injector Puller



Hydraulic Injector Puller Systems

- A NEW concept for the removal of stubborn injectors
- Provides controlled force to aid the removal of seized injectors where there is insufficient access for traditional slide hammers
- Uses a multi-position frame, with adjustable legs of different lengths and a selection of mounting adaptors to allow alignment of the tool with the injectors on a wide variety of modern diesel engines
- The combination of variable leg lengths and selection of the appropriate adaptor for the cylinder head, allows the tool to be correctly positioned on most cylinder heads
- Supplied with injector adaptors for most modern injector types – M14 | M16 | M17 | M20 | M25 | M27

185800SP1

Hydraulic Injector Puller Kit

- 10 tonnes Hydraulic Hollow Cylinder provides the force – use with standard hydraulic pump (not supplied)

£995.00



185810SP1

Mechanical Hydraulic Injector Puller Kit

- As per 185800V2 kit above but includes a mechanical hydraulic ram
- Allows use of the kit without the need for a separate hydraulic pump

£1195.00



185800PP1

Hydraulic Injector Puller Kit with Hydraulic Pump

- As per 185800SP kit above but includes aluminium bodied hand pump - 2 Speed, 10,000psi fitted with gauge, hydraulic hose and 3/4" hydraulic coupler

£1350.00

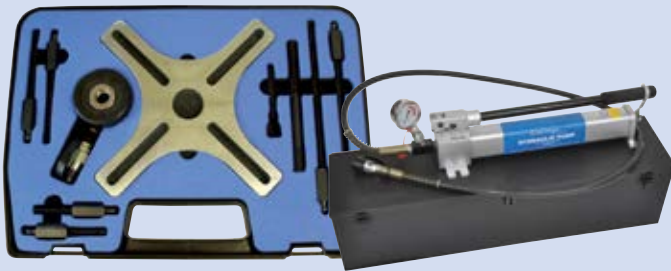

SPECIAL DEAL!

PURCHASE ANY ONE OF THESE THREE KITS AND RECEIVE A

FREE

DIESEL INJECTOR SEAT CLEANER SET (017500V2)

WORTH £219.00

See page 7 for details

18582500

M9R Renault Adaptor Kit for 1858 Series

- Useful additional plate and posts when working on M9R engines

£35.00



18583000

PSA Adaptor Kit for 1858 Series

- A bespoke add on kit for use on PSA 2.0 & 2.2 litre HDi diesel engines

£65.00



sp 08085000

Suspension Wear Indicator

- An innovative tool for detecting suspension and axle joint wear
- For detecting faults in:
 - Wheel bearings
 - Steering gear and links
 - Stabilizers, bushes & ball-joints
 - Suspension joints & suspension struts
- The tool creates a rocking motion in any direction (forward angle, side angle etc) in order to detect movement in steering and suspension components

OFFER £35.95
SAVE £37.00
LIST PRICE £72.95



Scan the QR code to watch a video of the Suspension Wear Indicator



sp 08770000

Universal Press Support Block

- Universal Support for use with a workshop press
 - Three point contact guarantees a perfect, safe support
 - Easily press bearings on a wide variety of suspension arms
- Features:
- Adjustable height anvil bolts
 - Swivel element for added versatility
 - Safety Alignment brackets for security on press

OFFER £239.00
SAVE £60.00
LIST PRICE £299.00



sp 08780000

Universal Press & Pull Sleeve Kit - Car / LCV Kit

- Universal tool set for extracting and drawing-in of bushes, bearings, seals etc
- Contains 20x Press Sleeves in 2mm diameter steps
- Inside Diameter Range: 34 - 72mm
- Outside Diameter Range: 44 - 82mm
- 4x Step Plates / 4x Pulling Spindles with thrust bearings
- Supplied in moulded storage case
- Kit can be used on its own or with either the Universal Press Frame (187000V2) or the Universal C Clamp (18780200)
- Can also be used in conjunction with model specific press piece sets or the standard workshop press

OFFER £379.00
SAVE £166.00
LIST PRICE £545.00



sp 08120000

Universal Wheel Bearing Kit

- Universal set for the removal and installation of flanges and wheel bearings, without the need for dismantling of suspension struts or wheel hubs
- For direct application on the vehicle
- Supplied in storage case

OFFER £245.00
SAVE £54.00
LIST PRICE £299.00



sp 08080000

Universal Suspension Arm Lever

- For lowering of the suspension arms and separation of suspension components
- Reduced effort required, due to unique design using leverage and body weight
- Adjustable swing point allows for variable LH & RH applications

OFFER £124.95
SAVE £74.05
LIST PRICE £199.00

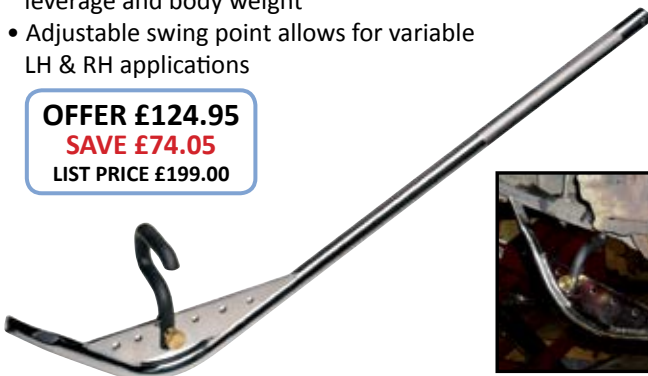

sp 187000V2

Universal Press Frame c/w SP 12 tonne Hydraulic Ram

- Updated unit to provide greater power
- Allows easier operation - 50% more capable using the SP 12 tonne Hydraulic Ram
- Now includes adaptor ring for use with Universal Press & Pull Sleeve Kit (08780000 - see above)

OFFER £245.00
SAVE £54.00
LIST PRICE £299.00





Scan the QR codes to watch a video of the Mondeo Rear Bush Tool Kit



Removal



Installation

NEW LOWER PRICE

SP 08730400

Mondeo Rear Bush Tool Kit

- Individual press piece set for dismantling and installing the rear wishbone / trailing arm bush
- Suitable for:
 - Rear Ford Mondeo 2007-
 - Ford Mondeo (wishbone) Estate 2000 - 2007
 - Ford S-Max & Galaxy 2006-
 - Volvo XC70 & V70 2007-
 - Volvo XC60 2008-
 - Volvo S60 & V60 2010-



ON CAR SOLUTION

OFFER £375.00
SAVE £20.00
LIST PRICE £395.00



SP 187512V2

Suspension Ball Joint Removal Kit for LCV - Opel Movano / Renault Master / VW T4

- Set of model specific tools for the dismantling and installation of suspension ball joints on the vehicle
- Kit for Upper and Lower Ball Joint removal and installation
- Contents:
 - 187000V2 - Universal Press Frame with 12 tonne Hydraulic Power Ram
 - 187502V2 - Press Piece Set - Combined Set for Movano / Master / VW T4



OFFER £599.00
SAVE £190.95
LIST PRICE £789.95

SP 18741300

Suspension Ball Joint Removal Kit - Mercedes Sprinter / VW Crafter - LT

- Set of model specific tools for the dismantling and installation of suspension ball joints on the vehicle
- Kit for Suspension Ball Joint removal and installation
- Contents:
 - 187000V2 - Universal Press Frame with 12 tonne Hydraulic Power Ram
 - 18740300 - Press Piece Set - Suspension Joints for Mercedes Sprinter 1996- and Volkswagen Crafter / LT



OFFER £399.00
SAVE £225.95
LIST PRICE £624.95

SP 08760300

Golf V Control / Trailing Arm Bush Kit

- Heavy Duty mechanical kit for replacing and removing control / trailing arm bushes
- Suitable for:

<ul style="list-style-type: none"> - VW Golf V, VI 2003- - VW Golf Plus 2005- - Audi A3 2003- - Audi TT 2006- - VW Eos 2006- - VW Jetta III, IV 2005- - VW Passat 2005- - VW Tiguan 2007- - VW Touran 2003- 	<ul style="list-style-type: none"> - VW Scirocco 2008- - VW Sharan 2010- - Seat Altea / Leon 2004- - Seat Toledo 2004 - 2009 - Seat Alhambra 2010- - Skoda Octavia 2004- - Skoda Superb 2008- - Skoda Yeti 2009-
--	--



£239.00



SP 08760200

VW Polo Front Control Arm Bush Tool

- For removal and installation of the rear bush on the front control arm, as fitted on
 - VW Polo IV - 2001-
 - Seat Cordoba III - 2002-
 - Skoda Fabia - 1999-



OFFER £149.50
SAVE £33.45
LIST PRICE £182.95

READ MORE IN THE
JANUARY ISSUE OF
PMM MAGAZINE

sp 08254500

Ford Transit Hub & Front Wheel Bearing Remover Kit

- New tool for Ford Transit Mk6 & Mk7 Hub and complete front wheel bearing removal
- Features a heavy duty slide hammer which operates in two directions to achieve multiple operations in one tool
- Provides three different solutions in one kit:
 - Can be used as a traditional hub puller
 - Use the slide hammer in the reverse direction to remove the outer bearing race
 - Remove the stubborn inner bearing race
- Designed and manufactured in the UK

**3 IN 1
TOOL**



Inner Bearing Race Removal

£330.00



Hub Removal



Outer Bearing Race Removal

Scan the QR codes above to watch a video of the three different solutions this tool provides



Scan the QR code to watch an overview video of the Ford Transit Hub & Front Wheel Bearing Remover Kit

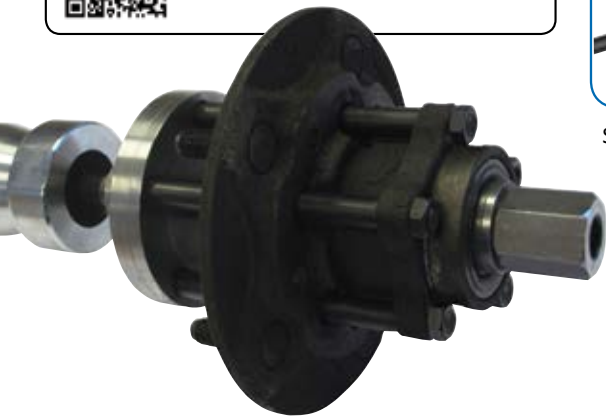

sp 05050000

Land Rover Drop Arm Puller

- Extra heavy duty puller for the removal of drop arms from the toughest of vehicle applications
- Ideal for Land Rover Discovery 1 & 2, Range Rover P38, Land Rover Defender and Ford Transit applications
- The puller is designed to be used with the steering box already removed from the vehicle
- Includes a force screw allowing a technician to effectively shock the drop arm to become loose from the steering box
- Jaw spread capacity - 60mm
- Jaw reach capacity - 80mm



£199.00



Scan the QR code to watch a video of the Land Rover Drop Arm Puller

sp 08041000

VW Alloy 4 Link Suspension Bolt Remover Set

- Simple tool to use with 'Vibro-Impact' air hammer (90206000 - see page 13) when bolt ends protrude from housing
- Sleeve guides the impact end to free off and push bolt through the housing
- Extension adaptor for removing bolts deep in the housing



£39.95

sp 08042000

Specialist VW Alloy 4 Link Suspension Bolt Remover Set

- Specialist kit for dealing with the tightest of bolts
- Can be used with 'Vibro-Impact' air hammer (90206000 - see page 13)
- Includes specialist drills, drill guide and remover bits for removal of the tightest bolts where normal kits fail



OFFER £99.95
SAVE £23.00
LIST PRICE £122.95





Sykes-Pickavant are committed to providing a comprehensive GEN2 Solution, with continuing development of the program and enhancing our position as UK market leader

Designed to distribute pressing force evenly through the outer bearing race and also allows for the suspension leg to remain in-situ on the vehicle when fitting new bearings



COMBINATION KITS: Massive savings over cost of purchasing individual kits

Part No.	Size	Applications	Price
08128000	78, 82 mm	Ford / Volvo / Land Rover / Mazda Combined Kit See below for individual applications	£425.00
08129000	62, 66, 72, 85mm	VW Group See below for individual applications	£725.00 SAVE £70.00
081220V2	62, 66, 72, 78, 82, 85mm	All Sizes Master Kit See below for individual applications	£1215.00

AVAILABLE KITS:

Note: Spare Parts are available for all kits via our website and new catalogue

Part No.	Size	Applications	Price
08123500	62mm	Audi A2, VW Lupo (Front)	£169.95 SAVE £75.05
08124500	66mm	Skoda Fabia, VW Fox (Front), Polo	£169.95 SAVE £75.05
08125500	72mm	Audi A1, Audi A2, Seat Cordoba, Ibiza, Skoda Fabia, Roomster, VW Polo (Front), VW Fox with PAS (Front)	£169.95 SAVE £75.05
08126500	78mm	Ford Focus II, C-Max, Volvo C30, C70, S40, V50 (Front), Mazda 3	£275.00
08128500	82mm	Ford Mondeo, Galaxy, S-Max, Land Rover Freelander 2, Volvo S80, V70, XC60, XC70	£295.00
08127500	85mm	VW Multivan, Touareg, Transporter (Front / Rear)	£325.00

UPGRADE KITS

The kits below contain the necessary parts to upgrade any existing 62, 66 or 72mm kit, to cover any of the other two sizes, without unnecessary duplication of parts. Upgrade kits are supplied in cartons, to fit within the toolbox of one of the standard kits. Each Upgrade Kit includes 2 x Back Plates and 2 x Adaptors



Scan the QR code to watch a video of the GEN2 Bearing Tool

08123000

GEN2 Bearing Removal Tool Kit - 62mm UPGRADE KIT

OFFER £99.95
SAVE £72.55
LIST PRICE £172.50

08124000

GEN2 Bearing Removal Tool Kit - 66mm UPGRADE KIT

OFFER £99.95
SAVE £72.55
LIST PRICE £172.50

08125000

GEN2 Bearing Removal Tool Kit - 72mm UPGRADE KIT

OFFER £99.95
SAVE £72.55
LIST PRICE £172.50

High quality air tools that set the standard for Torque!



90204500

- Impact wrench with a smart design and ergonomically designed handle
- Single-switch can be changed for easy forward or reverse operation
- Easily adjustable torque regulator
- Can be configured for right and left handed use
- Composite body

Impact Wrench Specifications:

Part No.	Drive	Max Torque Nm (Reverse)	Torque Nm (Fwd)	Noise (dBA)	Air Consumption (l / min)	Weight (kg)	Price
90201000	1/2"	1600	1084	94.2	135	1.8	£179.00
90201500 (Mini)	1/2"	680	500	93.5	130	1.08	£169.00
90202000	3/4"	2600	2000	97	210	3.2	£499.00
90202500	3/8"	680	500	93.5	130	1.08	£169.00
90203500	1/4"	90	90	98.2	105	0.9	£139.00
90204500	1"	3100	2200	110	305	6.8	£849.00



90201500



90201100
Rubber Boot (For 90201000)

- Protects gun from accidental damage

*Impact wrench not included

£16.99

90210000

Signal Hose - 10mm (3/8")

- Length: 10 metres
- High-visibility hose to reduce trip hazard
- Abrasion resistant outer cover
- Working temp range -40°C to +65°C
- Working pressure 300psi
- Break pressure 1000psi
- N.B. Hose supplied without fittings



£29.95



90205000
Air Drill

- 3/8" drive - 500rpm
- 2 component housing
- Soft handle
- Quick release chuck (13mm)
- Forward / reverse switch

£149.00

90206000

'Vibro-Impact' Air Hammer

- Allows for the controlled application of force via air powered impact blows
- Built-in shock absorber minimises risk of damage to components
- Loosens seized components by gradually increasing the force applied



Scan the QR code to watch a video of the 'Vibro-Impact' Air Hammer

OFFER £275.00
SAVE £60.00
LIST PRICE £335.00

085900V2

Vibro Impact Glow Plug Remover Set

- For the safe, effective removal of 8, 9, 10, 11 & 12mm glow plugs
- Uses controlled impact torque to create vibration in order to loosen seized glow plugs
- The Vibro-Impact tool 'loosens' the seized glow plug, making it safe and easy to remove without the risk of broken plugs and / or damaged cylinder heads
- Supplied with special long-reach glow plug sockets, long & short extensions and universal joint for ease of access



OFFER £215.00
SAVE £44.00
LIST PRICE £259.00

90207000

Air Die Grinder

- Vibration absorbing handle
- Swivel exhaust and stepless trigger
- Can also be used for carbide cutters through high precision cycling



£64.99

WINTER WARMER!

**INCLUDES
SP INDUCTION HEATER +
& COIL KIT FOR
£645.00**

(960200SP - UK / 960201SP - EU)

Contains 8 x popular sizes of interchangeable coils



96015000

SP 960200SP

**SP Induction Heater +
with Coil Kit (96015000)**

The SP Induction Heater + is a redesign and upgrade of the popular Mini-Ductor II, and uses new engineering technology for increased energy efficiency and ease of use.

Now you can use the power of technology with invisible heat to quickly release corroded or seized components and other metallic parts. All without the damage normally associated with gas torches. Heats in seconds!

Key features of the SP Induction Heater +

- Operates cooler for better efficiency, handling and product longevity
- Longer operating cycle time
- Carry Case; with storage for all attachments, fits in tool chests for security
- Integrated CE filter improves handling of product
- Specifically designed for the UK/EU: 230v/6 amp/1000 watt – with full CE certification
- LED work light illuminates work area
- 1 year warranty - Parts/Labour
- A true 1,000 watts max power available
- Kit includes rope, u-form and pre-formed coil

**OFFER £645.00
SAVE £49.95
LIST PRICE £694.95**



**AVAILABLE
1ST FEB**

SP 96015000

SP Induction Heater - Coil Kit

- Contains 8 x popular sizes of interchangeable coils

**HIGHER QUALITY
COILS AT NEW
LOWER PRICE!**

£99.95



SP 90803000

**1/2" Cordless Impact Wrench
c/w 1 x 18.0v battery**

- Powerful 1/2" Impact wrench c/w 1 x 18.0v battery
- Smart design and ergonomically designed handle
- Easily controlled forward / reverse switch
- Variable speed trigger

Specification:

- Weight: 3.08kg
- Length: 240mm
- Height: 265mm
- Breakaway Torque: 982Nm
- Battery: 18v 3.0Ah
- Charging time: 45 minutes
- EU Version: 90803200



**Max Torque
982Nm**

£499.00

NEW

SP 90803100

**1/2" Cordless Impact Wrench
c/w 2 x 18.0v batteries**

- As per 90803000 (left) but includes 2 x 18.0v batteries
- EU Version: 90803300

NEW

£649.00



SP 90803500

**Replacement Battery for
1/2" Cordless Impact
Wrench**

- 18.0v Lithium Ion Battery

NEW

£150.00



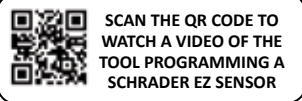

SCAN THE QR CODE TO WATCH A VIDEO OF THE TOOL PROGRAMMING A SCHRADER EZ SENSOR

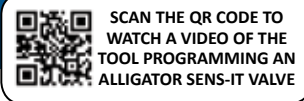

SCAN THE QR CODE TO WATCH A VIDEO OF THE TOOL PROGRAMMING AN ALLIGATOR SENS-IT VALVE

sp 306610V2

TPMS - Tyre Pressure Monitoring - Sensor Testing, Activation & Clone Valve Programming Tool

Sensor Activation - Sensor Checking - Sensor Replacement - All in One Single Tool !

- Re-programmable Clone Valve Features:
 - Able to re-program Clone valves wirelessly without using a PC or docking station
 - Fully compliant for EU frequency valves using 433Mhz & not just USA valves on 315Mhz
 - Approved for use with Schrader & Alligator EU frequency re-programmable TPMS valves
 - Step by step guidance for valve cloning
 - Able to copy old valve ID or create new ones
 - Monthly updates to add extra coverage as valve makers add new vehicle applications
 - Sensor replacement procedures
- Built-in sensor checking – no exciter tool required
- Sensor re-programming information
- Test feature allows for checking operation of sensors and sensor batteries
- Includes OEM sensor part number for reference & OEM valve component references
- Includes sensor replacement, technical and tyre rotation procedures
- Displays procedures for new sensors to be synchronised with vehicle TPMS ECU (pairing)
- Print test results / file test results & update software / applications (via PC)

£695.00



NEW MODEL
CLONE CAPABLE FOR EZ SENSOR & SENS-IT



sp 306615V2

TPMS PLUS - High Level Diagnostic TPMS Tool

All the features of the standard TPMS Tool (306610V2 - above), PLUS the following additional features:

- Connects to TPMS ECU via EOBD diagnostic lead (Containing full multiplexing functionality)
- Sensor re-programming via the EOBD socket
- Sensor & TPMS ECU fault code reading / deletion

£1295.00



TPMS Complete Kits

sp 306612V2

TPMS TOOL - Complete Kit

- Contents:
- TPMS Tool (306610V2)
 - Torque Tool Kit (80082000)

£875.00

sp 306617V2

TPMS PLUS TOOL - Complete Kit

- Contents:
- TPMS Tool (306615V2)
 - Torque Tool Kit (80082000)

£1475.00

Torque Tool Kit 80082000

- Contents:
- 3/8" Sq Dr T-Bar Handle
 - 1/4" Valve Core Tool
 - 1/4" Torx Bit T10
 - 1/4" Deep Socket - 11mm
 - 1/4" Deep Socket - 12mm
 - TPMS Grommet Tool
 - Torque Screwdriver: 0.1Nm - 3.0Nm
 - Torque Screwdriver: 2.0Nm - 10.0Nm

sp 80083000

TPMS Comprehensive + Torque Tool Kit

• Contains all the appropriate tools for servicing and replacing TPMS Valve Cores and TPMS Valve Nuts

• Contents:

- Torque Screwdriver 0.1 - 3.0Nm
- Torque Screwdriver 2.0 - 10.0Nm
- 1/4" Torx Bit T10
- 1/4" Deep Socket 11mm
- TPMS Grommet Tool
- 1/4" one way ratchet for loosening valve stem
- 3/8" sq dr T-Bar Handle (For Torque Screwdriver 2.0-10.0Nm)
- 1/4" Valve Core Tool
- 1/4" Torx Bit T20
- 1/4" Deep Socket 12mm
- T-Handle Allen Key

SUPPLIED IN FOAM FOR TOOL BOX DRAWER

£225.00





SCAN THE QR CODE TO WATCH A VIDEO OF THE SUSPENSION WORKSTATION RANGE



386800SP

Mechanical Coil Spring Compressor Workstation

Universal piece of equipment for assembling & disassembling struts and coil springs

£795.00

- Standard workstation construction but with Heavy Duty Mechanical compression components in place of pneumatic parts
- Allows for use where air supply is limited, restricted or unavailable i.e. Mobile use
- High power mechanical spindle allows for the application of up to 1600kg of compression force onto contained spring
- Long main spindle achieves large 420mm of stroke – even greater than our pneumatic workstations
- Powered by easy access 19mm hex drive on top of tool direct onto main spindle and can be used with either hand tools or even impact air tools
- Includes adjustable vice clamp as standard
- Compatible with all other Sykes-Pickavant workstation standard jaws, brackets & accessories
- Dimensions: 1400 x 520 x 300mm



UP TO 1600KG OF FORCE

Optional Accessories for use with Suspension Workstations

38480100

Mercedes Bracket Set - A, B, C & E Class

£235.00



38480200

Upper Jaw Set for High Compression Springs

£39.95



38480400

Special Bracket Porsche Cayenne / VW Touareg

£98.95



38480500

Special Bracket Mercedes C Class (2010-)

£177.95



38480600

Special Bracket Nissan Qashqai

£95.00



38480700

Double Depth Strut Vice

£115.00



PURCHASE 385800SP OR 386800SP & RECEIVE A FREE PROTECTIVE COVER

385800SP

Pneumatic Coil Spring Compressor Workstation - Extra Heavy Duty Model c/w FREE Mercedes Bracket Set

Universal piece of equipment for assembling and disassembling struts and coil springs

- Suitable for cars, 4WD's and light commercials that use McPherson strut type suspension systems
- Front and side spring clamps designed for fast changeover using unique Brackets System
- Fitted with Extra Heavy Duty Pneumatic Cylinder - Compression force (at 10 bar) = 2452 kg
- Ideal for Extra Heavy Duty applications i.e. SUV's, 4WD's etc where full spring compression is required
- Double-depth front plate for use on extra-long strut assemblies
- Safety locking valves system – locks safety cage and prevents usage with cage open

£1595.00

Includes FREE Mercedes Bracket Set (38480100) - Upper bracket for Mercedes A, B, C, E Class and Lower bracket for Mercedes E Class - WORTH £235.00



UP TO 2452KG OF FORCE (AT 10 BAR)

3858COVER

Protective Cover for 38480000, 38580000 and 38360000 Workstations

- Protective cover that fits over workstation

£36.00



sp 016795V2

Alternator Free Wheel Pulley Set - 29 Piece

- Special set of Spline & Torx Socket Bits for the removal of free-wheel alternator pulleys
- Locks the alternator, allowing the central locking bolt of the pulley to be released
- Updated 29 piece set covers a wide range of popular applications including: BMW, Citroen, Fiat, Ford, Mercedes, Opel, Peugeot, Porsche, Renault, Toyota, VW Group, Vauxhall, Volvo
- Selection of 33 tooth reaction nuts and additional adaptors

OFFER £79.95
SAVE £20.00
 LIST PRICE £99.95



sp 01370300

Universal Clutch Alignment Tool Kit

- For modern front wheel drive vehicles with or without pilot / spigot bearings with flywheel fitting diameters from 12 – 20mm
- The tools main advantage is that it includes parallel expanding supports in place of more traditional tapered fittings that are hard to keep located
- Easy to swap over adaptors suitable for clutch centre sizes from 14.4 to 29mm
- Includes small cone: 14.4 - 21mm, large cone: 20.9 - 29mm and sleeves: 12, 14, 15, 16, 17, 18, 19, 20mm

OFFER £39.95
SAVE £10.00
 LIST PRICE £49.95

sp MV5567

Mityvac Fuel Injection Cleaner System

- Quickly and cleanly removes and prevents deposits on fuel injectors as well as loosening and dissolving carbon build-up in the air induction system, including the throttle plate, intake manifold and valves
- Enhances engine performance, improves fuel economy, reduces maintenance and improves emissions
- Adjustable inlet pressure regulator for use on low and high pressure fuel systems
- Pressure gauge (0-150 PSI) (0-10 bar)
- Includes Fuel Injection Cleaner Assembly with pressure regulator, gauge, valves, fittings and 950ml canister, 1.2m long connection hose, 16 fuel injection system connectors, wall mount bracket and user manual

OFFER £399.00
SAVE £36.00
 LIST PRICE £435.00



sp 31427500

Diesel Engine Compression Test Kit - Common Rail Diesel (CRD)

- Comprehensive test kit specifically designed to cover a wide range of modern CRD diesel injected engines
- Checks engine compression under cranking conditions
- Enables cylinder access through dummy injector and glow plug adaptors
- Built-in pressure relief valve enables repeat tests without dismantling

OFFER £375.00
SAVE £20.00
 LIST PRICE £395.00

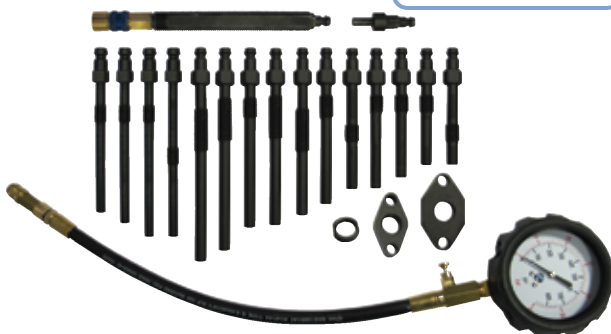

sp 08550300

GM Gearbox Bearing / Race Remover

- For the removal of taper bearing cups from clutch housings in M32, MT 20-6 and MT 32-6 manual gearboxes
- Specifically designed to spread the load equally without danger of cracking the gearbox casing
- Applications: Widely used in GM, Saab and Fiat Group



Scan the QR code to watch a video of the GM Gearbox Bearing / Race Remover

£89.95

SP 03614000

Air Assisted Caliper Piston Wind Back Tool Kit

- Air operated ram applies pressure to the caliper piston, while the handle is rotated by hand
- Easy to use – works on standard workshop air supply
- Reversible – works on both RH and LH applications
- Can be used on Wind Back and Push Back pistons
- Supplied with nine adaptors which cover a wide range of popular vehicles (applications list included)
- Also supplied with 3/8" converter to use with adaptors from manual kit (03619200)



NEW

OFFER £79.95
SAVE £20.00
LIST PRICE £99.95

SP 34201000

Manual Pressure Brake Bleeder

- Compact solution – for easy one man operation
- Portable unit – no power or air supply required
- Combination of Mityvac pressure bleeder & SP aluminium pressure bleed cap
- OE recommended pressure brake bleeding solution
- Controllable output via hand pump and pressure gauge

NEW



£199.00

SP 34300100

Automatic Brake Bleeder - 12v

- Compatible with ABS systems
- 12v powering with reverse polarity warning
- New pump with automatic power off valve
- Regulator from 0 to 3Bar
- 5L reservoir with visible level and min level indication
- Auto power OFF when min level reached
- 12V power cable with jack (L: 4m)
- Stainless steel body
- Fluid cable for brake fluid with quick coupling system (L: 4m)
- Includes fluid collection bottle and European screw-on reservoir cap
- Full range of caps available - Contact Customer Services for details



£579.00

SP 03619200

Brake Caliper Piston Windback Kit

- Recently updated kit of Piston Windback adaptors
- **Contents:**
 - RH & LH Windback tools with hex drive
 - Reaction Plate
 - 12 application adaptors for a wide range of popular models: 2000 onwards
- Additional adaptors for older applications available individually – refer to website for details

OFFER £215.00
SAVE £54.00
LIST PRICE £269.00



SP 30662000

Electronic Parking Brake (EPB) Service & Reset Tool

Coverage includes 24 vehicle manufacturers and over 120 individual models

An All-Makes Service Tool for electronically controlled Brake Service functions

- Functions include:
 - EPB: Brake Pad Replacement - CAL: Brake Pad Calibration
 - Reset: Brake Service Reset
 - Fluid Purge: ECU controlled brake fluid change
- Make & Model search facility
- Read & Clear Error Codes (EPB / ABS / ESP)
- Annual Update available for new models (£125.00)



OFFER £249.00
SAVE £246.00
LIST PRICE £495.00

SP 027296SP

Flaremaster2 Kit for 4.75 & 6mm Brake Pipes

- Hand-held flaring tool for on-the-vehicle brake pipe flaring
- Includes:
 - 02725000: Flaremaster2
 - 02160000: Pipe Aid Pliers
 - 02210000: Pipe Cutter
 - 02730000: Pipe Deburring Tool



OFFER £185.95
SAVE £57.00
LIST PRICE £242.95

FREE ELWIS H120 HEAD LIGHT TORCH & ZOOM WITH EACH 027296SP FLAREMASTER2 KIT PURCHASED





SP MV8550

Mityvac Silverline Elite Automotive Kit

- Ideal for a wide variety of workshop tasks requiring vacuum and / or pressure
- Dual convertor to switch from vacuum to pressure
- Ideal for a wide variety of diagnostic tests which require a pressure source - e.g. EVAP sensors, Cooling system leak tests etc
- Ideal for a wide variety of workshop tasks requiring vacuum and / or pressure - e.g. Diagnostics, brake bleeding, fluid transfer, evacuation, sampling etc
- **Includes:**
 - Silverline Die-Cast Aluminium Vacuum & Pressure Pump to 4bar (60psi) pressure
 - Large 480ml Fluid Reservoir with quick connection to pump
 - Selection of 12 vacuum caps
 - Diagnostic / Brake Bleeding Adaptor kit
 - Tubing and Tube Connectors

OFFER £99.95
SAVE £30.00
 LIST PRICE £129.95

SP MV5545E

Mityvac Fuel System Tester Kit

- Diagnose and pinpoint common fuel system failures including failing fuel pump, faulty pressure regulator, blocked filter(s), pinched fuel line and contaminated fuel
- Measures fuel system pressure and flow to accurately pinpoint fuel system failures
- Capable of testing both return and returnless fuel systems including electronic control
- Provides clear visualization of fuel to detect impurities and air bubbles
- **Includes:**
 - 90mm high pressure gauge with rubber boot push-button relief valve and hanging hook
 - 1.2m pressure test hose
 - In-line pressure test hose with ¼ turn valve
 - Pressure relief hose
 - User Manual
 - 37 adaptors (Available individually on request)



£995.00

SP MV7201

Mityvac Fluid Evacuator Plus

- For fluid evacuation AND dispensing
- Change from evacuation to dispensing at the press of a button
- 9ltr capacity reservoir with stabiliser base
- Automatic shut-off prevents accidental over filling
- Manual pump for mobility – no air or electric supply required
- Supplied with evacuation / dipstick tubes and adaptors
 - 1.5mtr x 5.7mm diameter
 - 1.5mtr x 6.6mm diameter
 - 1.5mtr x 10mm diameter



£140.00

SP MV6403

Mityvac Fluid Dispensing 3 in 1 Kit

- A complete package for Automotive Fluid Dispensing
- **Contains:**
 - MV6400 Fluid Dispensing System
 - MV5800 ATF Refill Adaptors Set
 - MVA804 Brake Fluid Master Cylinder Cap Adaptor



Scan the QR code to watch a video of the Mityvac Fluid Dispensing 3 in 1 Kit



£325.00



£1495.00

NEW

SP 325200SP

Portable 4 Gas Analyser
Developed from the 32420000 gas analyser

- A truly portable hand-held gas analyser
 - Ultra light weight - only 1.1Kg
- Measures CO, HC, CO2, O2 (NOx model option available on request) – to class 1 accuracy - Suitable for both Petrol and LPG vehicles
- Ideal for both static and dynamic testing - Fault diagnosis, tuning, pre-MOT testing
- Provides Lambda / AFR measurement and corrected CO
- Internal memory – stores up to 250 test results - Automatic and Manual recording options
- Pump speed control - Improves battery life
 - Up to 4 hours internal battery life
- Bluetooth connectivity to PC (additional software required)
 - Large graphic display
- Free analytical software available to download
 - Includes printer
- Includes AC & 12v chargers



SP OTC6522

LEAKTAMER™ Vapour Diagnostic Machine

Market Leading Vapour Technology - OEM Approved
Using the latest technology this new machine produces 'Vapour' rather than 'Smoke' with significant benefits for the environment and the operator

- Solve problems such as heating, ventilation & air-conditioning performance
- Helps to diagnose fault codes & MIL light problems
- OE approved UltraTrace UV® Dye locates virtually any kind of leak quickly & easily
- New flow control adjusts for specific applications, helping to pinpoint leaks quickly
- Detects Microleaks™ to and below 0.254mm

£895.00



SP PPH1

The Hook – The Ultimate Circuit Tester

All the features of a Power Probe PLUS the following:

- Activate Components
 - Watch real time current and resistance
 - Up to 100amps inrush current, 25amps constant
 - Adjustable current protection, up to 65amps
- Intermittent Circuit Testing
 - Min / Max mode for current, voltage & resistance
- Hot Shot Mode
 - Load Test Power and Grounds in only 7 milliseconds (Pass / Fail shown on screen)
- Voltage Drop
 - See Battery voltage and voltage drop on screen
- Smart Tip Technology
 - Automatically selects the Ohmmeter or Voltmeter function and selects the correct range

Examples of Applications for The Hook
Module Replacement:
Operate injectors, coils, relays, solenoids and check the current draw
Fault Code Diagnostics:
Check voltage drop and then load the circuit with power or ground – see the current, voltage and resistance immediately
Glow Plugs:
Power up glow plugs and watch current & resistance values live
Circuit Breaker:
Activate High Current devices by using The Hook as a Circuit Breaker

£399.95



Voltage Display: min / max / average



Scan the QR code to watch a video of The Hook

SP PP319FTC

Power Probe 3
Probe – Connect – Detect!

- Connect to a vehicle battery and have a multitude of testers at your fingertips!
- Power-up components
- Continuity tester
- Voltmeter
- Positive / Negative indicator
- Bad ground indicator
- Measures from 0 – 70 DC volts – in 1/10v increments



- Kit Contents:**
- Power Probe 3
 - Cigarette Lighter adaptor
 - Battery clips with heavy duty 4mm connectors
 - 20' extension lead
 - Instruction manual

£129.95

NEW

sp 60080-1

Elwis Pen Light

- LED flash light with belt clip
- Handy Magnet
- Battery included



£8.49

NEW

sp 60080

Elwis Pen Light Pack of 12

- Distributor Pack of 12 pen lights
- LED flash light with belt clip
- Handy Magnet
- Battery included



£101.80



NEW

sp 14026

Elwis "Compress Mini" COB LED Hand Lamp

- Adjustable light through 180°
- 1.5W COB LED
- 120 Lumen
- Includes belt clip, 2 x fixed magnets and 230v / USB chargers



£29.95

sp 14025

Elwis "Compress Flex" COB LED Hand Lamp

- Adjustable light through 180°
- Hanging Hook
- 3W COB LED
- 200 Lumen
- Magnetic base
- IP54 Dust Protection
- Includes 230v AC adaptor & 12v car charger



NEW



£44.95

sp 14240

Elwis "Exclusiv" COB LED Hand Lamp

- Re-chargeable 4.5W COB LED worklight
- 280 Lumen
- Rubberised ABS coating with durable PC lens
- 360 degree hanging hook
- Includes 230v AC adaptor (docking station) & 12v car charger



NEW

**OFFER £54.95
SAVE £15.00
LIST PRICE £69.95**

sp 60120

Elwis H120A Headlight Torch with Zoom – Remote Battery Pack

- Aluminium and ABS plastic construction
- 3W Cree LED
- Adjustable beam up to 80°
- Lighting distance up to 150m
- Rugged adjustable headband
- Foam padding for added comfort
- Battery compartment at rear
- Batteries included



£23.95

sp 04550000

Trim Tool Set

- Set of five strong, flexible plastic angled, lever and panel pullers
- Ideal for roof linings, door trims, panel trims and moulding strips
- Designed to enable the safe removal of vehicle trim panels without damage



**OFFER £9.95
SAVE £5.00
LIST PRICE £14.95**

NEW

sp 69002000

10 Pc. Deep Impact Socket Set - 1/2" sq dr

- Sizes: 10, 11, 13, 14, 17, 19, 21, 22, 24 and 27mm
- Supplied in metal tin



**OFFER £48.50
SAVE £10.50
LIST PRICE £59.00**

sp 01490000

Professional Circuit Tester

- 6 / 12 / 24 volts
- Robust handle with hardened steel probe
- 1.5m heavy duty insulated rubber lead
- Uses standard automotive bulb to indicate continuity



**OFFER £12.95
SAVE £7.00
LIST PRICE £19.95**

LCJKT405

Lee Cooper Polar Fleece Jacket - Black

- Polar fleece funnel neck jacket with woven panel design
- Includes elbow patches and anti-pill fabric
- Zip fastening with additional zip pockets and mobile phone pocket to chest
- 320gsm - 100% polyester

Available sizes:
M, L, XL, XXL

OFFER £24.99
SAVE £5.00
LIST PRICE £29.99



LCJKT436

Lee Cooper Quilted Jacket - Black

- 100% nylon jacket with boxed quilt effect design
- 100% polyester light weight padding
- Zip fastening to both front & hand pockets
- Fully functional chest pocket with contrast zip

Available sizes:
M, L, XL, XXL

£54.99



NEW

LC022

Lee Cooper Hi-Top Safety Boot

- Available in UK sizes: 7 - 12
- Lightweight & Flexible with modern styling
- Low profile anti-slip rubber sole
- Steel Toe Cap to ISO20345 standard
- PU Fabric Upper with textured rubber toe cap cover



£45.99

LCJKT433

Lee Cooper Padded Jacket - Black

- 100% polyester padded jacket with fixed hood
- Light weight insulation to provides an EN342 thermal grading
- Zip fastening to both front & hand pockets
- Fully functional chest pocket with contrast red zip
- Flat sleeve hem design with inner elasticated rib cuff detail
- Adjustable hem with bungee cord and toggle fastening details
- Toggle and bungee cord adjustable hood fastening

Available sizes:
M, L, XL, XXL

£54.99



NEW

AS-C4

Leather Composite Safety Boot

WATERPROOF

- Available in UK sizes: 7 - 12
- Dual Density P.U.
- Oil Resistant & Anti-Static soles
- Water Resistant Uppers
- Penetration Resistant Mid-Sole
- Non-Metallic Composite Toe Cap



£29.99

LCPNT208

Lee Cooper Cargo Trousers - Black / Grey

- Two colour trouser combining comfort & functionality
- Extending velcro fastening tool belt loop
- Triple stitched seams
- Adjustable elasticated gripper waistband
- Top loader knee pad pockets
- High abrasion resistant contrast panelling to leg hem panels
- 2 x front pockets, 2 x bellow back pockets, 2 x pleated leg pockets, Pen pocket, Phone pocket
- 65% polyester / 35% cotton double warp double weft canvas fabric

Available in waist sizes:
32", 34", 36", 38", 40", 42"

Available in leg lengths:
Short (30"), Regular (32") Long (34")

£34.99



LCKP

Lee Cooper Knee Pads for Lee Cooper Cargo / Holster Trousers

- Suitable for use with LCPNT208 trousers (right)
- Material: EVA flexible

£6.99



WORKSHOP EQUIPMENT

A NEW range of Hydraulic Workshop Presses equipped with a two-speed manual pump, overload safety valve, automatic arm back-run system and V blocks

SP THE ORIGINAL

NEW



Technical Features:

- Welded, heavy duty steel frame
- Overload safety valve
- Pressure gauge
- Winch for table (For models 53436400 & 53436500)
- Piston over-travel limit stop
- Two speed pump
- Automatic arm return
- V blocks
- Manufactured in the EU

Part No.	Style	Rating	Height	Width	Depth	Bed Depth	Range	Weight (kg)	Price
53436100	Workshop	10T	1840	850	500	145	80 - 1000	135	£525.00
53436000	Workshop	15T	1930	920	650	170	85 - 950	150	£545.00
53436200	Workshop	20T	2030	940	650	180	65 - 1030	165	£645.00
53436300	Workshop	25T	2030	950	650	180	70 - 1030	170	£865.00
53436400	Workshop	30T	2060	1120	650	200	115 - 1020	230	£985.00
53436500	Workshop	50T	2290	1220	650	210	70 - 1065	370	£1545.00

Recommended for use with Universal Press Support Block - 08770000 - See page 9 for further details

SP 36600500

Fuel Extractor / Retriever

- Retrieve fuel following a filling error, removal of tank sender unit, changing or checking the fuel gauge, rinsing the fuel tank during body work etc
- Operates from workshop compressed air (no risk of sparks)
- Mobile 45-litre tank (on wheels)
- Cleanly draws up or pushes out fuel via a venturi system
- Includes 2 anti-static ground cables, overflow line & 3 fuel probes
- Emptying via the tank filler neck or fuel lines
- Made of stainless steel

£419.00



SP 53390000

Pneumatic Oil Extractor

- Remove and extract waste fluids or oil from an engine with flexible PV tube and robust probe
- Powered from compressed air
- 70L tank capacity
- Adjustable 10L oil capture pan
- Visible fill level indicator
- 1 - 2 L/Min Suction capacity depending on nozzle used
- Working pressure 8-10 Bar
- Emptying with compressed air 1-2 bar
- CE Approved
- Includes selection of PV tubes to cater for different lengths and diameters of dipstick tubes

WARNING: Do not use with corrosive or inflammable products

£269.00



NEW

SP 38360000

Universal Gearbox Support

- Designed to support the engine or gearbox when the engine mountings have been removed - e.g. when replacing timing / drive belts, water pumps etc
- Removes the need for using cranes, transmission jacks etc
- The unit is suspended from the chassis via the support hooks, the engine / gearbox is supported by the support pad
- Fully adjustable in all dimensions:
 - Extension: Min 630mm / Max 960mm
 - Support Plate Adjustment: 190mm

£249.00

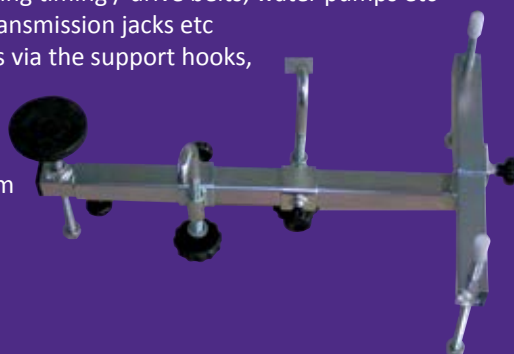

Sykes-Pickavant Ltd, Unit 4 Cannel Road, Burntwood Business Park, Burntwood, Staffs, WS7 3FU. United Kingdom
 Tel: +44 (0) 1543 679900 Fax: +44 (0) 1543 679901 e-mail: sales@sykes-pickavant.com www.sykes-pickavant.com

ALL PRICES QUOTED EXCLUDE VAT & ARE SUBJECT TO AVAILABILITY - E&OE - PRICES VALID UNTIL 31ST MARCH 2013 - REF: SPQ114GBP
 COPYRIGHT 2013 - SYKES-PICKAVANT LTD. ALL RIGHTS RESERVED.