

MAGICFX[®] CO2 DOMINATOR



PRODUCT CODE : MFX1150
 VERSION : 1.0
 DATE : 31.10.2012



1. FOREWORD

Congratulations! You have bought a great new product from MAGICFX®.

The MAGIC FX CO2 Dominator is a robust multi head CO₂ cannon designed for safely shooting CO₂. The CO2 Dominator is equipped with warning LED's to warn people around machine when armed to start the effect.. The CO2 Dominator is also equipped on board DMX512 to control the CO2 Dominator.

MAGIC FX is a Dutch manufacturer of professional special effects machines and equipment. We have been experts in special effects since our establishment in 1995. All our products are made under the brand name MAGICFX® which by now has acquired a great reputation on account of its quality and reliability. All products are made in accordance with the European Machinery Directive. MAGIC FX manages the entire production process in-house, from the design stages and prototyping to production. In short, we cover everything from concept to ready-to-use products.

Moreover, MAGIC FX is Europe's largest supplier of high-quality and fireproof confetti products and streamers. Thanks to our very large stock levels, we can deliver quickly and at low prices.

MAGICFX® is used by special effects professionals all over the world and our products are distributed through a dealer network which covers more than 90 countries.





Congratulations and enjoy your purchase!

This manual describes the MAGICFX® CO2 Dominator. The information in this manual is important for the proper and safe functioning of the CO2 Dominator. If you are not familiar with the installation, operation, preventative maintenance etc. of the CO2 Dominator then please read this user manual carefully from beginning to end. MAGIC FX also insists that all new users (operators, installers, maintenance workers and cleaners) receive a training course in which this user manual can serve as a starting point.

MAGIC FX advises that the original of this user manual, including appendices, is kept at a safe and central place. It is best that another original or copy is kept close to the CO2 Dominator at the workplace.

If you are familiar with these matters, then you can use this manual as a work of reference.

The following standard markings are used in this manual for drawing attention to certain subjects or actions.

	<p>TIP: Gives you suggestions and advice regarding easier or more convenient ways to carry out certain tasks.</p>
	<p>PLEASE NOTE: A comment with additional information: alerts you to certain problems.</p>
	<p>CAUTION: The machine can be damaged if you do not follow the procedures carefully.</p>
	<p>DANGER WARNING: You can get (seriously) hurt if you do not carefully carry out the procedures.</p>

CONTENTS

1.	FOREWORD	1
2.	INTRODUCTION	3
2.1	DESCRIPTION AND APPLICATION OF THE CO2 DOMINATOR.....	3
2.2	NECESSARY ACCESSORIES.....	3
3.	SAFETY	4
3.1	INTRODUCTION	4
3.2	GENERAL SAFETY RULES.....	4
3.3	WARNINGS.....	4
4.	PARTS	6
5.	ACCESSOIRES.....	7
6.	PREPARATIONS	7
7.	INSTALLATION	8
8.	USAGE.....	13
9.	SWITCHING OFF	14
10.	CE MARKING.....	15
11.	DECLARATION OF CONFORMITY.....	16
12.	TROUBLESHOOTING	17
13.	NOTES	18
14.	TECHNICAL SPECIFICATIONS.....	19
15.	MAINTENANCE	19
16.	GUARANTEE	19

2. INTRODUCTION

2.1 DESCRIPTION AND APPLICATION OF THE CO2 DOMINATOR

The CO2 Dominator is intended to electronically blow white smoke plumes of CO₂ from a distance. As soon as the CO₂ leaves the cylinder through the CO2 Dominator's secured high-pressure hoses, it converts into gas. This formation of gas is accompanied by a strong hissing sound and a solid white plume of smoke will be visible. The length of this plume is on average 8 metres. This depends on the air humidity: in case of a high degree of air humidity, the smoke plume will be larger and in case of a low degree of air humidity it will be smaller.

The CO2 Dominator must be connected to a carbon dioxide (CO₂) cylinder with dip pipe.

Any use other than that described above excludes your supplier from any liability.

The CO2 Dominator has been designed and constructed in such a manner that it can be used safely. This applies to the application, the circumstances and the regulations as described in this documentation. Reading this documentation and the following instructions are therefore necessary for everyone who is authorised to work with the CO2 Dominator.



2.2 NECESSARY ACCESSORIES

De volgende onderdelen horen bij de CO2 Dominator:

<p>Manual</p>	<p>MFX0308 – Power cable</p>	<p>4x CO2 Cylinders (with dip pipe)</p>
<p>High pressure hose 3/4</p>	<p>MFX1154 – Distribution block</p>	<p>4x High pressure hose 3/8</p>

Table 2.1

3. SAFETY

3.1 INTRODUCTION

The CO2 Dominator has been designed and constructed in such a manner that it can be used safely. This applies to the use, the circumstances and the regulations as described in this documentation. Reading this documentation and following the instructions are therefore necessary for everyone who is authorised to work with the CO2 Dominator.

The CO2 Dominator must be placed and used in surroundings that preferably:

- Have a reasonably stable temperature of between 0 and 30°C.
- Have a relative humidity degree of no more than 75%.
- Are reasonably free of dust, corrosive gases and high concentrations of organic vapours.
- Are not situated in the vicinity of a source of vibration.

3.2 GENERAL SAFETY RULES



- Ensure that children, unauthorised persons and animals cannot obtain access to the CO2 Dominator!
- Safety devices may not be removed or disabled.
- All required safety devices must be in good condition and function properly.
- Ensure sufficient lighting of the surroundings.
- Keep the workplace clean.
- Only authorised persons may carry out work with the CO2 Dominator.



3.3 WARNINGS



Warning texts have been attached to the CO2 Dominator. With regard to these the following rules apply:

- These texts may not be removed or damaged. The operator must regularly check if this is the case.
- The operator must ensure that the texts are and remain clearly visible and legible.

	<p>DANGER WARNING: One must replace texts or signs if these are absent, damaged or illegible.</p>
---	--

Sign and explanation	Photo
 <p>PIC 616 Follow the instructions</p>	
<p>The operator must be told that he/she may only operate the CO2 Dominator after reading the user manual.</p> <p>A warning is given for this by means of the command sign of PIC 616. This sign should be attached to the type sign. See also the photo.</p>	

Sign and explanation	Photo
<div style="text-align: center;">  <p>PIC 307 High voltage</p> </div>	
<p>A warning must be given about the machine's high voltage by using the caution sign PIC 307. This sign must be attached to the CO2 Dominator. See also the added photo.</p>	

Sign and explanation	Photo
<div style="text-align: center;">  <p>PIC 323 Low temperatures</p> </div>	
<p>In case of low temperatures a low temperature warning must be issued by means of warning sign 323.</p> <p>This is attached to the top of the CO2 Dominator.</p>	

4. PARTS

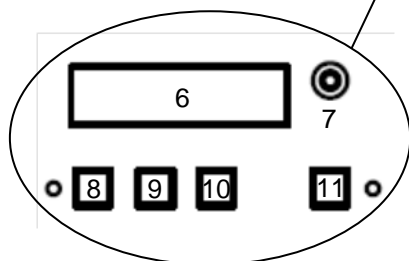
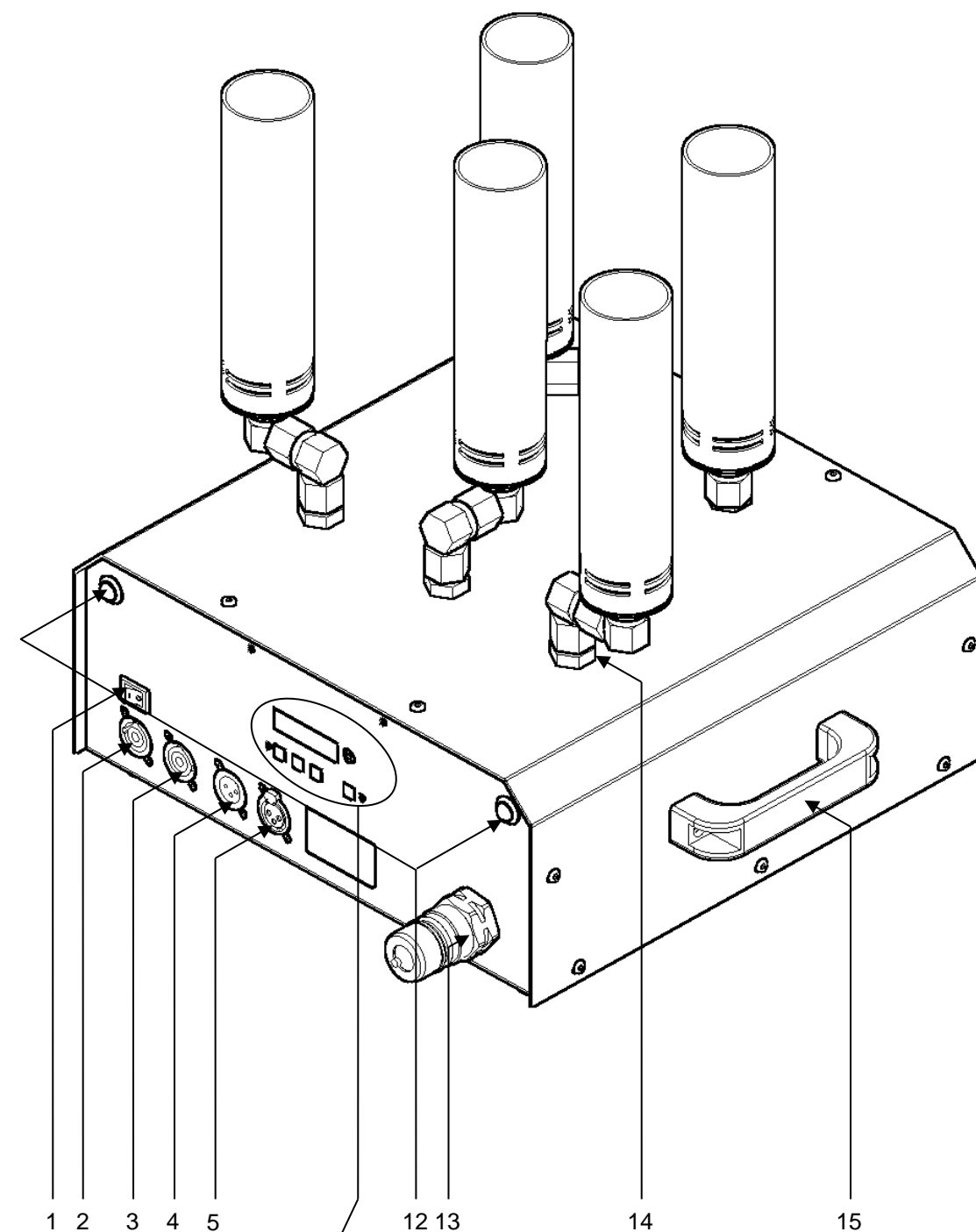

- | | |
|-----------------|-------------------|
| 1. Power Switch | 9. UP button |
| 2. Power input | 10. DOWN button |
| 3. Power output | 11. RESET button |
| 4. DMX input | 12. Warning LED's |
| 5. DMX output | 13. CO2 input |
| 6. Display | 14. CO2 output |
| 7. DMX LED | 15. handle |
| 8. MENU button | |

5. ACCESSOIRES

			
MFX0308 – Shuko – powerCON cable 1.5m	MFX1154 – Distribution Block	MFX3101 – Twenty clamp M10	
			
MFX1151 – High pressure hose 3/4 - 6m	MFX1152 – High pressure hose 3/4 - 10m	MFX1153 – High pressure hose 3/4 - 15m	
			
MFX1103 – High pressure hose 3/8 - 3m	MFX1106 – High pressure hose 3/8 - 6m	MFX1110 – High pressure hose 3/8 - 10m	MFX1115 – High pressure hose 3/8 - 15m

Table 5.1

You can order these parts and accessories from:



MAGIC FX B.V.
Schouwrooij 27
NL-5281 RE BOXTEL
The Netherlands
T. +31(0)411 63 50 13
F. +31(0)411 63 50 12
W. <http://www.magicfx.eu>
E. info@magicfx.eu



6. PREPARATIONS

Unpack the CO2 Dominator. Dispose of the packaging material without harming the environment. Inspect the machine for any damage. If damage is noticed this must be reported to MAGIC FX.

7. INSTALLATION

	<p>CAUTION: The machine can be damaged if you do not follow the procedures carefully.</p>
	<p>DANGER WARNING: The MAGICFX® CO2 Dominator may only be installed by adults and authorised persons.</p>
	<p>DANGER WARNING: MAGIC FX is not liable for working with CO2 gas and CO2 bottles or for the correct use thereof.</p> <p>Exclusively use approved CO2 bottles (liquid carbon dioxide with dip pipe) and consult your gas supplier about the installation, instructions, guidelines and regulations for the safe use of the CO2 bottles.</p>

For installing the CO2 Dominator work in the following manner:

1.



Place the CO2 Dominator on a stable and even surface



Make sure that there is always a space of 3 metres around the CO2 Dominator which is free of people.

2.



Check if the on/off switch is in the 'off' position and then connect the power cable. The CO2 Dominator runs on 230V~50/60Hz.

You will need a powerCON plug to provide the CO2 Dominator with power. The CO2 Dominator is also equipped with a powerCON 'loop cable' connector.

By using a powerCON loop cable you can connect several CO2 Dominators to the same energy source.

3.



Connect a 3-pin DMX cable to the CO2 Dominator.

You can connect several CO2 Dominators to each other by using 3-pin DMX cables.

Connect the other end of the DMX cable (male plug) to a professional DMX controller.



Always make sure that the controller is placed in such a way that the operator has a clear view of all the connected CO2 Dominators.



Consult the manual of your DMX controller for instructions and the safe use of it.

4.



Now connect the CO2 high pressure hoses of 2 metres length to the CO2 cylinders.

Turn the couplings firmly by hand.



Turning it by hand will suffice! You should only use a wrench if the coupling continues to leak.

5.



Place the CO2 cylinders (liquid carbon dioxide with dip pipe) on an even and solid surface. Place the cylinders in such a position so that the opening of the valve does not point in the direction of people or objects. Preferably place the CO2 cylinders outdoors or in a space provided with good ventilation and a CO2 detection system. CO2 cylinders are pressure containers. Therefore secure them with special gas bottle brackets or a chain to prevent them from toppling over.

6.

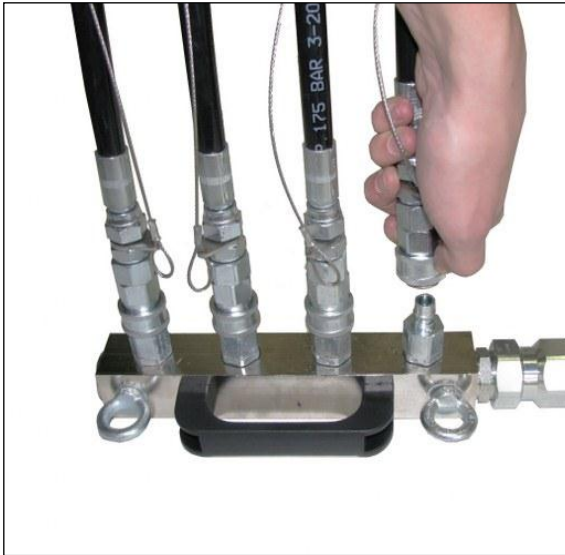

Connect the other ends of the CO2 high pressure hoses to the manifold block and check that these are properly connected.

7.

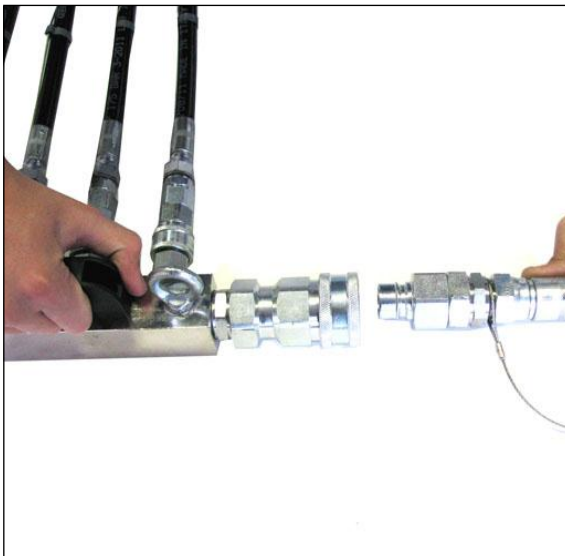

Now connect the 3/4" CO2 high pressure hose to the manifold block and check if it is firmly connected.

8.



Connect the other end of the 3/4" CO2 high pressure hose to the socket at the back of the CO2 Dominator.

Again check if it is firmly connected.

9.



Turn on the machine by pushing the switch of the CO2 Dominator in the 'on' position.

10.



After the CO2 Dominator has been fully connected the CO2 Dominator can be installed.



During installation, make sure that you use free channels on the DMX controller and that these channels are in the safe mode. The safe mode means that during the installation of the CO2 Dominator the 0-values of a channel are set. Consult the manual of the DMX controller for the set-up.

Push the 'MODE' button to start the set-up of the CO2 Dominator.

11.

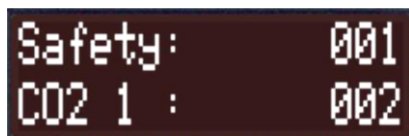

The display will now change to the screen pictured on the left.

You will see the address behind Safety flash on and off. This is the address which can be used for releasing the machine.

Change to the required address by pushing the ▲ or ▼ button. Then push the MODE button to confirm your choice.



When you use several machines it is advisable to use the same 'Safety' channel for each CO2 Dominator.

1
2.



You will see the address behind CO₂ 1 flash on and off. This is the address with which a series of 5 CO₂ addresses starts.

Change to the required address by pressing the ▲ or ▼ button. Then press the MODE button to confirm your choice.



The other outputs will automatically be consecutive. For example: you set channel 2 as 1st output of the CO₂ Dominator. The 2nd output will be channel 3, the 3rd output channel 4 etc.

1
3.



Open the valves of the gas bottles.

8. USAGE

	<p>TIP: Gives you suggestions and advice regarding easier or more convenient ways to carry out certain tasks.</p>
	<p>CAUTION: The machine can be damaged, if you do not follow these procedures carefully.</p>
	<p>DANGER WARNING: The MAGICFX® CO2 Dominator may only be installed by adults and authorised persons.</p> <p>The CO2 Dominator may only be operated if all parts are completely and correctly installed/connected.</p>

For using the CO2 Dominator take the following steps:

1.



After the set-up of the CO2 Dominator and the correct addresses you are ready to use the machine.

To get the CO2 Dominator out of the safe mode, the 'safety' channel on the CO2 Dominator must be set between 40% and 60%.

The LED light on the back of the CO2 Dominator now starts to flash on and off.

2.



To activate the CO2 Dominator and to have a CO2 smoke plume blow from the machine, you press the flash button of the 'fire' channel on the DMX controller.



Before starting to blow CO2 always make sure that nobody is present within the zone of the CO2 Dominator. Additionally, always ensure you have a clear vision of the CO2 Dominator during the effect. For the correct use of the DMX controller you can consult the manual of the machine.

9. SWITCHING OFF

To switch off the CO2 Dominator, take the following steps:

1.



Close the valve of the gas bottle.

2.



Activate the CO2 Dominator one more time to remove the remaining pressure from the hose.

3.

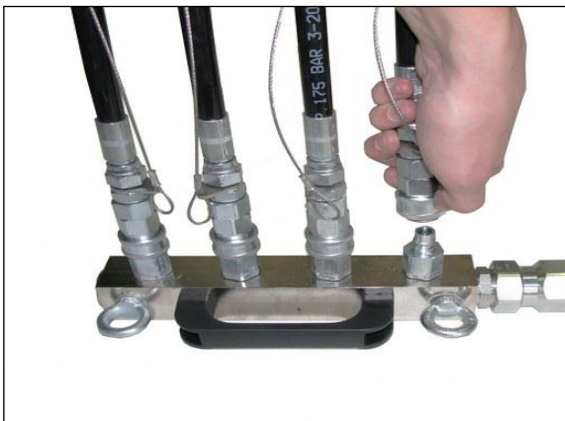



Only once there is no more gas in the hose it can be disconnected from the CO2 Dominator and the manifold block.

4.



Disconnect the plug(s) of the CO2 Dominator from the energy supply.

10. CE MARKING

	<p>PLEASE NOTE: We presume that you, your employees and others who use or come into contact with the machine are familiar with how the machine must be dealt with. This includes the correct use, maintenance and repair of the machine as described in this user manual. This also means that the employees are familiar with the use of machines through training or experience.</p>
	<p>DANGER WARNING: Only use the CO2 Dominator in accordance with the regulations and instructions in this manual. Consult MAGIC FX in case of doubt.</p>

Disclaimers:

MAGIC FX B.V. excludes liability for unsafe situations, accidents and damage that are the result of:

- Disregard for the warnings or regulations as set out on the CO2 Dominator or in this documentation.
- Use for other purposes or under other circumstances than those set out in this documentation.
- Alterations to the CO2 Dominator. This also includes the use of replacement parts other than the original ones.
- Insufficient maintenance.
- Unauthorised removal of safety caps and/or safeguards.
- Incompetent operation of the machine.

MAGIC FX B.V. is not liable for any consequential loss in the event of a CO2 Dominator breakdown.

© Copyright 2012

All rights are reserved. Nothing from this manual may be duplicated, or kept in an automated data file, or made public, or in any form or manner, whether electronically, mechanically, by photocopying, by incorporation, or in any other manner duplicated without the permission of MAGIC FX B.V.

MAGIC FX at all times retains the right to make alterations without the direct knowledge of the client. The contents of this user manual can also be changed.

Please contact the technical department of your supplier for extra information with regard to, for example, maintenance and repair. This user manual has been drawn up with the utmost care. MAGIC FX cannot be held responsible for any mistakes made in this publication or for any consequences thereof.

11. DECLARATION OF CONFORMITY

DECLARATION OF CONFORMITY
(according to Annex II.1.A of the Machinery Directive)



Concerning the Machinery Directive.

We; MAGIC FX B.V.

Schouwrooij 27

5281 RE Boxtel

The Netherlands

State under personal responsibility:

We are the manufacturer of the product:

MFX1150 - MAGICFX® CO2 Dominator

to which this statement relates and which is in accordance with the provisions of the following Directive(s):

- Machinery Directive 2006/42/EC
- Low Voltage Directive 2006/95/EC
- EMC Directive 2004/108/EG
- Pressure Equipment Directive 97/23/EC

The following harmonising standards have been applied:

- NEN-EN-ISO 12100
- NEN-EN-IEC 60204-1

Place : Boxtel

Date : 18-10-2012

Name: MAGIC FX

A handwritten signature in black ink, appearing to be 'B. Veroude', is written over a horizontal line. The signature is stylized and includes a large circular flourish on the left side.

Director: B. Veroude

12. TROUBLESHOOTING

- **The CO2 Dominator is leaking**

Check if the coupling of the gas hose is connected properly to the coupling of the CO2 Dominator. If it is not entirely secured then press it firmly. This is only possible when there is no pressure on the hose. If the problem persists, then consult the technical service of MAGIC FX.

- **Only a small smoke plume is visible when the CO2 gas exits the CO2 Dominator.**

Visibility can vary due to air humidity. The output will be more visible when there is high absolute air humidity.

- **There is no white smoke plume visible when the CO2 gas exits the CO2 Dominator.**

You may not have the right carbon dioxide cylinders. Connect bottles with liquid carbon dioxide and a dip pipe to the CO2 Dominator.

In some cases the dip pipe may be broken. In that case replace the carbon dioxide bottle with another and inform your gas supplier about the cylinder with the defective dip pipe.

- **An output stays open after shooting.**

Check if there are 4 CO₂ cylinders connected to the CO2 Distribution Block and if the cylinders are opened and full. If not, replace or connect the empty or missing CO₂ cylinders.

- **The CO2 Dominator is still malfunctioning after troubleshooting**

Always contact your dealer or the technical service of MAGIC FX first in case of uncertainties, questions about the CO2 Dominator works or other issues with regard to the CO2 Dominator.

14. TECHNICAL SPECIFICATIONS

Measurements and weight	Length:	350mm (13.8")
	Width:	350mm (13.8")
	Height:	150mm (5.9")
	Weight:	18 Kg (39.7lbs.)
Power	Input:	AC 230V~50-60Hz
	Usage:	125W
	Fuse:	5A 250V 5x20mm
DMX	Input:	3 pin Neutrik XLR Male Socket
	Output:	3 pin Neutrik XLR Female Socket
CO ₂	Input:	Liquid CO ₂
	Output:	CO ₂ Gas
	Usage:	0,5 Kg/s (1.1 lbs/s) per output
	Quick Connector:	RU 1 (W21,8x1/14") – 3/8" BSP

Design and product specifications can be changed without prior notification.

15. MAINTENANCE

To achieve the maximum service life of the CO2 Dominator you must regularly clean the CO2 Dominator and test if it is working correctly.

Should the CO2 Dominator not work for some reason then please contact MAGIC FX.

	<p>DANGER WARNING: Do not replace parts yourself; always consult MAGIC FX if necessary.</p>
--	--

16. GUARANTEE

A manufacturer's guarantee of 3 years applies to the MAGIC FX CO2 Dominator.

- The guarantee expires if the CO2 Dominator is used for improper purposes and for applications which are not stated in this manual.
- The guarantee also expires if the machine is used incorrectly or in violation of the regulations.
- The guarantee expires if the machine is altered without permission from the supplier.