

F3X33 Series User Manual	Documentation No.	Product Version	Page
	Product Name:		Total:

F3X33 Series User Manual

The user manual is suitable for the following model:

Model	Product Type
F3133	GPRS ROUTER
F3233	CDMA ROUTER
F3333	EDGE ROUTER
F3433	WCDMA ROUTER
F3533	TD-SCDMA ROUTER
F3633	EVDO ROUTER



[Xiamen Four-Faith Communication Technology Co., Ltd.](#)

Add: J1-J3,3rd Floor,No.44,GuanRi Road,SoftWare

Park,XiaMen,China Zip Code:361008

Tel: +86 592-6300326 , 6300325, 6300324

Fax:+86 592-5912735

<http://www.fourfaith.com>





Files Revised Record

Date	Version	Remark	Author

Copyright Notice

All contents in the files are protected by copyright law, and all copyrights are reserved by Xiamen Four-Faith Communication Technology Co., Ltd. Without written permission, all commercial use of the files from Four-Faith are forbidden, such as copy, distribute, reproduce the files, etc., but non-commercial purpose, downloaded or printed by individual (all files shall be not revised, and the copyright and other proprietorship notice shall be reserved) are welcome.

Trademark Notice

Four-Faith、四信、、、、 are all registered trademarks of Xiamen Four-Faith Communication Technology Co., Ltd., illegal use of the name of Four-Faith, trademarks and other marks of Four-Faith is forbidden, unless written permission is authorized in advance.



Contents

Chapter 1 Brief Introduction of Product	6
1.1 General	6
1.2 Features and Benefits	6
1.3 Working Principle	7
1.4 Specifications	7
Chapter 2 Installation Introduction	11
2.1 General	11
2.2 Encasement List	11
2.3 Installation and Cable Connection	11
2.4 Power	13
2.5 Indicator Lights Introduction	13
2.6 Reset Button Introduction	14
Chapter 3 Configuration and Management	15
3.1 Configuration Connection	15
3.2 Access the Configuration Web Page	15
3.3 Configuration	16
3.3.1 Welcome	16
3.3.2 WAN Settings	16
3.3.3 WIFI Settings	18
3.3.4 LAN Settings	21
3.3.5 NAT	21
3.3.6 DMZ	23
3.3.7 Filter	23
3.3.8 Static Routes	26
3.3.9 Router Status	27
3.3.10 Backup Settings	28
3.3.11 Load Default	29
3.3.12 Router Upgrade	29
3.3.13 Set Password	30
3.3.14 Logs	30
3.3.15 Misc	33
3.3.16 PPTP Client	33
3.3.17 L2TP Client	34
3.3.18 IPSEC Client	35
3.3.19 Dynamic DNS	35
3.3.20 Serial Settings	37
Chapter 4 Appendix	39

Chapter 1 Brief Introduction of Product

1.1 General

F3X33 series ROUTER is a kind of cellular terminal device that provides data transfer function by public cellular network.

It adopts high-powered industrial 32-bits CPU and embedded real time operating system. It supports RS232 (or RS485/RS422), Ethernet and WIFI port that can conveniently and transparently connect one device to a cellular network, allowing you to connect to your existing serial, Ethernet and WIFI devices with only basic configuration.

It has been widely used on M2M fields, such as intelligent transportation, smart grid, industrial automation, telemetry, finance, POS, water supply, environment protection, post, weather, and so on.

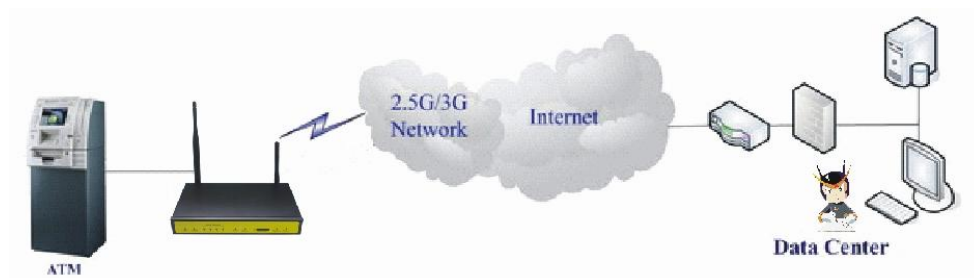

1.2 Features and Benefits

Design for Industrial Application

- ◆ High-powered industrial cellular module
- ◆ High-powered industrial 32bits CPU
- ◆ Support low-consumption mode, including sleep mode, scheduled online/offline mode, scheduled power-on/power-off mode(optional)
- ◆ Housing: iron, providing IP30 protection.
- ◆ Power range: DC 5~35V

Stability and Reliability

- ◆ Support hardware and software WDT
- ◆ Support auto recovery mechanism, including online detect, auto redial when offline to make router always online
- ◆ Ethernet port: 1.5KV magnetic isolation protection
- ◆ RS232/RS485/RS422 port: 15KV ESD protection
- ◆ SIM/UIM port: 15KV ESD protection
- ◆ Power port: reverse-voltage and overvoltage protection
- ◆ Antenna port: lightning protection(optional)

[Xiamen Four-Faith Communication Technology Co.,Ltd.](http://www.fourfaith.com)

Page 6 of 40

Add: J1-J3,3rdFloor,No.44,GuanRiRoad,SoftWare Park,XiaMen .361008.China

http: //www.fourfaith.com Tel: +86 592-6300326 6300325 6300324 Fax: +86 592-5912735

Standard and Convenience

- ◆ Support standard RS232(or RS485/RS422), Ethernet and WIFI port that can connect to serial, Ethernet and WIFI devices directly
- ◆ Support standard WAN port and PPPOE protocol that can connect to ADSL directly
- ◆ Support intellectual mode, enter into communication state automatically when powered
- ◆ Provide management software for remote management
- ◆ Support several work modes
- ◆ Convenient configuration and maintenance interface (WEB or CLI)

High-performance

- ◆ Support double link backup between cellular and WAN(PPPOE, ADSL) (optional)
- ◆ Support VPN client(PPTP, L2TP, IPSEC and GRE)(only for VPN version)
- ◆ Support port mirror function(optional)
- ◆ Support WIFI AP, WIFI AP client and WDS(optional)
- ◆ Support multi online trigger ways, including SMS, ring and data. Support link disconnection when timeout
- ◆ Support APN/VPDN
- ◆ Support wireless video monitoring and dynamic picture transfer
- ◆ Support DHCP server and client, DDNS, firewall, NAT, DMZ host etc.
- ◆ Support multi protocols, such as TCP/IP, UDP, ICMP, SMTP, HTTP, POP3, OICQ, TELNET, FTP, SNMP, etc.

1.3 Working Principle

The principle chart of the router is as following:

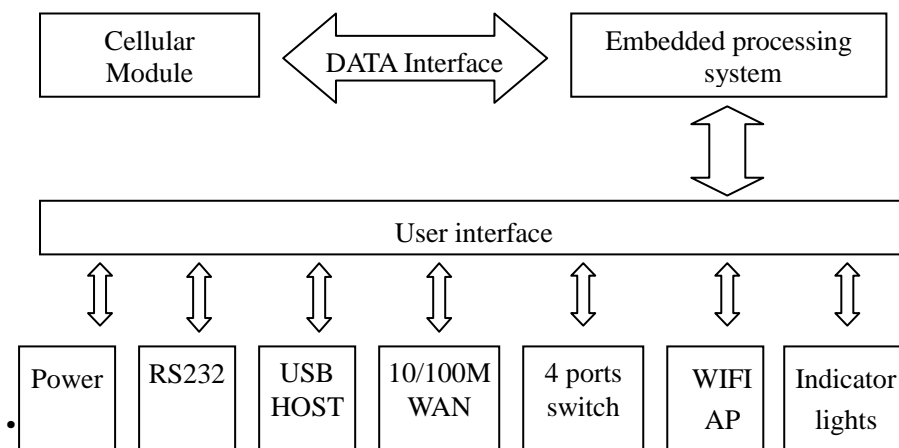

1.4 Specifications

Cellular Specification

Standard and Band	Bandwidth	TX power	RX sensitivity
F3133 GPRS ROUTER			
EGSM900/GSM1800MHz, GSM850/900/1800/1900MHz (optional) Compliant to GSM phase 2/2+ GPRS class 10, class 12(optional)	85.6Kbps	GSM850/900: <33dBm GSM1800/1900: <30dBm	<-107 dBm
F3233 CDMA ROUTER			
CDMA2000 1xRTT 800MHz 800/1900MHz(optional) 450MHz(optional)	153.6Kbps	<30dBm	<-104 dBm
F3333 EDGE ROUTER			
GSM850/900/1800/1900MHz GPRS/EDGE Class 12	236.8Kbps	GSM850/900: <33dBm GSM1800/1900: <30dBm	<-106 dBm
F3433 WCDMA&HSDPA&HSUPA ROUTER			
UMTS/WCDMA/HSDPA/HSUPA 850/1900/2100MHz 850/900/1900/2100MHz(optional) GSM850/900/1800/1900MHz GPRS/EDGE CLASS 12	HSUPA:5.76Mbps (Upload speed) HSDPA:7.2Mbps (Download speed) UMTS:384Kbps (DL/UL)	<24dBm	<-109 dBm
F3533 TD-SCDMA ROUTER			
TD-SCDMA/HSDPA/HSUPA 1880-1920/2010-2025MHz GSM850/900/1800/1900MHz GPRS/EDGE CLASS 12	Download speed:2.8Mbps upload speed:2.2Mbps	<24dBm	<-108 dBm
F3633 CDMA2000 1X EVDO			
CDMA2000 1X EVDO Rev A 800MHz,800/1900MHz(optional) 450MHz (optional) CDMA2000 1X RTT, IS-95 A/B	Download speed:3.1Mbps upload speed:1.8Mbps	<23dBm	<-104 dBm

WIFI Specification

Item	Content
Standard	IEEE802.11b/g IEEE802.11n (optional)

Bandwidth	IEEE802.11b/g: 54Mbps (max) IEEE802.11n: 300Mbps (max)
Security	WEP, WPA, WPA2, etc. WPS (optional)
TX power	16-17dBm(11g), 18-20dBm(11b)
RX sensitivity	<-72dBm@54Mbps

Hardware System

Item	Content
CPU	Industrial 32bits CPU
FLASH	4MB(Extendable to 16MB)
SDRAM	32MB(Extendable to 64MB)

Interface Type

Item	Content
WAN	1 10/100 Mbps WAN port(RJ45), auto MDI/MDIX, 1.5KV magnetic isolation protection
LAN	4 10/100 Mbps Ethernet ports(RJ45), auto MDI/MDIX, 1.5KV magnetic isolation protection
Serial	1 RS232(or RS485/RS422) port, 15KV ESD protection Data bits: 5, 6, 7, 8 Stop bits: 1, 1.5, 2 Parity: none, even, odd, space, mark Baud rate: 110~230400 bps
Indicator	"Power", "System", "Online", "Alarm", "Local Network", "WAN", "WLAN"
Antenna	Cellular: Standard SMA female interface, 50 ohm, lightning protection(optional) WIFI: Standard SMA male interface, 50 ohm, lightning protection(optional)
SIM/UIM	Standard 3V/1.8V user card interface, 15KV ESD protection
Power	Standard 3-PIN power jack, reverse-voltage and overvoltage protection
Reset	Restore the router to its original factory default settings
USB	Standard A type USB host interface (reserved)



Power Input

[Xiamen Four-Faith Communication Technology Co.,Ltd.](http://www.fourfaith.com)

Page 9 of 40

Add: J1-J3, 3rd Floor, No.44, GuanRi Road, Software Park, Xiamen .361008.China

http: //www.fourfaith.com Tel: +86 592-6300326 6300325 6300324 Fax: +86 592-5912735

Item	Content
Standard Power	DC 12V/1.5A
Power Range	DC 5~35V
Consumption	<450mA (12V)

Physical Characteristics

Item	Content
Housing	Iron, providing IP30 protection
Dimensions	206x135x28 mm
Weight	790g

Environmental Limits

Item	Content
Operating Temperature	-25~+65 ℃ (-13~+149°F)
Extended Operating Temperature	-30~+75 ℃ (-22~+167°F)
Storage Temperature	-40~+85 ℃ (-40~+185°F)
Operating Humidity	95% (Non-condensing)

Chapter 2 Installation Introduction

2.1 General

The router must be installed correctly to make it work properly.

Warning: Forbid to install the router when powered!

2.2 Encasement List

Name	Quantity	Remark
Router host	1	
Cellular antenna (Male SMA)	1	
WIFI antenna (Female SMA)	1	
Network cable	1	
Console cable	1	optional
Power adapter	1	
Manual CD	1	
Certification card	1	
Maintenance card	1	

2.3 Installation and Cable Connection

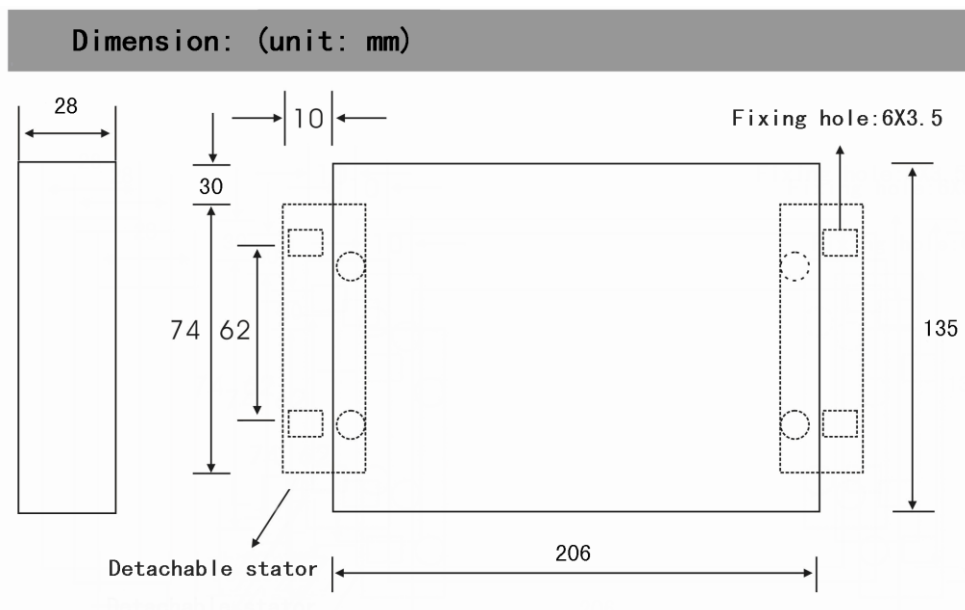

Installation of SIM/UIM card:

Firstly power off the router, and press the out button of the SIM/UIM card outlet with a needle object. Then the SIM/UIM card sheath will flick out at once. Put SIM/UIM card into the card sheath (Pay attention to put the side which has metal point outside), and insert card sheath back to the SIM/UIM card outlet.

Warning: Forbid to install SIM/UIM card when powered!

Installation of antenna:

Screw the SMA male pin of the cellular antenna to the female SMA interface of the router with sign “WWAN”.

Screw the SMA female pin of the WIFI antenna to the male SMA interface of the router with sign “WIFI”.

Warning: The cellular antenna and the WIFI antenna can not be connected wrongly. And the antennas must be screwed tightly, or the signal quality of antenna will be influenced!

Installation of cable:

Insert one end of the network cable into the switch interface with sign “Local Network”, and insert the other end into the Ethernet interface of user’s device. The signal connection of network direct cable is as follows:

RJ45-1	RJ45-2
1	1
2	2
3	3
4	4
5	5
6	6
7	7
8	8

Insert the RJ45 end of the console cable into the RJ45 outlet with sign “console”, and insert the DB9F end of the console cable into the RS232 serial interface of user’s device.

The signal connection of the console cable is as follows:

RJ45	DB9F
1	8
2	6
3	2
4	1
5	5
6	3
7	4
8	7

The signal definition of the DB9F serial communication interface is as follows:

Pin	RS232 signal name	The direction for Router
1	DCD	output
2	RXD	output
3	TXD	input
4	DTR	input
5	GND	
6	DSR	output
7	RTS	input
8	CTS	output

2.4 Power

The power range of the router is DC 5~35V.

Warning: When we use other power, we should make sure that the power can supply power above 7W.

We recommend user to use the standard DC 12V/1.5A power.

2.5 Indicator Lights Introduction

The router provides following indicator lights: “Power”, “System”, “Online”, “Alarm”, “Local Network”, “WAN”, “WLAN”.

Indicator Light	State	Introduction
Power	ON	Router is powered on
	OFF	Router is powered off
System	BLINK	System works properly
	OFF	System does not work
Online	ON	Router has logged on network
	OFF	Router hasn't logged on network
Alarm	ON	SIM/UIM card does not work or the signal of the antenna is weak
	OFF	Router has no alarm
Local Network	OFF	The corresponding interface of switch is not connected
	ON / BLINK	The corresponding interface of switch is connected /Communicating
WAN	OFF	The interface of WAN is not connected

	ON / BLINK	The interface of WAN is connected /Communicating
WLAN	OFF	WLAN is not active
	ON	WLAN is active

2.6 Reset Button Introduction

The router has a “Reset” button to restore it to its original factory default settings. When user press the “Reset” button for up to 15s, the router will restore to its original factory default settings and restart automatically.

Chapter 3 Configuration and Management

This chapter describes how to configure and manage the router.

3.1 Configuration Connection

Before configuration, you should connect the router and your configuration PC with the supplied network cable. Plug the cable's one end into the Local Network port of the router, and another end into your configure PC's Ethernet port. The connection diagram is as following:

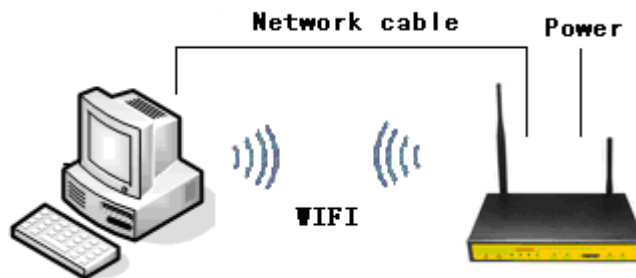

Please modify the IP address of PC as the same network segment address of the router, for instance, 192.168.1.9. Modify the mask code of PC as 255.255.255.0 and set the default gateway of PC as the router's IP address (192.168.1.1).

3.2 Access the Configuration Web Page

Start a web browser and type 192.168.1.1 in the Address (URL) field (The Default IP Address of the Ethernet port is 192.168.1.1). It will prompt a login page. The default username and password are both "admin". Please input the username and password login to access the configuration pages.

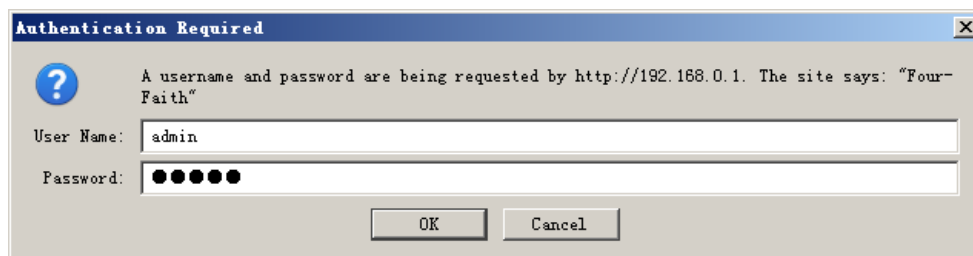

3.3 Configuration

3.3.1 Welcome

The “Welcome” page will give some contact information, if you have any question or problem, please contact us.

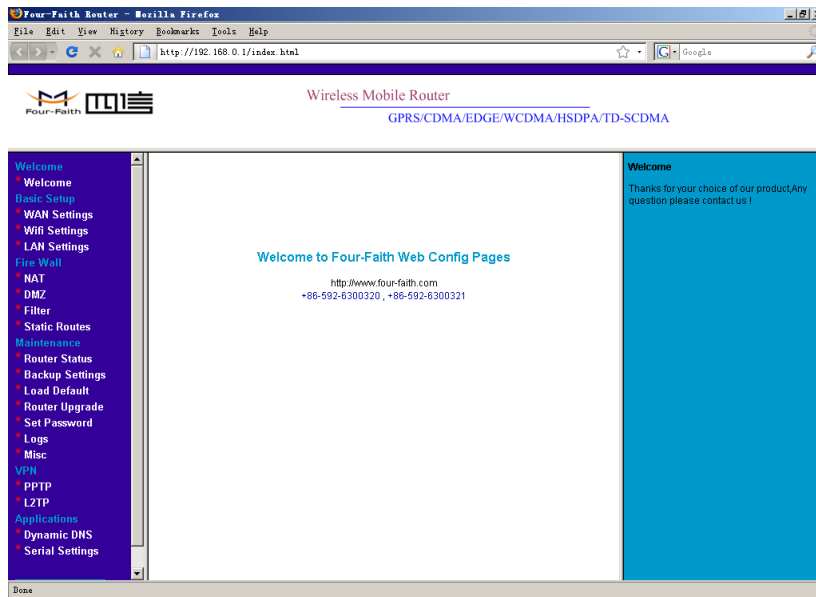

3.3.2 WAN Settings

This page is used to configure the Internet access parameters.

WAN Wireless

WAN Wireless

UserName	<input type="text"/>
Password	<input type="password"/>
Call Center	<input type="text" value="*99***1#"/>
APN	<input type="text" value="●●●●●"/>

Note:

Model	APN	Username and password	Call center
F3133	Cmnet Uninet	null	*99***1#

F3233	null	card	#777
F3333	cmnet	null	*99***1#
F3433	3gnet	null	*99#
F3533	cmnet	null	*98*1#
F3633	null	card	#777

UserName: username used to login your ISP(Internet Service Provider)

Password: password used to login your ISP

Call Center: The dial number of your ISP

APN: The access point name of your ISP

Internet IP Address

Internet IP Address

- Get Dynamically From ISP
- Use Static IP Address . . .

Normally, The Internet IP Address of the router is allocated by the ISP automatically, you can also fix this address if the ISP agree.

Domain Name Server (DNS) Address

Domain Name Server (DNS) Address

- Get Automatically From ISP
- Use These DNS Servers
 - Primary DNS 202 . 101 . 103 . 55
 - Secondary DNS 202 . 101 . 98 . 55

Normally, the Domain Name Server (DNS) Address of the router is allocated by the ISP automatically. You can also use your own DNS address. If you want to use your own DNS, please make sure the DNS address you configured is usable and stable.

Keep Online Detection

Keep Online Detection

- Detection Method
- Detection Interval
- Primary Detection Server IP 166 . 111 . 8 . 238
- Backup Detection Server IP 202 . 119 . 32 . 102

This function is used to detect whether the Internet connection is active, if you set it and when the router detect the connection is inactive ,it will redial to you ISP immediately to make the connection active.

Detection Method:

None: do not set this function

Ping: Send ping packet to detect the connection, when choose this method, you should also configure "Detection Interval", "Primary Detection Server IP" and "Backup Detection Server IP" items.

Route: Detect connection with route method, when choose this method, you should also configure "Detection Interval", "Primary Detection Server IP" and "Backup Detection Server IP" items.

PPP: Detect connection with PPP method, when choose this method, you should also configure "Detection Interval" item.

Detection Interval: The time interval between two detections, unit is second

Primary Detection Server IP: The server used to response the router's detection packet. This item is only valid for method "Ping" and "Route".

Backup Detection Server IP: The server used to response the router's detection packet. This item is valid for method "Ping" and "Route".

Note: When you choose the "Route" or "Ping" method, it's quite important to make sure that the "Primary Detection Server IP" and "Backup Detection Server IP" are usable and stable, because they have to response the detection packet frequently.

3.3.3 WIFI Settings

WIFI enable

Wifi Enable

Wifi Enable: Enable Disable

Wifi Enable: Enable or disable WIFI function.

Wireless Network

Wireless Network

Name (SSID):

Region:

Channel:

Mode:

Name(SSID): Service Set Identifier which is also known as the wireless network name, A value of up to 32 alphanumeric characters.

Region: This item determines where to use the router, please choose the corresponding region you located .

Channel: this item determines which operating frequency is used.

Mode:

g and b: It provides backward compatibility with the slower 802.11b wireless devices while still enabling 802.11g communications.

b only: It supports the slower 802.11b wireless mode only.

g only: It supports the 802.11g wireless mode only.

Security Options: These options are the wireless security features you can enable.

Security Options

- Disable
- WEP
- WPA-PSK
- WPA2-PSK
- WPA/WPA2-PSK

Disable	No wireless security
WEP	Wired Equivalent Privacy
WPA-PSK	WI-FI Protected Access Pre-Shared Key
WPA2-PSK	WI-FI Protected Access Pre-Shared Key
WPA/WPA2-PSK	WI-FI Protected Access Pre-Shared Key

Configure WEP Wireless Security

When you choose WEP security options, the WEP configure page is as following:

Security Options

- Disable
- WEP
- WPA-PSK
- WPA2-PSK
- WPA/WPA2-PSK

Security Encryption (WEP)

Authentication Type:

Security Encryption (WEP) Key

WEP Key: (5 or 13 ascii characters)
Confirm:

Authentication Type: It can be “Open System”, ”Shared Key” or “Automatic” type.

Security Encryption(WEP) Key: WEP encryption key, It should be 5 or 13 characters.

Configure WPA-PSK Wireless Security

When you choose WPA-PSK option, the WPA-PSK configure page is as following:

Security Options

- Disable
- WEP
- WPA-PSK
- WPA2-PSK
- WPA/WPA2-PSK

Security Encryption

Encryption Method:

Passphrase: (8-63 characters)
Confirm: (8-63 characters)

Encryption Method: It can be “TKIP”, ”AES” or “AUTO” method.

Passphrase: A word or group of 8-63 printable characters

WPA2-PSK, WPA/WPA2-PSK configurations are the same as WPA-PSK.

Note:

[Xiamen Four-Faith Communication Technology Co.,Ltd.](http://www.fourfaith.com)

Page 20 of 40

Add: J1-J3,3rdFloor,No.44,GuanRiRoad,SoftWare Park,XiaMen .361008.China

http: //www.fourfaith.com Tel: +86 592-6300326 6300325 6300324 Fax: +86 592-5912735

Not all wireless adapters support WPA. Furthermore, client software is also required. Windows XP and Windows 2000 with Service Pack 3 do include WPA support. Nevertheless, the wireless adapter hardware and driver must also support WPA. For instructions on configuring wireless devices for WPA-PSK security, please consult the documentation for the product you are using.

3.3.4 LAN Settings

LAN TCP/IP Setup

IP Address	<input type="text" value="192"/>	<input type="text" value="168"/>	<input type="text" value="0"/>	<input type="text" value="1"/>		
IP Subnet Mask	<input type="text" value="255"/>	<input type="text" value="255"/>	<input type="text" value="255"/>	<input type="text" value="0"/>		
MAC Address	<input type="text" value="00"/>	<input type="text" value="00"/>	<input type="text" value="00"/>	<input type="text" value="00"/>	<input type="text" value="00"/>	<input type="text" value="22"/>

IP Address: the LAN port IP Address.

Note: If you change the LAN IP Address, you have to reboot the router to make it valid.

IP Subnet Mask: the LAN port subnet mask.

MAC Address: the LAN port Ethernet MAC Address

Use Router as DHCP Server

Starting IP Address	<input type="text" value="192"/>	<input type="text" value="168"/>	<input type="text" value="0"/>	<input type="text" value="11"/>
Ending IP Address	<input type="text" value="192"/>	<input type="text" value="168"/>	<input type="text" value="0"/>	<input type="text" value="254"/>

Use Router as DHCP Server: Enable or disable the router work as a DHCP server.

Starting IP Address: The starting IP Address of the DHCP server's Address pool

Ending IP Address: The ending IP Address of the DHCP server's Address pool

3.3.5 NAT

The router causes your entire local network to appear as a single machine to the Internet, You can make a local server visible and available to the Internet, This is done using the NAT (Network Address Translation). The NAT configuration page is as following:

Add a NAT item

Add NAT Items

Service Name

Service Type

Outside Starting Port (1~65534)

Inside Start Port (1~65534)

Port Numbers

Server IP Address . . .

Service Name: This NAT item's name

Service Type: The protocol type of the target packet

Outside Starting Port: The target packet's destination port

Inside Start Port: The destination port of packet which has been processed by the NAT module.

Port Numbers: Port numbers which will be processed by the router.

Server IP Address: Local server IP Address.

Example:

Configure an item as following

Add NAT Items

Service Name

Service Type

Outside Starting Port (1~65534)

Inside Start Port (1~65534)

Port Numbers

Server IP Address . . .

Once adding it, The custom NAT items table will displays this item

Custom NAT Items

Choose#	Service Name	Outside Start Port	Inside Start Port	Port Numbers	Server IP Address	Protocol
<input type="radio"/>	1 my_nat1	5001	5001	3	192.168.0.249	TCP

This item will make the router process packet with the destination port from 5001 ~ 5003 (total 3 port numbers), after processed by the NAT module, the destination port will be 5001~ 5003 correspondingly and the packet will be sent to host 192.168.0.249.

Delete a NAT item

To delete a NAT item, you should choose this item and press “Delete Item” button.

3.3.6 DMZ

Incoming traffic from the Internet is normally discarded by the router unless the traffic is a response to one of your local computers or a service that you have configured in the NAT page. Instead of discarding traffic for services you have not defined, you can have it forwarded to one computer on your network. This computer is called the Default DMZ Server.

Enable DMZ Enable Disable

DMZ IP . . .

Enable DMZ: Enable or disable DMZ function.

DMZ IP: DMZ server IP Address.

3.3.7 Filter

To block some packets getting Internet access or block some Internet packets getting local network access, you can configure filter items to block these packets.

Packet Filter

Packet filter function is realized based on IP address or port of packets.

Enable Packet Filter Enable Disable

Policy

Enable Packet Filter: Enable or disable “packet filter” function

Policy: The filter rule’s policy, you can choose the following options

Discard The Following--Discard all packets matched the custom filter rules, Accept all other packets

Only Accept The Following--Accept all packets matched the custom filter rules, Discard all other packets

Add Filter Item

Add Filter Item

Direction	<input type="text" value="output"/>
Protocol	<input type="text" value="TCP"/>
Source Port	<input type="text"/> (1~65534)
Destination Port	<input type="text"/> (1~65534)
Source IP	<input type="text"/> . <input type="text"/> . <input type="text"/> . <input type="text"/>
Destination IP	<input type="text"/> . <input type="text"/> . <input type="text"/> . <input type="text"/>
<input type="button" value="Add Item"/>	

Direction

input: packet from WAN to LAN

output: packet from LAN to WAN

Protocol: packet protocol type

Source Port: packet's source port

Destination Port: packet's destination port

Source IP: packet's source IP address

Destination IP: packet's destination IP address

Note:

"Source Port" , "Destination Port" , "Source IP" , "Destination IP" could not be all empty ,you have to input at least one of these four parameters.

Example:

If want to block local network PC 192.168.0.249 telnet(TCP port 23) to any other Internet Address ,the filter item could be configured as following:

Add Filter Item

Direction

Protocol

Source Port (1~65534)

Destination Port (1~65534)

Source IP . . .

Destination IP . . .

The following is the configured filter item:

Choose#	Source IP	Source Port	Destination IP	Destination Port	Direction	Protocol
<input type="radio"/> 1	192.168.0.249	*	*	23	output	TCP

MAC Restrict

This filter function is based on the Ethernet MAC address.

Enable MAC Restrict Enable Disable

Policy

Enable MAC Restrict: Enable or disable MAC Restrict function

Policy:

Discard The Following -- Discard all packets matched the custom MAC Restrict rules, Accept all other packets

Only Accept The Following -- Accept all packets matched the custom MAC Restrict rules, Discard all other packets

MAC Address : : : : :

MAC Address: The MAC Address applied to this MAC Restrict item.

3.3.8 Static Routes

Static Routes provide additional routing information to your router. Under normal circumstances, the router has adequate routing information after it has been configured for Internet access, and you do not need to configure additional static routes. You must configure static routes only for unusual cases such as configured VPN tunnel or multiple IP subnets located on your local network.

Static Routes

#	Name	Destination	Mask	Gateway
<input type="button" value="Add"/> <input type="button" value="Delete"/>				

Press “Add” button to start add a custom static route:

Static Routes

Route Name	<input type="text"/>
Destination IP Address	<input type="text"/> . <input type="text"/> . <input type="text"/> . <input type="text"/>
IP Subnet Mask	<input type="text"/> . <input type="text"/> . <input type="text"/> . <input type="text"/>
Gateway IP Address	<input type="text"/> . <input type="text"/> . <input type="text"/> . <input type="text"/>
Metric	<input type="text" value="3"/>
<input type="button" value="Apply"/> <input type="button" value="Cancel"/>	

Route Name: This static route’s name, It is for identification purpose only

Destination IP Address: The packet’s destination IP Address

IP Subnet Mask: The subnet mask for this destination, If the destination is a single host, please input 255.255.255.255

Gateway IP Address: The gateway IP Address of this packet.

Metric: A number between 1 and 15, It represents the number of routers between your network and the destination. Usually, a setting of 2 or 3 works

If you want to delete one custom static route, choose this item and press “Delete” button.

3.3.9 Router Status

This page displays the router's status information.

System

Account Name	admin
Firmware Version	V-1.0:2008-10-31 12:12:00
Module Type	SIEMENS MODULE

Account Name: The username to login the router.

Firmware Version: Software version information

Module Type: The wireless module used to get the Internet access

Internet Port

Status	online
IP Address	10.95.208.253
Gateway	10.64.64.64
Domain Name Server	211.138.151.161 211.136.18.171

Status: the current Internet access status

At State --- System is initialize the module

Dialing --- System is dialing to ISP

Online --- System has got Internet access

IP Address: The local Internet IP Address

Gateway: The ISP gateway IP Address

Domain Name Server: The Domain Name Server (DNS) IP Address.

LAN Port

IP Address	192.168.1.2
DHCP	Enable
IP Subnet Mask	255.255.255.0

IP Address: the LAN port IP Address

DHCP: the DHCP server status

IP Subnet Mask: The LAN port subnet mask

Wireless Port

Name (SSID)	AP1
Region	Asia
Channel	06
Mode	g and b
Wireless AP	ON

store the file. The default file name is “router-confnig.txt”. You can also give the file a more meaningful name.

To restore your configuration from a saved file, enter the full path to the file on your computer or click the “Browse” button to browse to the file. When you have located it, click the “Restore” button to send the file to the router to restore configuration.

3.3.11 Load Default

Load Default

Load Factory Default Settings

Load Default

It is sometimes desirable to restore the router to the factory default settings. This can be done by using the “Load Default” function, which will restore all factory settings.

To load default settings, please click the “Load Default” button. A prompt page will give you a choice to give up this operation or continue. Click “YES” button to load default and “No” to give up.

Load Default

Loading the Factory Default Settings will erase all the current settings.

Are you sure you want to do this?

Yes

No

3.3.12 Router Upgrade

The software of the router is stored in FLASH memory, and can be upgraded as new software is released by Four-Faith. Upgrade files can be downloaded from the Four-Faith Web site(www.four-faith.com). If the upgrade file is compressed (.ZIP file or .RAR), you must first extract the binary (.IMG) file before sending it to the router. The upgrade file can be sent to the router using your browser.

To upgrade new firmware , click the “Browse” button and browse to the location of the binary (.IMG) upgrade file, then click “Upload” button to start upgrade.

Xiamen Four-Faith Communication Technology Co.,Ltd.

Page 29 of 40

Add: J1-J3,3rdFloor,No.44,GuanRiRoad,SoftWare Park,XiaMen .361008.China

http: //www.fourfaith.com Tel: +86 592-6300326 6300325 6300324 Fax: +86 592-5912735

Router Upgrade

Locate and Select the Upgrade File from Your Hard Disk:

<input type="text"/>	<input type="button" value="Browse..."/>
<input type="button" value="Upload"/>	<input type="button" value="Cancel"/>

Note:

When uploading software to the Router, it is important not to interrupt the Web browser by closing the window, clicking a link, or loading a new page. If the browser is interrupted, it may corrupt the Router. It should not shutdown the power supply when uploading. When the upload is complete, your router will automatically restart and it will revert settings back to the factory defaults. The upgrade process will typically take about several minutes.

3.3.13 Set Password

The default username and password are both “admin” .

To change the username and password, type the new username ,old password and new password.

Set Password

User Name	<input type="text" value="admin"/>
Old Password	<input type="text"/>
New Password	<input type="text"/>
Repeat New Password	<input type="text"/>
<input type="button" value="Apply"/> <input type="button" value="Cancel"/>	

3.3.14 Logs

This function is used to debug the software, when there is some problem with the router, you can get the log information and send it to us to diagnose the problem. Normally this function should be disabled.

Logs

Enable Log Enable Disable

Log Way Web Console Syslog

Enable Log: Enable or disable this function

Log Way: there are three log ways

Web

Enable Log Enable Disable

Log Way Web Console Syslog

The log message is displayed on this web page. You can save the log message to a file by click “Save Log” button.

```

30--->
80 21 01 04 00 1c 03 06 00 00 00 02 06 00
0f 01 81 06 00 00 00 00 83 06 00 00 00 00
30--->
80 21 01 04 00 1c 03 06 00 00 00 02 06 00
0f 01 81 06 00 00 00 00 83 06 00 00 00 00
30--->
80 21 01 04 00 1c 03 06 00 00 00 02 06 00
0f 01 81 06 00 00 00 00 83 06 00 00 00 00
30--->
80 21 01 04 00 1c 03 06 00 00 00 02 06 00
0f 01 81 06 00 00 00 00 83 06 00 00 00 00
30--->
80 21 01 04 00 1c 03 06 00 00 00 02 06 00
0f 01 81 06 00 00 00 00 83 06 00 00 00 00

```

Console

Enable Log Enable Disable

Log Way Web Console Syslog . . .

The log message is output to the console port.

To use this way, you should connect the router’s console port and your PC’s serial port with the supplied console cable. Then open hyper terminal with the following serial port settings:

- Baud : 115200 bps
- Databit: 8
- Parity : None
- Stopbit: 1
- Flow control: None

When you configure the serial port settings , press “call” button ,The router log message will be displayed.

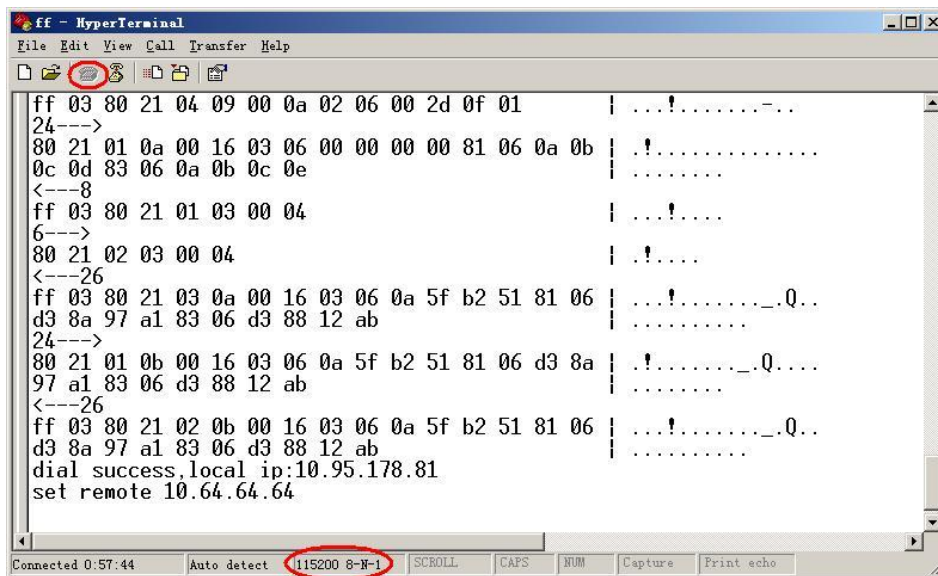

You can capture the log message into a file:

From the menu, choose “Transfer” →”capture text”

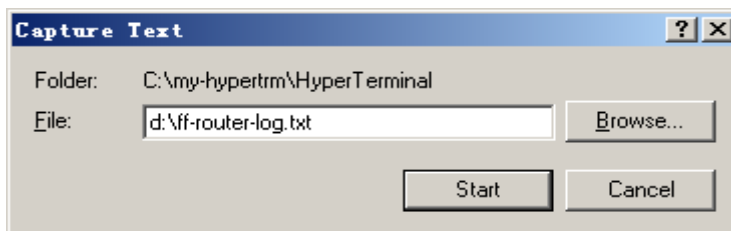

Input the log file name and press “start” button, the output message are now stored in the log file.

When enough message captured, you can stop capturing:

From the menu, choose “Transfer”→”capture text”→”stop”

Syslog

Enable Log Enable Disable

Log Way Web Console Syslog . . .

The log message is output to a syslog server, if choose this way, you should input a syslog server’s IP Address and run a syslog server program on it. .

3.3.15 Misc

Normally, the four-faith web config tool listens on port 80. If you want to change listening port, please configure “web config port” item.

Web Config Port

To reboot the router , press the “Reboot” button.

Reboot System

3.3.16 PPTP Client

PPTP Client

Enable PPTP Client

PPTP Server IP: . . .

Local Tunnel IP: Auto Fixed IP . . .

User Name:

Password:

Enable PPTP Client: Enable or disable PPTP Client function

PPTP Server IP: The PPTP server's IP Address

Local Tunnel IP: The local tunnel IP Address, if you choose "Auto", the Address is allocated by the PPTP Server dynamically. You can also use the fixed local tunnel IP if the PPTP Server support

User Name: Username to login the PPTP Server.

Password: Password to log into the PPTP Server.

3.3.17 L2TP Client

L2TP Client

Enable L2TP Client

L2TP Server IP (LNS): . . .

Local Tunnel IP: Auto Fixed IP . . .

User Name:

Password:

Enable L2TP Client: Enable or disable L2TP Client function

L2TP Server IP (LNS): The L2TP server's IP Address

Local Tunnel IP: The local tunnel IP Address, if you choose "Auto", the Address is allocated by the L2TP Server dynamically. You can also use the fixed local tunnel IP if the L2TP Server support

User Name: Username to login the L2TP Server.

Password: Password to login the L2TP Server.

3.3.18 IPSEC Client

Enable IPSEC Client

IPSEC Tunnel Name: Interface:

Peer WAN Address:

Peer ID:

Peer Subnet: (eg: 192.168.47.0/24)

Local ID:

Local Subnet: (eg: 192.168.1.0/24)

Authentication Method:

Pre-Shared Key:

Confirm Pre-Shared Key:

Perfect Forward Secrecy(PFS): Enable Disable

IKE Algorithm: IKE Encryption: IKE Integrity: IKE DH Group:

IPSEC 算法: IPSEC Encryption: IPSEC Integrity: IPSEC DH Group:

IKE Lifetime: (Seconds)

IPSEC Lifetime: (Seconds)

Debug Mode: Enable Disable

NAT-Traversal: Enable Disable

NAT Keepalive Interval: (Seconds)

Dead Peer Detection(DPD) Interval: (Seconds)

Dead Peer Detection(DPD) Timeout: (Seconds)

Connection detect enable: Enable Disable

Connection Detect Host:

Connection Detect Interval: (Seconds)

3.3.19 Dynamic DNS

If your network has a permanently assigned IP address, you can register a domain name and have that name linked with your IP address by public Domain Name Servers (DNS). However, if your Internet account uses a dynamically assigned IP address, you will not know in advance what your IP address will be, and the address can change frequently. In this case, you can use a commercial dynamic DNS service, which will allow you to register your domain to their IP address, and will forward traffic directed at your domain to your frequently-changing IP address.

The four-faith router currently support 88ip(www.88ip.net) and 3322(www.3322.org) Dynamic DNS provider.

88ip:

Dynamic DNS

Enable Dynamic DNS Service

Service Provider

Host Name

Backup Host Name

User Name

Password

Update Interval

- Enable Dynamic DNS Service: Enable DDNS service
- Service Provider: the DDNS service provider
- Host Name: The 88ip provider's server hostname
- Backup Host Name: The 88ip provider's backup server hostname
- User Name: Your 88ip account username
- Password: Your 88ip account password
- Update Interval: The time interval of IP Address update, unit is second

3322:

Dynamic DNS

Enable Dynamic DNS Service

Service Provider

Host Name

Customer Domain

User Name

Password

Update Interval

- Enable Dynamic DNS Service: Enable DDNS service
- Service Provider: the DDNS service provider
- Host Name: The 3322 provider's server hostname
- Customer Domain: Your custom 3322 domain name.
- User Name: Your 3322 account username

Password: Your 3322 account password

Update Interval: The time interval of IP Address update.

The “Show Status” button is used to display the current DDNS status.

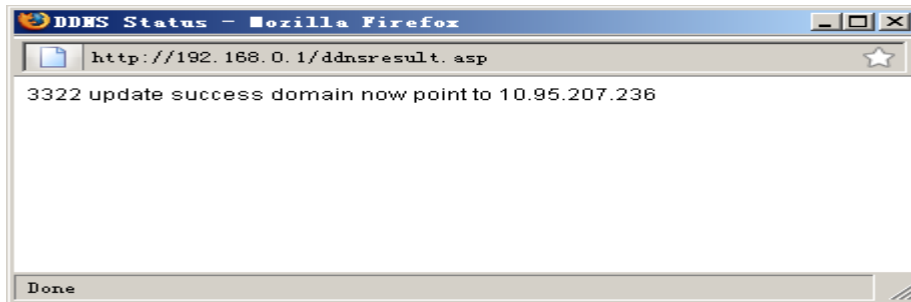

The above DDNS status page shows the domain name tomjerry555.3322.org now point to IP Address 10.95.207.236

3.3.20 Serial Settings

There is a console port on Four-Faith router. Normally, this port is used to debug the router. This port can also be used as a serial port. The router has embedded a serial to TCP program. The data sent to the serial port is encapsulated by TCP/IP protocol stack and then is sent to the destination server. This function can work as a Four-Faith DTU (Data Terminal Unit). Please refer www.four-faith.com for more information about this product.

Serial Settings

Baudrate:	115200
Databit:	8
Parity:	None
Stopbit:	1
Flow Control:	None
<input type="checkbox"/> Enable Serial TCP Function	
Protocol Type:	Pure TCP
Server Address	166.111.8.238
Server Port	23
Device ID	13312345678
Heartbeat Interval	60

Baudrate: The serial port’s baudrate

Databit: The serial port’s databit

Parity: The serial port's parity

Stopbit: The serial port's stopbit

Flow Control: The serial port's flow control type.

Enable Serial TCP Function: Enable the serial to TCP function

Protocol Type: The protocol type to transmit data.

UDP(DTU) – Data transmit with UDP protocol , work as a Four-Faith DTU which has application protocol and hear beat mechanism.

Pure UDP – Data transmit with standard UDP protocol.

TCP(DTU) -- Data transmit with TCP protocol , work as a Four-Faith DTU which has application protocol and hear beat mechanism.

Pure TCP -- Data transmit with standard TCP protocol.

Server Address: The data service center's IP Address or domain name.

Server Port: The data service center's listening port.

Device ID: The router's identity number.

Heartbeat Interval: The time interval to send heart beat packet. This item is valid only when you choose UDP(DTU) or TCP(DTU) protocol type.

Chapter 4 Appendix

The following steps describe how to setup Windows XP Hyper Terminal.

1. Press “Start”→”Programs”→”Accessories”→”Communications”→”Hyper Terminal”

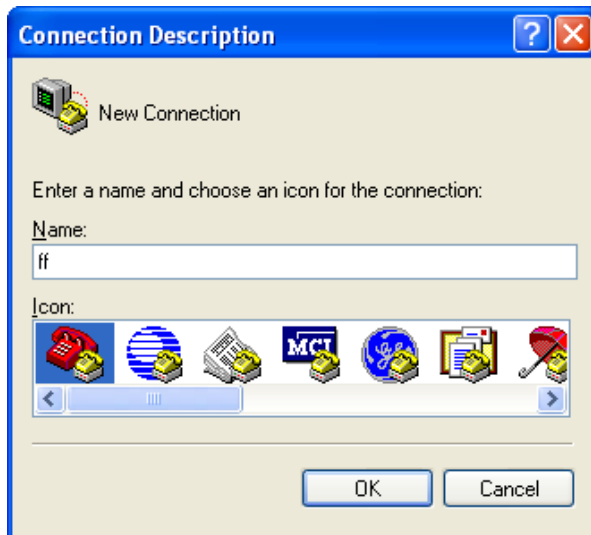

2. Input connection name, choose “OK”
3. Choose the correct COM port which connects to modem, choose “OK”



4. Configure the serial port parameters as following, choose “OK”

Bits per second: 115200

Data bits: 8
Parity: None
Stop bits: 1
Flow control: None

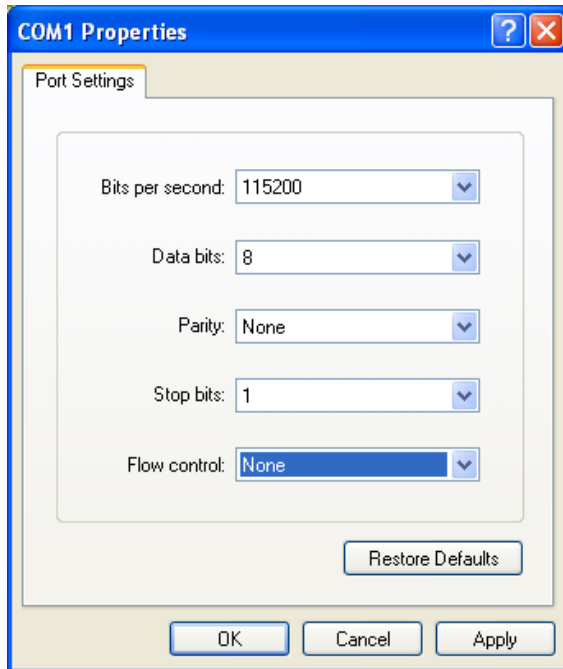

5. Complete Hyper Terminal operation, It runs as following

