

**FLUKE®**

**Model T100,  
T120,  
T140,  
VDE**

**Voltage/Continuity  
Tester**

**Users Manual**

November 2006

© 2006 Fluke Corporation. All rights reserved.

Printed in China

**References marked on instrument or in instruction manual:**

 Warning of a potential danger, comply with instruction manual.

 Reference. Please use utmost attention.

 Caution! Dangerous voltage. Danger of electrical shock.

 Continuous double or reinforced insulation complies with category II IEC 61140.

 Symbol for the marking of electrical and electronic equipment (WEEE Directive 2002/96/EC).

 Suitable for live working.

 VDE-approved, built- in compliance with the valid directives.

 Conformity symbol, the instrument complies with the valid directives. It complies with the EMV Directive (89/336/EEC). It also complies with the Low Voltage Directive (73/23/EEC).

**CAT III *Measuring Circuit Category CAT III:***

In addition to category II, the measuring circuit category III includes electric equipment subject to special demands with reference to safety and availability.

Examples: House installations, protective equipment, outlets, switches...

**CAT IV *Measuring Circuit Category CAT IV:***

Electric equipment, for which lightning voltage must also be taken into consideration, belongs to category IV. This includes, e.g. the connection to overhead circuits, underground cables to water pumps...

 The instruction manual contains information and references, necessary for safe operation and maintenance of the instrument. Prior to using the instrument read the instruction manual and comply with it in all sections.

 Failure to read the instruction manual or to comply with the warnings and references contained herein can result in serious bodily injury or instrument damage.

## ***Introduction / Scope of Supply***

The FLUKE T100/T120/T140 instruments are voltage and continuity testers with rotary field indication for universal applications. The voltage testers are constructed in accordance with the newest safety prescriptions and guarantee safe and reliable measurement and testing. The risk of injury when transporting the instrument in clothing pockets or in the tool box is eliminated due to the fixed test probe cover, as required by VBG 1 (BG) § 35 (Transporting Tools).

The voltage testers represent a valuable support for all testing and measurement in handcraft and industrial applications as well as for household uses.

The voltage testers FLUKE T100/ T120/ T140 characterised by the following features:

- Constructed in compliance with DIN EN 61243-3, DIN VDE 0682 Part 401 (previously DIN VDE 0680 Part 5), DIN VDE 0682 Part 401 A1, IEC61010
- Fixed test probe cover eliminates risk of injury (VBG 1, § 35 Transporting Tools)
- Digital LC-Display (only FLUKE T120/T140 )
- Resistance measurement (only T140 )
- LED (FLUKE T100)
- DC and AC voltage measurement up to 690V
- Single-pole phase test
- Continuity test / diode test
- Double-pole rotary direction determination
- IP 65 (IEC 60529, EN 60529, DIN VDE 0470-1)

After unpacking, verify that the instrument is undamaged. The scope of supply comprises:

- 1 FLUKE T100, T120 or T140
- 2 Batteries 1,5V IEC LR03 AAA
- 1 Users Manual

### Safety Measures

The instruments FLUKE T100/T120/T140 have been constructed and verified in compliance with the safety measures for voltage testers and have left the factory in safe and perfect condition.



In order to avoid electrical shock, the valid safety and VDE regulations regarding excessive contact voltages must receive utmost attention, when working with voltages exceeding 75V (60V) DC or 50V (25V)rms AC. The values in brackets are valid for special ranges (for example medicine and agriculture).



The detector shall not be used, if the battery box is open.



Prior to each test, ensure the proper condition of the measuring line and the measuring instrument, e.g. broken cables or leaking batteries.



Prior to measurement ensure that the test leads and the test instrument are in perfect condition.



When using this instrument only the handles of the probes may be touched .



This instrument may only be used within the ranges specified (see 6.0 Technical Data) and within voltage systems up to 690V



The measuring instrument may be used only in the measuring circuit category it has been designed for!



Instrument's faultless functionality must be verified prior to every use.

- 1) Short-circuit the probes. The Rx/Ohm LED must light up. If not, remove/replace the batteries.
- 2) Test the voltage tester on a known voltage source.





Prior to usage ensure perfect instrument function (e.g. on known voltage source).



The voltage testers may no longer be used if one or several functions fail or if no functionality is indicated.

 Do not measure under damp conditions.

 Perfect display is only guaranteed within a temperature range of  $-10^{\circ}\text{C}$  up to  $+55^{\circ}\text{C}$ , at relative humidity  $<85\%$

 If the operator's safety cannot be guaranteed, the instrument must be removed from service and protected against use.

Safety is no longer ensured in the following cases:

- Obvious damage
- When the device no longer performs the desired tests
- Excessive storage under unfavourable conditions
- Strain through transport
- Leaking batteries

For all the work, the accident prevention regulations of the commercial and industrial worker's compensation insurance carriers for electric installations and equipment must be heeded.

### ***Appropriate Usage***

The instrument may only be used under those conditions and for those purposes for which it was built. For this reason, in particular the safety references, the technical data including environmental conditions and the usage in dry environments must be followed.

 When modifying or changing the instrument, the operational safety is no longer ensured.

 The instrument may only be opened by an authorised service technician, e.g. for fuse replacement.

## **Control Elements and Connections**

- 1** Handle test probe - (L1)
- 2** Instrument test probe + (L2)
- 3** Measurement point illumination
- 4** LEDs for voltage display
- 5** LED for single-pole phase test
- 6** LED for left/right rotary field
- 7** LED for continuity
- 8** Polarity indication
- 9** LCD for voltage display (only FLUKE T120 and T140)
- 10** Button on rear side - for measurement point lightning (Also resistance measurement and RCD Trip Test in T140VDE)
- 11** Accessible electrode for double-pole determination of phase rotation and single-pole phase test
- 12** Battery case
- 13** Test probe protection

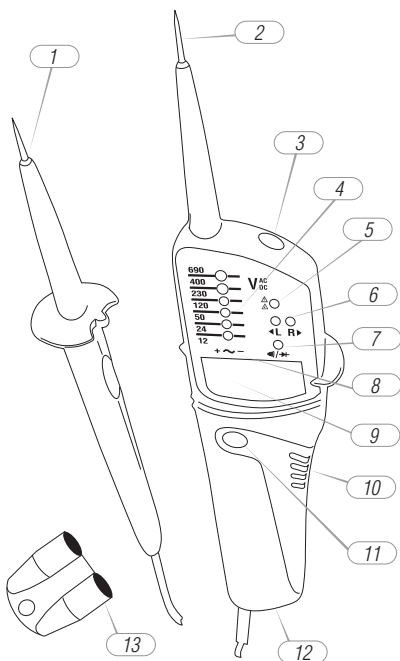

## Carrying out Measurements

### Preparation and Safety Measures

 For any test (measurement) the safety references have to be respected. Prior to any usage, a functional test has to be carried out.

Function test / Self test:

- Test the voltage tester on a known source.
- Connect the probes. A sound must be heard and the Rx/ $\Omega$  LED (7) must be lit. If the LED does not light up, the batteries need to be replaced.

 The voltage display of the instruments also functions when using discharged or no batteries > 20 V (LCD).

 The voltage testers may no longer be used if one or several functions fails or if no functional reliability can be detected.

 Remove discharged batteries from the device to prevent any leaks.

The instruments are equipped with an internal load enabling the tripping of an RCD protection device of 10mA or 30mA.

 For voltage tests (L towards PE) in systems with RCD devices, the RCD may be triggered. To avoid RCD tripping first test between L and N (approx. 5s). Immediately afterwards testing L towards PE can be carried out without RCD tripping (**not T140 VDE**)

### Voltage Test

 Safety measures have to be met

- Connect both test probes with UUT.

 From a voltage of < 12V the voltage tester switches on automatically.

 The voltage is indicated by LED (4) and for models FLUKE T120 and T140 also with a digital LCD (9).

 For AC voltages the "+" and "-" LEDs are illuminated.

 For DC voltage, the polarity of the voltage displayed refers to the instrument test probe (+).

 Due to technical reasons the instrument cannot effectuate an automatic switch-on for DC voltages within the range of approx. 0V to -3V.

## **Single-Pole Phase Test**

- To carry out single-pole phase tests touch the Accessible electrode (11) and connect instrument test probes to unknown contact.
- The single-pole phase test starts at an AC voltage of approx. 100V (pole > 100V AC).
- When using single-pole phase tests to determine external conductors the display function may be impaired under certain conditions (e.g. for insulating body protective equipment on insulation locations).
- The single-pole phase testing is not appropriate to determine whether a line is live or not. For this purpose, the double-pole voltage test is always required.

 The LED (5) is illuminated in the display.

## **Voltage Test with RCD Trip Test (not T140 VDE)**

During voltage tests in systems equipped with RCD circuit breakers, a RCD switch can be tripped at a nominal residual current of 10mA or 30mA by measuring the voltage between L and PE.

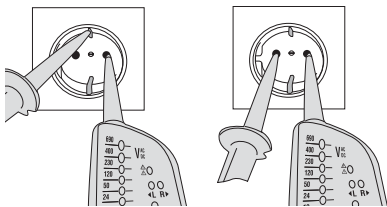

The RCD trips.

 To avoid RCD tripping a test has to be carried out between L and N during approx. 5s. Immediately afterwards, voltage testing between L and PE can be carried out without RCD tripping.



## **Voltage Test with RCD Trip Test (only T140 VDE)**

- 1) Press Button on rear side - measurement point light (10).
- 2) Measure between L and PE.
- 3) The RCD is tripping

 The RCD could be so long tripped like the measuring point lighting is active and L is measured against PE. After a voltage test wait approx.. 50 seconds to trip the RCD again.

## **Resistance Test (only T140 / T140 VDE)**

 Make sure that UUT is not live.

- Check that UUT is not live by carrying out a double-pole voltage test.
- Connect both test probes with UUT. Press Button on rear side - for measurement point light (10) and read value on the display.

 The resistance range is 1...1999  $\Omega$  at a resolution of 1  $\Omega$ .

 The resistance test is active for 20 seconds after having pressed the button on the rear.

 If during the resistance measurement a voltage is present the instrument switch automatically to voltage measurement.

## **Continuity Test / Diode Test**

 Make sure that UUT is not live. Test voltage polarity at handle test probe is positive (+).

- Check that UUT is not live by carrying out a double-pole voltage test.
- Connect both test probes with UUT. A signal sound is audible for continuity and the LED for continuity Rx/ $\Omega$  is illuminated.

## Rotary Field Indication

The voltage testers are equipped with a double-pole rotary field indicator.

 The safety measures have to be met

The rotary phase indication is always active. The symbols R ▶ or ◀ L are always displayed. However, the rotary direction can only be determined within a three-phase system. Here, the instrument indicates the voltage between two external conductors.

- Connect the instrument test probe with the supposed phase L2 and the handle test probe with the supposed phase L1.
- Touch Accessible electrode (11).

The voltage and the rotary field direction are displayed.

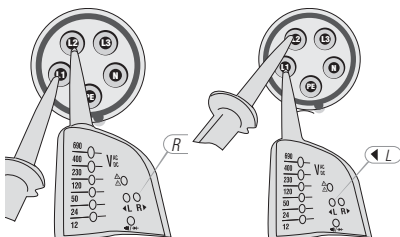

**R ▶** signifies that the supposed phase L1 is the actual phase L1 and the supposed phase L2 is the actual phase L2  
==> right rotary field

**◀ L** signifies that the supposed phase L1 is the actual phase L2 and the supposed phase L2 is the actual phase L1  
==> left rotary field.

 When re-testing with exchanged test probes the opposite symbol has to be illuminated.

## Measurement Point Illumination

Voltage testers T100re equipped with a measurement point illumination feature. Thus, working under bad lighting conditions (e.g. division switch cabinets) is made easier.

- Press button for measurement point illumination (10) on instrument rear.

 The measurement point illumination is active during approx. 45 seconds (only T140).

## **Maintenance**

When using FLUKE T100/T120/T140 testers in compliance with the instruction manual, no particular maintenance is required. If functional errors occur during normal operation, stop using it and contact your nearest authorized service center.

 If the device is not used for an extended period of time, the batteries must be removed to prevent the risk of leaking batteries and damage to the device.

## **Cleaning**

Prior to cleaning, remove voltage tester from all measurement circuits. If the instrument is dirty after daily usage, it is advisable clean it by using a damp cloth and a mild household detergent. Never use acid detergents or dissolvents for cleaning. After cleaning, do not use the voltage tester for a period of approx. 5 hours.

## **Calibration Interval**

The voltage testers must be calibrated periodically and checked by our service department at regular intervals to ensure the specified accuracy of measurement results. We recommend a calibration interval of one year.

## **Battery Replacement**

If the Rx/ $\Omega$  LED does not light up when the probes are short-circuited, the batteries must be replaced.

- Completely disconnect FLUKE T100/ T120/ T140 from the measurement circuit.
- Turn the battery case in direction of the arrow (e.g. using a coin). Then open and remove it.
- Remove discharged batteries.≠
- Replace with new batteries, type 1.5V IEC LR03 AAA respecting correct polarity.
- Insert the battery case and close it.

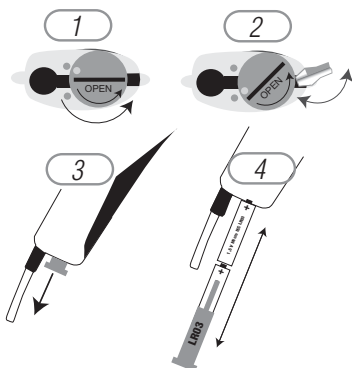

**!** When batteries have leaked, the device must not be used any longer. Before you can use it again, it must be checked by our customer service.

**!** Never try to dismantle a battery cell! The electrolyte in the cell is extremely alkaline and electroconductive. Risk of alkali burns! If electrolyte comes into contact with your skin or clothing, these spots must be rinsed with water immediately. If electrolyte got into your eye(s), rinse it (them) with water immediately and seek medical assistance.

Please consider your environment when you dispose of your one-way batteries or accumulators. They belong in a rubbish dump for hazardous waste. In most cases, the batteries can be returned to their point of sale.

**!** Please, comply with the respective valid regulation regarding the return, recycling and disposal of used batteries and accumulators.

## Technical Data

LED voltage range	12...690V AC/DC
LED resolution	±12, 24, 50, 120, 230, 400, 690V
Tolerance	complying to DIN VDE 0682, Part 401
LCD voltage range*	12V...690V AC/DC
LCD resolution*	1V
Tolerance*	±(3% rdg. + 5 digits)
Voltage detection	automatic
Polarity detection	full range
Range detection	automatic
Response time	<0.1s LED / <2s LCD
Frequency range	0...400Hz
Automatic load (RCD)	yes
Internal basic load	approx. 2.1 W at 690V
Peak current	I <sub>s</sub> <0,3A(5s), I <sub>n</sub> <3,5mA
Operation time	ED (DT) = 30s
Recovery time	240 seconds
Auto Power On	<12 V AC/DC

### Single-pole Phase Test

Voltage range	100...690V AC
Frequency range	50...400Hz
<b>Resistance Measurement**</b>	0...1999Ω/1Ω
Tolerance**	± (3 % rdg. + 10 digits) at 20 °C

Temperature coefficient: ...± 5 digits / 10 K

Test current\*\* <150μA

Overvoltage protection\*\* ...690V AC/DC

### Continuity Test

Continuity Test	0...400kΩ
Accuracy	RN +50%
Test current	< 5μA
Overvoltage protection	...690V AC/DC

### Rotary Field Indication

Voltage range (LEDs)	100...690V
Frequency range	50...60Hz
Measurement principle	double-pole and Accessible electrode
Power supply	2 x 1.5 V Micro IEC LR03
Power consumption	max. 30mA / approx. 250mW
Temperature range	-10°C...55°C
Humidity	max. 85% relative humidity
Height above sea level	up to 2000 m
Measurement category	CAT IV / 600V CAT III / 690V
Pollution degree	2
Protection degree	IP65
Safety complying to	DIN EN/IEC 61243-3, DIN VDE 0682 Part 401 (first DIN VDE 0680 Part 5, EN 61010, IEC 61010)
Weight	180g (incl. batteries)
Dimensions (HxWxD)	240 x 56 x 24mm

\* only T120,T140, T140VDE / \*\* only T140,T140VDE

# **Fluke T100/120/140**

## **Warranty**

---

### **LIMITED WARRANTY & LIMITATION OF LIABILITY**

This Fluke product will be free from defects in material and workmanship for one year from the date of purchase. This warranty does not cover fuses, disposable batteries, or damage from accident, neglect, misuse, alteration, contamination, or abnormal conditions of operation or handling. Resellers are not authorized to extend any other warranty on Fluke's behalf. To obtain service during the warranty period, contact your nearest Fluke authorized service center to obtain return authorization information, then send your defective tester to that Service Center with a description of the problem.

THIS WARRANTY IS YOUR ONLY REMEDY. NO OTHER WARRANTIES, SUCH AS FITNESS FOR A PARTICULAR PURPOSE, ARE EXPRESSED OR IMPLIED. FLUKE IS NOT LIABLE FOR ANY SPECIAL, INDIRECT, INCIDENTAL OR CONSEQUENTIAL DAMAGES OR LOSSES, ARISING FROM ANY CAUSE OR THEORY.

Since some states or countries do not allow the exclusion or limitation of an implied warranty or of incidental or consequential damages, this limitation of liability may not apply to you.

Fluke Corporation  
P.O. Box 9090  
Everett WA  
98206-9090

Fluke Europe B.V.  
P.O. Box 1186  
5602 B.D. Eindhoven  
Netherlands