

NI Ultiboard™

User Manual

Worldwide Technical Support and Product Information

ni.com

National Instruments Corporate Headquarters

11500 North Mopac Expressway Austin, Texas 78759-3504 USA Tel: 512 683 0100

Worldwide Offices

Australia 1800 300 800, Austria 43 662 457990-0, Belgium 32 (0) 2 757 0020, Brazil 55 11 3262 3599, Canada 800 433 3488, China 86 21 5050 9800, Czech Republic 420 224 235 774, Denmark 45 45 76 26 00, Finland 358 (0) 9 725 72511, France 01 57 66 24 24, Germany 49 89 7413130, India 91 80 41190000, Israel 972 3 6393737, Italy 39 02 41309277, Japan 0120-527196, Korea 82 02 3451 3400, Lebanon 961 (0) 1 33 28 28, Malaysia 1800 887710, Mexico 01 800 010 0793, Netherlands 31 (0) 348 433 466, New Zealand 0800 553 322, Norway 47 (0) 66 90 76 60, Poland 48 22 3390150, Portugal 351 210 311 210, Russia 7 495 783 6851, Singapore 1800 226 5886, Slovenia 386 3 425 42 00, South Africa 27 0 11 805 8197, Spain 34 91 640 0085, Sweden 46 (0) 8 587 895 00, Switzerland 41 56 2005151, Taiwan 886 02 2377 2222, Thailand 662 278 6777, Turkey 90 212 279 3031, United Kingdom 44 (0) 1635 523545

For further support information, refer to the *Technical Support and Professional Services* appendix. To comment on National Instruments documentation, refer to the National Instruments Web site at ni.com/info and enter the info code `feedback`.

Important Information

Warranty

The media on which you receive National Instruments software are warranted not to fail to execute programming instructions, due to defects in materials and workmanship, for a period of 90 days from date of shipment, as evidenced by receipts or other documentation. National Instruments will, at its option, repair or replace software media that do not execute programming instructions if National Instruments receives notice of such defects during the warranty period. National Instruments does not warrant that the operation of the software shall be uninterrupted or error free.

A Return Material Authorization (RMA) number must be obtained from the factory and clearly marked on the outside of the package before any equipment will be accepted for warranty work. National Instruments will pay the shipping costs of returning to the owner parts which are covered by warranty.

National Instruments believes that the information in this document is accurate. The document has been carefully reviewed for technical accuracy. In the event that technical or typographical errors exist, National Instruments reserves the right to make changes to subsequent editions of this document without prior notice to holders of this edition. The reader should consult National Instruments if errors are suspected. In no event shall National Instruments be liable for any damages arising out of or related to this document or the information contained in it.

EXCEPT AS SPECIFIED HEREIN, NATIONAL INSTRUMENTS MAKES NO WARRANTIES, EXPRESS OR IMPLIED, AND SPECIFICALLY DISCLAIMS ANY WARRANTY OF MERCHANTABILITY OR FITNESS FOR A PARTICULAR PURPOSE. CUSTOMER'S RIGHT TO RECOVER DAMAGES CAUSED BY FAULT OR NEGLIGENCE ON THE PART OF NATIONAL INSTRUMENTS SHALL BE LIMITED TO THE AMOUNT THEREFORE PAID BY THE CUSTOMER. NATIONAL INSTRUMENTS WILL NOT BE LIABLE FOR DAMAGES RESULTING FROM LOSS OF DATA, PROFITS, USE OF PRODUCTS, OR INCIDENTAL OR CONSEQUENTIAL DAMAGES, EVEN IF ADVISED OF THE POSSIBILITY THEREOF. This limitation of the liability of National Instruments will apply regardless of the form of action, whether in contract or tort, including negligence. Any action against National Instruments must be brought within one year after the cause of action accrues. National Instruments shall not be liable for any delay in performance due to causes beyond its reasonable control. The warranty provided herein does not cover damages, defects, malfunctions, or service failures caused by owner's failure to follow the National Instruments installation, operation, or maintenance instructions; owner's modification of the product; owner's abuse, misuse, or negligent acts; and power failure or surges, fire, flood, accident, actions of third parties, or other events outside reasonable control.

Copyright

Under the copyright laws, this publication may not be reproduced or transmitted in any form, electronic or mechanical, including photocopying, recording, storing in an information retrieval system, or translating, in whole or in part, without the prior written consent of National Instruments Corporation.

National Instruments respects the intellectual property of others, and we ask our users to do the same. NI software is protected by copyright and other intellectual property laws. Where NI software may be used to reproduce software or other materials belonging to others, you may use NI software only to reproduce materials that you may reproduce in accordance with the terms of any applicable license or other legal restriction.

Anti-Grain Geometry - Version 2.4

Copyright (C) 2002-2004 Maxim Shemanarev (McSeem)

Permission to copy, use, modify, sell and distribute this software is granted provided this copyright notice appears in all copies. This software is provided "as is" without express or implied warranty, and with no claim as to its suitability for any purpose.

Anti-Grain Geometry - Version 2.4

Copyright (C) 2002-2005 Maxim Shemanarev (McSeem)

1. Redistribution and use in source and binary forms, with or without modification, are permitted provided that the following conditions are met:
2. Redistributions of source code must retain the above copyright notice, this list of conditions and the following disclaimer.
3. Redistributions in binary form must reproduce the above copyright notice, this list of conditions and the following disclaimer in the documentation and/or other materials provided with the distribution.

The name of the author may not be used to endorse or promote products derived from this software without specific prior written permission.

THIS SOFTWARE IS PROVIDED BY THE AUTHOR "AS IS" AND ANY EXPRESS OR IMPLIED WARRANTIES, INCLUDING, BUT NOT LIMITED TO, THE IMPLIED WARRANTIES OF MERCHANTABILITY AND FITNESS FOR A PARTICULAR PURPOSE ARE DISCLAIMED. IN NO EVENT SHALL THE AUTHOR BE LIABLE FOR ANY DIRECT, INDIRECT, INCIDENTAL, SPECIAL, EXEMPLARY, OR CONSEQUENTIAL DAMAGES (INCLUDING, BUT NOT LIMITED TO, PROCUREMENT OF SUBSTITUTE GOODS OR SERVICES; LOSS OF USE, DATA, OR PROFITS; OR BUSINESS INTERRUPTION) HOWEVER CAUSED AND ON ANY THEORY OF LIABILITY, WHETHER IN CONTRACT, STRICT LIABILITY, OR TORT (INCLUDING NEGLIGENCE OR OTHERWISE) ARISING IN ANY WAY OUT OF THE USE OF THIS SOFTWARE, EVEN IF ADVISED OF THE POSSIBILITY OF SUCH DAMAGE.

Trademarks

National Instruments, NI, ni.com, and LabVIEW are trademarks of National Instruments Corporation. Refer to the *Terms of Use* section on ni.com/legal for more information about National Instruments trademarks.

Ultiboard is a registered trademark and Multisim and Electronics Workbench are trademarks of Electronics Workbench.

Portions of this product obtained under license from Bartels Systems GmbH.

Other product and company names mentioned herein are trademarks or trade names of their respective companies.

Members of the National Instruments Alliance Partner Program are business entities independent from National Instruments and have no agency, partnership, or joint-venture relationship with National Instruments.

Patents

For patents covering National Instruments products, refer to the appropriate location: **Help»Patents** in your software, the `patents.txt` file on your media, or ni.com/patents.

WARNING REGARDING USE OF NATIONAL INSTRUMENTS PRODUCTS

(1) NATIONAL INSTRUMENTS PRODUCTS ARE NOT DESIGNED WITH COMPONENTS AND TESTING FOR A LEVEL OF RELIABILITY SUITABLE FOR USE IN OR IN CONNECTION WITH SURGICAL IMPLANTS OR AS CRITICAL COMPONENTS IN ANY LIFE SUPPORT SYSTEMS WHOSE FAILURE TO PERFORM CAN REASONABLY BE EXPECTED TO CAUSE SIGNIFICANT INJURY TO A HUMAN.

(2) IN ANY APPLICATION, INCLUDING THE ABOVE, RELIABILITY OF OPERATION OF THE SOFTWARE PRODUCTS CAN BE IMPAIRED BY ADVERSE FACTORS, INCLUDING BUT NOT LIMITED TO FLUCTUATIONS IN ELECTRICAL POWER SUPPLY, COMPUTER HARDWARE MALFUNCTIONS, COMPUTER OPERATING SYSTEM SOFTWARE FITNESS, FITNESS OF COMPILERS AND DEVELOPMENT SOFTWARE USED TO DEVELOP AN APPLICATION, INSTALLATION ERRORS, SOFTWARE AND HARDWARE COMPATIBILITY PROBLEMS, MALFUNCTIONS OR FAILURES OF ELECTRONIC MONITORING OR CONTROL DEVICES, TRANSIENT FAILURES OF ELECTRONIC SYSTEMS (HARDWARE AND/OR SOFTWARE), UNANTICIPATED USES OR MISUSES, OR ERRORS ON THE PART OF THE USER OR APPLICATIONS DESIGNER (ADVERSE FACTORS SUCH AS THESE ARE HEREAFTER COLLECTIVELY TERMED "SYSTEM FAILURES"). ANY APPLICATION WHERE A SYSTEM FAILURE WOULD CREATE A RISK OF HARM TO PROPERTY OR PERSONS (INCLUDING THE RISK OF BODILY INJURY AND DEATH) SHOULD NOT BE RELIANT SOLELY UPON ONE FORM OF ELECTRONIC SYSTEM DUE TO THE RISK OF SYSTEM FAILURE. TO AVOID DAMAGE, INJURY, OR DEATH, THE USER OR APPLICATION DESIGNER MUST TAKE REASONABLY PRUDENT STEPS TO PROTECT AGAINST SYSTEM FAILURES, INCLUDING BUT NOT LIMITED TO BACK-UP OR SHUT DOWN MECHANISMS. BECAUSE EACH END-USER SYSTEM IS CUSTOMIZED AND DIFFERS FROM NATIONAL INSTRUMENTS' TESTING PLATFORMS AND BECAUSE A USER OR APPLICATION DESIGNER MAY USE NATIONAL INSTRUMENTS PRODUCTS IN COMBINATION WITH OTHER PRODUCTS IN A MANNER NOT EVALUATED OR CONTEMPLATED BY NATIONAL INSTRUMENTS, THE USER OR APPLICATION DESIGNER IS ULTIMATELY RESPONSIBLE FOR VERIFYING AND VALIDATING THE SUITABILITY OF NATIONAL INSTRUMENTS PRODUCTS WHENEVER NATIONAL INSTRUMENTS PRODUCTS ARE INCORPORATED IN A SYSTEM OR APPLICATION, INCLUDING, WITHOUT LIMITATION, THE APPROPRIATE DESIGN, PROCESS AND SAFETY LEVEL OF SUCH SYSTEM OR APPLICATION.

Conventions

The following conventions are used in this manual:

» The » symbol leads you through nested menu items and dialog box options to a final action. The sequence **File»Page Setup»Options** directs you to pull down the **File** menu, select the **Page Setup** item, and select **Options** from the last dialog box.



This icon denotes a tip, which alerts you to advisory information.



This icon denotes a note, which alerts you to important information.



This icon denotes a caution, which advises you of precautions to take to avoid injury, data loss, or a system crash.

bold

Bold text denotes items that you must select or click in the software, such as menu items and dialog box options. Bold text also denotes parameter names.

italic

Italic text denotes variables, emphasis, a cross-reference, or an introduction to a key concept. Italic text also denotes text that is a placeholder for a word or value that you must supply.

monospace

Text in this font denotes text or characters that you should enter from the keyboard, sections of code, programming examples, and syntax examples. This font is also used for the proper names of disk drives, paths, directories, programs, subprograms, subroutines, device names, functions, operations, variables, filenames, and extensions.

Contents

Chapter 1 User Interface

Introduction to the Ultiboard Interface	1-1
Toolbars	1-1
Standard Toolbar	1-1
View Toolbar	1-3
Main Toolbar	1-4
Select Toolbar	1-5
Draw Settings Toolbar	1-6
Edit Toolbar	1-7
Align Toolbar	1-8
Place Toolbar	1-9
Wizard Toolbar	1-12
Autoroute Toolbar	1-12
Setting Preferences	1-13
General Tab	1-13
Paths Tab	1-14
Colors Tab	1-15
PCB Design Tab	1-15
Dimensions Tab	1-18
3D Options Tab	1-19
Setting PCB Properties	1-20
Attributes Tab	1-20
Grid & Units Tab	1-20
Copper Layers Tab	1-21
Pads/Vias Tab	1-22
General Layers Tab	1-24
Design Rules Tab	1-25
Setting Favorite Layers	1-26
Design Toolbox	1-27
Birds Eye View	1-28
Spreadsheet View	1-29
Spreadsheet View: DRC Tab	1-30
Filter Manager	1-31
Spreadsheet View: Results Tab	1-32
Spreadsheet View: Parts Tab	1-33
Spreadsheet View: Part Groups Tab	1-34
Spreadsheet View: Nets Tab	1-35
Spreadsheet View: Nets Groups Tab	1-38

Spreadsheet View: SMT Pads Tab.....	1-39
Spreadsheet View: THT Pads Tab.....	1-40
Spreadsheet View: Vias Tab.....	1-42
Spreadsheet View: Copper Areas Tab.....	1-43
Spreadsheet View: Keep-ins/Keep-outs Tab.....	1-44
Spreadsheet View: PCB Layers Tab.....	1-45
Spreadsheet View: Parts Position Tab.....	1-45
Spreadsheet View: Statistics Tab.....	1-46
Customizing the Interface.....	1-46
Commands Tab.....	1-47
Toolbars Tab.....	1-47
Keyboard Tab.....	1-48
Menu Tab.....	1-48
Options Tab.....	1-49
Customization of Pop-up Menus.....	1-49

Chapter 2

Beginning a Design

About Designs and Projects.....	2-1
Creating a Project.....	2-1
Creating a Design.....	2-2
Creating a Design from a Netlist File.....	2-2
Working with Projects.....	2-4
Opening an Existing File.....	2-5
Saving and Closing.....	2-5
Saving Technology Specifications from a Design.....	2-6
Loading Technology Files.....	2-6
Selecting and Unselecting Elements.....	2-7
Place and Select Modes.....	2-8
Searching for Design Elements.....	2-8
Options for Viewing the Design.....	2-9
Using the Full Screen.....	2-9
Magnifying and Shrinking the View.....	2-10
Refreshing the Design.....	2-11
Tool-tip Label.....	2-11

Chapter 3

Setting Up a Design

Working with Layers.....	3-1
Defining Copper Layers.....	3-1
Accessing Layers.....	3-3

Working with the Board Outline	3-5
Using the Drawing Tools to Create a Board Outline	3-5
Importing a DXF File	3-6
Using a Pre-Defined Board Outline	3-6
Using the Board Wizard	3-7
Setting the Board's Reference Point	3-8
Enter coordinate dialog box.....	3-9
Design Rule Errors.....	3-10
Working with the Group Editor	3-11
Add Group dialog box	3-11
Working with Net Groups	3-12
Working with Part Groups.....	3-13
Working with Bus Groups.....	3-15
Working with Differential Pairs	3-17
Change Group Settings dialog box.....	3-18
Net Group Settings.....	3-19
Part Group Settings	3-19
Differential Pair Settings.....	3-20

Chapter 4

Working with Parts

Placing Parts	4-1
Dragging Parts from Outside the Board Outline	4-1
Using the Parts Tab in the Spreadsheet View	4-2
Using the Parts Tab to Place Parts	4-3
Using the Parts Tab for Other Functions	4-4
Tools to Assist Part Placement.....	4-5
Working with Ratsnests	4-5
Working with Force Vectors.....	4-6
Dragging Parts.....	4-7
Shoving Parts	4-7
Using Ruler Bars and Guides.....	4-10
Orienting Parts	4-11
Aligning Shapes and Parts	4-11
Spacing Shapes and Parts.....	4-12
Placing a Group Array Box.....	4-12
Replicating a Group	4-14
Unplacing Parts	4-15
Viewing and Editing Properties	4-15
Attributes	4-15
Viewing and Editing Part Properties	4-17
Viewing and Editing Attributes.....	4-19
Viewing and Editing Shape/Graphics Properties	4-20

Placing Other Elements	4-20
Placing Mounting Holes and Connectors.....	4-21
Placing Holes	4-21
Placing Shapes and Graphics	4-21
Working with Jumpers	4-23
Placing Jumpers.....	4-23
Viewing and Editing Jumper Properties	4-23
Working with Test Points	4-24
Placing Test Points	4-24
Viewing and Editing Test Point Properties	4-25
Working with Dimensions	4-25
Placing Dimensions	4-25
Viewing and Editing Dimension Properties	4-26
Placing Parts from the Database.....	4-27
Editing Parts and Shapes	4-29
Editing a Placed Part (In-Place Edit)	4-29
Editing a Polygon.....	4-30
Viewing and Editing Through Hole Pin Properties	4-31
Viewing and Editing SMT Pin Properties.....	4-33
Searching For and Replacing Parts.....	4-34
Searching for Parts in Open Designs	4-34
Locating a Part in a Design	4-34
Replacing Parts	4-35
Cross-probing	4-35
Creating New Parts.....	4-35
Using the Database Manager to Create a Part.....	4-35
Using the Part Wizard to Create a Part	4-36
Managing the Database	4-41
Working with Database Categories.....	4-43
Adding Parts to the Database	4-44
Adding Parts using the Database Manager.....	4-45
Adding Parts using the Add Selection to Database Command	4-45
Merging and Converting Databases	4-46
Merging Databases.....	4-46
Converting Databases	4-47

Chapter 5

Working with Traces and Copper

Placing Traces	5-1
Working with Traces.....	5-2
Placing a Trace: Manual Method.....	5-2
Placing a Trace: Follow-me Method.....	5-3
Placing a Trace: Connection Machine Method.....	5-4

Placing a Bus	5-5
Working with Density Bars	5-6
Working with Keep-in/Keep-out Areas.....	5-7
Placing Keep-in/Keep-out Areas	5-7
Viewing and Editing Keep-in/Keep-out Properties	5-7
Equi-Spacing Traces.....	5-9
Deleting a Trace	5-9
Working with Other Copper Elements	5-10
Placing Copper Areas	5-10
Placing Powerplanes.....	5-11
Splitting Copper.....	5-11
Converting a Copper Shape to an Area	5-12
Deleting All Copper	5-12
Adding and Removing Teardrops	5-13
Viewing and Editing Copper Properties	5-13
Working with Vias	5-15
Placing Vias.....	5-15
Viewing and Editing Via Properties.....	5-16
Placing SMD Fanouts	5-18
Working with Nets	5-19
Using the Nets Tab	5-19
Using the Netlist Editor	5-20
Adding a Net	5-21
Renaming a Net.....	5-25
Deleting a Net	5-25
Deleting a Pin from a Net	5-26
Setting Net Widths	5-26
Setting High Speed Parameters.....	5-26
Setting Miscellaneous Net Parameters.....	5-27
Setting Group Parameters	5-27
Setting Via Parameters.....	5-28
Highlighting a Net	5-28
Shielding Nets	5-28
Net Bridges.....	5-30
Creating a Net Bridge	5-30
Placing a Net Bridge	5-32
Copying a Copper Route	5-33
Swapping Pins and Gates.....	5-34
Swapping Pins	5-34
Swapping Gates	5-35
Automatic Pin/Gate Swapping	5-38
Real-Time Pin/Gate Swapping	5-39

Chapter 6

PCB Calculators

PCB Transmission Line Calculator.....	6-1
Microstrip Trace Calculations.....	6-2
Embedded Microstrip Trace Calculations.....	6-3
Centered Stripline Trace Calculations	6-4
Asymmetric Stripline Trace Calculations	6-5
Dual Stripline Trace Calculations	6-6
PCB Differential Impedance Calculator.....	6-7
Microstrip Calculations.....	6-8
Embedded Microstrip Calculations.....	6-9
Centered Stripline Calculations	6-11
Asymmetric Stripline Calculations	6-12

Chapter 7

Automating and Autoplacement

Autoroute Menu Items.....	7-1
Autoplacement of Parts	7-2
Pre-Placing Parts	7-2
Understanding How the Autoplacer Works	7-2
Running the Autoplacer	7-3
Controlling the Autoplacer	7-3
Strategies to Achieve Better Part Placement.....	7-5
Automating.....	7-6
Understanding How the Autorouter Works	7-6
Understanding the Four Fundamental Routing Functions	7-7
Router Preprocessing.....	7-7
Initial Routing.....	7-7
Rip-up and Retry Routing.....	7-7
Optimization	7-8
Routing Selected Parts and Nets	7-8
Running the Autorouter	7-8
Interactivity.....	7-9
Automating buses	7-9
Placing Automatic Test Points.....	7-10
Controlling the Routing Functions.....	7-11
Routing Options: General Tab.....	7-11
Routing Options: Cost Factors Tab	7-12
Routing Options: Rip-Up Tab	7-14
Routing Options: Optimization Tab	7-15
Routing Options: Bus Autorouting Tab.....	7-16
Strategies to Achieve Better Routing Results	7-17

Chapter 8

Preparing for Manufacturing/Assembly

Placing and Editing Text.....	8-1
Capturing Screen Area.....	8-2
Placing a Comment.....	8-3
Renumbering Parts.....	8-5
Backannotation to Multisim.....	8-6
Mitering Corners.....	8-6
Manually Re-Running the Design Rules and Netlist Check.....	8-8
Cleaning up the Board.....	8-8
Deleting Open Trace Ends.....	8-8
Deleting Unused Vias.....	8-8
Exporting a File.....	8-8
Using Export Settings.....	8-9
Viewing and Editing Export Properties.....	8-10
Setting Gerber Properties.....	8-10
Setting DXF Properties.....	8-11
Setting NC Drill Properties.....	8-11
Working with SVG Properties.....	8-11
Working with other Properties.....	8-12
Exporting the Desired File.....	8-14
Printing your Design.....	8-14
Previewing the Printed Design.....	8-15

Chapter 9

Viewing Designs in 3D

Viewing the Board in 3D.....	9-1
Manipulating the 3D View.....	9-2
Controlling the Elements Viewed in 3D.....	9-3
Showing an Object's Height.....	9-4
Internal View.....	9-4
Exporting to 3D DXF.....	9-5
Exporting to 3D IGES.....	9-6

Chapter 10

Using Mechanical CAD

Creating Mechanical CAD Projects.....	10-1
Creating Mechanical CAD Design Files.....	10-2
Importing a DXF File.....	10-3
Setting Mechanical CAD Properties and Options.....	10-3
Setting Mechanical CAD Properties.....	10-3

Setting Mechanical CAD Colors.....	10-3
Controlling Workspace Elements for Mechanical CAD.....	10-4
Setting Paths for Mechanical CAD.....	10-5
Setting Mechanical CAD Dimensions	10-5

Appendix A Menus and Commands

File Menu.....	A-1
File»New Design.....	A-1
File»New Project.....	A-1
File»Open.....	A-1
File»Open Samples	A-1
File»Save.....	A-1
File»Save As	A-2
File»Save All.....	A-2
File»Close	A-2
File»Close Project.....	A-2
File»Close All	A-2
File»Import.....	A-2
File»Export.....	A-2
File»Save Technology.....	A-2
File»Load Technology	A-2
File»Print Setup.....	A-3
File»Print Preview.....	A-3
File»Print.....	A-3
File»Recent Designs	A-3
File»Exit.....	A-3
Edit Menu	A-3
Edit»Undo	A-3
Edit»Redo.....	A-3
Edit»Cut	A-4
Edit»Copy	A-4
Edit»Paste.....	A-4
Edit»Paste Special.....	A-4
Edit»Delete.....	A-4
Edit»Copper Delete.....	A-4
Edit»Find.....	A-5
Edit»Select All	A-5
Edit»Select Entire Trace	A-5
Edit»Group Selection.....	A-5
Edit»Ungroup Selection.....	A-5
Edit»Lock.....	A-5
Edit»Unlock	A-5

Edit»Selection Filter	A-6
Edit»Orientation	A-6
Edit»Align	A-6
Edit»Vertex.....	A-7
Edit»In-Place Part Edit	A-7
Edit»Properties	A-7
View Menu	A-8
View»Full Screen	A-8
View»Redraw Screen	A-8
View»Zoom In.....	A-8
View»Zoom Out.....	A-8
View»Zoom Window	A-8
View»Zoom Full	A-8
View»Clearances	A-8
View»Grid	A-8
View»Ruler Bars	A-9
View»Status Bar.....	A-9
View»Density Bars.....	A-9
View»Birds Eye.....	A-9
View»Design Toolbox.....	A-9
View»Spreadsheet View	A-9
View»3D Preview	A-9
View»Toolbars	A-9
Place Menu	A-10
Place»From Database	A-10
Place»Line	A-10
Place»Select.....	A-10
Place»Follow-me	A-11
Place»Connection Machine	A-11
Place»Shape.....	A-11
Place»Dimension	A-11
Place»Graphic»Line	A-11
Place»Graphic»Arc.....	A-12
Place»Graphic»Bezier	A-12
Place»Graphic»Picture	A-12
Place»Graphic»Text	A-12
Place»Copper Area.....	A-12
Place»Powerplane.....	A-12
Place»Bus	A-12
Place»Keep-in/Keep-out Area.....	A-13
Place»Group Array Box	A-13
Place»Pins.....	A-13
Place»Via.....	A-13
Place»Test Point	A-13

Place»Jumper	A-13
Place»Net Bridge	A-13
Place»Hole	A-13
Place»Automatic Test Points	A-14
Place»Unplace Parts.....	A-14
Place»Comment	A-14
Design Menu	A-14
Design»Netlist & DRC Check	A-14
Design»Connectivity Check	A-14
Design»Polygon Splitter	A-15
Design»Shape to Area.....	A-15
Design»Swap Pins.....	A-15
Design»Swap Gates	A-15
Design»Automatic Pin Gate Swap.....	A-15
Design»Part Shoving.....	A-15
Design»Set Reference Point.....	A-15
Design»Shield Nets	A-15
Design»Fanout SMD.....	A-16
Design»Add Teardrops	A-16
Design»Corner Mitering	A-16
Design»Remove Unused Vias	A-16
Design»Group Replica Place	A-16
Design»Copy Route	A-16
Design»Highlight Selected Net.....	A-16
Tools Menu.....	A-17
Tools»Board Wizard	A-17
Tools»Part Wizard	A-17
Tools»Database»Database Manager	A-17
Tools»Database»Add Selection to Database	A-17
Tools»Database»Set Database Password.....	A-17
Tools»Database»Merge Database.....	A-17
Tools»Database»Convert Database	A-18
Tools»PCB Transmission Line Calculator	A-18
Tools»PCB Differential Impedance Calculator	A-18
Tools»Netlist Editor	A-18
Tools»Group Editor	A-18
Tools»Quick Layer Toggle	A-18
Tools»Renumber Parts.....	A-18
Tools»Equi-space Traces	A-19
Tools»Change Shape.....	A-19
Tools»Update Shapes.....	A-19
Tools»Highlight Selection in Multisim.....	A-19
Tools»Capture Screen Area	A-19
Tools»View 3D	A-19

Tools»View 3D Position	A-19
Tools»Show or Hide Height.....	A-19
Options Menu	A-20
Options»Global Preferences.....	A-20
Options»PCB Properties.....	A-20
Options»Customize User Interface.....	A-20
Autoroute Menu	A-20
Window Menu	A-20
Window»New Window	A-20
Window»Close	A-20
Window»Close All.....	A-21
Window»Cascade	A-21
Window»Tile Horizontal.....	A-21
Window»Tile Vertical.....	A-21
Window»Windows.....	A-21
Window»<open designs>	A-21
Help Menu	A-21
Help»Ultiboard Help	A-21
Help»Release Notes.....	A-21
Help»Patents.....	A-21
Help»File Information	A-21
Help»About Ultiboard.....	A-22
Context Menus	A-22
Select Menu	A-22
Right-drag Menu	A-24
Place Trace Menu	A-24

Appendix B

Archiving Data

Backing up the Corporate Database.....	B-1
Backing up the User Database and Configuration files	B-2

Appendix C

Technical Support and Professional Services

Glossary

Index

User Interface

The following sections explain the basic components of the Ultiboard Graphical User Interface (GUI) and show how to set up user preferences and PCB properties.

Some of the described features may not be available in your edition of Ultiboard. Refer to the NI Circuit Design Suite Release Notes for a list of the features in your edition.

Introduction to the Ultiboard Interface

Ultiboard is the PCB layout application of National Instruments Circuit Design Suite, a suite of EDA (Electronics Design Automation) tools that assists you in carrying out the major steps in the circuit design flow. Ultiboard is used to design printed circuit boards, perform certain basic mechanical CAD operations, and prepare them for manufacturing. It also provides automated parts placement and layout.













Note For more information on the Ultiboard interface, and information on the other components of NI Circuit Design Suite, refer to *Getting Started with NI Circuit Design Suite*.

Toolbars

The toolbars provide a quick, convenient way for you to access the most common Ultiboard functions. You can toggle toolbars on and off using the **View>Toolbars** menu.







Standard Toolbar

The **Standard** toolbar contains buttons for basic editing functions, and appears by default when you run Ultiboard. The **Standard** toolbar buttons are described in the table below.

Button	Description
	New File button. Creates a new project (if none are currently open) or a new design if a project is currently open. Refer to the Creating a Project and Creating a Design sections of Chapter 2, Beginning a Design , for more information.
	Open File button. Opens an existing project. Refer to the Opening an Existing File section of Chapter 2, Beginning a Design , for more information.
	Open Sample button. Opens the samples folder.
	Save File button. Saves the active design to its current name and directory. Refer to the Saving and Closing section of Chapter 2, Beginning a Design , for more information.
	Print button. Displays the Print dialog. Refer to the Printing your Design section of Chapter 8, Preparing for Manufacturing/Assembly , for more information.
	Cut button. Cuts the selected element from the design and places it on the Windows Clipboard.
	Copy button. Copies the selected element from the design and places it on the Windows Clipboard.
	Paste button. Pastes the element from the Windows Clipboard to the design.
	Undo button. Undoes the last action.
	Redo button. Redoes the last action (used after undoing).









View Toolbar







The **View** toolbar contains buttons for modifying the way the screen is displayed, and appears by default when you run Ultiboard. The **View** toolbar buttons are explained in the table below.

Button	Description
	<p>Redraw the Screen button. Redraws the currently active design workspace. Refer to the <i>Refreshing the Design</i> section of Chapter 2, <i>Beginning a Design</i>, for more information.</p>
	<p>Toggle Full Screen button. Adjusts the size of the workspace so it displays the entire design. Refer to the <i>Using the Full Screen</i> section of of Chapter 2, <i>Beginning a Design</i>, for more information.</p>
	<p>Zoom In button. Zooms in on the design, providing a closer view. Refer to the <i>Magnifying and Shrinking the View</i> section of Chapter 2, <i>Beginning a Design</i>, for more information.</p>
	<p>Zoom Out button. Zooms out on the design, providing a broader view.</p>
	<p>Zoom Window button. Magnifies a selected part of the design. Refer to the <i>Magnifying and Shrinking the View</i> section of Chapter 2, <i>Beginning a Design</i>, for more information.</p>
	<p>Zoom Bounds button. Shows the entire design, including objects that are outside of the board outline.</p>

Main Toolbar



The **Main** toolbar contains buttons for common board design functions. Its buttons are described in the table below.







Button	Description
	Select button. De-activates any selected mode (for example, for placing traces) and allows you to select an element on the board.
	Show or Hide Design Toolbox button. Shows or hides the Design Toolbox . Refer to the Design Toolbox section for more information.
	Show or Hide Spreadsheet button. Shows or hides the Spreadsheet View . Refer to the Spreadsheet View section for more information.
	Database Manager button. Displays the Database Manager . Refer to the Managing the Database section of Chapter 4, Working with Parts , for more information.
	Board Wizard button. Launches the Board Wizard . Refer to the Using the Board Wizard section of Chapter 3, Setting Up a Design , for more information.
	Part Wizard button. Starts the Part Wizard . Refer to the Using the Part Wizard to Create a Part section of Chapter 4, Working with Parts , for more information.
	Place Part from Database button. Allows you to browse the database for a part to place. Refer to the Placing Parts from the Database section of Chapter 4, Working with Parts , for more information.
	Place Line button. Places a straight line on the design (or places a trace, if the active layer is a copper one). Refer to the Placing Shapes and Graphics section of Chapter 4, Working with Parts , and the Placing a Trace: Manual Method section of Chapter 5, Working with Traces and Copper , for more information.
	Follow-me button. Places a follow-me trace. Refer to the Placing a Trace: Follow-me Method section of Chapter 5, Working with Traces and Copper , for more information.

Button	Description
	Place Via button. Places a via on the design. Refer to the <i>Working with Vias</i> section of Chapter 5, <i>Working with Traces and Copper</i> , for more information.
	Place Copper Area button. Places a copper area on the design.
	Create Power Plane button. Places a powerplane on the design. Refer to the <i>Placing Powerplanes</i> section of Chapter 5, <i>Working with Traces and Copper</i> , for more information.
	Design Rule Check button. Runs the Design Rule Check and places results in the Results tab.
	Place Text button. Places text on the design. Refer to the <i>Placing and Editing Text</i> section of Chapter 8, <i>Preparing for Manufacturing/Assembly</i> , for more information.
	Show 3D button. Displays the current design in three dimensions. Refer to the section of Chapter 9, <i>Viewing Designs in 3D</i> , for more information.
	Help button. Displays the helpfile contents page.

Select Toolbar



The **Select** toolbar contains the functions used to control selection filters, and appears by default when you run Ultiboard. Please note that all filters are not available in all versions of Ultiboard. The **Select** toolbar buttons are explained in the table below.



Button	Description
	Enable Selecting Parts button. Use to allow or prevent selection of parts.
	Enable Selecting Traces button. Use to allow or prevent selection of traces.

Button	Description
	Enable Selecting Copper Areas button. Use to allow or prevent selection of copper areas.
	Enable Selecting Vias button. Use to allow or prevent selection of vias.
	Enable Selecting Pads button. Use to allow or prevent selection of pads.
	Enable Selecting SMD Pads button. Use to allow or prevent selection of Surface Mount Device pads.
	Enable Selecting Attributes button. Use to allow or prevent selection of attributes.
	Enable Selecting Other Objects button. Use to allow or prevent selection of other object on the PCB.

Draw Settings Toolbar





The **Draw Settings** toolbar lets you select the layer, thickness and unit of measure of a line or object that is being drawn. It also contains buttons for functions that control the appearance of lines and shapes drawn on any layer, except a copper layer. The **Draw Settings** toolbar elements are explained below.

Button	Description
	Selects the layer for the line or object being drawn.
	Sets the thickness and unit of measure of the line being drawn, or of an object's border. The maximum number of values that can be stored here are set in the Line Width Cache Size field of the General tab of the Preferences dialog box.
	Fill Color button. Sets the color of the layer's fill.

Button	Description
	Fill Style button. Sets the fill style, either transparent or solid.
	Line Color button. Sets the color of the layer's line.
	Line Type button. Sets the lines style, for example, solid, dashed.

Edit Toolbar











The **Edit** toolbar contains the functions used for editing specific elements, including in-place editing and orientation. The **Edit** toolbar buttons are explained in the table below.



Button	Description
	Toggle “In-Place” PCB Part Edit button. Activates In-Place Edit for placed PCB parts. Refer to the Editing a Placed Part (In-Place Edit) section of Chapter 4, Working with Parts , for more information.
	Toggle “In-Place” Edit Text or Attribute button. Allows you to edit the selected text.
	Rotate Clockwise button. Rotates selected item clockwise. Refer to the Orienting Parts section of Chapter 4, Working with Parts , for more information.
	Rotate Counter Clockwise button. Rotates selected item counter-clockwise. Refer to the Orienting Parts section of Chapter 4, Working with Parts , for more information.
	Swap Layer button. Places a part on mirror layer. Refer to the Orienting Parts section of Chapter 4, Working with Parts , for more information.

Align Toolbar

The **Align** toolbar contains the functions used to align and space design elements. Refer to the *Aligning Shapes and Parts* and *Spacing Shapes and Parts* sections of Chapter 4, *Working with Parts*, for more information.







The **Align** toolbar buttons are explained in the table below.









Button	Description
	Align Left button. Aligns the left sides of the selected parts.
	Align Right button. Aligns the right sides of the selected parts.
	Align Top button. Aligns the top edges of the selected parts.
	Align Bottom button. Aligns the bottom edges of the selected parts.
	Align Center Horizontal button. Shifts the selected elements horizontally so their centers are aligned.
	Align Center Vertical button. Shifts the selected elements vertically so their centers are aligned.
	Align to Coordinate button. Displays the Enter coordinate dialog box where you enter new coordinates for the selected element.
	Space Across button. Spaces three or more objects beside each other evenly.
	Space Across Plus button. Increases horizontal space between two or more objects.
	Space Across Min button. Decreases horizontal space between two or more objects.
	Space Down button. Spaces three or more objects above each other evenly.









Button	Description
	Space Down Plus button. Increases vertical space between two or more objects.
	Space Down Min button. Decreases vertical space between two or more objects.



Place Toolbar

The **Place** toolbar contains the functions used to place elements such as traces, lines and polygons on the design. The **Place** toolbar buttons are explained in the table below.

Button	Description
	Place Comment button. Places a comment on the design. Refer to the <i>Placing a Comment</i> section of Chapter 8, <i>Preparing for Manufacturing/Assembly</i> , for more information.
	Capture Area button. Captures a section of the screen and places it on the system clipboard.
	Select button. De-activates any selected mode (for example, for placing traces) and allows you to select an element on the board.
	Place Line button. Places a line on the design (or place a trace, when used on a copper layer). Refer to the <i>Placing Shapes and Graphics</i> section of Chapter 4, <i>Working with Parts</i> , for more information.
	Place Arc button. Places an arc on the design. Refer to the <i>Placing Shapes and Graphics</i> of Chapter 4, <i>Working with Parts</i> , section for more information.
	Place Bezier button. Places a bezier curve on the design. Refer to the <i>Placing Shapes and Graphics</i> section of Chapter 4, <i>Working with Parts</i> , for more information.
	Place Circle button. Places a circle on the design. Refer to the <i>Placing Shapes and Graphics</i> section of Chapter 4, <i>Working with Parts</i> , for more information.



Button	Description
	Place Ellipse button. Places an ellipse on the design. Refer to the <i>Placing Shapes and Graphics</i> section of Chapter 4, <i>Working with Parts</i> , for more information.
	Place Pie button. Places a pie-shape on the design. Refer to the <i>Placing Shapes and Graphics</i> section of Chapter 4, <i>Working with Parts</i> , for more information.
	Place Rounded Rectangle button. Places a rectangle with rounded corners. Refer to the <i>Placing Shapes and Graphics</i> section of Chapter 4, <i>Working with Parts</i> , for more information.
	Place Rectangle button. Places a rectangle on the design. Refer to the <i>Placing Shapes and Graphics</i> section of Chapter 4, <i>Working with Parts</i> , for more information.
	Place Polygon button. Places a polygon on the design. Refer to the <i>Placing Shapes and Graphics</i> section of Chapter 4, <i>Working with Parts</i> , for more information.
	Place Copper Area button. Places a polygon copper area on the design. Refer to the <i>Placing Copper Areas</i> section of Chapter 5, <i>Working with Traces and Copper</i> , for more information.
	Follow-me button. Places a follow me trace, a trace that automatically draws a legal trace between two selected points. Refer to the <i>Placing a Trace: Follow-me Method</i> section of Chapter 5, <i>Working with Traces and Copper</i> , for more information.
	Place Multiple Traces as a Bus button. Use to connect multiple traces between multi-pinned devices such as ICs. Refer to the <i>Placing a Bus</i> section of Chapter 5, <i>Working with Traces and Copper</i> , for more information.
	Place Group Array Box button. A group array box is used to place parts in an array. Refer to the <i>Placing a Group Array Box</i> section of Chapter 4, <i>Working with Parts</i> , for more information.

Button	Description
	Place Text button. Places text on the design. Useful for annotation purposes. Refer to the <i>Placing and Editing Text</i> section of Chapter 8, <i>Preparing for Manufacturing/Assembly</i> , for more information.
	Place a Standard Dimension button. Places a dimension between any two selected points. Refer to the <i>Working with Dimensions</i> section of Chapter 4, <i>Working with Parts</i> , for more information.
	Place a Horizontal Dimension button. Places a horizontally-oriented dimension between two selected points. Refer to the <i>Working with Dimensions</i> section of Chapter 4, <i>Working with Parts</i> , for more information.
	Place a Vertical Dimension button. Places a vertically-oriented dimension between two selected points. Refer to the <i>Working with Dimensions</i> section of Chapter 4, <i>Working with Parts</i> , for more information.
	Place a Net Bridge button. Places a net bridge connection. Refer to the <i>Net Bridges</i> section of Chapter 5, <i>Working with Traces and Copper</i> , for more information.
	Place a Hole button. Places a hole on your PCB.
	Place a Via button. Places a via on the design. Refer to the <i>Working with Vias</i> section of Chapter 5, <i>Working with Traces and Copper</i> , for information.
	Place Pins button. Places pins on the design when editing or creating a part in In-place Edit mode or Footprint Edit mode. Refer to the <i>Editing a Placed Part (In-Place Edit)</i> and <i>Using the Database Manager to Create a Part</i> sections of Chapter 4, <i>Working with Parts</i> , for more information.

Button	Description
	Polygon Splitter button. Splits copper areas and powerplanes. Refer to the <i>Splitting Copper</i> section of Chapter 5, <i>Working with Traces and Copper</i> , for more information.
	Remove Copper Islands button. Removes copper islands. Refer to the <i>Placing Copper Areas</i> section of Chapter 5, <i>Working with Traces and Copper</i> , for more information.



Wizard Toolbar



The **Wizard** toolbar contains the wizard functions supported by Ultiboard. The **Wizard** toolbar buttons are explained in the table below.

Button	Description
	Board Wizard button. Starts the Board Wizard. Refer to the <i>Working with the Board Outline</i> section of Chapter 3, <i>Setting Up a Design</i> , for more information.
	Part Wizard button. Starts the Part Wizard . Refer to the <i>Using the Part Wizard to Create a Part</i> section of Chapter 4, <i>Working with Parts</i> , for more information.

Autoroute Toolbar

The **Autoroute** toolbar contains the autorouting and placement functions supported by Ultiboard. The **Autoroute** toolbar buttons are explained in the table below.

Button	Description
	Begin Autoplacing button. Starts automatically placing parts.
	Autoroute Selected Buses button. Displays the Bus Autorouting dialog.
	Start Trace Optimization button. Starts trace optimization.

Button	Description
	Start/Resume Autorouting button. Starts automatically placing traces.
	Stop/Pause Autorouter button.

Setting Preferences

This section explains general procedures for setting preferences. The following sections describe details of setting specific options.

Complete the following steps to set your user preferences:

1. Choose **Options»Global Preferences**. The **Preferences** dialog box appears, offering you the following tabs:
 - *General Tab*
 - *Paths Tab*
 - *Colors Tab*
 - *PCB Design Tab*
 - *Dimensions Tab*
 - *3D Options Tab*
2. Select the desired tab.
3. Set the desired customization options. The specific options and settings available in the tabs are described in the following sections.
4. Click **OK** to save your changes.

General Tab



Complete the following steps to change workspace options:

1. Choose **Options»Global Preferences** and select the **General** tab.
2. Set the **Fullscreen mode**, **View**, **Crosshair** and **Mouse wheel behavior** settings as desired.
3. Set the following as desired:
 - **Auto save settings**—Enable to have changes automatically saved (at the specified **Time interval**).
 - **Minimum control point size**—The size of the control points on vertices and other objects.

- **Line width cache size**—The number of recently used line widths Ultiboard keeps in memory. Minimum cache size is 5.
 - **Undo buffer size**—The number of undo actions allowed.
 - **Load last file on startup**—Enable if you would like to continue working on the last file you had open in your previous Ultiboard session.
 - **Unicode Settings box**—If desired, enable the **Save .TXT files as plain text** checkbox.
 - **Language**—Select the desired language from the list. You must restart Ultiboard for all dialog boxes to reflect the new setting.
4. To apply your changes but leave the **Preferences** dialog box open, click **Apply**. To apply your changes and close the **Preferences** dialog box, click **OK**.

Paths Tab

The Ultiboard installation puts specific files in specific locations. If necessary you can point Ultiboard to a new location to find, for example, database files. You can also use this dialog box to create and specify user settings files that contain individuals' preferences for all options.

Complete the following steps to change file locations:



1. Choose **Options»Global Preferences**. The **Preferences** dialog box appears.
2. Select the **Paths** tab.
3. Change the following as desired:
 - **Circuit Default Path**—This is where all new files are saved, unless you manually navigate to a new location when saving.
 - **User Button Images Path**—This is where you store any user-created button graphics.
4. Change the **User Settings** as desired:
 - **Configuration File**—Contains the user interface settings.
 - **New User Configuration File**—Click to create a new user configuration file and select an item from the drop-down list.
5. Change the settings in the **Database Files** area as desired:
 - **Master Database**—The location of the **Master Database**.
 - **Corporate Database**—The location of the **Corporate Database**.
 - **User Database**—The location of the **User Database**.

Colors Tab

Ultiboard allows you to set up color schemes for the workspace background and other displayed elements.

Complete the following steps to set up color schemes:



1. Choose **Options»Global Preferences**. The **Preferences** dialog box appears.
2. Select the **Colors** tab and complete the following as required:
 - To apply an existing color scheme, either the default or one you have created, choose from the **Color scheme** drop-down list.
 - To modify an existing color scheme, choose it from the **Color scheme** drop-down list. From the **Color element** drop-down list, choose the element whose color you want to modify. Click the color button (unlabelled) and choose a new color for that element. Your change is stored with the color scheme when you click **Apply** or **OK**.
 - To create a color scheme, click **New scheme** and provide a scheme name. The element colors remain at the value they had in the most recently loaded scheme. Modify the element colors as described above, and save your changes by clicking **Apply** or **OK**.
 - To add a color element, click **New element** and enter a name. The element appears in the **Color element** list, and you can choose a color for the element.
 - Optionally, enable the **Preview grayed out** checkbox to switch the preview visibility on or off and adjust and select the **Grayed out factor**.

Your changes are reflected in the **Preview** area.

3. To apply your changes but leave the **Preferences** dialog box open, click **Apply**. To apply your changes and close the **Preferences** dialog box, click **OK**.

PCB Design Tab

Use the **PCB Design** tab of the **Preferences** dialog box to define a variety of actions associated with the overall PCB design.

Complete the following steps to define the default actions:



1. Choose **Options»Global Preferences**. The **Preferences** dialog box appears.
2. Select the **PCB Design** tab.

3. Set the viewing options in the **View** area:
 - **Show pin 1 mark**—Enable to display pin 1 of a device with a unique marking.
 - **Show Copper Areas**—Enable to display copper areas. This applies to copper areas only, not regular polygon shapes on non-copper layers.
 - **Show pin info in pin**—Enable to display the pin number and hole size when zoomed in.
4. In the **On select entire trace** area:
 - **Select Across Layers**—Enable so that when you choose **Edit>Select Entire Trace**, the trace will be selected across all layers, instead of just the active layer.
5. In the **Part Drag** area:
 - **Re-route after move**—Enable if you would like the traces that are attached to a part to be re-routed if you move the part.
6. In the **Default pin diameters** area:
 - **Units**—Select unit of measurement from drop-down list.
 - **Jumpers**—Enter the default pin diameter for jumpers.
 - **Testpoints**—Enter the default pin diameter for testpoints.
7. In the **Action on DRC error** area, set the actions to be taken when Ultiboard encounters a Design Rule Error:
 - **Cancel the current action**—Enable to prevent the current operation from being completed. For example, placing a trace over a pad that is part of a different netlist will not be permitted.
 - **Ask for Confirmation**—Enable so that if an invalid operation is attempted a prompt is given asking if the operation should be completed even though a Design Rule will be violated.
 - **Overrule**—Enable to permit the operation to be completed.
8. In the **On trace deletion** area:
 - **Auto delete Via (standard)**—Enable to have vias automatically deleted when you delete the trace associated with that via.
 - **Auto delete teardrop**—Enable to have teardrops automatically deleted when you delete the trace associated with that teardrop.

9. In the **On trace placement** area:
 - **Auto trace narrowing**—Enable to allow traces to narrow as necessary during routing.
 - **Auto add teardrop**—Enable to add a teardrop when a trace is placed.
10. In the **DRC & Net check** area:
 - **No Realtime Check**—Enable to prevent a DRC and netcheck in “real time” as you place objects, for example, parts.
 - **Check on action end**—Enable to perform a DRC and netcheck after each action, for example, part placement.
 - **Full Realtime Check**—Enable to perform DRC checks and ratnest updates to your work in “real time” (as you place objects, for example, parts).
11. In the **Follow me router** area:
 - **Continuous place**—Enable to have the next trace begin from the finish point of the previous trace when placing a “Follow-me” trace. If this is not selected, you must click to start a new trace.

Refer to the [Placing a Trace: Follow-me Method](#) section in Chapter 5, [Working with Traces and Copper](#), for information about Follow-me traces.
12. In the **Crosshair** area:
 - **Trace snap**—Enable to have the pointer snap to the nearest trace.

Refer to the [Working with Traces](#) section in Chapter 5, [Working with Traces and Copper](#), for information about using trace snap.
13. In the **Post processing** area:
 - **Show fiducial marks**—Enable to show fiducial marks when you postprocess this design. Fiducial marks are used to align layers with each other. As shown in the figure below, Ultiboard uses three different types of cocentric circles as fiducial marks. These are placed on three of the four corners of a design when it is printed or exported to Gerber.

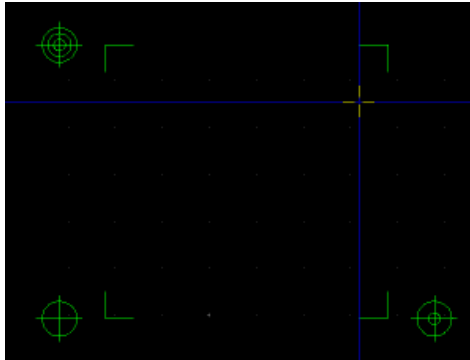

14. To apply your changes but leave the **Preferences** dialog box open, click **Apply**. To apply your changes and close the **Preferences** dialog box, click **OK**.

Dimensions Tab

Use the **Dimensions** tab of the **Preferences** dialog box to define the characteristics to be used for any dimensions placed in the board. Refer to the [Working with Dimensions](#) section of Chapter 4, [Working with Parts](#), for information about placing dimensions.

Complete the following steps to define the default dimension characteristics:



1. Choose **Options»Global Preferences**. The **Preferences** dialog box appears.
2. Click the **Dimensions** tab.
3. Set the following as desired:
 - **Units**—This is the unit of measure for **Stub Length**, **Arrow Style** and **Text Style**.
 - **Stub Length**—This is the amount the end lines of the dimension protrude above each arrowhead.
 - **Arrow Style**—This is where you adjust the size and appearance of the arrow.
 - **Text Style**—This is where you adjust the size and appearance of the text.

- **Displayed Unit**—Select the unit of measure to be displayed with the dimension. If you select **Use Design Settings**, the unit of measure selected in the **Design Units** field of the **Grids & Units** tab of the **PCB Properties** dialog box are used. This setting also appears in the **Draw Settings** toolbar.
- **Alignment** and **Position**—These are where you set how the text appears in relation to the arrow.
- **Orientation**—This is where you select the angle at which the dimension displays.

The results of your choices are previewed on the tab.

4. To apply your changes without closing the dialog box, click **Apply**. Existing dimensions are not affected. To apply your changes and close the dialog box, click **OK**.

3D Options Tab



Complete the following steps to set 3D viewer options:

1. Choose **Options»Global Preferences** and select the **3D Options** tab.
2. To change the background color in the 3D viewer, click on the shaded rectangle beside **Background color**. The **Color** dialog box appears.
3. Select the desired color and click **OK** in the **Color** dialog box.
4. Optionally, enable the **Show Copper and Silkscreen while moving** checkbox.
5. Set the **Internal View Options** as desired.



Tip The more space that you set between the layers, the easier they will be to view when you zoom in on the PCB in the 3D mode. Refer to the [Internal View](#) section of Chapter 9, [Viewing Designs in 3D](#), for more information.

6. To apply your changes but leave the **Preferences** dialog box open, click **Apply**. To apply your changes and close the **Preferences** dialog box, click **OK**.

Setting PCB Properties

Many characteristics of your PCB design are controlled through the **PCB Properties** dialog box including the number of layers, design rules and grid settings. These settings are saved with the design and will be in effect when the design is reopened.

Do one of the following to display the **PCB Properties** dialog box for the board:



- With nothing selected on the board, right-click on an empty portion of the board and choose **Properties** from the context menu that appears.
- Click on an empty portion of the board and choose **Edit»Properties**.
- Double-click on an empty portion of the board.

Attributes Tab

All properties dialog boxes for all design elements have an **Attributes** tab, although a design's PCB typically does not have any attributes. Refer to the [Attributes](#) section of Chapter 4, *Working with Parts*, for information about adding attributes.

Grid & Units Tab

Use the **Grid & Units** tab of the **PCB Properties** dialog box to control Ultiboard grids and set the unit of measurement for your design.

Complete the following steps to set up the grid properties:

1. Choose the default units of measure from the **Design Units** list.
2. In the **Grid** area, set the following elements as desired:
 - **Grid Type**—Select **Standard Grid** for a rectangular grid, or **Polar Grid**, for a circular grid.
 - **Visible grid style**—This is where you set the style for the **Visible Grid**. (The **Visible Grid** provides a visual reference for you to visually align parts and traces).
 - **Visible grid**—This is the distance between the grid's elements (dots, lines or crosses) that you set up in the **Visible grid style** field.
 - **Grid Step Name**—Use this field to change the distance between a grid's elements. Select the desired grid: **Part Grid**; **Copper Grid**; **Via Grid**; **SMD Grid**, and then enter the desired increment in the **Grid Step Value** field.

- **Degree Step**—This field becomes active when **Polar Grid** is selected in the **Grid Type** field. Enter the desired distance between the grid's elements (dots, lines or crosses). Select the unit of measure in the drop-down list to the right of this field—choices are: degrees, radians, or grads.
 - **Grid start offset**—This field becomes active when **Polar Grid** is selected in the **Grid Type** field. Enter the distance to offset the center of the polar grid: **X** is horizontal offset; **Y** is vertical offset.
3. Click **OK** to close the dialog.



To show or hide the visible grid, select **View»Grid**.

Copper Layers Tab

Use the **Copper Layers** tab of the **PCB Properties** dialog box to determine the layer pairs that are acceptable for blind, buried or micro vias. This is used when you try to place a via. Your choices will affect the cost of the board, and should be confirmed with the board manufacturer.

This tab also allows you to set the default clearance for the board—the distance from the edge of the board that is to be kept free of any other elements. For example, if you try to run a trace through a clearance, or try to place a part so that a pad is put within a clearance, a design rule error occurs.



Note If you used the **Board Wizard**, the layer information and clearance may already have been set. Refer to the *Using the Board Wizard* section of Chapter 3, *Setting Up a Design*, for more information.

Complete the following steps to set up the **Copper Layers** tab:

1. Set the number of layer pairs you intend to use by entering the value or using the up/down arrows in the **Layer Pairs** field. There should be at least one layered pair to act as a core.
2. Set the number of **Single Layer Build-ups** for both the top and bottom. There should be at least one layered pair to act as a core.
3. Select the **Micro Vias**, **Buried Vias**, or **Blind Vias** checkboxes to use these in your design.

- As you make changes to the layer settings, the **Allowed Vias** pane shows the acceptable layer combinations for blind and buried vias or microvias. Use the checkboxes to select the layer combinations you want to allow in your design as shown in the example in the figure below.

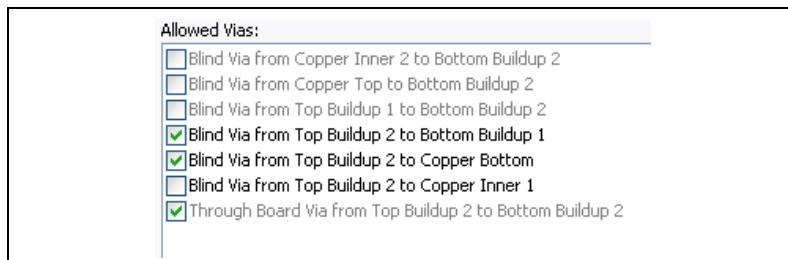

- In the **Allow Routing** area, from the **Copper Layer** drop-down list, select the copper layer for which you wish to assign routing properties and click **Properties** to display the **Copper Layer Properties** dialog box.
 Enable the **Routable** checkbox to allow routing on the selected layer. In the **Trace Bias** drop-down list, select one of **Horizontal**; **Vertical**; or **None**.
 Click **OK** to close the **Copper Layer Properties** dialog box.
- In the **Board** area, enter the desired **Board Outline Clearance** and **Board Thickness**.
- Click **OK** to close the dialog box.

Pads/Vias Tab

Use the **Pads/Vias** tab of the **PCB Properties** dialog box to set the following:

- Through Hole Pad Annular Ring*
- Vias*
- Microvias*
- Maximum Vias Per Net*
- Surface Mount Pads Oversize*

Through Hole Pad Annular Ring

Footprints in the database have been designed with pad sizes in accordance with the manufacturers' recommendations. To change these settings you can edit the footprint in the database or directly on the design using the **In-place Part Edit** command. Alternatively, you can apply a set of design rules to specific footprints or to the entire design.

The annular ring setting (the ring of copper around the drill hole of a pad or via) allows you to specify either a fixed value (for example, 50 mils) or a relative value that depends on the radius of the drill hole size. For example, a 50 mil drill hole (radius of 25 mils) with a relative value of .6 (60%) will create an annular ring of 15 mils (60% of 25 mils). When using relative settings, it is important to choose minimum and maximum values to ensure that the annular ring will never go beyond those bounds.

Complete the following to enter an annular ring setting:

1. Click the button beside the desired field (**Top**, **Inner** or **Bottom**) in the **Pad/Vias** tab. The **Through Hole Pad Properties** dialog box appears.

Choose **Fixed** and enter the fixed value.

Or

Choose **Relative** and enter the relative setting. Be sure to choose **Min** and **Max** values.

Complete the following to apply the design rules to a footprint:

1. Select the footprint and choose **Edit»In-Place Part Edit**.
2. Select the pads to which the rule should apply.
3. Right-click and, from the context menu, choose **Properties**.
4. On the **Pad** tab of the properties dialog box, enable **Use Design Rules**.

Vias

The **Vias** setting sets the default **Drill Diameter** and **Pad Diameter** to be used when a via is placed during trace placement. This setting also applies to vias that have already been placed in the design.

Microvias

The **Micro Vias** area is where you set the default via dimensions to be used when a microvia is placed during trace placement. This setting will also apply to microvias that have already been placed in the design.

The **Capture Land Diameter** field determines the land diameter where the microvia starts, while **Target Land Diameter** determines the diameter where the microvia ends. These terms are in accordance with the IPC and JPCA joint standard IPC/JPCA-2315, Design Guide for High Density Interconnects (HDI) and Microvias. The **Maximum Layer Span** is either one or two layers.

Maximum Vias Per Net

The **Nets** area is where you set up the maximum number of vias allowed per net.

Surface Mount Pads Oversize

Depending on the manufacturing process you are using, you may wish to enlarge the size of all surface mount pads by a fixed amount. This can be set independently for the **Top** and **Bottom** layers. The setting refers to the amount that will be added to the pad. In the case of a circular pad this amount is added to the radius. In the case of a rectangular or square pad the amount will be added to the width and length.

General Layers Tab

Use the **General Layers** tab of the **PCB Properties** dialog box to control which layers are available on the board.

Complete the following steps to control the numbers of layers in the board:

1. Add layers to the board by selecting the checkbox beside the layer name.
2. Remove layers from the board by clearing the checkbox beside the layer name.



Note You can have a layer available on the board, and temporarily dim or hide it. Refer to the [Accessing Layers](#) section of Chapter 3, [Setting Up a Design](#), for more information.



Note There are up to ten mechanical CAD layers in PCB design. These layers allow you to provide information that is directly related to the PCB. You place elements on them to represent the mechanical elements of your design – for example, cabinet casing or mounting brackets.

Complete the following steps to rename layers:

1. Click **Rename** in the **Layer Names** area. The **Select Layer for Renaming** dialog box appears.
2. Select the layer that you wish to rename and click **OK**. The **Layer** dialog box appears.
3. Enter the new **Layer Name** and click **OK**.

Design Rules Tab

Complete the following steps to set the design rules for the PCB:

1. Click on the **Design Rules** tab.
2. In the **Design Rule Default Values** area, set the following as desired:
 - **Trace Width Settings**—Set trace width and minimum and maximum trace width.
 - **Trace Length Settings**—Set minimum and maximum trace length.
 - **Trace Neck Settings**—Set minimum and maximum trace neck length.
 - **Clearance Settings**—Set clearance to traces, pads, vias and copper areas. For all of these clearances to be active, and display in the **Spreadsheet View**, the **Use multiple clearances** checkbox must be selected. Otherwise, only clearance to traces will be operational.
 - **Part Spacing Settings**—Set minimum distance between parts. This setting only applies to the spacing during part shoving.



Tip To set this option for an individual part, go to the **Part** tab of that part's properties dialog box. Refer to the [Shoving Parts](#) section of Chapter 4, [Working with Parts](#), for more information.

- **Pin & Gate Swapping Settings**—Set parameters for pin and gate swapping.
- **Thermal Relief**—Set the thermal relief shape.
- **Drill Technology**—Set the minimum tool size for slot drilling.

For information on any setting, select it in the **Design Rule Default Values** area. A description appears in the field at the bottom of the dialog.

Setting Favorite Layers

You can assign shortcuts for up to ten layers using the **Favorite layers** tab. These shortcuts can then be used to make a layer active. The active layer is the layer where any new elements will be placed, or where any deletions will be made.

Complete the following steps to assign shortcut numbers to layers:

1. Click on the **Favorite layers** tab.
2. Select the desired layer from the drop-down list beside each layer number. For example, you may wish to assign **Layer 2** to the **Copper Bottom** layer.
3. Click **OK**.

To make a layer active, press <Ctrl-Alt-layer number> on your keyboard. The layer becomes active and is highlighted in the **Layers** tab of the **Design Toolbox**.

In the above example, pressing <Ctrl-Alt-2> on your keyboard makes the **Copper Bottom** layer active.

Design Toolbox

The **Design Toolbox**, shown in the figure below, is a vital part of the user interface. You will use it often to manage your design efforts by controlling major parts of Ultiboard's functionality. To toggle it on or off, select **View»Design Toolbox**.

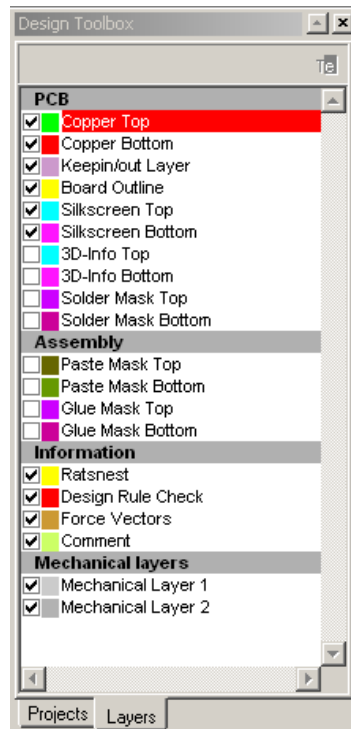

The **Design Toolbox** is made up of two tabs:

- The **Projects** tab lets you view the projects that are currently open. Each project may contain one or more designs. Double-click to make a particular design the current view.
- The **Layers** tab lets you move between layers of your design, control the appearance of layers, and perform several other functions.

Birds Eye View

The **Birds Eye View** shows you the design at a glance and lets you easily navigate around the workspace.

To magnify a specific area on the design, drag a rectangle around the desired area on the **Birds Eye View**. The rectangle snaps to the same ratio as the design space.



Note All layers appear in the **Birds Eye View**, whether or not they have been disabled in the **Layers** tab of the **Design Toolbox**.

In the example in the figure below, the green rectangle that was drawn encloses the four ICs in the middle of the **Birds Eye View**, and the design has magnified to display only the items that are selected within this rectangle.

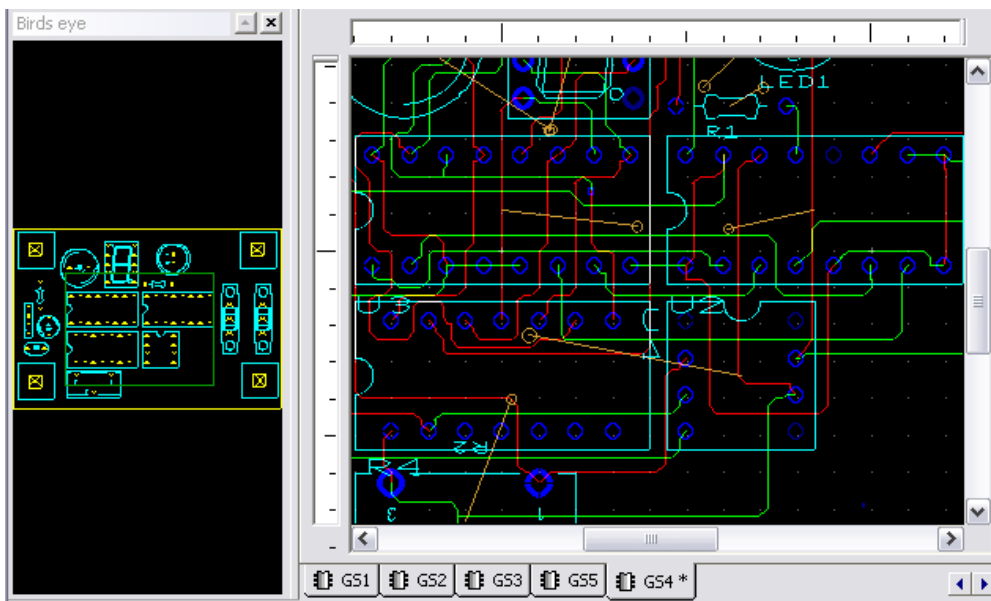

To move the rectangle, hold down the right mouse button anywhere over the **Birds Eye View**, and drag the rectangle to the desired location.



Tip You cannot resize the selection rectangle in the **Birds Eye View**. Instead, you must draw another rectangle of the required size. When you do this, the original rectangle disappears.

Spreadsheet View

The **Spreadsheet View** allows fast advanced viewing and editing of parameters including part details such as footprints, Reference Designators, attributes and design constraints.















By default, the **Spreadsheet View** does not appear until you have opened a project. To toggle the **Spreadsheet View** on and off, select **View»Spreadsheet View**.

The following buttons are available in the **Spreadsheet View**.



Note The buttons do not appear in all tabs.

Button	Description
	Export to Textfile button. Displays a standard Windows Save dialog where you save the selection as a textfile.
	Export to CSV File button. Displays a standard Windows Save dialog where you save the selection as a file with comma-separated values.
	Export to Excel button. Click to open a Microsoft® Excel spreadsheet with the selected data displayed. (You must have Excel installed to use this function).
	Sort Ascending button. Sorts the selected column in ascending order.
	Sort Descending button. Sorts the selected column in descending order.
	Print button. Prints the data in the selected tab.
	Select All button. Selects all elements in the tab.
	Copy button. Copies the selection to the clipboard.

Button	Description
	<p>Find and Select the Part button. Zooms in on the selected part. Refer to the <i>Using the Parts Tab for Other Functions</i> section of Chapter 4, <i>Working with Parts</i>, for more information.</p>
	<p>Lock the Selected Part button. Locks the selected unlocked parts or unlocks the selected locked parts. Refer to the <i>Using the Parts Tab for Other Functions</i> section of Chapter 4, <i>Working with Parts</i>, for more information.</p>
	<p>Start Placing the Unpositioned Parts button. Refer to the <i>Using the Parts Tab to Place Parts</i> section of Chapter 4, <i>Working with Parts</i>, for more information.</p>
	<p>Show preview button. Toggles the Spreadsheet View's Preview function on and off. Refer to the <i>Using the Parts Tab for Other Functions</i> section of Chapter 4, <i>Working with Parts</i>, for more information.</p>



Note You can also access the above commands from a pop-up menu by right-clicking in the **Spreadsheet View**.

Spreadsheet View: DRC Tab

The **DRC** tab displays errors (for example, **Design Rule Errors**) and warnings as they occur while you work. Errors are labeled with red triangles, and warnings are labeled with yellow circles, as shown in the example in the figure below.

Double-click on an error or warning to go to its location on the workspace.

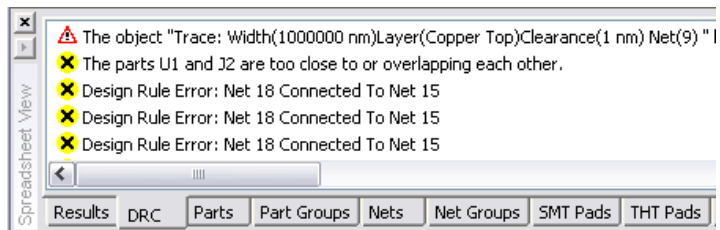

When you right-click on an item in the **DRC** tab, a pop-up menu displays with the following available selections:

- **Copy**—Copies all items in the **DRC** tab and places them on the clipboard.
- **Go to Error/Tag**—Click to go to the highlighted error or warning on the workspace.
- **Add to Filter**—Click to filter out the selected error/warning type. This type of error/warning will no longer show in the **DRC** tab.
- **Remove all filters**—Click to remove all error/warning types from the filter. All errors and warnings will now show in the **DRC** tab.
- **Start Filter Manager**—Click to start the **Filter Manager**. Refer to the *Filter Manager* section for more information.

Filter Manager

Use the **Filter Manager** to filter desired errors & warnings out of the **DRC** tab in the **Spreadsheet View**.

Complete the following steps to use the **Filter Manager**:

1. Right-click in the **DRC** tab of the **Spreadsheet View** and select **Start filter manager** from the pop-up that appears.
The **Filter Manager** dialog box appears with a list of errors and warnings that are filtered out of the **DRC** tab. If this is the first time you are accessing this dialog box, it will be empty.
2. Click **Add Filter** to display the **Add Filter(s)** dialog box.

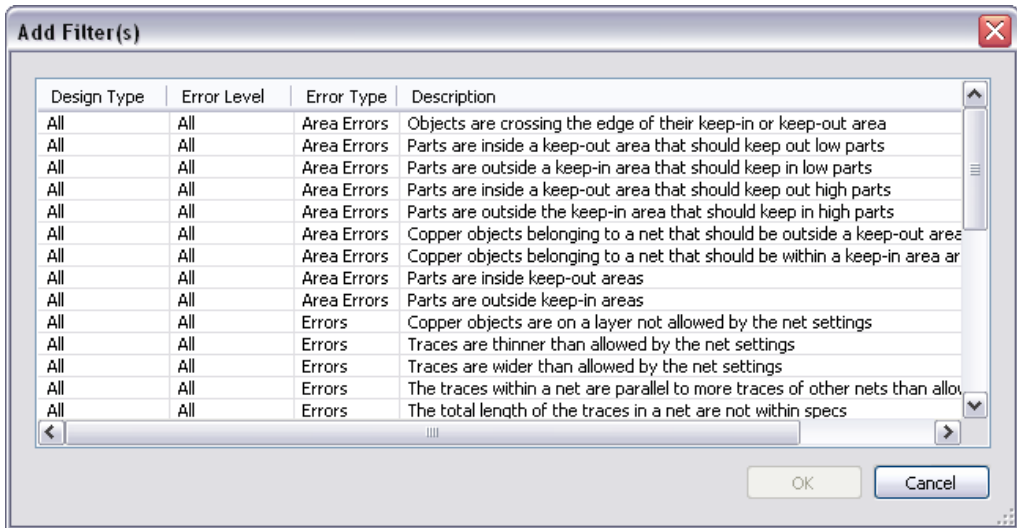

3. Select the error type(s) to add to the filter. You can use the Ctrl and Shift keys to select multiple items.
4. Click **OK** to close the **Add Filter(s)** dialog box and add the selected items to the **Filter Manager**.
5. Click **Close** to close the **Filter Manager** dialog box. The selected error types no longer display in the **DRC** tab.

To remove an error type from the **Filter Manager**, select the error type and click **Remove Filter**.

To remove all error types, click **Remove All**.

Spreadsheet View: Results Tab

The **Results** tab displays the results of searching for elements in the design. Refer to the [Searching for Design Elements](#) section of Chapter 2, [Beginning a Design](#), for more information.

It also displays the results of running a connectivity check. Refer to the [Design»Connectivity Check](#) section of Appendix A, [Menus and Commands](#), for more information.



Note The **Results** tab flashes red when it contains new data.

Double-click a line in this tab to zoom in on the corresponding area of the design.

You can also right-click an item to display a popup that contains **Copy**; **Clear Results**; **Go to**.

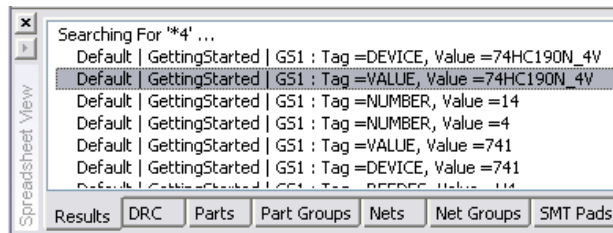

Spreadsheet View: Parts Tab

Use the **Parts** tab to work with the parts in your design. Refer to the [Using the Parts Tab in the Spreadsheet View](#) section of Chapter 4, [Working with Parts](#), for more information.

Column	Description
(unlabelled)	The colored circle indicates whether the part has been placed on the board outline (bright green), or is off to the side awaiting placement (dark green). Orange indicates the part has been locked.
RefDes	The part's Reference Designator (unique identifier).
Value	The part's value, for example, 150 pF for a capacitor.
Shape	The physical footprint of the part.
Locked	Yes indicates that the part cannot be moved. No indicates that the part can be moved.
Trace Clearance	This is the minimum spacing allowed between the part and any trace. You can enter a value here, or use the Group Editor . Refer to the Working with the Group Editor section of Chapter 3, Setting Up a Design , for more information.
Part Spacing	This is the minimum spacing allowed between parts. You can enter a value here, or use the Group Editor . Refer to the Working with the Group Editor section of Chapter 3, Setting Up a Design , for more information.

Column	Description
Pin Swap	If enabled, allows like-pins to be swapped during the routing process. You can choose either No (not enabled), Yes or Use Group Settings . Refer to the Working with the Group Editor section of Chapter 3, Setting Up a Design , for more information.
Gate Swap	If enabled, allows like-gates, to be swapped during the routing process. You can choose Internal Gates Only , which will swap gates within the same IC; No Swapping ; Advanced Swapping , which will swap gates between ICs (both devices must be set to Advanced Swapping); or Use Group Settings . Refer to the Working with the Group Editor section of Chapter 3, Setting Up a Design , for more information.
Part Group	The group in which the part is placed. You can select No Group or an existing group from the drop-down list. Parts groups are created in the Group Editor . Refer to the Working with the Group Editor section of Chapter 3, Setting Up a Design , for more information.

Spreadsheet View: Part Groups Tab

Use the **Part Groups** tab to work with part groups as described in the table below.

Column	Description
Part Group	This is the group in which the part is contained. Refer to the Working with the Group Editor section of Chapter 3, Setting Up a Design , for more information.
Trace Clearance	This is the minimum spacing allowed between the parts in the group and any trace. You can enter a value here, or use the Group Editor . Refer to the Working with the Group Editor of Chapter 3, Setting Up a Design , section for more information.
Part Spacing	This is the minimum spacing allowed between parts in the group. You can enter a value here, or use the Group Editor . Refer to the Working with the Group Editor of Chapter 3, Setting Up a Design , section for more information.

Column	Description
Pin Swap	If enabled, allows pins for like-parts to be swapped during the routing process.
Gate Swap	If enabled, allows like-gates, to be swapped during the routing process. You can choose Internal Gates Only , which will swap gates within the same IC; No Swapping ; or Advanced Swapping , which will swap gates between ICs (both devices must be set to Advanced Swapping).
Locked	Yes indicates that the part cannot be moved. No indicates that the part can be moved.

Spreadsheet View: Nets Tab

Use the **Nets** tab to work with the net lists in your design. Refer to the [Using the Nets Tab](#) section for more information.

Column	Description
(unlabelled)	The colored circle indicates whether the copper for the net has been routed, that is, placed on the board outline (bright green), or is awaiting placement (dark green). Orange indicates the copper for the net has been locked. You cannot lock the net until it has been routed.
Net Name	The net's unique identifier.
Locked	Yes indicates that the net cannot be moved. No indicates that the net can be moved. You cannot lock a net until it has been routed.
Trace Width	The "default" width of the trace that is placed during routing. You can enter a value here, or use the Group Editor . Refer to the Working with the Group Editor of Chapter 3, Setting Up a Design , section for more information.
Max Width	The maximum width to which a trace will be laid during routing. You can enter a value here, or use the Group Editor . Refer to the Working with the Group Editor of Chapter 3, Setting Up a Design , section for more information.

Column	Description
Min Width	The minimum width to which a trace will be laid during routing. You can enter a value here, or use the Group Editor. Refer to the <i>Working with the Group Editor</i> of Chapter 3, <i>Setting Up a Design</i> , section for more information.
Topology	The topology of the net as set in the Netlist Editor . Choices are Shortest , Daisy Chain and Star . Refer to the <i>Using the Netlist Editor</i> section of Chapter 5, <i>Working with Traces and Copper</i> , for more information. This feature is not available in all versions of Ultiboard.
Trace Length	Length of the routed net.
Max Length	Maximum allowable length of copper in a net. Not applicable (N/A) if Topology is set to Shortest .
Min Length	Minimum allowable length of copper in a net. Not applicable (N/A) if Topology is set to Shortest .
Trace Clearance	This is the minimum spacing allowed between the parts in the group and any trace. You can enter a value here, or use the Group Editor . Refer to the <i>Working with the Group Editor</i> section of Chapter 3, <i>Setting Up a Design</i> , for more information.
Routing Layers	The routing layers assigned to this net group. Click to display the Layers to Apply dialog box, where you set the layers to use for routing copper.
Routing Priority	The routing priority for the selected net. 1 is the highest priority, 2 the second highest, etc. Leave as None if priority routing is not required. This feature is not available in all versions of Ultiboard.
Net Group	This is the group in which the net is contained. You can either enter the group name here, or use the Group Editor . Refer to the <i>Working with the Group Editor</i> section of Chapter 3, <i>Setting Up a Design</i> , for more information.

Column	Description
Bus Group	This is the bus group in which the net is contained. You can either enter the group name here, or use the Group Editor . Refer to the <i>Working with the Group Editor</i> section of Chapter 3, <i>Setting Up a Design</i> , for more information.
Differential Pair	This is the differential pair to which the net belongs. Refer to the <i>Working with the Group Editor</i> section of Chapter 3, <i>Setting Up a Design</i> , for more information.
Shield Net	Use the drop-down list to select the net to use to shield this net. This feature is not available in all versions of Ultiboard.
Shield Width	Width of the net's shield. This feature is not available in all versions of Ultiboard.
Show Ratsnest	This is where you can show or hide the ratsnest for the selected net. Refer to the <i>Working with Ratsnests</i> section of Chapter 4, <i>Working with Parts</i> , for more information.
Max Via Count	This is the maximum number of vias allowed for the selected net. You can use either the global settings, or the group settings.
Via Drill Diameter	This is the diameter of the via pad's hole.
Via Pad Diameter	This is the diameter of the total via pad.

Spreadsheet View: Nets Groups Tab

Use the **Net Groups** tab to work with net groups.

Column	Description
Net Group	This is the group in which the net is contained. You can either enter the group name here, or use the Group Editor. Refer to the Working with the Group Editor section of Chapter 3, Setting Up a Design , for more information.
Trace Width	The “default” width of the traces in the group that are placed during routing. You can enter a value here, or use the Group Editor. Refer to the Working with the Group Editor of Chapter 3, Setting Up a Design , section for more information.
Max Width	The maximum width to which a trace in the group will be laid during routing. You can enter a value here, or use the Group Editor . Refer to the Working with the Group Editor of Chapter 3, Setting Up a Design , section for more information.
Min Width	The minimum width to which a trace in the group will be laid during routing. You can enter a value here, or use the Group Editor . Refer to the Working with the Group Editor section of Chapter 3, Setting Up a Design , for more information.
Max Length	Maximum allowable length of copper in a net group. Not applicable (N/A) if Topology is set to Shortest .
Min Length	Minimum allowable length of copper in a net group. Not applicable (N/A) if Topology is set to Shortest .
Trace Clearance	This is the minimum spacing allowed between the traces in the group and any other trace. You can enter a value here, or use the Group Editor . Refer to the Working with the Group Editor of Chapter 3, Setting Up a Design , section for more information.
Routing Layers	The routing layers assigned to this net group. Click to display the Layers to Apply dialog box, where you set the layers to use for routing copper.

Column	Description
Routing Priority	The routing priority for the selected net group. 1 is the highest priority, 2 the second highest, etc. Leave as None if priority routing is not required. This feature is not available in all versions of Ultiboard.
Locked	Yes indicates that the part cannot be moved. No indicates that the part can be moved.
Max Via Count	This is the maximum number of vias allowed in the net group.

Spreadsheet View: SMT Pads Tab

Use the **SMT Pads** tab to work with pad information for surface-mount devices.

Column	Description
Pad Name	The unique identifier for the pad, by RefDes and Pin Number. For example, U1, P1 is pin number one of the device with RefDes U1.
Pad Shape	The shape of the pad as set in the SMT Pin Properties dialog box. Refer to the Viewing and Editing SMT Pin Properties section of Chapter 4, Working with Parts , for more information.
Pad Radius	The radius of the pad as set in the SMT Pin Properties dialog box. Refer to the Viewing and Editing SMT Pin Properties section of Chapter 4, Working with Parts , for more information.
Pad Width	The width of the pad as set in the SMT Pin Properties dialog box. Refer to the Viewing and Editing SMT Pin Properties section of Chapter 4, Working with Parts , for more information.
Pad Height	The height of the pad as set in the SMT Pin Properties dialog box. Refer to the Viewing and Editing SMT Pin Properties section of Chapter 4, Working with Parts , for more information.

Column	Description
Trace Clearance	The clearance of the trace to parts. You can use net settings, or as set in the SMT Pin Properties dialog box. Refer to the <i>Viewing and Editing SMT Pin Properties</i> section of Chapter 4, <i>Working with Parts</i> , for more information.
Neck Length	The default length of the neck where the trace attaches to the pin, as set in the SMT Pin Properties dialog box. You can also enter the value here. Refer to the <i>Viewing and Editing SMT Pin Properties</i> section of Chapter 4, <i>Working with Parts</i> , for more information.
Neck Max	The maximum permitted length of the neck where the trace attaches to the pin, as set in the SMT Pin Properties dialog box. You can also enter the value here. Refer to the <i>Viewing and Editing SMT Pin Properties</i> section of Chapter 4, <i>Working with Parts</i> , for more information.
Neck Min	The minimum permitted length of the neck where the trace attaches to the pin, as set in the SMT Pin Properties dialog box. You can also enter the value here. Refer to the <i>Viewing and Editing SMT Pin Properties</i> of Chapter 4, <i>Working with Parts</i> , section for more information.
Min Width	The minimum permitted trace width.

Spreadsheet View: THT Pads Tab

Use the **THT Pads** tab to work with pad information for through-hole technology devices.

Column	Description
Pad Name	The unique identifier for the pad, by RefDes and Pin Number. For example, U1, P1 is pin number one of the part with RefDes U1.
Top Pad Shape	The shape of the top layer pad as set in the Through Hole Pin Properties dialog box. Refer to the <i>Viewing and Editing Through Hole Pin Properties</i> section of Chapter 4, <i>Working with Parts</i> , for more information.

Column	Description
Inner Pad Shape	The shape of the inner layer pad as set in the Through Hole Pin Properties dialog box. Refer to the <i>Viewing and Editing Through Hole Pin Properties</i> section of Chapter 4, <i>Working with Parts</i> , for more information.
Bottom Pad Shape	The shape of the bottom layer pad as set in the Through Hole Pin Properties dialog box. Refer to the <i>Viewing and Editing Through Hole Pin Properties</i> section of Chapter 4, <i>Working with Parts</i> , for more information.
Annular Ring	The size of the annular ring for this pad as set in the Through Hole Pin Properties dialog box. Refer to the <i>Viewing and Editing Through Hole Pin Properties</i> section of Chapter 4, <i>Working with Parts</i> , for more information.
Pad Diameter	The diameter of the pad as set in the Through Hole Pin Properties dialog box. Refer to the <i>Viewing and Editing Through Hole Pin Properties</i> section of Chapter 4, <i>Working with Parts</i> , for more information.
Drill Diameter	The diameter of the drill hole in the pad, as set in the Through Hole Pin Properties dialog box. Refer to the <i>Viewing and Editing Through Hole Pin Properties</i> section of Chapter 4, <i>Working with Parts</i> , for more information.
Trace Clearance	The minimum clearance permitted between the pad and traces, as set in the Through Hole Pin Properties dialog box. Refer to the <i>Viewing and Editing Through Hole Pin Properties</i> section of Chapter 4, <i>Working with Parts</i> , for more information.

Spreadsheet View: Vias Tab

Use the **Vias** tab to work with via information.

Column	Description
Assume Net	The unique identifier for the net to which the via is connected. Can be changed by using the drop-down list.
Lamination	Double-click to display the Select the lamination that is to be used for this via dialog box, where you select the layers that the via is to run between. This setting cannot be changed for micro vias.
Pad Diameter	The diameter of the via as set in the Via Properties dialog box. Refer to the <i>Viewing and Editing Via Properties</i> section of Chapter 5, <i>Working with Traces and Copper</i> , for more information.
Drill Diameter	The diameter of the drill hole in the via, as set in the Via Properties dialog box. Refer to the <i>Viewing and Editing Via Properties</i> section of Chapter 5, <i>Working with Traces and Copper</i> , for more information.
Trace Clearance	The minimum clearance permitted between the via and traces, as set in the Via Properties dialog box. Refer to the <i>Viewing and Editing Via Properties</i> section of Chapter 5, <i>Working with Traces and Copper</i> , for more information.
Locked	Yes indicates that the via cannot be moved. No indicates that the via can be moved.
Soldermask	The side of the board on which the solder mask for the via is found. Choices are: Both ; Bottom ; None ; Top .
Type	The type of via. This field is read-only.

Spreadsheet View: Copper Areas Tab

Use the **Copper Areas** tab to work with information for copper areas.

Column	Description
Layer	The layer on which the copper area is found, as set in the Copper Area Properties dialog box. Refer to the Viewing and Editing Copper Properties section of Chapter 5, <i>Working with Traces and Copper</i> , for more information.
Locked	Yes indicates that the copper area cannot be moved. No indicates that the copper area can be moved.
Net	The unique identifier for the net to which the copper area is connected.
Trace Clearance	The minimum clearance permitted between the copper area and traces, as set in the Copper Area Properties dialog box. Refer to the Viewing and Editing Copper Properties section of Chapter 5, <i>Working with Traces and Copper</i> , for more information.
Thermal Relief Style	The style of thermal relief for the copper area, as set in the Copper Area Properties dialog box. Refer to the Viewing and Editing Copper Properties section of Chapter 5, <i>Working with Traces and Copper</i> , for more information.
Spoke Width	The size of the spokes a thermal relief, as set in the Copper Area Properties dialog box. Refer to the Viewing and Editing Copper Properties section of Chapter 5, <i>Working with Traces and Copper</i> , for more information.

Spreadsheet View: Keep-ins/Keep-outs Tab

Use the **Keep-ins/Keep-outs** tab to work with information for Keep-in or Keep-out areas.

Column	Description
Name	Name of the Keep-in or Keep-out. Can be entered here, or in the Keep-in/Keep-out Properties dialog box. Refer to the <i>Working with Keep-in/Keep-out Areas</i> section of Chapter 5, <i>Working with Traces and Copper</i> , for more information.
Type	Indicates whether the area is a Keep-in or a Keep-out. Can be set here or in the Keep-in/Keep-out Properties dialog box. Refer to the <i>Working with Keep-in/Keep-out Areas</i> section of Chapter 5, <i>Working with Traces and Copper</i> , for more information.
Locked	Yes means that the Keep-in/out area cannot be moved or edited. No means that the Keep-in/out area can be moved.
Layers To Apply	Double-click to display the Layers To Apply dialog box, where you select the layers to which you wish to apply the Keep-in/out. You can also set this in the Keep-in/Keep-out Properties dialog box. Refer to the <i>Working with Keep-in/Keep-out Areas</i> section of Chapter 5, <i>Working with Traces and Copper</i> , for more information.
Net Group	Double-click to display the Select Groups dialog box, where you select the net group to which you wish to apply the Keep-in/out. You can also set this in the Keep-in/Keep-out Properties dialog box. Refer to the <i>Working with Keep-in/Keep-out Areas</i> section of Chapter 5, <i>Working with Traces and Copper</i> , for more information.

Column	Description
Part Group	Double-click to display the Select Groups dialog box, where you select the part group to which you wish to assign the Keep-in/out. You can also set this in Keep-in/Keep-out Properties dialog box. Refer to the <i>Working with Keep-in/Keep-out Areas</i> section of Chapter 5, <i>Working with Traces and Copper</i> , for more information.
Heights Bigger Than	Assign a height (z-axis) value to the Keep-in/out. Can be entered directly, or in the Keep-in/Keep-out Properties dialog box. Refer to the <i>Working with Keep-in/Keep-out Areas</i> section of Chapter 5, <i>Working with Traces and Copper</i> , for more information.

Spreadsheet View: PCB Layers Tab

Use the **PCB Layers** tab to work with layer information.

Column	Description
Layer Name	The name of the layer, for example, Copper Top .
Routable	Select Yes to allow trace routing on the layer; select No to prevent trace routing on the layer.
Trace Bias	Set the trace bias by selecting Horizontal , Vertical or None .
Type	The type of layer. Choices are Ground , Power , Signal or Unassigned .

Spreadsheet View: Parts Position Tab

Use the **Parts Position** tab to view and export part position information.

Column	Description
RefDes	The part's Reference Designator.
Position X	The part's position on the X axis.
Position Y	The part's position on the Y axis.
Side	The side of the PCB on which the part appears.
Rotation	The orientation of the part on the PCB.

Spreadsheet View: Statistics Tab

This tab displays the following statistics:

- Total number of pins.
- Pins in a net.
- Not connected pins.
- Test pins.
- Jumpers.
- Total number of vias.
- Total number of connections.
- Unrouted connections.
- Completion.
- Total number of parts.
- Total number of nets.

Customizing the Interface

The Ultiboard user interface is highly customizable. Toolbars can be docked in various positions and orientations. The contents of the toolbars may be customized. New toolbars can be created. The menu system is fully customizable, including all pop-up menus for the various object types.

The keyboard shortcut system is also customizable. This allows for any keys or key combinations to be assigned to any command that may be placed in a menu or on a toolbar.

Complete the following to customize the interface:

1. Select **Options>Customize User Interface**.
2. Make changes in the **Customize** dialog's tabs as detailed in the following sections:
 - *Commands Tab*
 - *Toolbars Tab*
 - *Keyboard Tab*
 - *Menu Tab*
 - *Options Tab*

Commands Tab

The **Commands** tab in the **Customize** dialog box is used to add commands to menus and toolbar.

Complete the following steps to add a command to a menu or toolbar:

1. Drag the desired command from the **Commands** list to the desired menu or toolbar. When a command is selected in the **Command** list, its description is displayed in the **Description** field.
2. If you do not see the command that you require, click on another selection in the **Categories** list to display more commands.
3. If you wish to add a button to a toolbar that is not showing, click on the **Toolbars** tab and click in the checkbox beside the desired toolbar to make it visible.
4. Click **Close** when customizations are complete.

To remove a command from a menu or toolbar, right-click on it and select **Delete** from the pop-up that appears. The **Customize** dialog box must be open when you do this.

To change the position of a command that is in a menu or toolbar, drag it to its new location. The **Customize** dialog box must be open when you do this.

Toolbars Tab

The **Toolbars** tab in the **Customize** dialog box is used to show or hide toolbars, and to add new custom toolbars.

Complete the following steps to use the features in this tab:

1. To display a toolbar, switch on the checkbox beside the desired toolbar in the **Toolbars** list.
2. Switch off a checkbox to hide a toolbar.



Note You cannot switch off the **Menu** bar.

3. The buttons in this tab function as follows:
 - **Reset All**—Displays the **Reset Toolbars** dialog box, where you select whether to reset the currently selected toolbars, or all toolbars. You are prompted to select the configuration file you wish to use, for example, “default.ewcfg”.
 - **New**—Displays the **Toolbar Name** dialog box, where you enter the name for a new toolbar. When you click **OK**, a new toolbar with the name that you entered is created. Follow the steps in the [Commands Tab](#) section to add buttons to the toolbar.
 - **Rename**—Use to rename a toolbar that you have created yourself. You cannot rename toolbars that are included in Ultiboard by default.
 - **Delete**—Use to delete the selected toolbar. You cannot delete toolbars that are included in Ultiboard by default.
 - **Show text labels**—Select this checkbox to show the text labels (for example, “Save”) in the toolbar, along with the command’s icon.
4. Click **Close** when customizations are complete.

Keyboard Tab

The **Keyboard** tab is used to set up keyboard shortcuts.

Complete the following steps to set up keyboard shortcuts:

1. Choose a menu from the **Category** drop-down list and the desired command from the **Commands** list. If a shortcut is already assigned, it appears in the **Current Keys** field.
2. Enter a new shortcut in the **Press New Shortcut Key** field.
3. Click **Close** when customizations are complete.

Menu Tab

The **Menu** tab is used to modify the various context-sensitive menus that appear when you right-click from various locations in Ultiboard.

Complete the following steps to display the desired menu:

1. Select the desired menu set from the **Select Context Menu** drop-down list.
2. Right-click on the menu that appears and edit as desired.
3. Select the desired menu effects using the **Menu animations** drop-down list and the **Menu shadows** checkbox.

Options Tab

Use the **Options** tab in the **Customize** dialog box to set up the appear of Ultiboard's toolbars—switch the checkboxes on or off as desired.

Customization of Pop-up Menus

To customize the appearance of toolbar buttons and menu items, a pop-up menu is available when the **Customize** dialog box is open.

Complete the following steps to display the pop-up:

1. Be sure you have the **Customize** dialog box open.
2. Right-click on either a menu item or toolbar and select the desired option.
3. When you select **Button Appearance**, the **Button Appearance** dialog box appears, where you can change the appearance of the selected toolbutton.

Beginning a Design

The following sections explain how to start a design in Ultiboard.

Some of the described features may not be available in your edition of Ultiboard. Refer to the NI Circuit Design Suite Release Notes for a list of the features in your edition.

About Designs and Projects

Designs are stored inside projects, allowing you to group them together for easy access. In this way, all designs that have a logical connection between them (that is, they may all relate to a specific project) are conveniently located in one file.

Creating a Project



Complete the following steps to create a new project file:

1. Choose **File»New Project**. The **New Project** dialog box appears.
2. Type the project name in the **Project name** field.
3. From the **Design type** drop-down list, select **PCB Design**. The other option allows you to use Ultiboard's CAD capabilities (for example, front panels, enclosures). Refer to the *Using Mechanical CAD* section for more information about these capabilities.
4. Indicate the folder where the file is to be kept. Either accept the default shown in the **Location** field, or click the browse button to select a different location.
5. Click **OK**. The **New Project** dialog box disappears, and a blank design is opened, with the same name as that of the project file. The file you just created is also shown in the **Projects** tab of the **Design Toolbox**, along with its corresponding design.

Creating a Design

A design is created automatically when you create a project file. You can also create a design and assign it to an existing project file. Remember that a design must always be associated with a project.

Complete the following steps to create a design file:

1. Choose **File»Open** and open the project to which the design is to be added.
2. Choose **File»New Design**. The **New Design** dialog box appears.
3. Type the design name in the **Design Name** field.
4. From the **Design Type** drop-down list, select PCB Design. Refer to the *Using Mechanical CAD* section of Chapter 10, *Using Mechanical CAD*, for more information on the Mechanical CAD Design file type.
5. Choose which of the open projects is to contain the design. The **Add to project** drop-down list shows only the open projects.
6. Click **OK**. The **New Design** dialog box disappears, and a blank design with the name that you specified is opened. The **Projects** tab shows that the new design is a part of the project file that you specified.



Creating a Design from a Netlist File

You can create a design based on a netlist file. A netlist contains information about a given board's nets (the electrical connections between pins) and parts. Multisim generates a .EWNET file which has all the details required to import the schematic into Ultiboard.



Note If PCB constraints are set in the Multisim file, they will also be included in the netlist file. The file also contains **Trace Width Analysis** results if you checked the **Set Node Trace Widths Using the Results from This Analysis** check box when doing the analysis in Multisim.

The following is an example of net information from a netlist file. A value of -1.000000000000 indicates that the Ultiboard default value will be used for that parameter when the file is imported into Ultiboard.

```
(nets
(net "VCC"
(trackwidth "-1.000000000000")
(trackwidth_max "-1.000000000000")
(trackwidth_min "-1.000000000000")
```

```
(tracklength_max "-1.000000000000")
(tracklength_min "-1.000000000000")
(clearance_to_trace "-1.000000000000")
(clearance_to_pad "-1.000000000000")
(clearance_to_via "-1.000000000000")
(clearance_to_copper "-1.000000000000")
(routing_layer "")
(settings_locked "0")
(net_group "")
)
```

The following is an example of component information from a netlist file.

```
(components
(instance "7SEG8DIP10A" "U1"
(device "SEVEN_SEG_DECIMAL_COM_A_BLUE")
(value "SEVEN_SEG_DECIMAL_COM_A_BLUE")
(gateswap "0")
(pinswap "0")
(component_space "0.00000000e+000")
(component_group "")
(settings_locked "0")
(comp_variants "Default1;")
(comp_variant_independent "0")
(pin "5"
(net "10")
(pintype "BIDIR")
(gategroup "")
(pingroup "")
(label "D")
(gate ""))
)
(pin "4"
(net "11")
(pintype "BIDIR")
(gategroup "")
(pingroup "")
(label "E")
(gate ""))
)
```

Complete the following steps to import a netlist file:

1. Select **File>Import>UB Netlist**, navigate to the desired file (for example, `Getting Started 2.EWNET`) and click **Open**. The **Default Trace Width and Clearance** dialog box appears.
2. Enter the desired **Units**, **Width**, and **Clearances** values and click **OK**. The **Import Netlist Action Selection** dialog box appears.
3. Select the desired actions, for example, `Add New Net : VCC` and click **OK**. A board outline is placed on the workspace with the parts ready to be placed.

Working with Projects

Designs and projects appear in the **Projects** tab of the **Design Toolbox**.

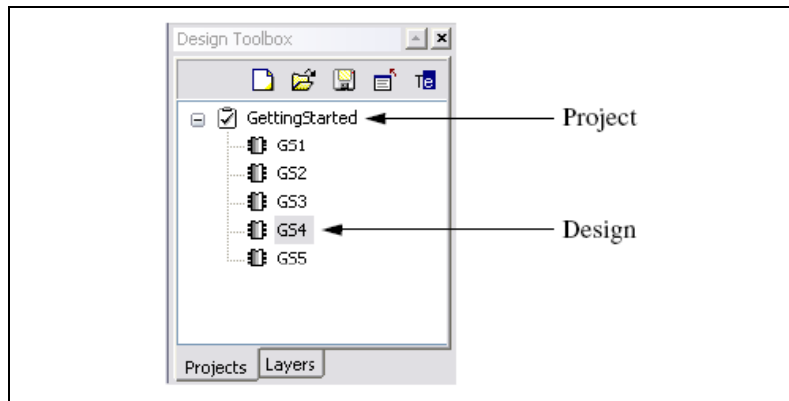

To open a project or design shown in the **Projects** tab, click on it or right-click on it and, from the context menu, choose **Open Window**.



To rename a design, right-click on it and, from the context menu, choose **Rename**. You can then type a new name for the design.

To delete a design shown in the **Projects** tab, right-click on it and, from the context menu, choose **Remove Design**. (To delete a project file, delete it from its current location on the system.)

Opening an Existing File



Complete the following steps to open an existing file:

1. Choose **File»Open**. A standard file section dialog box appears, with the **Files of Type** list defaulted to Ultiboard files.
2. In the **Files of type** list, choose the kind of file to open. You can open the following:
 - Ultiboard files (*.ewprj).
 - Orcad files (*.max, *.llb).
 - Protel files (*.pcb, *.ddb).
 - Gerber files (*.g).
 - DXF files (*.dxf).
 - Ultiboard 4 & 5 design files (*.ddf).
 - Ultiboard 4 & 5 libraries (*.l55).
 - Netlist files (*.ewnet, *.net, *.nt7).
 - Calay netlist files (*.net).



Note To view all files in the folder created by NI Circuit Design Suite software, and any other software, select *.*.

3. Select a file from the list displayed and click **Open**. The file opens, along with its associated project.
 - If you open an Ultiboard project file, you see the designs within that project in the **Projects** tab
 - If you opened a .ddf file, you see the design appear in the workspace. A file with the same name is created automatically.

Saving and Closing



To save a file, right-click on the project file name in the **Projects** tab and, from the context menu, choose **Save** or choose **File»Save**. Saving a file also saves the designs in the file. You can also select a file in the **Projects** tab and click the save icon. Saving a design also saves a file (and therefore any other designs in the file).

To save a file with a new name and/or location, choose **File»Save As** and provide the new name and/or location. All designs in the file are saved in the new location.



To save all open file and designs, choose **File»Save All**.

To close the current file and its designs, choose **File»Close**. If you have any unsaved changes in the file or designs, you are prompted to save the file and/or designs.

To close all open projects and designs, choose **File»Close All**. If you have any unsaved changes in the projects or designs, you are prompted to save the projects and/or designs.

Saving Technology Specifications from a Design

You can save the technology specifications from the current design into a technology file. This technology file can be used to import technology settings into another design.

Complete the following steps to save a design's technology specifications:

1. Have the desired design open in Ultiboard.
2. Select **File»Save Technology**. The **Technology File Settings** dialog box appears.
3. Select the technology parameters you want to save and click **OK**. A standard Windows Save dialog appears. Select the desired location for the technology file, enter its name in the **File name** field and click **Save**.

Loading Technology Files

You can load technology specifications from a technology file that you saved earlier. Refer to the *Saving Technology Specifications from a Design* section for more information.

Complete the following steps to load technology into the active file:

1. Select **File»Load Technology**. A standard Windows Open dialog appears.
2. Navigate to the desired folder, highlight the desired technology file and click **Open**. The **Technology Import** dialog displays.
3. Select the desired items to load into your open design file and click **OK**.

Selecting and Unselecting Elements

You can select and unselect single and multiple elements in a design such as parts, holes, and traces.

To select a single element on a board, click the element. A dotted line around the element, or running through the trace, indicates that it has been selected.

Complete the following to select multiple elements on a board:

Hold down the Shift key while clicking the elements that you want to select.

Or

Click and drag to draw a box around the elements you wish to select. When you release the mouse button, the elements that were inside the box are selected.



To select all elements on a board, choose **Edit»Select All** or press <Ctrl-A>.

Complete the following steps to select an entire trace, not just a trace segment:

1. Select a segment belonging to the trace you want to select.
2. Choose **Edit»Select Entire Trace**. The entire trace is then selected.

To unselect one element, select another element or click outside of the board outline.

To unselect one element in a group of selected elements, hold the Ctrl key down and click the element to be unselected.

Using Selection Filters

As you add more parts and traces to a board, it can become more difficult to select only those which you want to use. Ultiboard provides you with selection filters to allow controlled selections. The selection filters are found in **Edit»Selection Filter** and the **Select** toolbar. By default, all the selection filters are on, that is, you can select any element. Use the filters to select or not select specific elements by toggling the choices on and off. For example, to select only traces, disable the other selection filters and enable only the traces one. As you work through your design, you will find different combinations of selection filters helpful to prevent accidentally selecting (and potentially modifying) elements.

Place and Select Modes

Ultiboard assumes that placing shapes, parts, or traces on a board are actions you are likely to repeat. As a result, when you place items on the board, you remain in “place mode” (the cursor has a small icon attached, indicating what is being placed) so that you can continue to place the same type of item repeatedly. After placing a shape, part, or trace on a board, the pointer continues to carry the icon, and is ready to place another object like the one you just placed. You must cancel this mode and return to “select mode” in order to perform other functions.

Complete the following to cancel the place mode and return to select mode:

1. Right-click

Or

Press <Esc>

Or

Choose **Place»Select**.



Searching for Design Elements

To find out if an element exists in an open project, you can search for it with the **Edit»Find** command. While this command works much like a Find function in other applications, it also allows you to search for an element by name, by number, by shape, by value, or by all variables.

Complete the following steps to find an element in an open design:

1. Choose **Edit»Find**. The **Find** dialog box appears.
2. In the **Find what** field, enter what you want to search for. You can search for an element by specifying any of the values of its attributes (for example, name, number, shape), with or without wildcards. If you leave this field blank, you will find all elements in the design.



Note The **Find what** drop-down list shows all the searches you have made in this session.

3. To constrain your search to only certain attributes, choose from the **Find special** drop-down list. For example, if you enter “test” in the **Find what** field, you will find all elements with the string “test” in any of their attributes. However, if you choose **Name** from the **Find special** drop-down list, you will find only elements with “test” in their name.
4. Optionally, enable the **Match case** and/or **Match whole word** check boxes.
5. Click **Find**. The search results appear in the **Results** tab of the **Spreadsheet View**.
6. Click on the **Results** tab in the **Spreadsheet View**.
7. To navigate to one of the found elements, double-click it in the **Results** tab.

Or

Right-click on the desired element and select **Go to** from the pop-up menu that appears.

The element is selected and shown in the workspace.

To clear the information in the **Results** tab, right-click anywhere in the **Results** tab and select **Clear Results** from the pop-up menu that appears.

Options for Viewing the Design

Your view of the design can be manipulated a number of ways to make things easier to see while editing, as well as to see what the finished design will look like.

Using the Full Screen

When you open Ultiboard for the first time, the program displays the workspace with the menu and toolbars, the **Birds Eye View** and the **Design Toolbox**. To get a better view of the workspace, you can either use the zoom functions to magnify it, or have the workspace take up the full screen. Refer to the [Magnifying and Shrinking the View](#) section for more information about the zoom functions.

When you display a design on the full screen, everything except the design disappears (depending on your settings in the **Preferences** dialog box, scrollbars may or may not appear). Menu functions can still be used through their keyboard shortcuts—for example, you can use F8 to zoom in, and F9 to zoom out. Again, depending on the **Preferences** dialog box settings, you may be able to pan through the design by moving your cursor over the outside edges.



To switch the workspace to a full screen display, choose **View»Full Screen**.

Complete the following steps to return from the full screen display to the multi-screen display:



1. Locate the **Full Screen Close** button. It will be floating over the design.
2. Click the **Full Screen Close** button to return to the multi-pane display.

Magnifying and Shrinking the View

You can use the zoom functions to magnify or shrink all or part of the design.

To magnify part of the design, choose **View»Zoom In**, or press <F8>. You may need to adjust your view of the magnified design by using the scroll bars.

Complete the following to magnify a selected area on the design:

1. Choose **View»Zoom Window**, or press <F6>, then click and drag a rectangular area on the board to define the area to be zoomed in on.

Or

Define an area by clicking and dragging in the **Birds Eye View**.

To shrink the view of the design, choose **View»Zoom Out**, or press <F9>.

To return to the full view of the design after zooming in or out, press <F7>.

Refreshing the Design

After adding and changing elements, the design can begin to look a little confusing, with bits and pieces of elements looking like they have been left behind on the design after being moved, for example. This can be for many reasons, including the limitations of the computer monitor being used, although it does not affect the design.

Complete the following to clean up the design, removing any extraneous images that should not be there:



1. Choose **View»Redraw Screen**.

Or

Click **Redraw** in the **View** toolbar or press <F5>.

Tool-tip Label

Complete the following to change your cursor to include a tool-tip label that contains object information:

1. Hold down the Ctrl key as you move your mouse over the workspace. The information in the label changes depending on the object over which it hovers.

Setting Up a Design

The following sections explain the basic functions you must perform to get your board set up. These tasks should be performed before you begin placing parts and/or traces.

Some of the described features may not be available in your edition of Ultiboard. Refer to the NI Circuit Design Suite Release Notes for a list of the features in your edition.

Working with Layers

The following are discussed in this section:

- *Defining Copper Layers*
- *Accessing Layers*

Defining Copper Layers

Ultiboard lets you define boards from 2 to 64 layers thick. Your initial design decisions are important because it is difficult to change the design, for example, from a 6-layer design with blind and buried vias to a normal feed-through design, after the board has been completed. Your decisions are also important in terms of manufacturing cost. A 6-layer board with blind and buried vias will cost significantly more to manufacture than a 4-layer board with normal feed-through vias.

When setting the number of copper layers you also select the lamination settings that will be used when the board is manufactured. This is important as these settings are used by Ultiboard's internal design rule engine when placing blind and buried vias or micro vias.

There are two methods of fabricating a PC board (both methods can be used in combination):

- The first method uses layered pairs of copper on a substrate (usually cured fiberglass/resin) that have been etched and are then laminated together with a partially cured fiberglass/resin substrate (prepreg). Heat and mechanical pressure are used to activate the prepreg and bond layered pairs with other layered pairs.

- The other method typically uses a layered pair as a core to which single layers of copper foil are added to build up the board. Prepreg is also used to bond the layers. Build-up layers are usually added in equal numbers to the top and bottom of the core to prevent warping of the final product.

A via is a plated through-hole in a printed circuit board used to connect two or more layers, as well as the top and bottom surfaces of the board.

- **Blind via**—Any via that connects the top or bottom layer of a board to one of the internal layers.
- **Buried via**—Any via that connects internal layers.
- **Normal through-hole via**—Any via that connects all layers (top, bottom, and internal).
- **Micro via**—A via that is less than 5 mils in diameter, that connects a maximum of two build-up layers only.

The lamination sequence used determines the acceptable layer combinations for placing blind and buried vias or microvias. For example, if all layers are layered pairs then blind vias can only be placed between an outer layer and completely through a layered pair (see diagram for an example). Once the lamination sequence is determined, Ultiboard calculates the acceptable layer combinations for blind and buried vias or micro vias. You then choose which ones to use in your design from these possible combinations.

The figure below shows a cross-section of a multi-layer PCB.

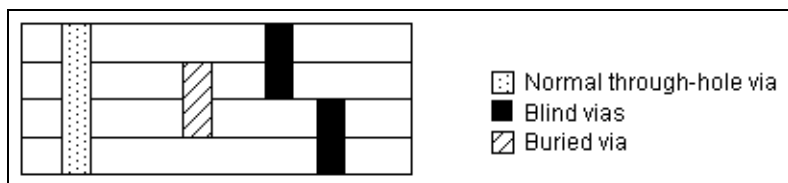

The number of copper layers in a board can be set in either the **Board Wizard** or in the **PCB Properties** dialog box. Refer to the [Using the Board Wizard](#) section and the [Copper Layers Tab](#) section of Chapter 1, [User Interface](#), for more information.

Accessing Layers

The **Layers** tab of the **Design Toolbox** allows you to move through the layers of your PCB design, and control their appearance.

To display the **Layers** tab, click the **Layers** tab in the **Design Toolbox**. The tab appears, as shown in the figure below:

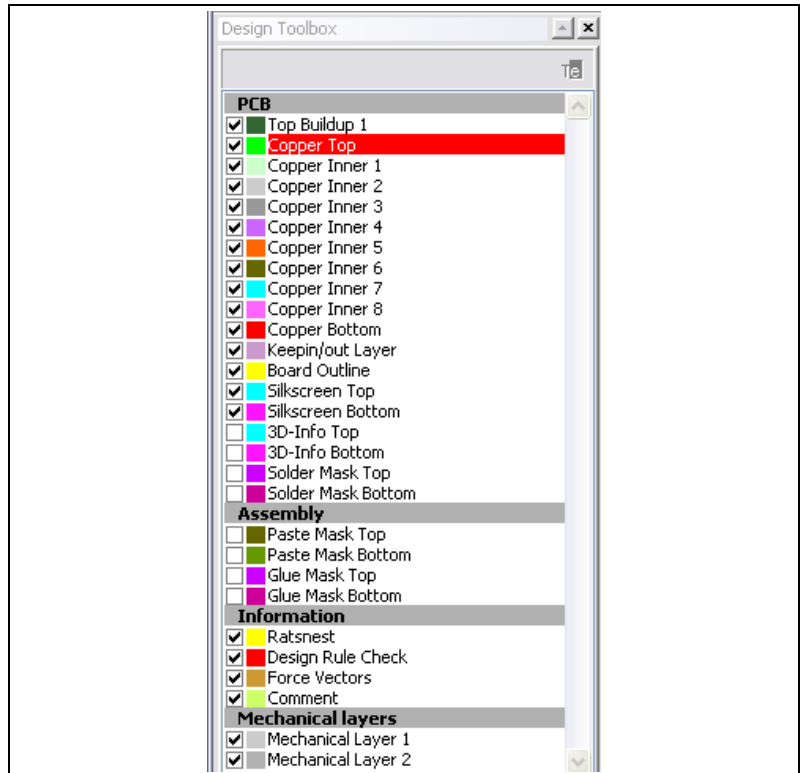

Layers with a check mark are displayed on the workspace. Layers with a check mark in a grey box are displayed in the workspace, but are dimmed. Layers with no check mark are not displayed in the workspace, but are available to be used.

The highlighted layer is the active layer, that is, the one you are working with.

Click the colored icons beside the checkboxes to control the layers' colors.

The **Layers** tab is divided into four sections:

- **PCB**—These are the working layers of your design. Refer to the [Setting PCB Properties](#) section of Chapter 1, *User Interface*, for more information about setting up the properties of the PCB layers.
- **Assembly**—These are the layers associated with production of your board. These are useful whenever you are using paste to hold joints or glue (adhesive) to hold components on the board (mostly on SMDs).
- **Information**—These are “virtual” layers, which provide useful design information but are not part of the physical board itself.
- **Mechanical layers**—These are the layers to be used for documentation (for example, showing dimensions) or other mechanical CAD-related properties. You can also set up projects and files that contain CAD information. Refer to Chapter 10, [Using Mechanical CAD](#), for more information.

The layer highlighted in red is the active layer—The one which any functions you choose will affect. Before you can work on a particular layer, you must ensure that layer is active. Depending on what layer is active, your available commands and toolbars may change.



Tip Ultiboard presents only those functions that are appropriate for the current layer. For example, if you are on a **Paste Mask** layer, you cannot use the **Place** menu to place a copper area.

To make a layer the active layer, double-click on the name of the layer in the **Design Toolbox**.

You can also change the visibility of layers by making them visible, dimmed or hidden.

To dim a layer in the workspace, making it easier to see the elements on other layers, click the layer’s check box. The check box turns gray, and the elements of that layer dim.

To hide a layer in the workspace, click the layer’s check box twice. The check mark disappears, and the elements on that layer are hidden.



Note While this action removes the elements of the layer from view, neither the layer nor the elements are deleted from the design.



Tip You can show or hide individual ratsnests from the **Show Ratsnest** column in the **Nets** tab of the **Spreadsheet View**, and also from the **Net Edit** dialog box. Refer to the [Using the Netlist Editor](#) section of Chapter 5, *Working with Traces and Copper*, for more information.

To change the color of the elements in a layer, click the color box beside the layer name and, from the dialog box that appears, choose a color. All existing elements on that layer, and any elements added to that layer, are displayed in that color, with the exception of shapes where you can choose the line or fill color from the toolbar prior to placing them. Refer to the [Placing Shapes and Graphics](#) section of Chapter 4, *Working with Parts*, for more information.

Working with the Board Outline

The **Board Outline** layer is empty for new designs. You can create a board outline in one of the following ways:

- Draw a board outline using the drawing tools. Refer to the [Using the Drawing Tools to Create a Board Outline](#) section for more information.
- Import a DXF file. Refer to the [Importing a DXF File](#) section for more information.
- Place a pre-defined outline from the database. Refer to the [Using a Pre-Defined Board Outline](#) section for more information.
- Use the **Board Wizard**. Refer to the [Using the Board Wizard](#) section for more information.

Using the Drawing Tools to Create a Board Outline

Complete the following steps to create a new board outline using the drawing tools:

1. Double-click the **Board Outline** layer in the **Layers** tab of the **Design Toolbox**.
2. Using **Place»Shape**, draw the shape you want for your board outline. For example, choose **Place»Shape»Rectangle** and drag the mouse until the rectangle is the desired height and length. Click to anchor it in place.



Note To draw the shape based on precise coordinates, press the asterisk key (*) on the numeric keypad, or press <Shift-8>. The **Enter coordinate** dialog box appears. Enter the **X** and **Y** coordinates and press **OK**. Continue to use the asterisk key (*) or <Shift-8> for the remaining coordinates. You can mix the use of the asterisk key (*) or <Shift-8> and clicking to position each corner.

To edit the properties of the placed board outline, select the outline and select **Edit»Properties**. (You must be on the **Board Outline** layer).

Importing a DXF File



Complete the following steps to import a DXF board outline from a CAD program such as AutoCAD®:

1. Choose **File»Import»DXF**. A standard file selector appears.
2. Navigate to the correct location for the `.dxf` file, select it and click **OK**.
3. The **DXF import settings** dialog box appears.
4. In the **Layers** box, set the following as desired:
 - **Import layers from file** radio button—Creates layer names that correspond to the original DXF files
 - **Merge import data into existing layer** radio button—Merges DXF file layers into the layer chosen from the drop-down list.
5. In the **Units** box, set the following as desired:
 - **Interpret units in file as** radio button—Select a unit of measure from the drop-down list.
 - **Scale import data to fit board outline**—Select if you want to scale the imported data to fit the current board outline.
6. Optionally, enable the **Convert closed objects to filled** checkbox. This indicates if closed objects are to be converted to filled objects.
7. Click **OK** to import the file.

Using a Pre-Defined Board Outline

Complete the following steps to use a board outline from the Ultiboard database:

1. Choose **Place»From Database** to display the **Get a part from the database** dialog box.
2. Navigate to the **Board Outlines** section and select the outline you want to use.
3. Click **OK** to close the dialog.
4. Click to place the board outline on the design.

Using the Board Wizard



Complete the following steps to use the **Board Wizard**:

1. Choose **Tools»Board Wizard**. The **Board Wizard... Board Technology** dialog box appears.
2. Enable the **Change the layer technology** option. Choose the board technology and click **Next**. Refer to the [Defining Copper Layers](#) section for more information about board technology.

The next step of the wizard depends on which type of technology you chose.

3. If you chose **Multi-layers constructed with double sided board (layer pairs)**, define the lamination settings for the board:
 - Select **Top Layer** and **Bottom Layer** as desired.
 - Set the number of layer pairs you intend to use by entering the value or using the up/down arrows in the **Layer Pairs** field. There should be at least one layered pair to act as a core.
 - Select the **Blind Vias** or **Buried Vias** checkboxes to use these in your design.
 - As you make changes to the layer settings, the information window shows the acceptable layer combinations for blind and buried vias. In this window, select the layer combinations you want to allow in your design.
 - Click **Next**.

If you chose **Multi-layers constructed with double sided boards and single layer stack-ups**, define the lamination settings for the board as follows:

- Select **Top Layer** and **Bottom Layer** as desired.
- Set the number of layer pairs you intend to use by entering the value or using the up/down arrows in the **Layer Pairs** field. There should be at least one layered pair to act as a core.
- Set the number of **Single Layer Build-ups** for both the top and bottom. There should be at least one layered pair to act as a core.
- Select the **Blind Vias**, **Buried Vias**, or **Micro Vias** checkboxes to use these in your design.
- As you make changes to the layer settings, the information window shows the acceptable layer combinations for blind and buried vias or microvias. In this window, select the layer combinations you want to allow in your design.
- Click **Next**.

4. If you chose **Single Sided** or **Double Sided**, or upon clicking **Next** after defining the lamination settings for a multi-layer board:
 - Define the default **Units** of measurement for the design.
 - Define the board **Reference Point**. This can be changed later. Refer to the *Setting the Board's Reference Point* section for more information.
 - Define the **Board Shape and Size**.
 - Set the default **Clearance** for the board—This is the distance from the edge of the board that is to be kept free of any other elements. Trying to run a trace through a clearance, or trying to place a part so that a pad is put within a clearance, for example, results in a design rule error.
5. Click **Finish**. The board outline is placed on your design.

Setting the Board's Reference Point

The reference point of the board is important for relating physical dimensions to PCB layouts, since all measurements are shown relative to this origin point. If you used the **Board Wizard**, this reference may already have been set. Refer to the *Using the Board Wizard* section for more information.

Complete the following steps to set a reference point:



1. Choose **Design»Set Reference Point**. The cursor changes as shown in the figure below.

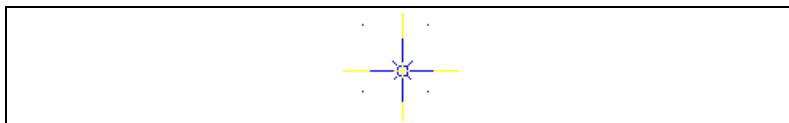

2. Click to place the reference point. In the example below, the reference point has been placed at the lower left corner of the board outline.

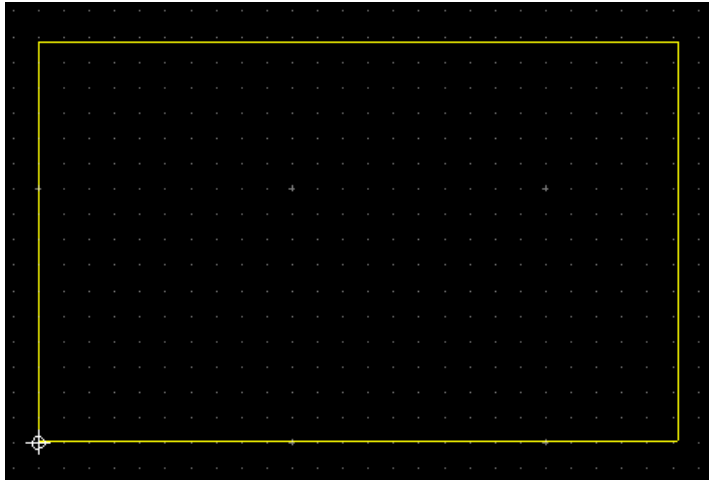

Enter coordinate dialog box

Complete the following steps to set the reference point at precise X, Y coordinates:

1. Press the asterisk key (*) or <Shift-8> to display the **Enter coordinate** dialog box.
2. Enter the **X** and **Y** coordinates and the desired units of measure.
3. Optionally, select **Snap to grid** to have the reference point snap to the closest grid on the workspace.



Note If you do not have a part selected and you press the * key or <Shift-8>, the dialog is populated with the coordinates of the mouse. Click **OK** to center the screen to these coordinates. If you have a part selected when you press the * key or <Shift-8>, the dialog is still populated with the coordinates of the mouse. Click **OK** to move the selected part to that position.

Design Rule Errors

Design rule errors appear in the **DRC** tab of the **Spreadsheet View** as they occur, and disappear as they are corrected.

Double-click on an error in the **DRC** tab to zoom in on the affected area on the design, which will be indicated with a red circle, as shown in the example below.

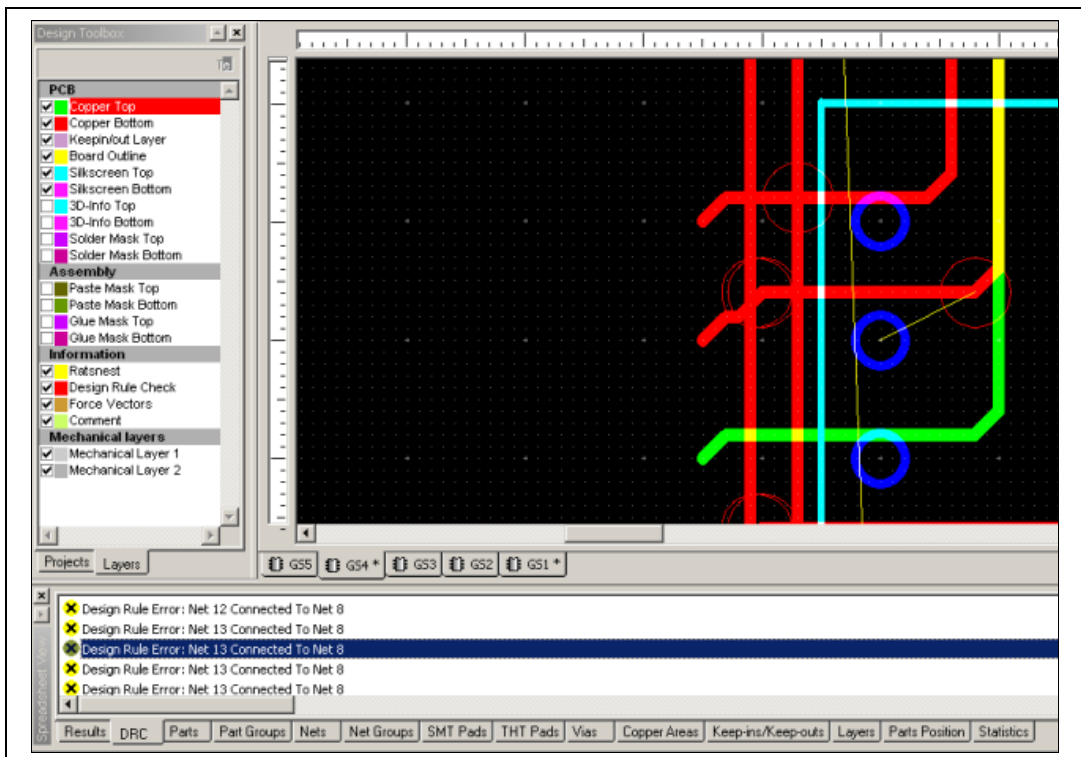

Depending on what you are doing on the board, you may see the following kinds of errors if you keep the **DRC** tab open while you work:

- **Part “[refdes]”(value) has an unknown shape (shape name)**—The given part has a shape defined that does not exist in the database.
- **Part “[refdes]” is Not On the design**—The part with the given refdes was specified in the netlist but is not present on the design.

- **Pin “[Pin number]” from Part “[refdes]”(value) in Net “[Net name]” is missing from shape “[shape name]”**— A pin belonging to the specified part was given in the netlist but does not exist in the shape that was given for the part.
- **Unused Pin [Pin name] is {close to, connected to} {Unused Pin, Copper}**—The given pin that was not assigned to a net is close to or connected to another unused pin or copper, for example, a trace, powerplane, or copper area.
- **Design Rule Error: Net [Net1 name] { connected to} { Net2 name, Unused pin, copper, Board outline }**—The given net was connected to another net, an unused pin, copper or the board outline.
- **Design Rule Error: Net Gnd Close to Net [Net name] [RefID:PIN#-netname]**—The given net was too close to another net.

You can set up whether the design rule check runs in “real time”, and define the actions to be taken when Ultiboard encounters a design rule error, such as cancelling the current action, asking for confirmation, or overruling the error. Refer to the *PCB Design Tab* section of Chapter 1, *User Interface*, for more information.

Working with the Group Editor

The **Edit Groups** dialog box is where you create and edit net groups, part groups, bus groups and differential pairs.

Refer to the following sections for more information:

- *Add Group dialog box*
- *Working with Net Groups*
- *Working with Part Groups*
- *Working with Bus Groups*
- *Working with Differential Pairs*

Add Group dialog box

Use the **Add group** dialog box to create groups in the **Edit Groups** dialog box. Refer to the following subjects for more information:

- *Working with Net Groups*
- *Working with Part Groups*
- *Working with Bus Groups*
- *Working with Differential Pairs*

Working with Net Groups

Complete the following steps to create a net group:

1. Select **Tools»Group Editor** to display the **Edit Groups** dialog box.
2. Click the **Net Groups** tab.
3. Click **Add**. The **Add group** dialog box appears.
4. Enter the desired name and click **OK**. The **Change group settings** dialog box appears.
5. Change the settings in the **Group Settings** area as desired.



Note Refer to the [Change Group Settings dialog box](#) and [Net Group Settings](#) sections for more information.

6. Click **OK** to return to the **Net Groups** tab. The newly created group appears in the **Groups** list.
7. Highlight the new group to display a list of nets you can add to the group in the **Assign Nets** list, as shown in the example below.

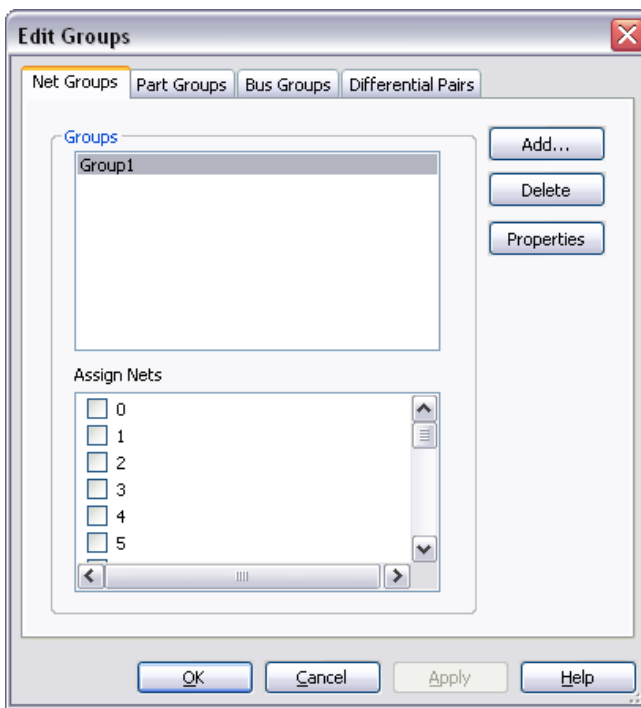

- Click checkboxes beside the desired nets in the **Assign Nets** list and click **Apply** to add them to the group.



Note You cannot assign a net to more than one group. Therefore, nets that are already assigned to another net group do not appear in the **Assign Nets** list.

- Click **OK** to close the **Edit Groups** dialog box.

Complete the following steps to edit a net group:

- Select **Tools»Group Editor** to display the **Edit Groups** dialog box.
- Select the **Net Groups** tab.
- Highlight the desired group in the **Groups** list.
- Change the net assignments as desired and click **Apply**.
- Optionally, highlight the desired group in the **Groups** list and click the **Properties** button to display the **Change group settings** dialog box.
- Make the required changes in the **Group Settings** area and click **OK**.



Note Refer to the [Change Group Settings dialog box](#) and [Net Group Settings](#) sections for more information.

Complete the following steps to delete a group:

- Select **Tools»Group Editor** to display the **Edit Groups** dialog box.
- Select the **Net Groups** tab.
- Highlight the desired group in the **Groups** list and click **Delete**.

Working with Part Groups

Complete the following steps to create a part group:

- Select **Tools»Group Editor** to display the **Edit Groups** dialog box.
- Click the **Part Groups** tab.
- Click **Add**. The **Add group** dialog box appears.
- Enter the desired name and click **OK**. The **Change group settings** dialog box appears.
- Change the settings in the **Group Settings** area as desired.



Note Refer to the [Change Group Settings dialog box](#) and [Part Group Settings](#) sections for more information.

6. Click **OK** to return to the **Part Groups** tab. The newly created group appears in the **Groups** list.
7. Highlight the new group to display a list of parts you can add to the group in the **Assign Parts** list, as shown in the example below.

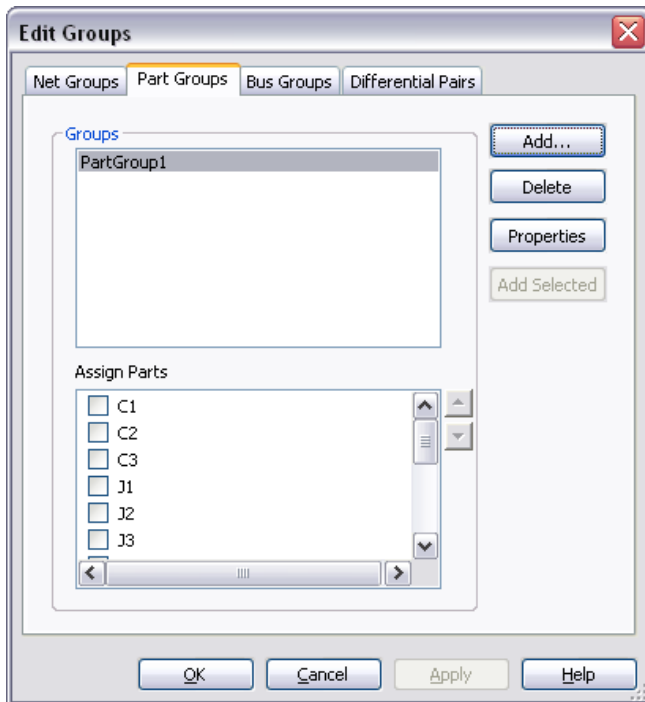

8. Click checkboxes beside the desired parts in the **Assign Parts** list and click **Apply** to add them to the group.



Note You cannot assign a part to more than one group. Therefore, parts that are already assigned to another group do not appear in the **Assign Nets** list.

9. Click **OK** to close the **Edit Groups** dialog box.



Tip When adding parts to a **Part Group**, you can select parts on the workspace and then click **Add Selected** in the **Part Groups** tab—the selected parts are added to the group.

Complete the following steps to edit a part group:

1. Select **Tools»Group Editor** to display the **Edit Groups** dialog box.
2. Select the **Part Groups** tab.
3. Highlight the desired group in the **Groups** list.
4. Change the part assignments as desired and click **Apply**.
5. Optionally, highlight the desired group in the **Groups** list and click the **Properties** button to display the **Change group settings** dialog box.
6. Make the required changes in the **Group Settings** area and click **OK**.



Note Refer to the [Change Group Settings dialog box](#) and [Net Group Settings](#) sections for more information.

Complete the following steps to delete a group:

1. Select **Tools»Group Editor** to display the **Edit Groups** dialog box.
2. Select the **Part Groups** tab.
3. Highlight the desired group in the **Groups** list and click **Delete**.

Working with Bus Groups

Set up a bus group for traces that you wish to route as closely together as possible.

Complete the following steps to create a bus group:

1. Select **Tools»Group Editor** to display the **Edit Groups** dialog box.
2. Click the **Bus Groups** tab.
3. Click **Add**. The **Add group** dialog box appears.
4. Enter the desired name and click **OK**.
5. The newly created group appears in the **Assign Nets** list.
6. Highlight the new group to display a list of nets you can add to the group in the **Assign Nets** list, as shown in the example below.

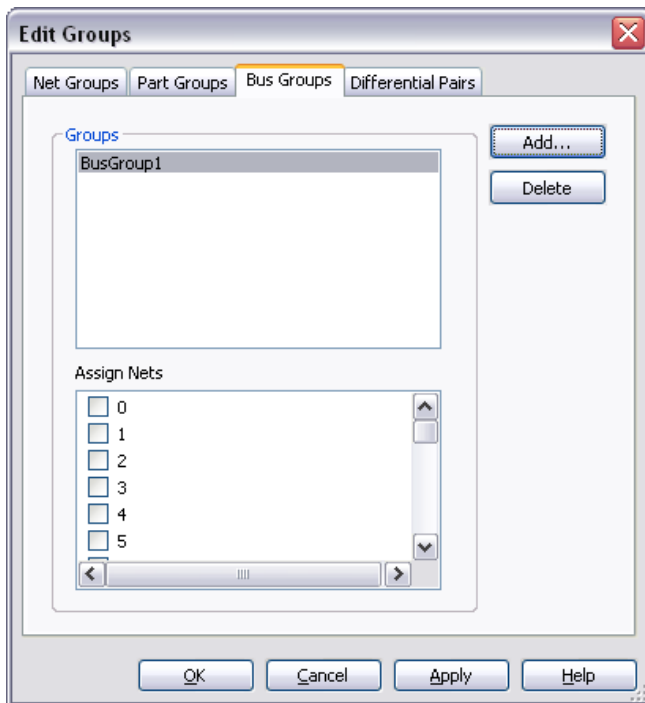

7. Click checkboxes beside the desired nets in the **Assign Nets** list and click **Apply** to add them to the group.



Note You cannot assign a net to more than one group. Therefore, nets that are already assigned to another bus group do not appear in the **Assign Nets** list.

8. Click **OK** to close the **Edit Groups** dialog box.

Complete the following steps to edit a bus group:

1. Select **Tools»Group Editor** to display the **Edit Groups** dialog box.
2. Select the **Bus Groups** tab.
3. Highlight the desired group in the **Groups** list.
4. Change the net assignments as desired and click **Apply**.

Complete the following steps to delete a group:

1. Select **Tools»Group Editor** to display the **Edit Groups** dialog box.
2. Select the **Bus Groups** tab.
3. Highlight the desired group in the **Groups** list and click **Delete**.

Working with Differential Pairs

Complete the following steps to create a differential pair:

1. Select **Tools»Group Editor** to display the **Edit Groups** dialog box.
2. Click the **Differential Pairs** tab.
3. Click **Add**. The **Add group** dialog box appears.
4. Enter the desired name and click **OK**. The **Change group settings** dialog box appears.
5. Change the settings in the **Group Settings** area as desired.



Note Refer to the [Change Group Settings dialog box](#) and [Differential Pair Settings](#) sections for more information.

6. Click **OK** to return to the **Differential Pairs** tab. The newly created group (differential pair) appears in the **Groups** list.
7. Highlight the new group to display a list of nets you can add to the group in the **Assign Nets** list, as shown in the example below.

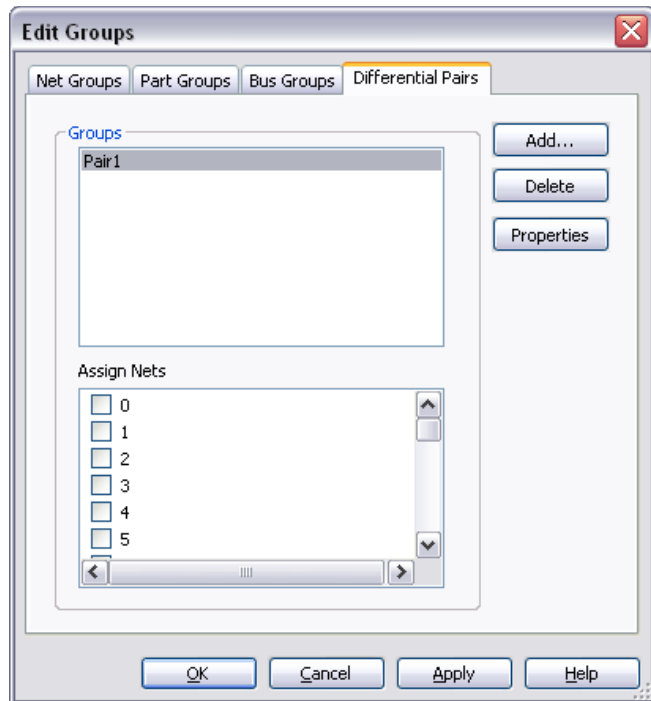

8. Click two checkboxes beside the desired nets in the **Assign Nets** list and click **Apply** to add them to the group.



Note You cannot assign a net to more than one differential pair. Therefore, nets that are already assigned to another differential pair do not appear in the **Assign Nets** list.

9. Click **OK** to close the **Edit Groups** dialog box.

Complete the following steps to edit a bus group:

1. Select **Tools»Group Editor** to display the **Edit Groups** dialog box.
2. Select the **Differential Pairs** tab.
3. Highlight the desired group in the **Groups** list.
4. Change the net assignments as desired and click **Apply**.
5. Optionally, highlight the desired group in the **Groups** list and click the **Properties** button to display the **Change group settings** dialog box.
6. Make the required changes in the **Group Settings** area and click **OK**.



Note Refer to the *Change Group Settings dialog box* and *Differential Pair Settings* sections for more information.

Complete the following steps to delete a group:

1. Select **Tools»Group Editor** to display the **Edit Groups** dialog box.
2. Select the **Differential Pairs** tab.
3. Highlight the desired group in the **Groups** list and click **Delete**.

Change Group Settings dialog box

Access this dialog box from the **Edit Groups** dialog box. Refer to the *Working with the Group Editor* section for more information.

Use this dialog box to change the group settings for net groups, part groups, and differential pairs.

The options found in this dialog box depend on the type of group. Refer to the following sections for more information:

- *Net Group Settings*
- *Part Group Settings*
- *Differential Pair Settings*

Net Group Settings

For net groups, the following **Group Settings** are available:

- Group Name
- Clearance Settings
- Trace Width Settings
- Trace Length Settings
- Routing Layers
- Routing Priority
- Locked

As well as setting the clearance for a net group, you can set clearances for individual nets within that group. You can, for example, set the clearance for the net group to 10 mils, and the clearance for two or more nets within that group to 5 mils. In this case, if any net from the group comes within 10 mils of any element that is not in the net group, a DRC error is generated. If one of the traces that you set to a 5 mils clearance moves to 5 mils or less from one of the other traces with the 5 mils clearance setting, a DRC error occurs.



Note Set individual trace clearances in the **Nets** tab of the **Spreadsheet View**. To do this, select the desired trace, and locate the **Trace Clearance** column. Highlight **Use Group Settings** and type in the desired clearance for that trace. You can also edit a trace's clearance from the **General** tab of its properties dialog box.

For information on any setting, select it in the **Group Settings** list. A description appears in the field at the bottom of the dialog. You may need to make the dialog box larger to view some of the descriptions. Do this by dragging the dialog's lower-right corner.

Part Group Settings

For part groups, the following **Group Settings** are available:

- Group Name
- Clearance Settings
- Part Spacing Settings
- Pin & Gate Swapping Settings

For information on any setting, select it in the **Group Settings** list. A description appears in the field at the bottom of the dialog. You may need to make the dialog box larger to view some of the descriptions. Do this by dragging the dialog's lower-right corner.

Differential Pair Settings

For differential pairs, the following **Group Settings** are available:

- Length Constraints
- Space Constraints

For information on any setting, select it in the **Group Settings** list. A description appears in the field at the bottom of the dialog. You may need to make the dialog box larger to view some of the descriptions. Do this by dragging the dialog's lower-right corner.

Working with Parts

The following sections explain how to work with parts as you create and edit designs. It covers the ways that you can place parts on the board, as well as the tools included to help you with part location and placement. It also includes information on Ultiboard's parts database, and editing the parts in the database and on the board.

Some of the described features may not be available in your edition of Ultiboard. Refer to the NI Circuit Design Suite Release Notes for a list of the features in your edition.

Placing Parts

You can place parts on the design:

- by dragging them from outside the board outline. Refer to the *Dragging Parts from Outside the Board Outline* section for more information.
- by using the **Spreadsheet View**. Refer to the *Using the Parts Tab in the Spreadsheet View* section for more information.
- by importing a netlist. Refer to the *Creating a Design from a Netlist File* section of Chapter 2, *Beginning a Design*, for more information.
- by selecting parts from the database. Refer to the *Placing Parts from the Database* section for more information.



Note Before placing a part, make sure that you are on the layer where the part is to be placed. Refer to the *Accessing Layers* section of Chapter 3, *Setting Up a Design*, for more information.

Dragging Parts from Outside the Board Outline

By default, parts are placed outside the board outline when you open a netlist from Multisim or another schematic capture program. These can be dragged to the appropriate location on the board.

Complete the following steps to drag a part from outside the board outline:

1. Click on the part and drag it to the appropriate location. The placed part remains highlighted.
2. Click anywhere on the workspace, or right-click, to de-select the part.

Using the Parts Tab in the Spreadsheet View

The **Parts** tab in the **Spreadsheet View** shows a list of all the parts in your design.

The **Parts** tab is also where you select parts, lock parts so they cannot be accidentally moved, and place parts on the board. It also contains functions to help you find parts on the board, and preview a selected part.

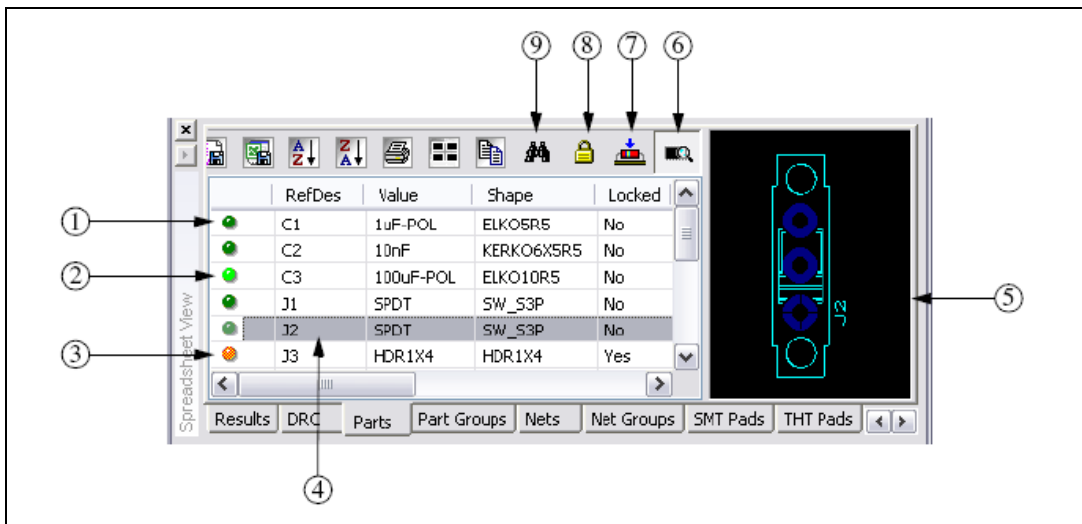

- | | | |
|--------------------------|---|-------------------------------|
| 1 Dark Green Indicator | 5 Preview of Selected Part | 8 Lock Selected Parts Button |
| 2 Bright Green Indicator | 6 Show or Hide Preview Button | 9 Find and Select Part Button |
| 3 Orange Indicator | 7 Start Placing Unpositioned Parts Button | |
| 4 Selected Part | | |

The dark green indicator (1) shows that the part has not been placed within the board outline. If all parts' indicators are dark green, there may be no board outline defined.

The bright green indicator (2) shows that the part has been placed within the board outline.

The orange indicator (3) shows that the part has been locked in place.

The selected part (4) appears in the preview area (5). Deselect the **Show or Hide Preview** button (6) if you do not wish to see the preview.

Use the **Start Placing the Unpositioned Parts** button (7) to place unplaced parts.

Use the **Lock Selected Parts** button (8) if you do not want a part to be moved.

Use the **Find and Select Part** button (9) to quickly locate a part on the design.



Note Refer to the [Spreadsheet View](#) section of Chapter 1, [User Interface](#), for information about the other buttons in the **Spreadsheet View**.

Using the Parts Tab to Place Parts

Complete the following steps to place a single part on the board:

1. Click-and-drag the part from the list to the design. The selected part is attached to the pointer as you move it over the board.
2. Release the mouse button to drop the part onto the board. The part can then be adjusted or moved further into position as needed. Refer to the [Tools to Assist Part Placement](#) section for more information about moving parts and adjusting their placement.

Complete the following steps to place a series of parts on the board using the **Parts Sequencer**:

1. Click an unplaced part in the list (a part with a dark green button). The **Start Placing the Unpositioned Parts** button is activated on the **Parts** tab.
2. Click the **Start Placing the Unpositioned Parts** button.
3. Move the pointer over the board. The selected part is attached to the pointer as you move it over the board.
4. When the part is in position, click to drop it on the board. The next part in the list appears on the mouse pointer.
5. Continue clicking to drop a part and pick up the next until you have placed as many as desired.
6. Right-click to drop the last part or to cancel the action.



Parts that you place this way can then be adjusted or moved as necessary. Refer to the [Tools to Assist Part Placement](#) section for more information about moving parts and adjusting their placement.

Using the Parts Tab for Other Functions

The **Parts** tab of the **Spreadsheet View** can also be used to select a part, lock parts in their current position, find and select a part, or preview a part.

To select a part using the **Parts** tab, double-click the part in the list. The part appears selected in the design.

Complete the following steps to lock and unlock parts:

1. Click a part in the list to select it. To select multiple parts, click one part, hold the Shift key down, then click the last part you want to select. The two parts that you clicked, and any parts listed between them, are now selected.
2. Click the **Lock the Selected Part** button to lock all selected unlocked parts or to unlock the selected locked parts.



Complete the following steps to find a part in the design:

1. Click the part in the list.
2. Click the **Find and Select the Part** button. The view zooms in on the part, which appears selected.



Complete the following steps to preview a part:

1. Click the **Preview** button to toggle the **Preview** function on, if required.
2. Click the part in the list. A picture of the part displays.



You can use the **Parts** tab to place parts that are not on the board but are listed in the **Parts** tab. Parts listed on the tab are either placed on the board or have been imported but not yet placed within the board outline. Parts that are listed in the **Parts** tab but are not on the board are indicated with a dim button, while parts that have been placed on the board are indicated with a bright button.



Note Refer to the [Spreadsheet View](#) section of Chapter 1, [User Interface](#), for information about the other buttons in the **Spreadsheet View**.

Tools to Assist Part Placement

The following sections tell you how to use the tools that Ultiboard provides to help you place parts and other elements on the design.

Working with Ratsnests

A ratsnest is a straight line connection between pads, indicating their connectivity. The ratsnest identifies the pads which should be connected according to the netlist, but which are not yet connected with traces. Because these represent logical connections, and not the physical copper connections referred to as traces in Ultiboard, they are just straight line connections that can overlap parts and other ratsnest lines.

In Ultiboard, ratsnests are represented by colored lines, although they can be dimmed so that they appear gray. They appear by default, exist on their own layer, and can be controlled through the **Information** section of the **Layers** tab in the **Design Toolbox**. Refer to the [Accessing Layers](#) section of Chapter 3, [Setting Up a Design](#), for information about dimming and hiding ratsnests in the **Design Toolbox**.



Tip You can also show or hide individual ratsnests from the **Show Ratsnests** column in the **Nets** tab of the **Spreadsheet View**, and also from the **Net Edit** dialog box. Refer to the [Using the Netlist Editor](#) section of Chapter 5, [Working with Traces and Copper](#), for more information.

The figure below shows the ratsnests as they connect pads in a design without regard to running through parts.

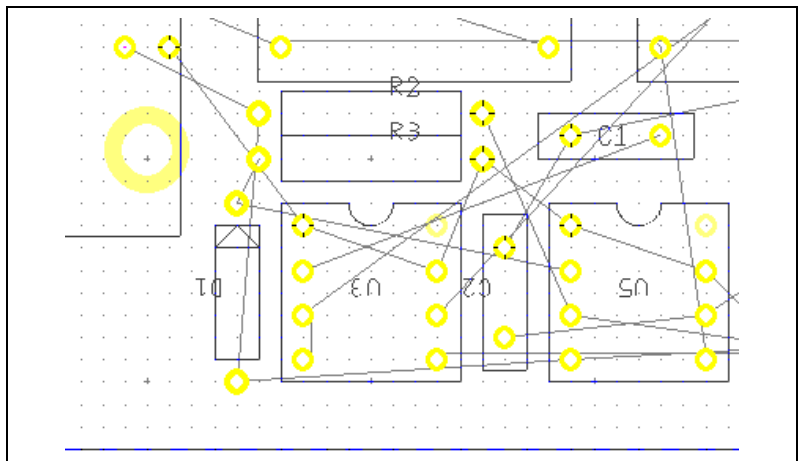

Working with Force Vectors

Force vectors are powerful aids that help you place parts on the PCB. When you place a part manually on the board, you should pay careful attention to the force vectors coming from that part. They allow you to place the part as close as possible to other parts that are attached to the same net.

Try to minimize the ratsnest distances from that part to other pads on the board. Force vectors work by treating the force vector lines coming from each part as if they were vectors, adding them together as a vector sum, and producing a resultant force vector. The resultant force vector has a length and direction. By moving the part in the direction of the force vector, and trying to minimize the force vector length, you are moving the part to a location that results in the shortest possible combination of ratsnest lines.



Note Force vectors are extremely valuable as a guide, but you should not follow them blindly. By the nature of the algorithm, all force vectors have a natural tendency to point toward the center of the board, because all ratsnests would have their shortest connections if all parts were located directly on top of each other in the very center of the board.

In Ultiboard, force vectors are represented by colored lines, although they can be dimmed. They appear by default, but can be controlled through the **Information** section of the **Layers** tab in the **Design Toolbox**. Refer to the [Accessing Layers](#) section of Chapter 3, [Setting Up a Design](#), for more information about dimming and hiding force vectors.

The figure below shows force vectors coming from parts.

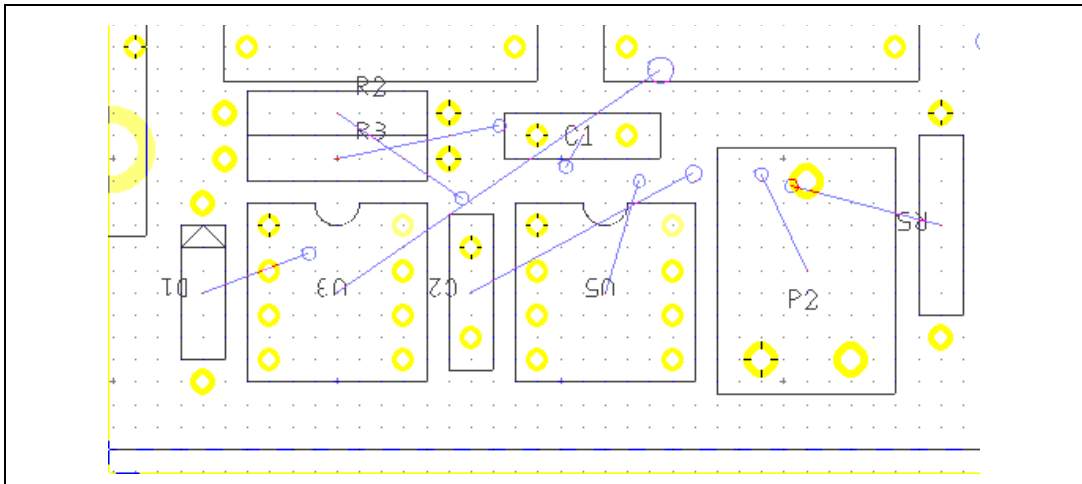

Dragging Parts

To drag a part, click and drag it to the location where you want it placed, and release the mouse button.

To specify the x/y coordinates to which the part is to move, press the * key on the numeric keypad or use the x/y coordinates on the status bar to get a precise reading on the location of the cursor. When you are on the exact location of the part, release the mouse button.

Depending on your settings in the **PCB Design** tab of the **Preferences** dialog box, design rule checking may be enabled while you drag. This monitors for potential short circuits and clearance errors. If the move would cause short circuits or clearance errors, the connections are not made. If connections are lost, they can be restored by putting the part's pad back on the trace to which it belongs (with the same net name).

Rubber Banding

When you move a part that has connected traces, its connections will be maintained—this is called **Rubber Banding**.

Complete the following steps to enable rubber banding:

1. In the **Autorouter Settings** area of the **General** tab of the **Trace Properties** dialog box, select **Trace can be moved**.
2. In the **Part Drag** area of the **PCB Design** tab of the **Preferences** dialog box, select **Re-route after move**.
3. Unlock any locked traces by right-clicking on the trace and selecting **Unlock** from the pop-up that appears.

Shoving Parts

Part shoving allows you to move one part and have Ultiboard automatically push other parts on the board out of the way to create enough available space for the part.



Note Shoving does not work if there is any copper connected to the part.



To toggle the shoving command on and off, choose **Design»Part Shoving**.

Complete the following steps to adjust the shove spacing around a part:

1. Select the part.
2. Choose **Edit»Properties**. The **Part Properties** dialog box for the part appears.
3. Click the **Part** tab. This tab allows you to adjust the distance of part shove spacing.
4. Change the **Part shove spacing** as desired. If you choose **Use Design Rule Defaults**, the setting from the **Design Rules** tab of the **PCB Properties** dialog box is used.
5. In the **Clearances** box, set the following:
 - **To Trace**—Minimum allowable space between the part and traces.

Complete the following steps to enter swapping parameters for the selected part:

1. In the **Swapping** box:
 - **Pin**—Select **Yes**, **No** or **Use Group Settings** from the drop-down list.
 - **Gate**—Select **Internal Gates only** to permit swapping of gates between gates within the same part; **No Swapping** to prohibit gate swapping for this part; **Advanced Swapping** to permit gate swapping between this part and another (both parts must have **Advanced Swapping** selected); **Use Group Settings** to use group swapping options.

To assist you in setting the shove spacing and clearances, the **Dimensions (View Only)** area displays a preview of the selected part with its dimensions displayed:

Complete the following steps to change the dimensions that are displayed in the **Dimensions (View Only)** area:

1. Click on the arrow beside **Dimensions (View Only)** to display the pop-up menu and select/deselect the desired dimensions, as shown in the example below.

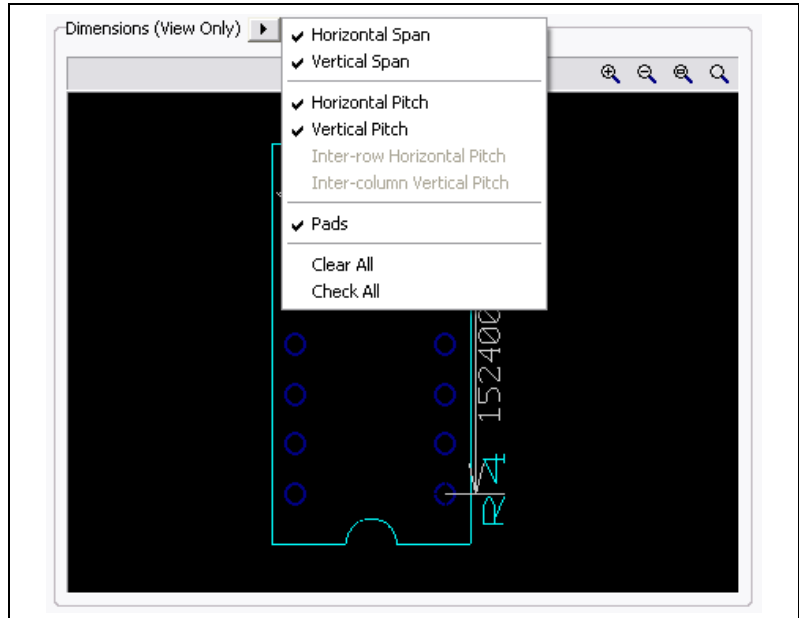

2. Your selections show in the preview area.
3. To manipulate the view of the part, click in the **Dimensions** area and use any of the following:



- **Zoom In** button—Click to zoom in on the part for more detail. You can also press the F8 key.
- **Zoom Out** button—Click to zoom out. Shows less detail and more of the whole part. You can also press the F9 key.
- **Zoom Window** button—Click (or press <F6>) and then drag a rectangle around the portion of the part you want to enlarge. The area inside the rectangle enlarges to fill the **Preview** panel.
- **Zoom Full** button—Click to view the entire part. You can also press <Ctrl-F7>.
- **Mouse Wheel**—If your mouse has a center wheel, you can use it to zoom in and out on the part.
- **Scroll bars**—When the part has been enlarged beyond the borders of the **Preview** area, scroll bars appear that you can move in the usual manner to locate the desired section of a part.

Using Ruler Bars and Guides

Use the ruler bars to place guides on the design, or to measure distances. Elements on the design will snap to the dotted lines representing the guides on the design.



To toggle the ruler bars off or on, choose **View»Ruler bars**.

Complete the following steps to place a ruler guide on the workspace:

1. Click in the ruler bar at the measurement where you want the guide placed, shown in (1) in the figure below. Guides and dotted lines appear as shown in (2) & (3) below.

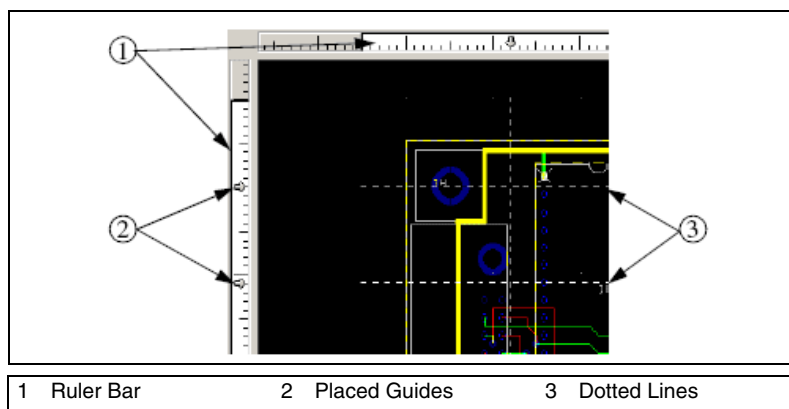

To move a guide, click on it in the ruler bar, and drag it to a new location.



Note If a guide crosses elements on the design, moving the guide will also move the elements.

To remove a guide, right-click on it in the ruler bar, and choose either **Clear** (for a single guide) or **Clear All** (for multiple guides).

To use a guide to measure, click on it in the ruler bar. Measurements from the edge of the window and other guides appear, and change if you move the guide.

Orienting Parts

Parts are placed on the board in a certain orientation, which may not be the orientation in which you need them. You can, however, orient them by rotating them, or by swapping them to another layer.

Complete the following steps to orient a part:

1. Select the part to be oriented.
2. Choose one of the following commands from the **Edit»Orientation** menu:
 - **Flip Horizontal**—Flips the part from left to right.
 - **Flip Vertical**—Flips the part from top to bottom.
 - **90 Clockwise**—Rotates the part 90 degrees clockwise.
 - **90 CounterCW**—Rotates the part 90 degrees counter-clockwise.
 - **Angle**—Rotates the part at an angle that you define.
 - **Swap Layer**—Swaps the selected part to the mirror layer (for example, from **Silkscreen Top** to **Silkscreen Bottom**).

Aligning Shapes and Parts

Shapes and parts can be aligned with other shapes and parts.

Complete the following steps to align shapes and/or parts:

1. Select the elements to be aligned.
2. Choose one of the following commands from the **Edit»Align** menu:
 - **Align Left**—Aligns the left edges of the selected elements.
 - **Align Right**—Aligns the right edges of the selected elements.
 - **Align Top**—Aligns the top edges of the selected elements.
 - **Align Bottom**—Aligns the bottom edges of the selected elements.
 - **Align Center Horizontal**—Shifts the selected elements horizontally so their centers are aligned.
 - **Align Center Vertical**—Shifts the selected elements vertically so their centers are aligned.

Spacing Shapes and Parts

Shapes and parts can be spaced relative to each other on the board.

Complete the following steps to space shapes and/or parts:

1. Select the elements to be spaced.
2. Choose the following commands from the **Edit»Align** menu to space the elements:
 - **Space Across**—Spaces three or more objects beside each other evenly.
 - **Space Across Plus**—Increases horizontal space between two or more objects.
 - **Space Across Min**—Decreases horizontal space between two or more objects.
 - **Space Down**—Spaces three or more objects above each other evenly.
 - **Space Down Plus**—Increases vertical space between two or more objects.
 - **Space Down Min**—Decreases vertical space between two or more objects.

Placing a Group Array Box

A group array box is used to place parts in an array, such as memory chips. You create the array box first and then place the parts.

Complete the following steps to place a group array box:

1. Select **Place»Group Array Box**. The **New group array properties** dialog box displays.
2. Enter the desired **X Spacing** and **Y Spacing** for the array.

Or

If you wish to enter the number of rows and columns instead of the x-y spacing, enable **Enter number of columns and rows**, and enter the desired number of **Columns** and **Rows**.

3. Optionally, enable **Use group centers (will use reference point otherwise)**.
4. Click **OK** and click and drag the mouse to place the array as desired.

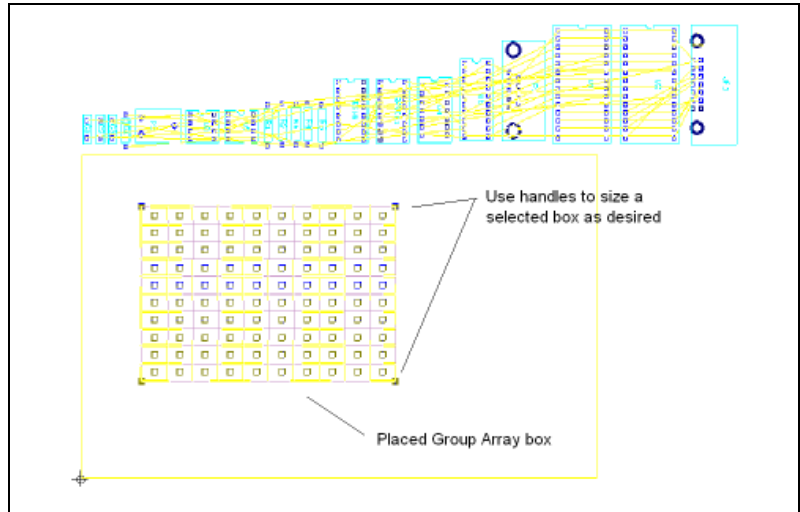

5. Begin selecting and dragging parts. As they are placed, the parts snap to the array.

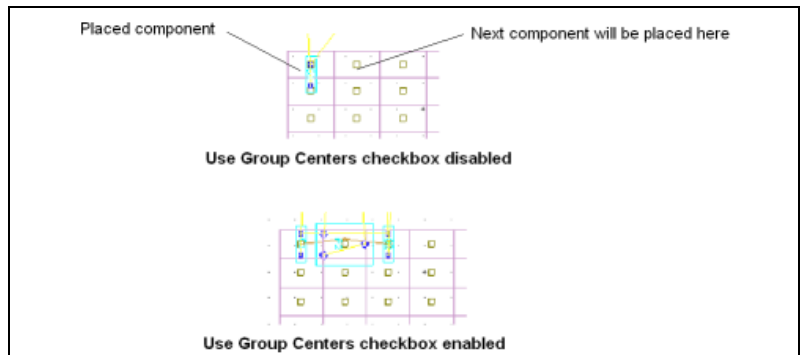

Place the part in the top left cell. The other parts will be placed at the same relative position in the other cells, beginning in the top left row and working to the right.

6. Continue placing parts.

Replicating a Group

The **Group Replica Place** function allows you to automatically apply the relative placement of parts in one group to another group. This is especially useful when duplicating the layout of channels in multi-channel PCBs.

This example uses the following design:

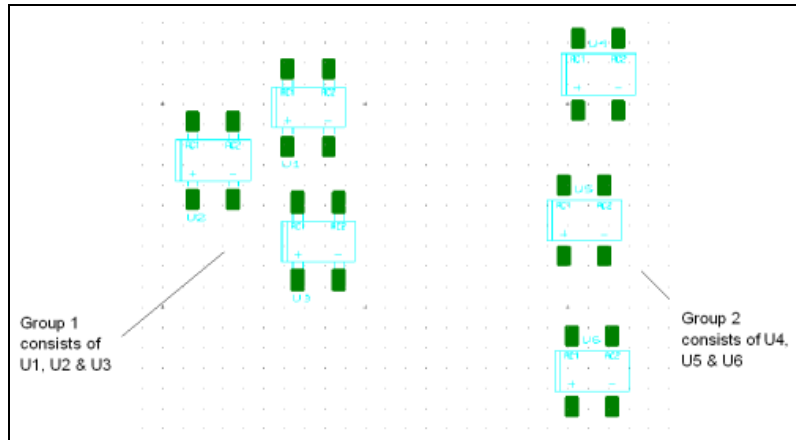

Note Refer to the *Working with the Group Editor* section of Chapter 3, *Setting Up a Design*, for information about group creation.

Complete the following steps to replicate the positioning of a group of parts:

1. Select **Design»Group Replica Place** to display the **Select Groups for Replica Place** dialog box.
2. In the **Primary Group** drop-down list, select the group whose positioning is to be copied.
3. In the **Group to be Replicated** drop-down list select the group whose positioning you wish to change to match the **Primary Group**.
4. Click **OK**. The dialog closes and the **Group to be Replicated** (in this example, group 2) is placed on your cursor in the shape of the **Primary Group**.

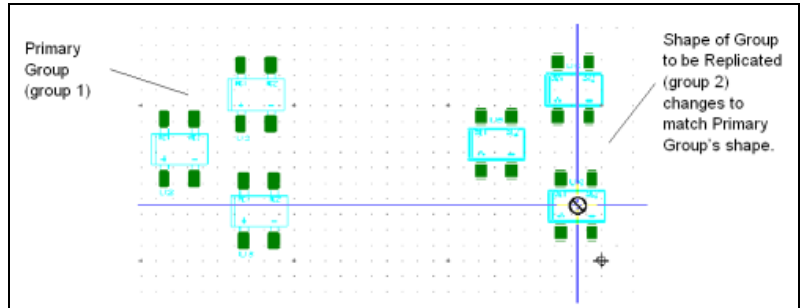

5. Drag your mouse to the desired location and click to place the group.

Unplacing Parts

Complete the following steps to unplace all non-locked parts:

1. Select **Place»Unplace Parts**. A dialog displays asking if you wish to remove any left over copper after the unplace command.
2. Select either **Yes** or **No**. All unlocked parts are removed from the PCB and positioned outside of the board outline.

If you chose **Yes** in the above dialog, the copper that was connected to the unplaced parts is also removed. If you chose **No**, the copper remains in place.

Viewing and Editing Properties

Once a shape or a part has been created, its properties can be viewed and edited. This section explains how to display the property dialog boxes of parts, attributes, and shapes, and what each tells you about the element.

Attributes

All properties dialog boxes for all elements have an **Attributes** tab. Parts are, in general, the only elements that already have attributes, typically including a name, a value, and a shape. For other elements, you can add attributes. All attributes can be changed or added.

In the **Attributes** tab, you can change an attribute's:

- tag (the name for the attribute)
- value (the value of the attribute)
- visibility (invisible, value shows, value and tag show).



Note You can sort attribute information by clicking on the column header.

If you are looking at the attributes of a part that was imported from Multisim, and that part has variants assigned, the tab will also have a variant attribute as shown below.



Note For complete information on variants, refer to the *Multisim help file*.

Complete the following steps to modify or add an attribute:

1. Select the attribute you want to modify and click **Change**. The **Attribute** dialog box appears.

Or

Click **New**.

The **Select layer for attribute** dialog box appears. Select the desired layer and click **OK**. The **Attribute** dialog box appears.

2. Do some or all of the following:
 - Change or set the attribute's tag by choosing from the **Tag** list.
 - Change or set the attribute's value by entering it in the **Value** field.
 - Choose the attribute's **Visibility** by enabling the desired option. Visible attributes are previewed in the **Alignment** area of the dialog box.
 - Use the **Alignment** area to set the attribute's alignment (when visible) relative to the part footprint.
 - Use the **Line Font** area of this dialog box to specify the weight of font used to display the attribute (when visible). Your choices are reflected in the preview area.

Or

If you want to use unicode characters, enable the **Windows Font** radio button, click the **Font** button, and select the desired font from the **Font** dialog box that appears. Please note that "right-to-left" fonts are not supported for copper attributes on the PCB.

- Set the **Height** and **Rotation** of the attribute (when visible). Your choices are reflected in the preview area.
 - Choose the color of the attribute when visible on a specific layer. Choose the layer from the **Layer** drop-down list; the color by clicking **Color**.
3. Click **OK** to save your changes.

To delete an attribute, select it in the **Attributes** tab and click **Remove**.

Viewing and Editing Part Properties



Complete the following steps to view and edit the properties of a part:

1. Select the part.
2. Choose **Edit»Properties**. The part's **Part Properties** dialog box appears, consisting of four tabs: **Attributes**, **Position**, **3D Data**, and **Part**.

The **Position** tab is the default, and appears when you choose **Edit»Properties**. It displays the coordinates of the selected part:

- **X**—The x-axis coordinate.
- **Y**—The y-axis coordinate.
- **Angle (degrees)**—The angle of the part's placement.
- **Board side**—The side of the board on which the part is placed.

The **3D Data** tab allows you to control the properties of the 3D image of the selected part. Any changes to the 3D properties are reflected in the **Preview** area. The **Enable 3D for this object** checkbox must be selected for the part to appear in the 3D view.



Tip Enable the **Automatic preview update** checkbox to have the preview update as changes are made in the **General**, **Material**, **Pins** or **Cylinder** tab. For slower computers, disable the checkbox and click the **Update** button when you wish to refresh the preview.

To rotate the image in the **Preview** area, hold down and drag the left mouse button.

General Tab

Complete the following steps to specify the distance between the part and the board:

1. In the **Height** field, enter the distance to the top of the part from the surface of the board.
2. In the **Offset** field, enter the distance from the part underside to the board.

Complete the following steps to produce the 3D image by projecting the silkscreen information upwards according to the height and offset specified for the part:

1. Enable the **Use 2D Data to create 3D shape** option.

2. Choose the type of object to be created:
 - For a hole, enable the **Hole** option (the hole extends from the **Offset** to the **Height**)—If you want to make the selected part a hole in the 3D view, the part must be completely enclosed (for example, a circle or rectangle) and be contained within another larger object. For example, this could be used to create a notch or dimple in a DIP (dual-in-line package.) These settings should be applied by first editing the part (using either **In-place Edit** or the **Database Manager**) and choosing the object to which the settings apply.
 - For a sphere, enable the **Create Sphere** option and enter a value in the Radius field.

Material Tab

To choose the colors to display for the part, click on the color box beside each of the following field labels, and choose a color from the dialog box that appears:

- **Part**—The color used when the part's face is viewed at right angles to a line from the viewer to the part.
- **Backlight**—The color used on any part face for which the light source is not directly incident.
- **Reflection**—The color used for reflected light. This works in conjunction with the **Surface** setting. The more shine, the more the part will display reflected light.
- **Illumination**—The color used when the part emits light, for example, a light emitting diode.

Pins Tab

To choose the pin model to be used in the 3D rendering, choose from the **Type** list. By default the pin will attach at the mid-point of the body of the part. Enable the **Height** option and enter a height value to use a value other than the default.

Cylinder Tab

Complete the following steps to model a part in a cylindrical package such as a resistor or diode:

1. Enable the **Cylinder between pins** option.
2. If the part is a resistor, enable the **Color code** option.

- To place a band to indicate polarization (for example, for a diode), enable the **Polarization marking** option and choose the pin to mark.
- To set an offset for the cylinder, enable **Use custom cylinder** offsets and enter the **Start Offset** and **End Offset** values.

The **Part** tab is where you adjust the distance of part shove spacing, enter pin and gate swapping settings, and enter trace clearances. Refer to the [Shoving Parts](#) section for more information.

Viewing and Editing Attributes

The attributes associated with a part that are visible on the workspace (typically this is the part's Reference Designator) also have properties. These are made up of three tabs: **General**, **Position** and **Attribute**.

Complete the following steps to view an attribute's properties:

- Select the attribute (for example, the Reference Designator).
- Select **Edit>Properties**. The **Attribute Properties** dialog box appears, containing three tabs: **General**, **Position**, and **Attribute**.



To edit an attribute's display style, use the following from the **Line** area of the **General** tab:

- Style** button—Sets the line style for the attribute's text line.
- Color** button—Sets the attribute's color.
- Width** fields—Set the width of the attribute's text line and the units of measurement.

To edit an attribute's coordinates, angle and layer, use the following in the **Position** tab:

- X**—Sets the X-axis coordinate.
- Y**—Sets the Y-axis coordinate.
- Angle (degrees)**—Sets the angle of the attribute on the PCB.
- Layer**—Sets the layer on which the attribute appears.
- Locked**—Enable to lock the attribute in place.
- Units**—Sets the unit of measurement.

To edit an attribute's visibility, alignment, and so on, use the **Attribute** tab. Refer to the [Attributes](#) section for more information.

Viewing and Editing Shape/Graphics Properties

As with parts and traces, the properties of shapes can be viewed and edited.

Complete the following steps to edit the properties of a shape that you have placed on the design:

1. Select the shape.
2. Choose **Edit»Properties**.

Or

Right-click, and select **Properties** from the context menu that appears. The name of the dialog box that appears varies, depending on the selected shape.



To edit a shape's attributes, use the **Attributes** tab.

Refer to the *Attributes* section for more information about editing properties in the **Attributes** tab.

Depending on the shape/graphic selected, the **General** tab lets you change the width and the clearance of the selected element and define the units of measurement; or change the line style, color and width.

To change the layer on which a shape exists, use the following from the **Position** tab:

- **Layer** drop-down list—Use to select the desired layer.
- **Locked** checkbox—Locks the shape to the layer.

The fourth tab is used to change the selected shape's size. The name and contents of this tab change depending on the shape selected.

Placing Other Elements

This section explains about placing the following elements:

- *Placing Mounting Holes and Connectors*
- *Placing Holes*
- *Placing Shapes and Graphics*
- *Working with Jumpers*
- *Working with Test Points*
- *Working with Dimensions*

Placing Mounting Holes and Connectors

Mounting holes and connectors are placed from the database. Refer to the [Placing Parts from the Database](#) section for more information.

Placing Holes



You can also place holes directly onto the workspace, without using the database, as described below.









1. Select **Place»Hole**. The **Through Hole Pin Properties** dialog box appears.
2. Select the desired **Shape** for the whole. The **Hole Preview** changes accordingly.
If you select **Custom**, the **Get a Part from the Database** dialog box displays, where you must navigate to the desired part in the database.
3. Enter the desired **Units**, **Length**, **Radius** and **Width** for the hole.
4. Optionally, enable **Plated** in the **Drill Option** area if you wish the hole to be plated.
5. Click **OK**. The dialog closes and the hole is placed on the cursor.
6. Move the cursor to the desired location and click to place it on the workspace.
7. You can continue clicking to place more instances of the same hole, or right-click to cancel placement.

Placing Shapes and Graphics

Ultiboard allows you to place various shapes and graphics on your design, and to move them once they have been placed. Depending on your active layer, the set of available shapes and graphics for placement, and what they represent, may differ.

Choose the following commands to place shapes and graphics:

Button	Command	Description
	Place»Line	Left-click two points to draw a line between them. Continue clicking to draw another segment of the same line, or right-click to stop.
	Place»Shape»Ellipse	Left-click two points that define the ellipse's focuses, then move the pointer to define the ellipse's size.

Button	Command	Description
	Place»Shape»Rounded Rectangle	Left-click to define the opposite corners of the rectangle, then move the pointer towards the middle of the rectangle to define the roundness of the corners.
	Place»Shape»Circle	Left-click two points that define the circle's diameter.
	Place»Shape»Pie	Left-click to define two points that define the diameter of the pie, then move the pointer back and forth to define whether the shape looks like a single slice of pie or like a pie with a slice missing.
	Place»Shape»Rectangle	Left-click to define the opposite corners of the rectangle.
	Place»Shape»Polygon	Left-click all points that are to define the polygon, ending with the starting point.
	Place»Graphics»Line	Left-click two points to draw a line between them. Continue clicking to draw another segment of the same line, or right-click to stop.
	Place»Graphics»Arc	Left-click two points to draw an arc between them, then move the pointer to change the degree of arc.
	Place»Graphics»Bezier	Left-click two points to draw a bezier curve between them, then move the pointer to change the degree of arc.

After creating a shape/graphic, right-click to cancel the **Place** command.



Note Shapes and graphics can be moved, oriented, and aligned like parts, and their properties can also be viewed and edited. Use the properties to change the line color, style, and width, and fill color and style if applicable. Refer to the [Viewing and Editing Shape/Graphics Properties](#) section for more information.

Working with Jumpers

Placing Jumpers

Default jumper pin settings are defined in the **PCB Design** tab of the **Preferences** dialog box. The default pad settings are based on the settings defined in the **Pads/Vias** tab of the **PCB Properties** dialog box. They can be manually set to use the annular ring specification or pad diameter settings by setting the properties of the pad when the jumper has been placed on the design.

Complete the following steps to place a jumper:

1. Be sure a copper layer is selected in the **Design Toolbox**.
2. Choose **Place»Jumper**.
3. Move the pointer over the design. The pointer has the first prong of the jumper attached.
4. Click to drop the first prong of the jumper, then move the pointer to where the second prong should be placed.
5. Click to drop the second prong of the jumper.
6. Click to drop the first prong of another jumper, or right-click to cancel the **Place»Jumper** command.



Once both prongs have been placed, jumpers can be moved, oriented, and aligned like parts.

Viewing and Editing Jumper Properties

Complete the following steps to edit the properties of a jumper that you have placed on the design:

1. Select the jumper.
2. Choose **Edit»Properties**.

Or

Right-click, and select **Properties** from the context menu that appears. The **Jumper Properties** dialog appears, consisting of three tabs: **Attributes**, **Line** and **Jumper**.

To edit a jumper's attributes, use the **Attributes** tab. Refer to the [Attributes](#) section for more information.



To control the coordinates for the jumper's starting and ending points, use the following from the **Line** tab:

- **X1**—The X coordinate of the jumper's starting point.
- **X2**—The X coordinate of the jumper's ending point.
- **Y1**—The Y coordinate of the jumper's starting point.
- **Y2**—The Y coordinate of the jumper's ending point.
- **Units**—Units of measurement.

To control the jumper's wire and pin type, use the following in the **Jumper** tab:

- **Diameter**—Sets the wire's diameter.
- **Board Side** buttons—Select the side of the board on which the jumper appears.
- **Pin Type** box—Choose the type of technology for the jumper pins, either **Through Hole Technology** or **Surface Mount Technology**.
- **Units**—Units of measurement.

Working with Test Points

Placing Test Points

Default test point pin settings are defined in the **PCB Design** tab of the **Preferences** dialog box. The default pad settings are based on the settings defined in the **Pads/Vias** tab of the **PCB Properties** dialog box. They can be manually set to use the annular ring specification or pad diameter settings by setting the properties of the pad when the test point has been placed on the design.

Complete the following steps to place a test point:

1. Be sure a copper layer is selected.
2. Choose **Place»Test Point**.
3. Move the pointer over the design. The pointer now has a test point attached.
4. Click to drop the test point on the design.



Test points can be moved, oriented, and aligned like parts. Refer to the [Tools to Assist Part Placement](#) section for more information.

Viewing and Editing Test Point Properties

Complete the following steps to edit a test point's properties:



1. Select the test point and select **Edit»Properties**. The **Testpoint Properties** dialog appears.
2. Select the **Test Point** tab.
3. In the **Wire** area, set the following as desired:
 - **Drill Diameter**
 - **Board Side**—The side of the board on which the test point appears. Select **Top** or **Bottom**.
 - **Rotation**—The angle of rotation of the test point.
4. In the **Pin Type** area, choose either **Through Hole Technology** or **Surface Mount Technology**.
5. Click **OK**.



To edit a test point's attributes, use the **Attributes** tab. Refer to the [Attributes](#) section for more information.

Working with Dimensions

Placing Dimensions

Dimensions can be placed on a silkscreen (top or bottom) layer.



To set dimension parameters, including arrow style, text style, position, orientation, and alignment, choose **Options»Global Preferences** and select the **Dimensions** tab.

Complete the following steps to place a dimension on the board:



1. Be sure you have selected the silkscreen (top or bottom) layer.
2. Choose **Place»Dimension** and choose the type of dimension to be placed:
 - **Standard**—If the dimension is to be placed at an angle.
 - **Horizontal**—If the dimension is to be placed horizontally.
 - **Vertical**—If the dimension is to be placed vertically.
3. Click to define the starting point of the dimension.
4. Move the pointer to the end point of the dimension. Ultiboard measures as you move the pointer.

5. Click to indicate the end point. Ultiboard stops measuring the length, and draws an arrow between your start and end points.
6. Move the pointer to position the stub line, and click when you're done. In the example shown below, the vertical dimension of part RPACK1 has been moved to the outside right of the board outline.

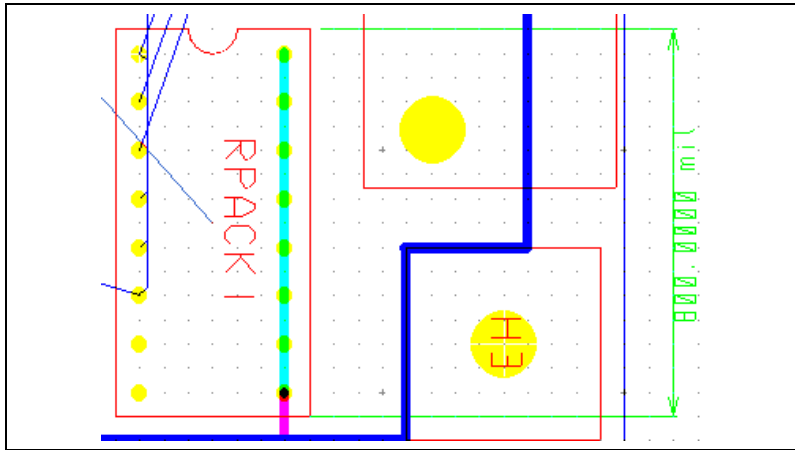

Viewing and Editing Dimension Properties

Dimension properties consist of five tabs: **Attributes**, **General**, **Position**, **Line** and **Dimensions**.

To edit a dimension's properties, select the dimension and select **Edit>Properties**.

To edit a dimension's attributes, use the **Attributes** tab. Refer to the [Attributes](#) section for more information.

To edit a dimension's display style, use the following from the **Line** area of the **General** tab:

- **Style** button—Sets the line style for the dimension's text line.
- **Color** button—Sets the dimension's color.
- **Width** fields—Set the width of the dimension's lines and the units of measurement.

To change the layer on which a dimension exists, use the following from the **Position** tab:

- **Layer** drop-down list—Use to select the desired layer.
- **Locked** checkbox—Locks the dimension to the layer.

To control the coordinates for the dimension's starting and ending points, use the following from the **Line** tab:

- **X1**—The X coordinate of the dimension's starting point.
- **X2**—The X coordinate of the dimension's ending point.
- **Y1**—The Y coordinate of the dimension's starting point.
- **Y2**—The Y coordinate of the dimension's ending point.
- **Units**—Units of measurement.

To control the various aspects of the dimension, adjust the following from the **Dimensions** tab as desired:

- **Units**—Unit of measurement.
- **Stub Length**—Length of dimension's stub.
- **Arrow Style**—The elements in this box set the arrow's characteristics.
- **Text Style**—The **Width** and **Height** of the text. Enable the **Mirror** checkbox to display a mirror image of the dimension.
- **Alignment**—The radio buttons in this box set the dimension's alignment: **Auto**; **Left**; **Center**; **Right**.
- **Position**—The radio buttons in this box set the position of the dimension: **Outside**; **Inside**; **Above**; **Over**; **Below**.
- **Orientation**—The radio buttons in this box set the orientation of the dimension: **Auto**; **Horizontal**; **Vertical**.

Placing Parts from the Database

Complete the following steps to place parts from the database:



1. Choose **Place»From Database**. The **Get a Part from the Database** dialog box displays.
2. In the **Database** panel, expand the categories until you find the category where the part is. The parts appear in the **Available Parts** panel.
3. In the **Available Parts** panel, select the part you need. The part appears in the **Preview** panel. To manipulate the view of the part, click in the **Preview** area and use any of the following:
 - **Show Dimensions** button—Displays selected dimensions of the part (unit of measure is set from the **Units** drop-down list). To change the displayed dimensions, click on the down-arrow beside the **Show Dimensions** button.



- **Zoom In** button—Click to zoom in on the part for more detail. You can also press the F8 key.
 - **Zoom Out** button—Click to zoom out. Shows less detail and more of the whole part. You can also press the F9 key.
 - **Zoom Window** button—Click (or press <F6>) and then drag a rectangle around the portion of the part you want to enlarge. The area inside the rectangle enlarges to fill the **Preview** panel.
 - **Zoom Full** button—Click to view the entire part. You can also press <Ctrl-F7>.
 - **Mouse Wheel**—If your mouse has a center wheel, you can use it to zoom in and out on the part.
 - **Scroll bars**—When the part has been enlarged beyond the borders of the **Preview** area, scroll bars appear that you can move in the usual manner to locate the desired section of a part.
4. Click **OK**. The **Get a part from the Database** dialog box disappears, and the **Enter Reference Designation for Part** dialog box appears.
 5. Enter the part's **REFDES** (Reference Designator) and **Value** (for example, 20 ohms for a resistor) and click **OK**.
 6. Move the pointer over the board. The selected part is attached to the pointer.
 7. When the part is in position, click to drop it on the board.
 8. Optionally, adjust or move the part further into position. Refer to the *Tools to Assist Part Placement* section for more information.



Tip When you place parts from the database you must add them to the netlist. Refer to the *Using the Netlist Editor* section of Chapter 5, *Working with Traces and Copper*, for more information.

Editing Parts and Shapes

Editing a Placed Part (In-Place Edit)

In-place part editing lets you add, delete, or change a part and the items that make it up. You can add, delete, or move pads, change or move the lines that define a part, or place new shapes or lines in the part.

Complete the following steps to use **In-Place Edit** on a part:



1. Select the part and choose **Edit»In-Place Part Edit**.

An editing window opens, showing the selected part. The window also shows the surrounding area of the board and the other parts in a dimmed view, which cannot be edited. In the example shown below, the selected part U2 is bright, while the unselected parts are dimmed.

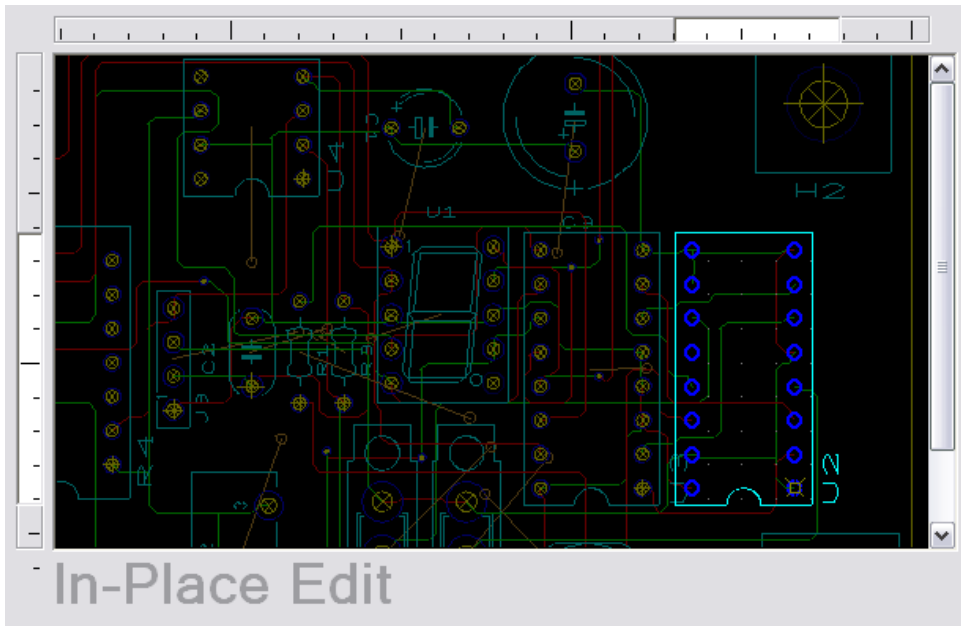

Note Refer to the *Colors Tab* section of Chapter 1, *User Interface*, for information about changing the degree of dimming displayed on the parts that are not being edited.



2. Edit the part using the **Place** and **Draw** tools. Refer to the *Toolbars* section of Chapter 1, *User Interface*, for more information.
3. To add a pin, choose **Place»Pins**. The **Place Pins** dialog box displays.

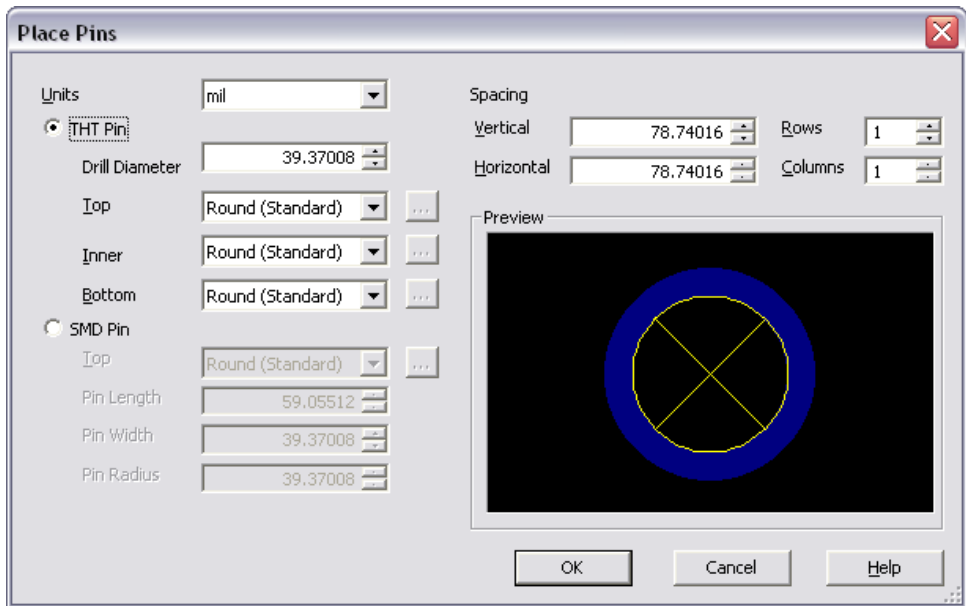

4. Indicate the pad type (THT or SMD) and its dimensions and spacing. Changes appear in the **Preview** panel. When you have made the necessary settings, click **OK**. The pad is attached to the pointer. Click on the part to place it.
5. When finished, choose **Edit»In-Place Part Edit** again to end the **In-Place Edit** function. The part appears with its changes.



Note You can save your edited part in the database for future use. Refer to the [Adding Parts using the Add Selection to Database Command](#) section for more information.

Editing a Polygon

A vertex is a point of a polygon. You can add or remove vertices from polygons, whether copper or non-copper.

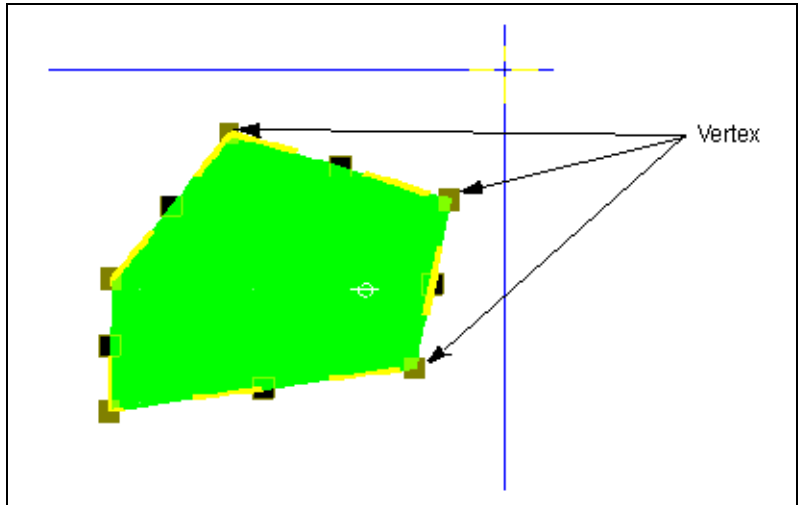

Complete the following steps to add a vertex to any line segment of a polygon:

1. Select the line (a selected line segment will have filled selection boxes while the other selection boxes in the polygon will be open).
2. Select **Edit»Vertex»Add Vertex**. A vertex is added in the middle of the segment.

You can now move that vertex to change the shape of the polygon.

Complete the following steps to remove a vertex:

1. Click on the point to be removed.
2. Choose **Edit»Vertex»Remove Vertex**. The vertex is removed, and the vertices on either side are joined by a straight line.

Complete the following to change the size of a design's vertices:

1. Edit the **Minimum control point size** field in the **General** tab of the **Preferences** dialog box. Refer to the [General Tab](#) section of Chapter 1, [User Interface](#), for more information.

Viewing and Editing Through Hole Pin Properties



Complete the following steps to edit through hole pin properties:

1. Select the desired through hole pin and select **Edit»Properties**.
2. The **Through Hole Pin Properties** dialog box appears, consisting of five tabs: **Attributes**, **General**, **Pad**, **Layer Settings** and **Thermal Relief**.

To edit a through hole pin's attributes, use the **Attributes** tab. Refer to the [Attributes](#) section for more information.

To edit a through hole pin's display style, use the following in the **General** tab:

- **X**—The x-axis coordinate.
- **Y**—The y-axis coordinate.
- **Net**—The net this through hole pin is on (read-only)
- **Angle (degrees)**—The angle for the pin.
- **Board side**—Select the **Top** or **Bottom** radio button to set the side of the board on which the through hole pin resides.
- **Units**—The unit of measurement.
- **To Trace**—The minimum space between the through hole pin and any trace.

To control the shape and size of the through hole pin, use the **Pad** tab . The preview in the **Shape** area of this tab shows the pad as it was created; the **Selection Preview** shows how the pad appears on the workspace.

- **Shape** box—Choose options to control the shape of the through hole pin. Shape settings can be set differently for each layer if desired.
- **Pad Size** box—Choose the appropriate option and, where necessary, value for the pad size.
- **Solder Mask** box—Choose the solder mask layer where the pad appears.
- **Hole** box—Choose the hole type. If you choose **Advanced Hole**, and click **Properties**, the **Through Hole Pin Properties** dialog appears. Refer to the [Placing Holes](#) section for more information.

Use the **Layer Settings** tab to add copper rings to through-hole pins or vias on specified layers

1. Enable the **Copper Ring** checkbox for layers to which you wish to add a connection to the through-hole pin or via.
2. Enable the **Allows Autorouting** checkbox for the desired layers. This option is for autorouting only. It does not affect Netlist and DRC checks. You cannot allow autorouting for layers that do not have a copper ring.
3. Optionally, click **Define Drill Settings** to select the lamination that is to be used for the through-hole pin or via.

Use the **Thermal Relief** tab to choose what type of thermal relief the pin will use when connecting to a copper area or power plane.

1. Select the desired thermal relief in the **Type** box.
2. Select the desired width of the spokes in the thermal relief from the **Spoke Width** drop-down list.

Viewing and Editing SMT Pin Properties



Complete the following steps to edit SMT (Surface Mount Technology) properties:

1. Select the desired SMT pin and select **Edit>Properties**.
2. The **SMT Pin Properties** dialog box appears, consisting of five tabs: **Attributes**, **General**, **Pad**, **Thermal Relief**, and **Pin Neck**.

To edit an SMT pin's attributes, use the **Attributes** tab. Refer to the [Attributes](#) section for more information.

To edit an SMT pin's display style, use the following options in the **General** tab:

- **X**—The x-axis coordinate.
- **Y**—The y-axis coordinate.
- **Net**—The net this SMT pin is on (read-only)
- **Angle (degrees)**—The angle for the pin.
- **Board side**—Select the **Top** or **Bottom** radio button to set the side of the board on which the SMT pin resides.
- **Units**—The unit of measurement.
- **To Trace**—The minimum space between the SMT pin and any trace.

Use the **Pad** tab to control the **Shape** and size of the through hole pin. The **Pad Preview** on this tab shows the SMT pin as it was created, the **Selection Preview** shows how the SMT pin appears on the workspace.

Use the **Thermal Relief** tab to choose what type of thermal relief the SMT pad will use when connecting to a copper area or power plane.

1. Select the desired thermal relief in the **Type** box.
2. Select the desired width of the spokes in the thermal relief from the **Spoke Width** drop-down list.

Use the **Pin Neck** tab to enter dimensions for the pin necks.

Searching For and Replacing Parts

Ultiboard allows you to search for parts in two ways:

- Searching for parts in open designs. This method tells you if a specific part exists in all of the designs that are currently open.
- Locating a part in a design. This method finds a specific part in the design where you are currently working, and zooms in on the part.

You can also replace a part with one from the database.

Searching for Parts in Open Designs

To find out if a part exists in the open designs, you can search for it with the **Edit»Find** command. While this command works much like a Find function in other applications, it also allows you to search for a part by name, number, shape, value, or by all variables.

Complete the following steps to find out if a part exists in the open designs:



1. Choose **Edit»Find**. The **Find** dialog box opens.
2. Enter your search criteria from the selection below:
 - **Find what**—Enter all or part of the a RefDes, or variables that define parts: name, number, shape, or value.
 - **Find special**—Select one of **ALL TAGS**, **NUMBER**, **REFDES**, **VALUE**.
 - **Match case**.
 - **Match whole word only**.
3. Click **Find**. The search results appear in the **Results** tab of the **Spreadsheets View**.
4. Double-click an item in the **Results** tab of the **Spreadsheets View** to zoom in and display that item in the workspace.

Locating a Part in a Design

To help you find specific parts in the open design, use the **Parts** tab.

Complete the following steps to find a part in the design:

1. Click the **Parts** tab in the **Spreadsheets View**.
2. Click the part in the list.
3. Click the **Find and Select the Part** button above the list of parts. The view zooms in on the part, which appears selected.



Replacing Parts



Complete the following steps to replace a part on the design with a part from the database:

1. Select the part.
2. Choose **Tools»Change Shape**. The **Get a Part from the Database** dialog box opens.
3. In the **Database** panel, expand the categories until you find the category where the part is. The parts appear in the **Available Parts** panel.
4. In the **Available Parts** panel, select the part you need. The part is previewed in the **Preview** panel when it is selected.
5. Click **OK** to replace the selected part on the design with the part you chose from the database.

Cross-probing

Cross-probing is the ability to highlight a selected part or group of parts in Multisim.

Complete the following steps to perform cross-probing:

1. Launch Multisim and open the file that corresponds to the design you have open in Ultiboard.
2. In Ultiboard, select the parts that you wish to highlight in Multisim.
3. Select **Tools»Highlight Selection in Multisim**. The parts are highlighted in Multisim.

Creating New Parts

You can design your own parts if necessary, either through the **Database Manager**, or using the **Part Wizard**.

Using the Database Manager to Create a Part



Complete the following steps to create a part:

1. Choose **Tools»Database»Database Manager**.
2. Click the **New** button above the **Parts** panel. The **Select the part you want to create** dialog box appears.



3. Select the type of part you want to create: a net bridge, custom pad shape, PCB part or CAD part and click **OK**. The **Edit mode** window opens.
4. Design your part using the **Place** and **Draw** tools. Refer to the [Toolbars](#) section of Chapter 1, [User Interface](#), for more information.
5. To add a pin to a PCB part or net bridge, choose **Place»Pins**. The **Place Pins** dialog box opens.
Indicate the pad type (THT or SMD), its dimensions and spacing, and click **OK**. The pin is attached to the pointer. Click on the part to place it.
6. When finished designing the part, choose **File»Save to database as**. The **Insert the selected Item(s) into the database** dialog box appears, with the cursor in the **Existing Parts** field.
7. Type a name for the new part. The name must be unique.
8. Click **OK**. The **Insert the selected Item(s) into the database** dialog box disappears, but the edit mode window stays visible.
The part can be placed from the database. Refer to the [Placing Parts from the Database](#) section for more information.
9. Click the design in the **Projects** tab of the **Design Toolbox** to return to the design screen.

Using the Part Wizard to Create a Part

The **Part Wizard** steps you through the process of creating a part.

Complete the following steps to use the **Part Wizard**:



1. Choose **Tools»Part Wizard**. Step 1 of the **Part Wizard** appears.
2. Choose one of the following:
 - **THT**—Through Hole pin technology.
 - **SMT**—Surface Mount pin technology.
3. Click **Next** to display step 2 of the wizard.

If you chose **TH** in step 1 of the wizard, the **Package Type** choices shown below appear:

- **DIP (Dual in Line Package)**
- **PGA (Pin Grid Array Package)**
- **SPGA (Staggered Pin Grid Array Package)**
- **SIP (Single in Line Package)**
- **ZIP (Zigzag in Line Package)**

If you chose **SMT** in step 1 of the wizard, the **Package Type** choices shown below appear:

- **SOT (Small Outline Transistor)**
 - **TO (Transistor Outline)**
 - **SO-Gullwing (Small Outline, SOIC, SOP, TSSOP)**
 - **SO-J (Small Outline J Lead)**
 - **PLCC (Plastic Leaded Chip Carrier Package)**
 - **QFP (Quad Flat Package)**
 - **BGA (Ball Grid Array Package)**
 - **SBGA (Staggered Ball Grid Array Package)**
 - **SIP (Single in Line Package)**
 - **ZIP (Zigzag in Line Package)**
4. Choose the desired **Package Type** and click **Next** to display step 3 of the wizard.

The following **Package Dimension** choices appear:

- **Units**—Select the unit of measure from the drop-down list.
- **X**—The “x” dimension of the part (displayed on the preview).
- **Y**—The “y” dimension of the part (displayed on the preview).
- **3D Height**—The height of the the part, as displayed in the 3D view.
- **3D Offset**—The distance between the PCB and the bottom of the part.
- **Corner Cutoff - Notch (A)**—The size of the notch on the part.
- **Corner Cutoff - Left Top**—Places the notch on the left top of the part.
- **Corner Cutoff - Right Top**—Places the notch on the right top of the part.
- **Corner Cutoff - Left Bottom**—Places the notch on the left bottom of the part.
- **Corner Cutoff - Right Bottom**—Places the notch on the right bottom of the part.
- **Circle Pin 1 Indicator**—Enable to show a circle around pin 1 of the part.

- **Diameter**—The diameter of the circle around pin 1 of the part. Becomes active when **Circle Pin 1 Indicator** is selected.
- **Distance from Edge**—The distance between the circle around pin 1 and the edge of the part. Becomes active when **Circle Pin 1 Indicator** is selected.



Note Depending on the **Package Type** selected in step 3 of the wizard, some settings may not be available.

5. Make the desired **Package Dimension** settings and click **Next** to display step 4 of the wizard.

The following 3D settings appear:

- **Shininess**—Use the slider to adjust the shininess of the part when seen in the 3D view.
- **Colors**—Click on the button beside each of the following parameters and select the desired color: **Background Light**; **Direct Light**; **Reflection Light**; **Emit Light**.

6. Make the desired 3D settings and click **Next** to display step 5 of the wizard. The options available will depend on whether you selected **THT** or **SMT** in step 1 of the wizard.

If you chose **THT**, the following options appear:

- **Units**—The unit of measure for the settings.
- **Drill Hole - Diameter**—Diameter of the through-hole pin's drill hole. This is displayed in the lower right preview (dimension "D").
- **Shape area**—Use to set the shape for the **Top**, **Bottom** and **Inner** sections of each pad. For each of these sections of the pad, you can choose individual shapes: **Round**; **Square**; **Rounded Square**; **Custom**. As you make your selections, they are reflected in the lower right preview area, which displays the currently active settings. If you choose **Custom**, the **Get a Part from the Database** dialog box appears, where you can select any previously-created pad shapes. Refer to the [Using the Database Manager to Create a Part](#) section for more information.
- **Pad Size**—Select **Use Design Rules** if you wish to use the default values set up in the **PCB Properties** dialog box. Otherwise, enable **Pad Diameter** and **Annular Ring** and enter the desired values.
- **Settings Management**—This is useful if you wish to have different pad types and dimensions on the same part footprint.

Click **Add** to create a new pad and then change the settings that are detailed above. You can create as many of these as you like, and choose between them by clicking on the “<<” and “>>” buttons. Remove any undesired pad types by clicking **Remove**. To change a pad type on the part, use the “<<” and “>>” buttons to select the desired pad in the lower right preview area and click on the pin you wish to change in the upper right part preview. The part preview changes to reflect the new pad information.



Note Pad types that you make using the **Add** button are for the convenience of adding unique pads to the current multiple pin part. If you create another part, these will not be accessible from the **Settings Management** area.

If you chose **SMT**, the following options appear:

- **Circular**—Enable to make the pads circular and enter the desired **Diameter**. The changes are displayed in the lower right preview area.
- **Rectangular**—Enable to make the pads rectangular and enter the desired **X** and **Y** dimensions. The changes are displayed in the lower right preview area.
- **Rounded Corner**—Enable to make pads with rounded corners and enter the desired **Rounded rectangle X**, **Rounded rectangle Y** and **Corner Radius** settings. The changes are displayed in the lower right preview area.
- **Custom Pad**—Enable to display the **Get a Part from the Database** dialog box, where you can select any previously-created pad shapes. Refer to the [Using the Database Manager to Create a Part](#) section for more information.
- **Settings Management**—This is useful if you wish to have different pad types and dimensions on the same part footprint. Click **Add** to create a new pad and then change the settings that are detailed above. You can create as many of these as you like, and choose between them by clicking on the “<<” and “>>” buttons. Remove any undesired pad types by clicking **Remove**. To change a pad type on the part, use the “<<” and “>>” buttons to select the desired pad in the lower right preview area and click on the pin you wish to change in the upper right part preview. The part preview changes to reflect the new pad information.



Note Pad types that you make using the **Add** button are for the convenience of adding unique pads to the current multiple pin part. If you create another part, these will not be accessible from the **Settings Management** area.

7. Make the desired pad settings and click **Next** to display step 6 of the wizard.

The following **Pins** information appears:

- **Units**—The unit of measure.
- **Number of Pins**—The number of pins in the part.
- **Distances - Between pins (A)**—The “A” distance between pins as shown on the preview.
- **Distances - Between rows (B)**—The “B” distance between rows as shown on the preview.



Note Distances information changes depending on the **Package Type** you selected in step 2 of the wizard.

8. Make the desired pin settings and click **Next** to display step 7 of the wizard.

The following **Pad Numbering** information appears:

- **Type of Pad Numbering**—Available options appear here. Many parts only have the **Numeric** option; others are **alpha-numeric**; **numeric-alpha**.
- **Direction of Pad Numbering**—Displays the available options for the selected package type.
- **Start Number Offset**—Offsets the starting position of the pad numbers.

9. Make the desired **Pad Numbering** settings and click **Finish**.
10. The wizard closes, and the part is available for further editing in the **Footprint edit mode** using the **Place** and **Draw** tools. Refer to the [Toolbars](#) section of Chapter 1, [User Interface](#), for more information.
11. When you are finished, choose **File»Save to database as**. The **Insert the selected Item(s) into the Database** dialog box appears, with a cursor in the **Existing Parts** field.
12. Type a name for the new part. The name must be unique.
13. Click **OK**. The **Insert the selected Item(s) into the Database** dialog box disappears, but the **Footprint edit mode** screen stays visible.

The part can be now placed from the database. Refer to the [Placing Parts from the Database](#) section for more information.

To return to the design screen, click the design in the **Projects** tab of the **Design Toolbox**.

Managing the Database







The **Database Manager** is where you add, organize, view, create, and manage the parts that Ultiboard stores in its database.









To open the **Database Manager**, choose **Tools»Database»Database Manager**.

There are three panels in the **Database Manager**:

- The **Database** panel, which lists the databases and their sub-categories. The **Database** panel contains the following buttons. Refer to the [Working with Database Categories](#) section for more information.

Button	Description
	New button. Creates a new database category or sub-category.
	Add button. Use to add parts to either the User or Corporate database. Refer to the Adding Parts using the Database Manager section for more information.
	Delete button. Deletes a database category or sub-category.
	Rename button. Renames a database category or sub-category.
	Copy button. Copies a database category or sub-category.
	Move button. Moves a database category or sub-category.

- The **Parts** panel, which lists the parts in the selected sub-category. The **Parts** panel contains the following buttons to help you work with the parts:

Button	Description
	New button. Creates a new part. Refer to the <i>Using the Database Manager to Create a Part</i> section for more information.
	Edit button. Edits a part. Refer to the <i>Editing a Placed Part (In-Place Edit)</i> section for more information.
	Delete button. Deletes a part.
	Rename button. Renames a part.
	Copy button. Copies a part.
	Move button. Moves a part.

- The **Preview** panel, which allows you to preview the part you selected in the **Parts** panel. To manipulate the view of the part, click in the **Preview** area and use any of the following:



- **Show Dimensions** button—Displays selected dimensions of the part (unit of measure is set from the **Units** drop-down list). To change the displayed dimensions, click on the down-arrow beside the **Show Dimensions** button.
- **Zoom In** button—Click to zoom in on the part for more detail. You can also press the F8 key.
- **Zoom Out** button—Click to zoom out. Shows less detail and more of the whole part. You can also press the F9 key.
- **Zoom Window** button—Click (or press <F6>) and then drag a rectangle around the portion of the part you want to enlarge. The area inside the rectangle enlarges to fill the **Preview** panel.
- **Zoom Full** button—Click to view the entire part. You can also press <Ctrl-F7>.

- **Mouse Wheel**—If your mouse has a center wheel, you can use it to zoom in and out on the part.
- **Scroll bars**—When the part has been enlarged beyond the borders of the **Preview** area, scroll bars appear that you can move in the usual manner to locate the desired section of a part.

In addition, there are two functions that allow you to control the information that appears in the **Database** and **Parts** panels:

- The **Filter** drop-down list allows you to display only PCB parts, custom PAD shapes, net bridges or CAD parts in the **Parts** panel.
- The **Show subtree contents** checkbox lets you control the display of the subtree contents from the **Database** panel.

Working with Database Categories

To make parts in the database easier to locate, the database organizes them into categories and sub-categories. You can expand and collapse the categories and sub-categories in the **Database Manager** just as you would in similar Windows applications: click the plus (+) to expand a category or subcategory, and click the minus (-) to collapse it.

While there are default categories and sub-categories, you can create new ones if necessary. These are stored in the **User Database**.

You can copy any database category and its contents to another category or sub-category. The sub-categories that appear by default cannot be deleted, renamed, or moved, but you can delete, rename, or move the ones that you have added.

Complete the following steps to create a new database category:

1. Open the **Database Manager**.
2. In the **Database** panel, click the root or a subcategory to indicate where the new category belongs. The new category will be created as a sub-category of the item you select.
3. Click the **New** button above the **Database** panel. A new category is created with **New Object-Group** as the name.
4. Type a name for the new category and press ENTER.



Complete the following steps to copy a database category:

1. In the **Database** panel, select the category to be copied.
2. Click the **Copy** button above the **Database** panel. The **Select Destination in Database** dialog box appears.



3. Select the category or sub-category where the category is to be copied. The copied category will go under the item you select.
4. Click **OK**. The category is copied to the location you specified, and the **Select destination in database** dialog box disappears.

Complete the following steps to delete a database sub-category:

1. In the **Database** panel, select the sub-category to be deleted.
2. Click the **Delete** button above the **Database** panel. You are prompted to confirm the deletion. The sub-category disappears from the list.



Complete the following steps to rename a database sub-category:

1. In the **Database** panel, select the sub-category to be renamed.
2. Click the **Rename** button above the **Database** panel. The name of the sub-category is highlighted.
3. Change the name as desired.



Complete the following steps to move a database category or sub-category:

1. In the **Database** panel, select the category or sub-category to be moved.
2. Click the **Move** button above the **Database** panel. The **Select destination in database** dialog box appears.
3. Select the category or sub-category where the category is to be moved. The moved category will go under the item you select.
4. Click **OK**. The category is moved to the location you specified, and the **Select destination in database** dialog box disappears.



Adding Parts to the Database

Parts that appear on a design but do not exist in the database can be added to the database two ways:

- By using the **Database Manager**.
- By using **Tools»Database»Add Selection to Database**.

Adding Parts using the Database Manager

Complete the following steps to add parts from the design to the database using the **Database Manager**:

1. In the **Database** panel, select the category (within the **User** or **Corporate Database**) you want to add the part to.
2. Click the **Add** button above the **Database** panel. The **Add new parts to database** dialog box appears.



If you selected one or more parts on the design before opening the **Database Manager**, the **Current selection as one part** option is selected at the top of the dialog box.

Otherwise, the **Complete design contents** option is selected. The dialog box lists the parts in the design along with a preview of each.

3. Select the desired **Target Database** (where the parts will be saved).
4. Select the part(s) to be added.



To select all parts, click the **Select All Items** button (or press <Ctrl-A>).

To deselect all parts, click the **Unselect All Items** button.



5. To rename a part, highlight it and click the **Rename** button. The part name must be unique regardless of the database category you want to place it in.



6. Click **OK** to add the part(s) to the database.

Adding Parts using the Add Selection to Database Command

To add a part to the database using the **Add Selection to Database** command:

1. In the design, select the part to be added. You can also select multiple parts that will be added as a group.
2. Choose **Tools»Database»Add Selection to Database**. The **Insert the Selected Items into the Database** dialog box opens, with the part illustrated in the **Preview** panel, and the part's name in the **Existing parts** field (unless multiple parts were selected).
3. If necessary, enter or edit the part's name. The part name must be unique for the selected database, regardless of the category it will be stored in.
4. Select the database category or sub-category where the selected part is to be kept.
5. Click **OK**.





Note If you selected multiple parts, you can save them to the database as one item. When a part that has been saved to the database in this manner is placed on the workspace, it will become separate items again, including any parts and traces that were in the original selection.

Merging and Converting Databases

You can merge parts from one database into another or convert parts that you created in your old **User Database** to Ultiboard 10 format.

Details follow.

Merging Databases

You can merge parts from one database into another. For example, you may have created a number of parts on your home computer that you wish to merge into a part database on your office computer.

Complete the following steps to merge databases:

1. Select **Tools»Database»Merge Database**. The **Database Merge** dialog box appears.
2. Click on **Select a Component Database Name** in the **Source Database** area. The **Select a Component Database Name** dialog box displays.
3. Navigate to the location of the database that you wish to merge (your source database) and select the type of database that you wish to merge in the **Files of type** drop-down list:
 - **User (Usrcomp_s_*.usr)**—User database.
 - **Corporate (Cpcomp_s.prj)**—Corporate database.
4. Highlight the source database file (the one you wish to merge) and click **Open**. You are returned to the **Database Merge** dialog box.
5. Select the **Target Database**. This is the database into which you will merge the parts from your **Source Database**.
 - **Corporate Database**—Parts from the source database will be merged into the **Corporate Database**.
 - **User Database**—Parts from the source database will be merged into the **User Database**.

6. Click **Start**. A dialog box displays with the following options:
 - **Auto-Rename**—Parts will be saved with modified names in the new database.
 - **Overwrite**—Parts will overwrite new parts with the same name.
 - **Ignore**—Parts with the same name will not be merged.
7. Select the desired option and click **OK**. The parts from the source database are merged into the target database, based on the option selected above.
8. Click **Close** to close the **Database Merge** dialog box.

Converting Databases

If you are a user of an earlier version of Ultiboard, your **User Database** and **Corporate Database** must be converted to Ultiboard 10 format if you wish to use their components in Ultiboard.



Note The option to convert the **Ultiboard Master** database is not available, as a new **Ultiboard Master** database is loaded when you install Ultiboard.

Complete the following steps to update your databases to Ultiboard 10 format:

1. Select **Tools»Database»Convert Database**. The **Select Type** dialog box appears.
2. Select either **Convert V6/V7 database** or **Convert V8/V9 database** and click **OK**. The **Convert Database** dialog box appears.
3. Click **Select a Database File Name** in the **Source Database** area. The **Select a Database File Name** dialog box displays.
4. Navigate to the location of the database that you wish to convert (your source database), select the database type in the **Files of type** drop-down list, select the database and click **Open**. You are returned to the **Convert Database** dialog box.
5. Select the **Target Database**. This is the database into which you will merge the converted parts from your **Source Database**.
 - **Corporate Database**—Parts from the source database will be converted and added to the **Corporate Database**.
 - **User Database**—parts from the source database will be converted and added to the **User Database**.
6. Click **Start**. The **Duplicate Part Name** dialog box displays.

7. Select one of the following options:
 - **Auto-Rename...**—Imports and automatically renames the duplicate parts.
 - **Overwrite...**—Replaces the Ultiboard 10 parts with your old parts.
 - **Ignore...**—Does not import parts with duplicate names.
8. Click **OK**.

Working with Traces and Copper

The following sections describe how to work with traces and other copper elements in Ultiboard.

Some of the described features may not be available in your edition of Ultiboard. Refer to the NI Circuit Design Suite Release Notes for a list of the features in your edition.

Placing Traces

You can place the traces on the board by using one of the methods explained here, or by using the methods described in Chapter 7, *Autorouting and Autoplacement*.

The manual methods used to place traces are:

- **Manual trace**—This method allows you the maximum control in trace placement. You select the pads and vias to be connected, and dictate the path the trace takes to the next connection.
- **Follow-me router**—This method allows you to select the next pad or via to be connected by having Ultiboard follow your mouse movement as it places a trace. Ultiboard routes the resulting trace around most obstacles.
- **Connection Machine**—This method connects two pads or vias with a trace that is automatically routed around obstacles.

All methods of placing traces support the ratsnest selection method. This method starts the trace when the ratsnest is selected and auto-connects the trace to the nearest destination pad.

All methods except **Connection Machine** support continuous trace placement; when a trace is placed between two pads, the trace placement will continue from the last pad connected.

As you place a trace, and before you click to place it, you can always remove a segment by backing up over it. Each time you click while placing a manual trace, or each time a **Connection Machine** trace changes direction, a separate segment of that trace is created. When performing

operations on traces, be sure to select either the appropriate segment or, if you wish, the whole trace.

Clearance is the distance from the edge of the board and around pads and traces that is to be kept free of any other elements. Trying to run a trace through a clearance, or trying to place a part so that a pad is put within a clearance, for example, results in an error. The board outline clearance is defined in the **PCB Properties** dialog box. Clearances for other copper elements are defined in the **General** tab of the element's properties. Refer to the [Viewing and Editing Copper Properties](#) section for more information.



To view clearances, choose **View»Clearances**. The clearances are shown as fine blue lines around pads and traces.

Working with Traces

Ultiboard's default trace measures 10 mil wide and has a clearance of 10 mil. Clearances are measured from the outside edge of an object: a 10 mil trace with a 5 mil clearance would measure 20 mil across from edge to edge (5 mil clearance on one side, the 10 mil trace, and 5 mil clearance on the other side).

Placing a Trace: Manual Method

When you place a trace manually, you click pads and vias, and you must also click the trace's pivot points. This means that you have the most control over where the trace lies, but you must avoid placing the trace through parts and over other traces. If you try to place a manual trace through a part or over another trace, an error is generated in the **DRC** tab of the **Spreadsheet View**.

Complete the following steps to place a trace manually:

1. Choose a copper layer.
2. Select or enter the desired trace size in the **Draw Settings** toolbar.
3. Choose **Place»Line**.
4. Click a pad on the board. The net the pad is a part of is highlighted, and the pads in the net are each marked with an X.
5. Make your way to the next pad in the net. Remember to avoid parts and other traces. Click to fix the trace to the board each time you change direction.

6. Click the next pad in the net. Continue in this way from pad to pad, clicking the points on the board where you must route the trace around obstacles.
7. When you place the final trace in the net, cancel trace placement by either pressing <Esc> twice or by right-clicking and selecting Esc from the pop-up menu that appears twice.

Narrowing/Widening Trace Width On-the-Fly

On occasion, it may be necessary to change the width of a trace segment (for example, when placing it in a narrow area between pins). You can change the width of a trace segment on-the-fly as detailed below.

Complete the following steps to change the trace width on-the-fly:

1. Begin placing the trace as detailed above.
2. Click to place a trace segment, right-click and select either **Widen** or **Narrow** from the pop-up that appears.
3. Continue placing the trace and left-clicking to anchor trace segments. The width of the trace segments either increases or decreases by 10% of the width of the previous trace segment, depending on whether you selected **Widen** or **Narrow**.



Tip If you want to increase or decrease the next segment by more than 10%, right-click and select either **Widen** or **Narrow** multiple times.



Note You will not be able to exceed the **Max Width** value for the net as set in the **Nets** tab of the **Spreadsheet View**, or set a width lower than the **Min Width** value.

Placing a Trace: Follow-me Method

While you must avoid obstacles such as other traces when placing a manual trace, a **Follow-me** trace avoids most of the obstacles that lie along a trace's route.



Note Refer to the [Placing a Trace: Manual Method](#) section for information about manual trace placement.

Complete the following steps to place a **Follow-me** trace:

1. Choose a copper layer.
2. Choose **Place»Follow-me**.
3. Click a pad on the board. The net the pad is connected to is highlighted, and the pads in the net are each marked with an X.



4. Move the mouse pointer to the next pad in the net. The trace follows the pointer, routing itself around most obstacles.
5. When you place the final trace in the net, cancel trace placement by either pressing <Esc> or by right-clicking.



Tip Use <Ctrl-Shift-W/N> to widen/narrow the trace. You can also change the trace width during routing by typing the desired value in the **Draw Settings** toolbar. Otherwise, trace size is determined from the net settings. If you attempt to change to a net width that is too big (DRC errors appear), the trace width will not change.

Placing a Trace: Connection Machine Method

The **Connection Machine** is the simplest and fastest way to connect two pads, but it cannot be used to connect more than two pads at a time.

Complete the following steps to place a **Connection Machine** trace with default routing:

1. Choose a copper layer.
2. Choose **Place»Connection Machine**.
3. Click a segment of a ratsnest on the board. The two pads connected by the segment of the ratsnest are connected with a trace that has been routed around obstacles.
4. Press <Esc> twice to end trace placement.



Complete the following steps to place a **Connection Machine** trace with custom routing:

1. Choose a copper layer.
2. Choose **Place»Connection Machine**.
3. Click a segment of a ratsnest on the board. The two pads connected by the segment of the ratsnest are connected with a trace that has been routed around obstacles.
4. Drag the trace segment to change the default routing around obstacles. The middle of the trace will move, although the trace remains anchored to the two specified pads.
5. Click to lock the moved trace segment in place.
6. Press <Esc> twice to end trace placement.





Tip Use <Ctrl-Shift-W/N> to widen/narrow the trace. You can also change the trace width during routing by typing the desired value in the **Draw Settings** toolbar. Otherwise, trace size is determined from the net settings. If you attempt to change to a net width that is too big (DRC errors appear), the trace width will not change.

Placing a Bus

Use to connect multiple traces between multi-pinned devices such as ICs.

The procedure below uses the following example.

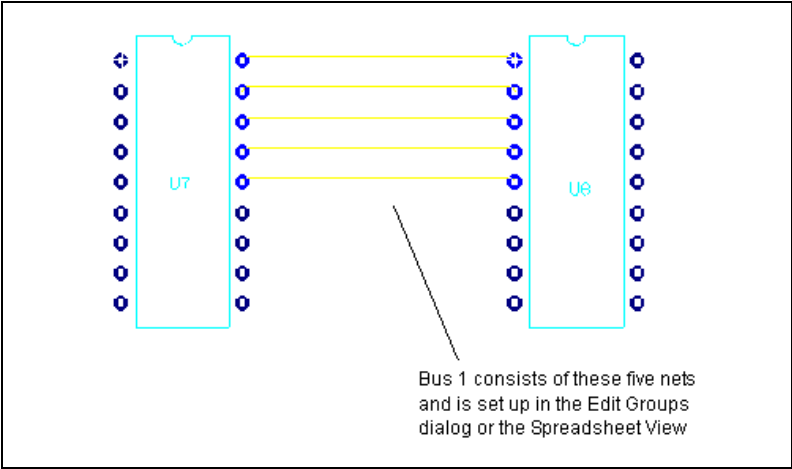

Complete the following steps to place the copper for the bus in the above example:

1. Be sure that you have not selected any pins.
2. Select **Place»Bus**. The cursor changes to a bus symbol. Click on a pin on each of the nets that you wish to place in the bus and then move the cursor towards the target IC.

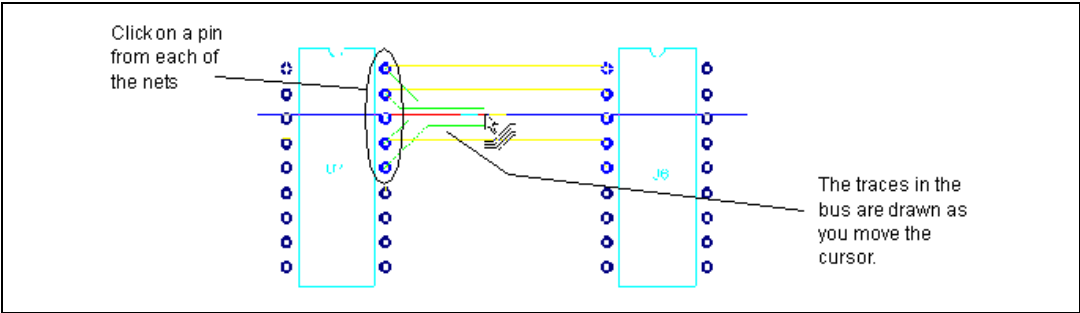

3. Move the cursor toward the bus's destination pins and double-click to complete copper placement.

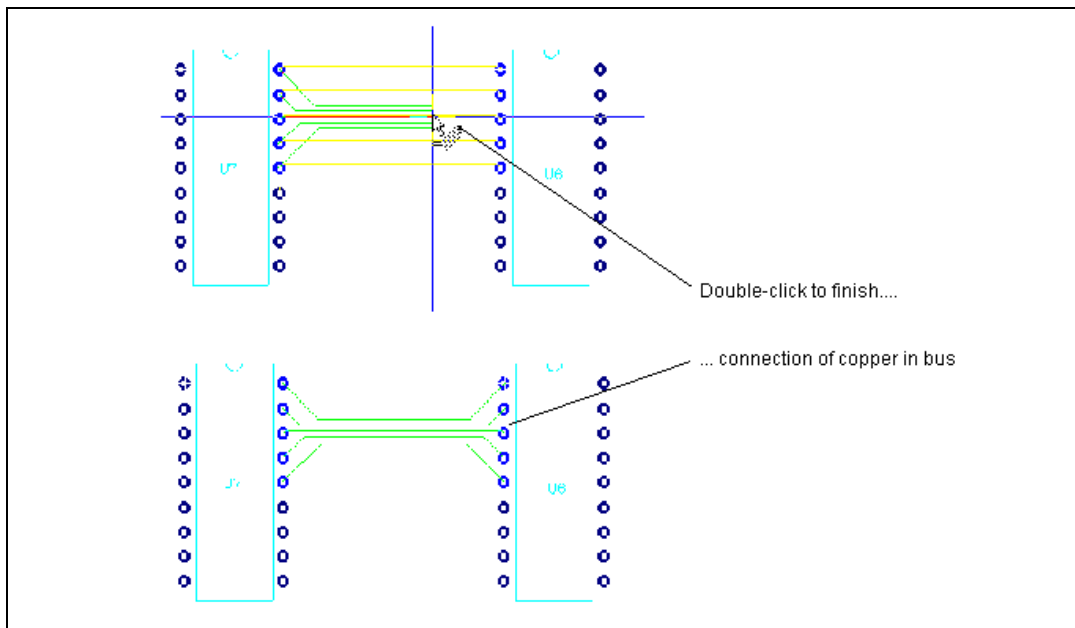

Working with Density Bars

Density bars use color to indicate the density of pins and pads at cross-sections of your board. The higher their density at any given cross-section, the more difficulty you will have routing traces through that section of the board and the more copper is used in that area. When placing parts you should strive to achieve relatively equal density distributions to avoid difficult-to-route areas.

As the design's pin/pad density gets heavier, the color of the density bars changes from green to red.

When you start Ultiboard, the density bars are toggled off by default. If you toggle the density bars on, they appear on the right side and underneath the design.



To toggle the density bars on, or off again, choose **View»Density Bars**.

Working with Keep-in/Keep-out Areas

A Keep-in area is a polygon that you set so that when objects are moved outside of it, a DRC error is generated. Conversely, a Keep-out area generates a DRC error when objects are moved into it.

Placing Keep-in/Keep-out Areas

The **Keep-in/Keep-out properties** dialog box lets you place a polygon that will act as either a Keep-in or a Keep-out area. By default, a Keep-out is placed.

Complete the following steps to add a restricted area:

1. Choose **Place»Keep-in/Keep-out Area**.
2. Left-click all points that are to define the polygon, ending with the starting point.

Viewing and Editing Keep-in/Keep-out Properties

To display the **Keep-in/Keep-out properties** dialog box, select the desired keep-in/out and select **Edit»Properties**. (The **Keep-in/out** layer must be active).

The **Keep-in/Keep-out properties** dialog box consist of two tabs: **Attributes** and **Keep-in/keep-out**.

The **Attributes** tab allows you to edit the properties of the selected area. For more information on editing properties in the **Attributes** tab, refer to the *Attributes* section of Chapter 4, *Working with Parts*.

The **Keep-in/Keep-out** tab lets you set specific parameters.

Complete the following steps to set Keep-in/Keep-out parameters:

1. In the **Type** box, select either **Keep-out** or **Keep-in**.
2. In the **Layers** box, check the layers to which the Keep-in/out applies.
3. Optionally, enter the a **Name** for the Keep-in/out area.

4. Optionally, click on one of the following checkboxes in the **Advanced options** area and then click the **Options** button when it becomes active:
 - **Net Group**—Displays the **Select Groups** dialog box where you select the net groups to which you wish to apply the Keep-in/out.
 - **Part Height**—Displays the **Part Height Ranges** dialog box where you enter the height of parts to which you wish the Keep-in/out area to apply.
 - **Part Group**—Displays the **Select Groups** dialog box where you select the part groups to which you wish to apply the Keep-in/out area.
5. Click **OK** in the **Keep-in/Keep-out Properties** dialog box.

If no **Advanced options** are set:

- A DRC error is reported if an object is moved outside of a Keep-in area.
- A DRC error is reported if an object is inside a Keep-out area.
- If there are multiple Keep-ins or Keep-outs, the objects may be divided amongst the different areas at your discretion. Multiple areas then behave as a single disjointed area.

If any **Advanced options** are set:

- A DRC error is reported if an object is moved outside of a Keep-in area.
- A DRC error is reported if an object is inside a Keep-out area.

Equi-Spacing Traces

This option lets you set the spacing between traces to be equal.

Complete the following steps to equi-space traces:

1. Select two traces that surround at least one other trace, as shown in the figure below.



2. Select **Tools»Equi-space Traces**. The spacing between the traces is made equal, as shown in the example in the figure below.



Note The selected traces must be between two objects (that is, two pins, two traces); initial spacing between traces must not be equal; traces must belong to a net in the same layer. Rubber-banding does not work with this feature, hence some traces may become disconnected.

Deleting a Trace

Traces can be deleted like other objects. When you delete a trace, you are not asked to confirm the deletion, but you can undo the deletion by choosing **Edit»Undo** immediately after making the deletion.



Note Depending on your setting in the **PCB Design** tab of the **Preferences** dialog box, vias associated with a trace will be deleted when that trace is deleted.



To delete a trace that you have just placed, choose **Edit»Undo Place Trace Segment**.

Complete the following steps to delete an existing trace:

1. Select the trace.
2. Choose **Edit»Delete**.

Or

1. Select the trace.
2. Press the DELETE key.



Working with Other Copper Elements

This section contains the following subjects:

- [Placing Copper Areas](#)
- [Placing Powerplanes](#)
- [Splitting Copper](#)
- [Converting a Copper Shape to an Area](#)
- [Deleting All Copper](#)
- [Adding and Removing Teardrops](#)

Placing Copper Areas

Use the **Place»Copper Area** command to define copper polygons.

Complete the following steps to place a copper area:

1. Choose a copper layer.
2. Choose **Place»Copper Area**. The pointer has a polygon shape attached.
3. Left-click all points that are to define the copper area, ending with the starting point.
4. Optionally, right-click to cancel the **Place** command.



Complete the following steps to delete a copper area:

1. Choose **Edit»Copper Delete»Copper Island**.
2. Click on the copper area you want to delete.

Placing Powerplanes

Powerplanes are copper areas that cover the entire plane.

Complete the following steps to place a powerplane:

1. In the **Layers** tab, select the layer to be used as a powerplane.
2. Choose **Place»Powerplane**. The **Choose Net and Layer for Powerplane** dialog box appears.
3. Specify the **Net** and **Layer** for the powerplane.
4. Click **OK**. The **Choose Net and Layer for Powerplane** dialog box disappears and the powerplane is placed on the layer that you specified.



Splitting Copper

The **Polygon Splitter** is used to split copper areas or powerplanes.

Complete the following steps to split a copper area or powerplane:

1. Choose **Design»Polygon Splitter**.
2. Move the pointer to the polygon you want to split.
3. Click at the point where you want to begin the split.
4. Move the pointer over the polygon. A line appears to indicate where the split will occur. Move the line to the desired place and click to finish the split.
5. Right-click to cancel the **Polygon Splitter** function.



Converting a Copper Shape to an Area

Use to convert a copper shape to a polygon that supports voiding around unconnected nets.

Complete the following steps to shape a copper shape to an area:

1. Select a copper shape in your workspace. The figure below shows a copper shape (green) that straddles two pins and traces.

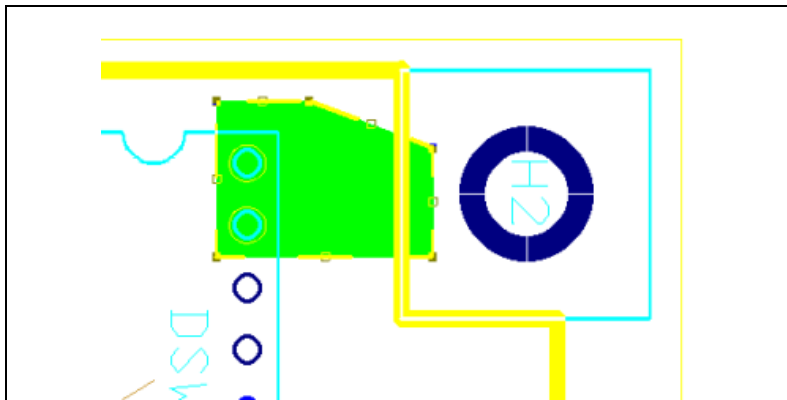

2. Select **Design»Shape to Area**. The copper is cut out to avoid the other elements within its area, as in the example shown below.

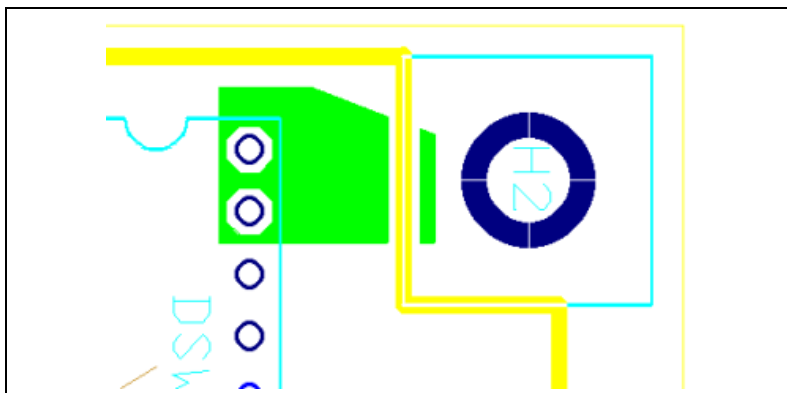

Deleting All Copper



To delete all copper elements (traces, copper areas, and powerplanes) and start over, choose **Edit»Copper Delete»All Copper**. This deletes all copper elements in the design.

Adding and Removing Teardrops

A teardrop is a flair that you can add to a trace where the trace connects to a pad. This is typically used with very small sized traces, to prevent possible breakage in the copper between the trace and the pad.

Complete the following steps to add teardrops:

1. Select **Design»Add Teardrops**. The **Teardrops** dialog box displays.
2. Select the **Units** for the teardrop length.
3. In the **Length** box, enter the **Preferred** and **Minimum** length for the teardrops. The preview area changes as the lengths are changed.
4. In the **Apply to** box, select the following as desired:
 - **Selected pads** radio button—Teardrops will be added to the pads that are currently selected on the workspace.
 - **All of the following** radio button—When selected, enables the **SMT pins**, **THT pins** and **Standard vias** checkboxes; check as desired.
5. In the **On DRC error** box, select the desired radio button. Choices are **Do not create teardrop**; **Ask for confirmation**; **Create teardrop**.
6. Enable or disable the **Ignore pad without net** checkbox as desired.
7. Click **OK** to add the teardrops are added.

To remove all teardrops select **Edit»Copper Delete»All Teardrops**.

Viewing and Editing Copper Properties

All copper elements (traces, copper areas, and powerplanes) share the same three properties tabs (**Attributes**, **General**, and **Position**). The fourth tab for traces is **Line**, and the fourth tab for copper areas and powerplanes is **Copper Area**.

The **General** tab is where you edit the properties of the selected copper element.

Complete the following steps to edit the contents of the **General** tab:

1. In the **Measurements** box, set the desired **Width**. **Net** shows the net to which the element is connected, if any. It is read-only.
2. In the **Autorouter Settings** box, select either **Trace is Fixed** or **Trace can be Moved**. User-placed traces are fixed (default setting) so that they will not be moved when autorouting is performed.

3. Optionally, change the **Units** (of measurement).
4. In the **Clearances** box, enter the desired clearance of the selected object to traces in the **To Trace** field.

The **Attributes** tab is where you edit the attributes of the selected copper element.

Refer to the *Attributes* section of Chapter 4, *Working with Parts*, for more information.

The **Position** tab is where you change the layer the selected copper element is on, from the **Layer** drop-down list. You can also use this tab to lock the copper element on the layer.

The **Line** tab is the default when the selected copper element is a trace.

Complete the following steps to control the coordinates for the trace's start and end points:

1. Enter the following in the **Points** box:
 - **X1**—The X coordinate of the trace's starting point
 - **X2**—The X coordinate of the trace's ending point
 - **Y1**—The Y coordinate of the trace's starting point
 - **Y2**—The Y coordinate of the trace's ending point

When a copper area is selected, the **Copper Area Properties** dialog box includes a **Copper Area** tab.

Complete the following steps to set a copper area's net and parameters:

1. In the **Thermal Reliefs** box, select the thermal reliefs and styles desired using the following:
 - **SMD Pads** checkbox—Enable to have thermal relief applied to SMD pads.
 - **Padstacks** checkbox—Enable to have thermal relief applied to padstacks.
 - **Vias** checkbox—Enable to have thermal relief applied to vias.
 - **Style to Use when Referenced by Pad** drop-down list—The thermal relief shape to use when referenced by a part's pad.
 - **Spoke Width to Use when Referenced by Pad** drop-down list—The size of the spokes a thermal relief will have when it is referenced by a part's pad.

2. In the **Remove Islands** box, set the parameters to remove islands using the following (an island is a section of copper within the copper area that is not connected to any other copper):
 - **Smaller than** checkbox—Enable the checkbox and enter the desired setting. Any copper islands with length and width smaller than this value are automatically deleted.
 - **Not connected to outer edge** checkbox—Any unconnected copper *within* the copper area will be removed.
 - **Reset all manual removed islands** checkbox—Select to replace all islands that you removed manually (that is, by selecting and deleting).
3. Select **Enable voiding** if you wish the area around traces and pins not to be connected to the copper area.
4. If you wish to connect the copper area to a net, enable **Connected to Net** and select the desired net from the list.

Working with Vias

This section contains the following topics:

- *Placing Vias*
- *Viewing and Editing Via Properties*

Placing Vias

A via is a plated through-hole in a printed circuit board used to connect two or more layers, as well as the top and bottom surfaces of the board.

Once placed, a via can be moved like a part. Refer to the *Tools to Assist Part Placement* of Chapter 4, *Working with Parts*, section for more information.

Complete the following steps to place a via:



1. Choose **Place»Via** and click on the board where you want to place the via. The **Select the lamination that is to be used for this via** dialog box appears.
2. Select the layers that the via is to run between (**From Layer** and **To Layer**).
3. Click **OK**. The dialog box disappears.
4. Right-click to cancel the **Place Via** command, or click in another location to place another via.



Note Depending on your setting in the **PCB Design** tab of the **Preferences** dialog box, vias associated with a trace may be deleted when the trace is deleted.

Viewing and Editing Via Properties

Via properties consist of five tabs: **Attributes**, **General**, **Via**, **Layer Settings** and **Thermal Relief**.

The **Attributes** tab allows you to edit the properties of the selected via. Refer to the *Attributes* section of Chapter 4, *Working with Parts*, for more information.

The **General** tab is the default, and appears when you choose **Edit>Properties**. It allows you to change the X/Y coordinates, the size of the clearance, the via angle, the side of the board the via is on, and to define the units of measurement.

Complete the following steps to change the settings in the **General** tab:

1. In the **Measurements** box, set the following as desired:
 - **X,Y**—The X and Y coordinates of the via.
 - **Net**—The net the via is connected to (read-only).
 - **Angle(degrees)**—Leave at 0.00.
 - **Board side**—Select either **Top** or **Bottom** radio button (read-only).
2. Optionally, enable the **Locked** checkbox to lock the via in place, and change the **Units** of measurement.
3. In the **Clearances** box, enter the desired clearance of the selected via to traces in the **To Trace** field.

Complete the following steps to change the settings in the **Via** tab:

1. Enable the **Assume net** checkbox to assign a specific net to the via, then select the net from the drop-down list.
2. In the **Via Settings** box, set the following as desired:
 - **Use Design Rules** radio button—Select to use the settings in the **Pads/Vias** tab of the **PCB Properties** dialog box.
 - **Pad Diameter** radio button—Select to enter the diameter of the selected via's pad in the drop-down list. The **Drill Diameter** drop-down list is also activated; enter the desired value.
 - **Plated** checkbox—Check to plate the inside of the via's drill hole.

3. In the **Autorouter Settings** box, select either **Via is Fixed** or **Via can be Moved** (during autorouting).
4. In the **Solder Mask** box, select the following as desired:
 - **Top** checkbox—Enable to place a solder mask on the top of the PCB.
 - **Bottom** checkbox—Enable to place a solder mask on the bottom of the PCB.

If the via that you have selected is a micro via, the **Micro Via** tab displays instead of the **Via** tab.

Complete the following steps to change the settings in the **Micro Via** tab:

1. Enable the **Assume net** checkbox to assign a specific net to the micro via, then select the net from the drop-down list.
2. In the **Autorouter Settings** box, select either **Via is Fixed** or **Via can be Moved** (during autorouting).
3. In the **Solder Mask** box, select the following as desired:
 - **Top** checkbox—Enable to place a solder mask on the top of the PCB.
 - **Bottom** checkbox—Enable to place a solder mask on the bottom of the PCB.
4. In the **Via Settings** box, set the following as desired:
 - **Use Design Rules** radio button—Select to use the settings in the **Pads/Vias** tab of the **PCB Properties** dialog box.
 - **Pad Diameter** radio button—Select to enter the diameter of the selected via's pad in the drop-down list. The **Landing Pad** and **Drill Diameter** drop-down lists are also activated; enter the desired values in these.
5. In the **Layer Settings** list, enable which layers to **Allow Autorouting**.

Complete the following steps to change the settings in the **Thermal Relief** tab:

1. Set the width of the thermal relief's spokes in the **Spoke Width** area.
2. Enable the desired radio button in the **Type** area to set the shape of the thermal relief. If you do not wish to use thermal relief for the via, select **No thermal relief**.

Placing SMD Fanouts

The **Fanout SMD** command attaches vias to each pin of either a selected surface mount device (SMD) or all SMDs on the board.

Complete the following steps to place SMD fanouts:

1. Optionally, select the part(s) to which you wish to apply fanouts, as in the example shown in the figure below.

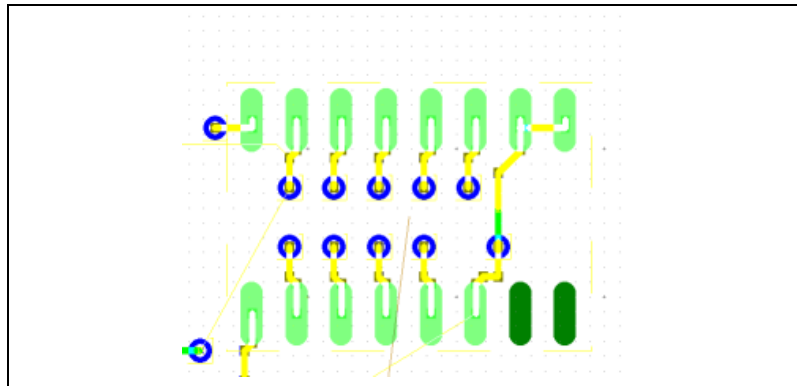

2. Select **Design»Fanout SMD**. The **Fanout Options** dialog box appears.
3. In the **Fanout Type** box, select one of:
 - **Fanout Board**—Fanout action will apply to the entire board.
 - **Fanout Selected Part**—Fanout action will apply to the selected part only.
4. In the **Fanout Via Configuration** box, enter the following as desired:
 - **Via Drill Diameter**—The diameter of the placed vias' holes.
 - **Via Pad Diameter**—The diameter of the placed vias' pads.
 - **Via Spacing Factor**—This is for PGA parts only (it does nothing for non-PGA parts); determines how far apart the vias are placed. For example, if the distance between the SMT pins is 2mils, and the **Via Spacing Factor** is 2, then the distance between the vias will be $2\text{mils} \times 2 = 4\text{mils}$. The direction of this distance depends on where the via is placed, but basically, if the SMT pin is at the top, the the via will also be at the top, and the distance is the Y distance between each row of vias will be 4mils. The distance also depends on the particular part - each part may have different SMT spacing, so the distance may vary.

- Click **Start Fanout**. The **Fanout Options** dialog box disappears and the fanout vias are placed on the design, as circled in the figure below.

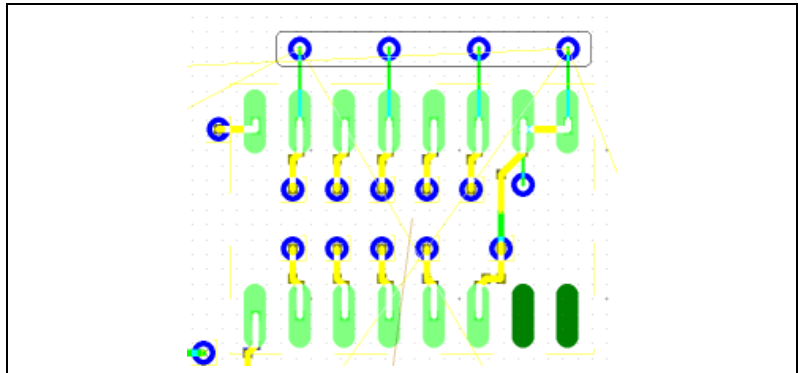

Working with Nets

This section contains the following subjects:

- *Using the Nets Tab*
- *Using the Netlist Editor*
- *Highlighting a Net*
- *Shielding Nets*
- *Net Bridges*
- *Copying a Copper Route*

Using the Nets Tab

The **Nets** tab buttons in the **Spreadsheet View** allow you to preview a net in relation to the board, find a net, highlight a selected net, lock and unlock a selected net, set the width and clearance of a selected net, and remove the copper of a selected net.

Complete the following steps to preview a net:



- Click the **Show preview** button to toggle the **Preview** function on if it is not already.
- Click the net in the list. A picture of the path the net makes on the board displays in the preview area.

Complete the following steps to find a net in the design:

1. Click the net in the list to select it.
2. Click the **Find the selected net** button. The view zooms in on the net and selects it.



Complete the following steps to highlight a selected net:

1. Click the net in the list to select it.
2. Click the **Highlight selected nets** button. The selected net is highlighted on the design. (You can change the highlight color from the **Color Element** drop-down list in the **Colors** tab of the **Preferences** dialog box).



Complete the following steps to lock and unlock any copper placed for a net:

1. Click the net in the list to select it.
2. Click the **Lock the selected net** button to lock an unlocked net, or to unlock a locked net.



Complete the following steps to remove the copper of a selected net:

1. Click the net in the list.
2. Click **Remove Copper**. You are prompted to confirm the removal.
3. Click **Yes** to remove the copper. The copper is deleted and the ratsnest reappears.



Note Refer to the [Spreadsheet View](#) section of Chapter 1, *User Interface*, for information about the other buttons in this tab.

Using the Netlist Editor

You can use the netlist editor to view the nets in the design and to view the pins in the nets. You can also use it to add and delete nets from the design, add/delete pins from an existing net, adjust trace widths in a net, set high speed parameters and adjust a net's via diameters and via drill hole size.

To open the netlist editor, choose **Tools»Netlist Editor**. The **Net Edit** dialog box opens.

Complete the following steps to lock a net in place:

1. Select the desired net in the **Net** drop-down list.
2. Click the **Lock Net** button.



Complete the following steps to add new pins to a locked net:

1. Select the desired net in the **Net** drop-down list.
2. Click the **Lock Net** button to unlock the net.
3. Add the necessary pins and connections. Refer to the *Adding a Net* section for more information.
4. Route the new net.
5. Click the **Lock Net** button.



To show or hide a ratsnest, click the **Show/Hide Ratsnest** button. When depressed, this button shows the ratsnest for the net selected in the **Net** drop-down list. Refer to the *Working with Ratsnests* section of Chapter 4, *Working with Parts*, for information about ratsnests.

Adding a Net

Complete the following steps to add a net:

1. Select **Tools»Netlist Editor** and click the **Pins** tab.
2. Click **New**. The **Add Net** dialog box displays.
3. Enter a name and click **OK**. The new net name displays in the **Net** list.

The light green “lamp” indicates that there are no pins connected to the net. The field in the middle of the pins tab is blank because the new net has no pins connected. See below to add pins to a net.

Complete the following steps to add a pin to a new or previously existing net:

1. Select **Tools»Netlist Editor** and click the **Pins** tab.
2. Select the desired net from the **Net** drop-down list in the **Net edit** dialog box.



Tip You can also select the net by clicking on the button to the right of the drop-down list and then clicking on one of the pins from that net in the workspace. To do this, there must already be pins connected to the net.

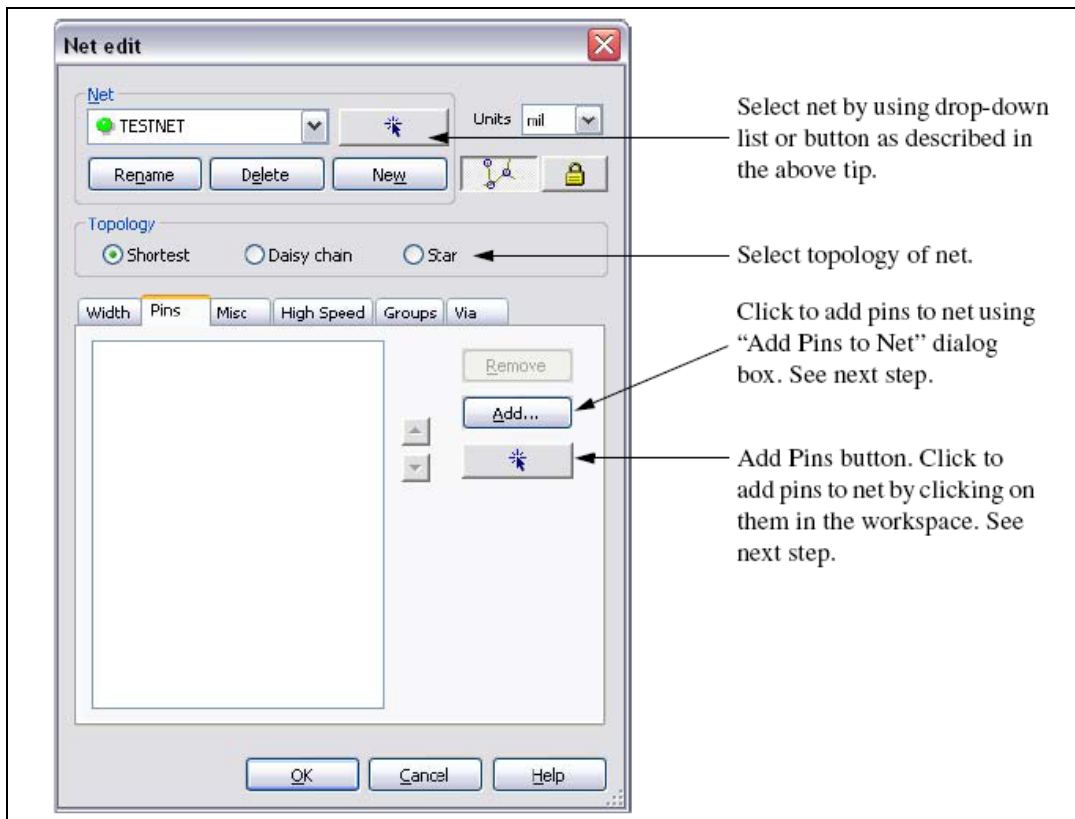

The remainder of this section uses the example shown in the figure below. The parts shown are not connected any net.

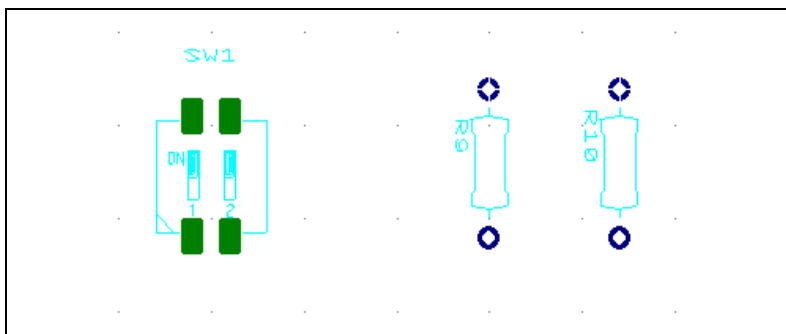

3. Click the **Add pins** button and click the desired pin in the workspace. Continue until all pins for the net are listed in the **Pins** area.

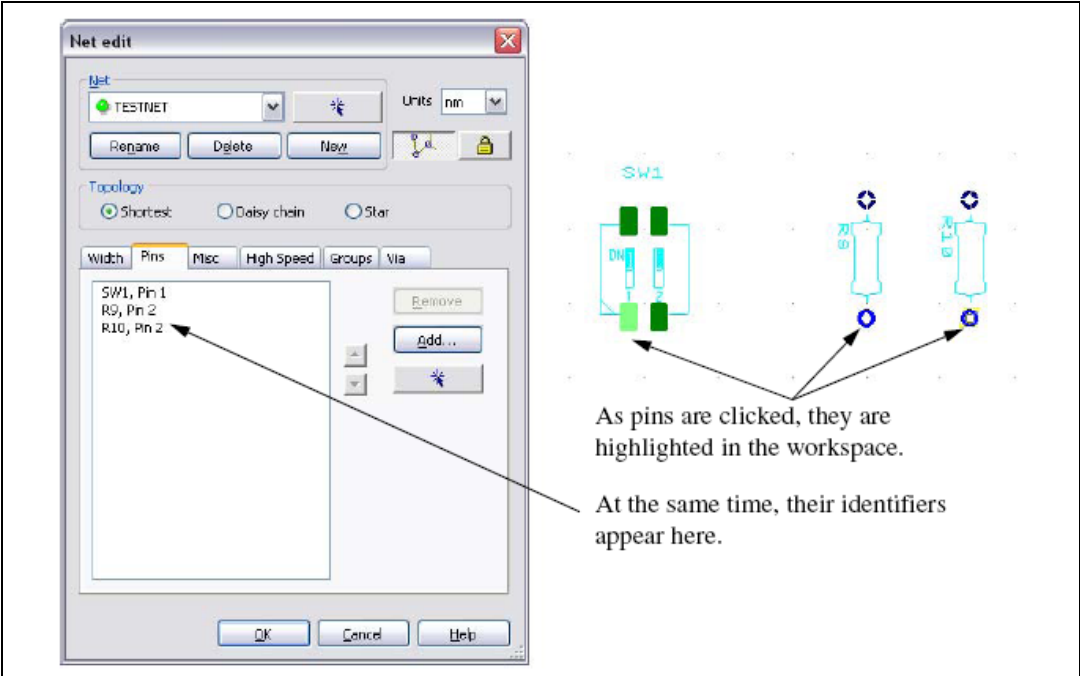

Or

Click **Add**. The **Add Pins to the Net** dialog box displays.

Highlight the pins to be added and click **Add**. The dialog box closes and the **Net edit** dialog box shows the added pins in the list of pads for the displayed net.

- 4. Click **OK** in the **Net edit** dialog box. The dialog box closes and the net information is added in the workspace, including its ratsnest and force vectors. Refer to the *Working with Ratsnests* and *Working with Force Vectors* sections of Chapter 4, *Working with Parts*, for more information.

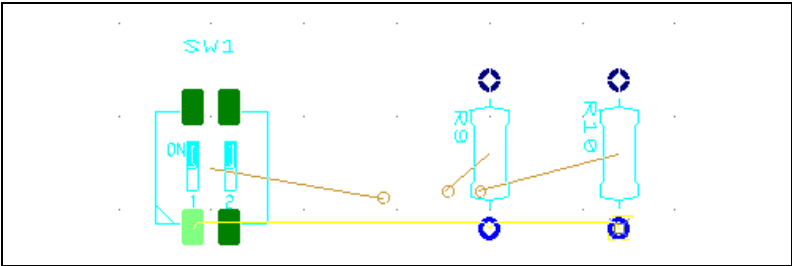

Complete the following steps to change a net's topology.

1. Select **Tools»Netlist Editor** and select the net from the **Net** drop-down list in the **Net edit** dialog box.
2. Click either **Shortest**, **Daisy chain** or **Star** in the **Topology** area and click **OK**. The ratsnest placement on the workspace changes to reflect the new topology.
 - **Shortest**—When connections are made, the shortest distance possible will be maintained. The order for the connection is not considered. Refer to the figure below for an example.

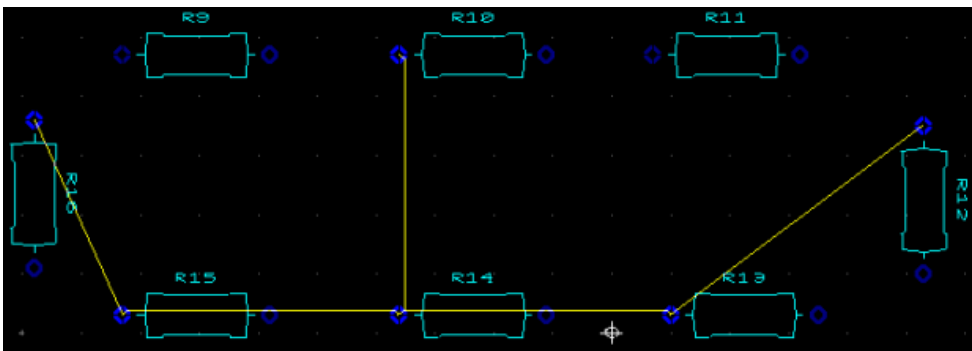

- **Daisy chain**—The connection between pins is based on the order in which the pins are selected. The connection distance between pins is not considered. Refer to the figure below for an example.

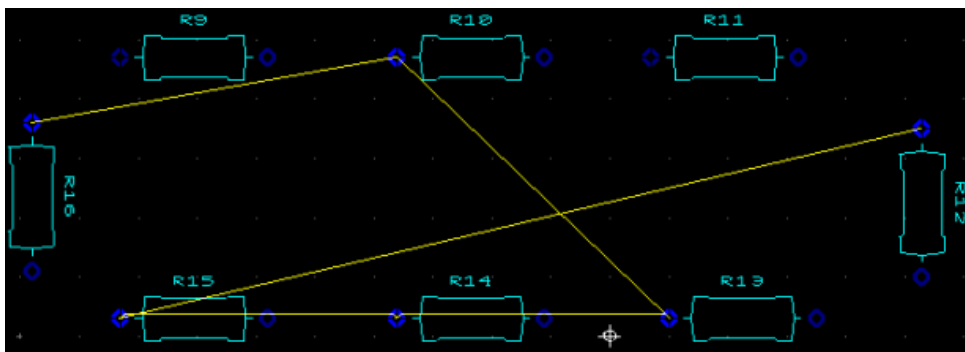

- **Star**—Pins are connected with a reference point, which is the first selected pin. Other pins will only be connected to the reference source. The effect is like a star, with connections radiating out to other pins. Orders in which the pins are selected or the distance between pins are not considered. If the first pin is deleted from the

net, then the pin below the reference point will become the source. Refer to the figure below for an example.

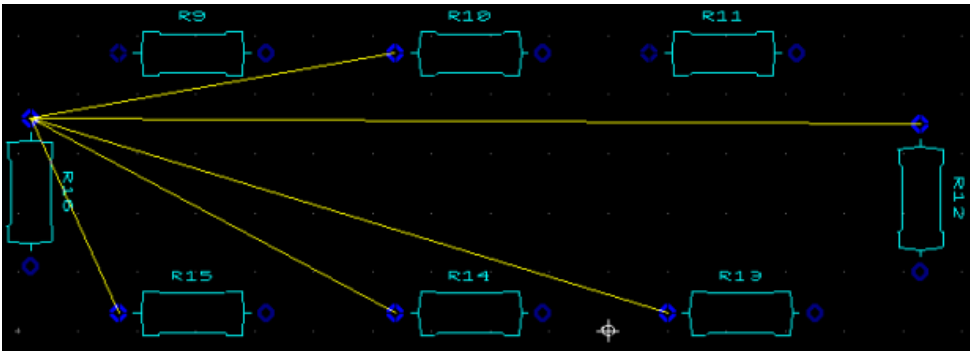

Renaming a Net

Complete the following steps to rename a net:

1. Select **Tools»Netlist Editor** and select the desired net from the **Net** drop-down list in the **Net edit** dialog box.
2. Click **Rename** in the **Net edit** dialog box. You are prompted for the new net name.
3. Type a name for the net.
4. Click **OK** to save the new name.

The new net name appears in the **Net** drop-down list in the **Net edit** dialog box, and in the **Nets** tab in the **Spreadsheet View**.

Deleting a Net

Complete the following steps to delete a net:

1. Select **Tools»Netlist Editor** and click **Delete** in the **Net edit** dialog box. The **Select the net to delete** dialog box appears.
2. Select the net to be deleted.
3. Click **Delete** to delete the net. The **Select the net to delete** dialog box closes, and the net no longer appears in the **Net** drop-down list of the **Net edit** dialog box, or the **Nets** tab in the **Spreadsheet View**. The net is also removed from the board, but while the net disappears, the traces stay on the board.



Note There is no deletion confirmation. To cancel the deletion before you click **Delete**, click **Close**.

Deleting a Pin from a Net

Complete the following steps to delete a pin from a net:

1. Select **Tools»Netlist Editor**, click the **Pins** tab and select the desired net from the **Net** drop-down list in the **Net edit** dialog box.
2. Highlight the pin you wish to delete in the list in the **Pins** tab and click **Remove**.

The pin disappears from the list of pins for the net displayed.



Note There is no deletion confirmation.

3. Click **OK** to close the **Net edit** dialog box.

Setting Net Widths

Complete the following steps to set net widths:

1. Select **Tools»Netlist Editor** and select the desired net from the **Net** drop-down list in the **Net edit** dialog box.
2. Click on the **Width** tab.
3. Enter the **Minimum trace width**, **Default trace width**, **Maximum trace width**, and **Trace clearance**, or choose **Use Group Settings** from the drop-down lists.
4. Click **OK** to save changes.

Setting High Speed Parameters

Complete the following steps to set high speed parameters for a net:

1. Select **Tools»Netlist Editor** and select the desired net from the **Net** drop-down list in the **Net edit** dialog box.
2. Click the **High Speed** tab.

Enter the following as required:

- **Parallelism check**—Enable checkbox and enter **Maximum length** that traces can run in parallel. Enter size of **Gap** (allowable distance) between parallel traces on **Same layer** and **Adjacent layer**. In the **Against net** field, select the net against which the parallelism check is done.
 - **Route length check**—Enable checkbox and enter **Minimum** and **Maximum** lengths for the length of copper between connected pins for **Daisy chain** and **Star** topologies (this checkbox is only active for these topologies).
3. Click **OK** to close dialog box and accept changes.

Setting Miscellaneous Net Parameters

Complete the following steps to set miscellaneous parameters for a net:

1. Select **Tools»Netlist Editor** and select the desired net from the **Net** drop-down list in the **Net edit** dialog box.
2. Click on the **Misc** tab.
3. In the **Routing Layers** area:
 - Select layers to use for routing copper for the selected net.



Note If the selected net is part of a net group, the **Use Group Settings** checkbox will be checked. Turn this off if you wish to make changes in the **Routing Layers** area.

4. In the **Priority** field:
 - Enter the routing priority for the selected net. “1” is the highest priority, “2” the second highest, etc. Leave as None if priority routing is not required.
5. In the **Net Shielding** area:
 - Select which **Net** is used for the shield. **Width** becomes active - change as desired.



Note Shields are copper that is placed around a selected net to act as a buffer or to shield the net from signal interference.

6. Enter desired parameters and click **OK**.

Setting Group Parameters

Complete the following steps to enter group information for a net:

1. Select **Tools»Netlist Editor** and select the desired net from the **Net** drop-down list in the **Net edit** dialog box.
2. Click on the **Groups** tab.
3. Select the desired **Net group** from the drop-down list.
4. Optionally, to enter a group for a bus and/or differential pair for the selected net, click the **Bus** or **Differential pair** radio button and select the group from the drop-down list. These groups are created in the **Edit Groups** dialog box. Refer to the [Working with the Group Editor](#) section of Chapter 3, [Setting Up a Design](#), for more information.
5. Enter desired group parameters and click **OK**.

Setting Via Parameters

Complete the following steps to edit via information for a net:

1. Select **Tools»Netlist Editor** and select the desired net from the **Net** drop-down list in the **Net edit** dialog box.
2. Click on the **Via** tab.
3. Set desired **Via Drill Diameter** and **Via Pad Diameter** and click **OK**.

Highlighting a Net

Complete the following steps to highlight a net:

1. Click on a segment of the net that you wish to highlight.
2. Select **Design»Highlight Selected Net**. The entire net is highlighted on the workspace and also in the **Preview** area of the **Nets** tab of the **Spreadsheet View**.



Tip You can change the highlight color from the **Color Element** drop-down list in the **Colors** tab of the **Preferences** dialog box.

Shielding Nets

Complete the following steps to shield a net:

1. Select **Design»Shield Nets**. The **Net Shielding** dialog box appears.
2. Select one of the following in the **Width** box:
 - **Use Net Settings** radio button—Select to use net settings. Refer to the *Spreadsheet View: Nets Tab* section of Chapter 1, *User Interface*, and the *Using the Netlist Editor* section for more information.
 - (unlabelled) radio button—Select and enter a width for the shielding that differs from the net settings.
3. Enter the desired size for the gap between net and shield in the **Gap** box.



Note The **Preview** changes as parameters are adjusted.

4. Click **Advanced** to display the **Advanced Net Shielding Options** dialog box.

5. Select the net to use for the shield in the **Shield net** area:
 - **Use Net Settings**—Select to use the shield set in the **Spreadsheet View** (also set in the **Net edit** dialog box).
 - **GND**—Select to activate the drop-down list, where you can pick the net to use for the shield.
6. In the **On DRC Error** area, select the action to take when a DRC error occurs.
7. In the **On Other Failures** area, select the action to take when other errors occur.
8. In the **Nets** area, select the nets you wish to shield.
9. In the **Layers** area, select the layers on which you wish to place the shielding.
10. Click **OK**. You are returned to the **Net Shielding** dialog box.
11. Click **OK**.

The shielding appears as illustrated below:

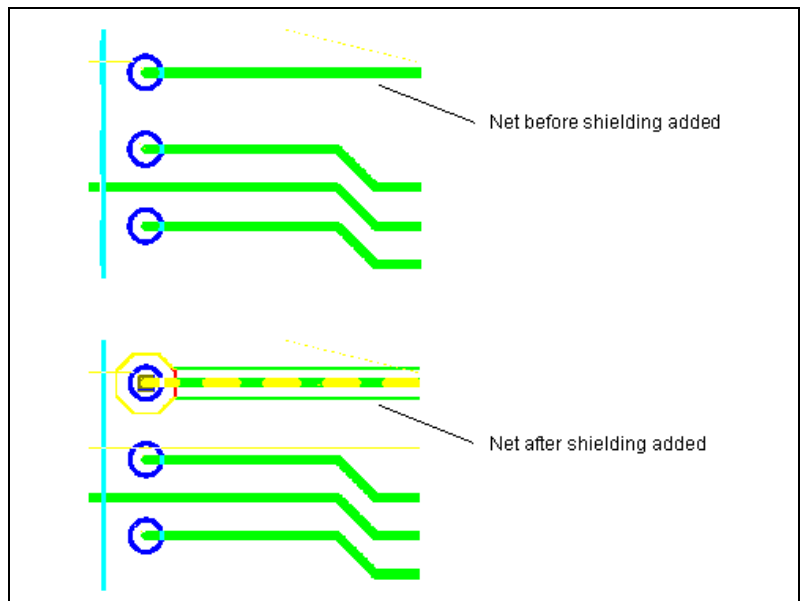

12. Results appear in the **Results** tab of the **Spreadsheet View**. You may click on an error to go to the problem area.

Net Bridges

The net bridge functionality permits connections between different nets (for example, digital and analog grounds) without losing the properties of either net.

Creating a Net Bridge

Complete the following steps to create a net bridge:

1. Select **Tools»Database»Database Manager**.
2. Click the **Create New Part** button in the **Parts** area, select **Net bridge** and click **OK**. The **Net Bridge Edit Layer** displays on your workspace.
3. Select **Place»Net Bridge Pins** to display the **Place Net Bridge Pin** dialog box.
4. Enter the desired parameters for the first pin of the net bridge, click **OK** and place the pin on the workspace.
5. Select **Place»Pins** again, enter the parameters for the second pin of the net bridge, click **OK** and place the pin on the workspace in the desired location.

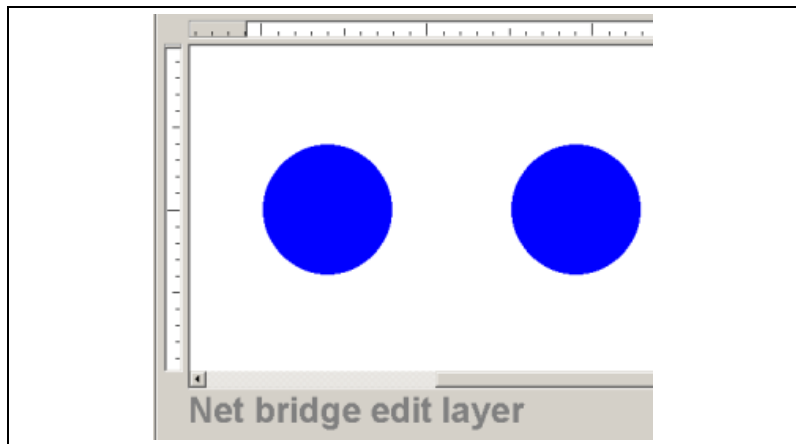

6. Connect the two pins by selecting **Place»Shape»Rectangle** and drawing a rectangle between them, being sure to overlap the two pins.

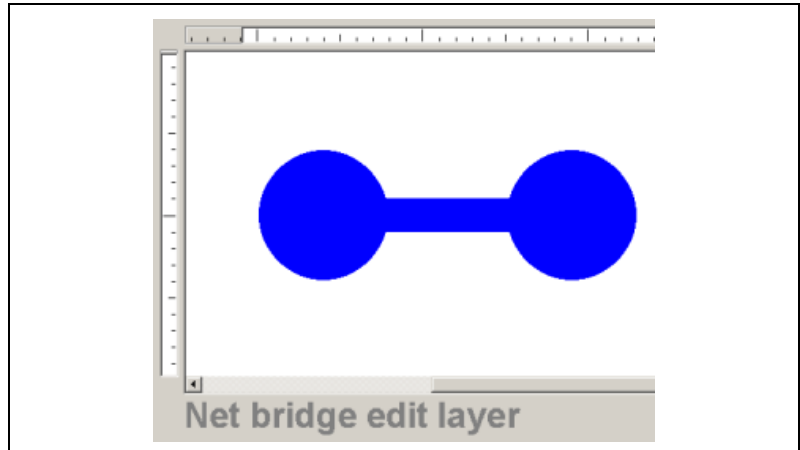

7. Close the **Net Bridge Edit Layer**, and when prompted, Click **Save**.
8. The following dialog box appears. Enter the name for the new netbridge (Netbridge2 in the following example):

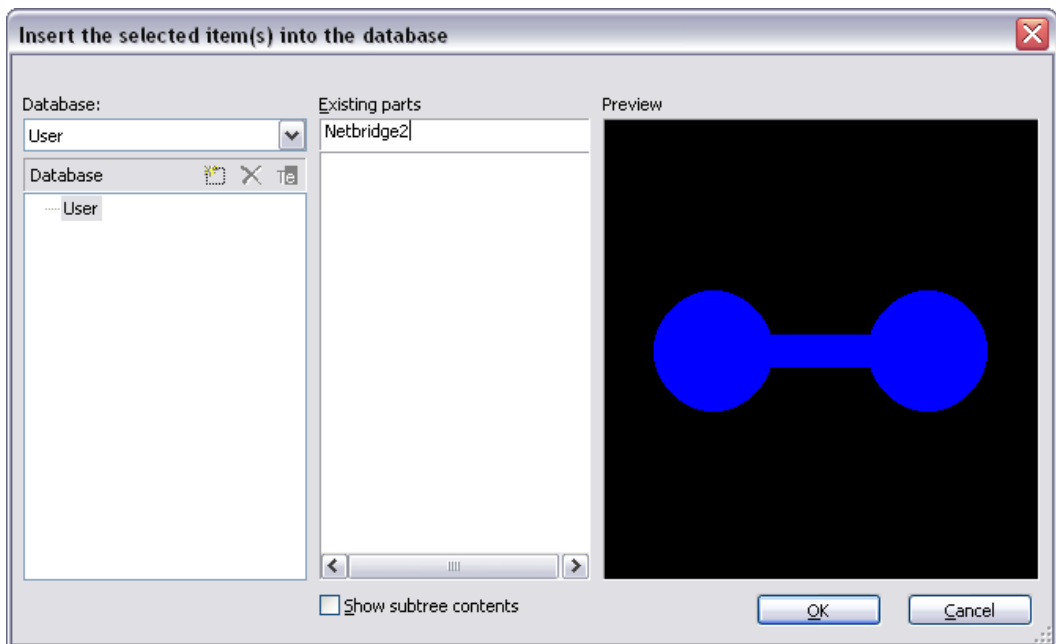

9. Click **OK**.

Placing a Net Bridge

This example connects two traces - one is on net “DGND” and the other is on net “GND”.

Complete the following steps to place a net bridge:

1. Select **Place»Net Bridge**. The **Place Net Bridge** dialog box appears.
2. Click **Select Net Bridge From Database**. The **Get a part from the database** dialog box appears.
3. Select the desired net bridge in the **Available Parts** area and click **OK**. You are returned to the **Place Net Bridge** dialog box.
4. Map the pins of the net bridge to the desired nets in the **Pin 1** and **Pin 2** area. In the example below, digital ground (DGND) and analog ground (GND) are mapped together.

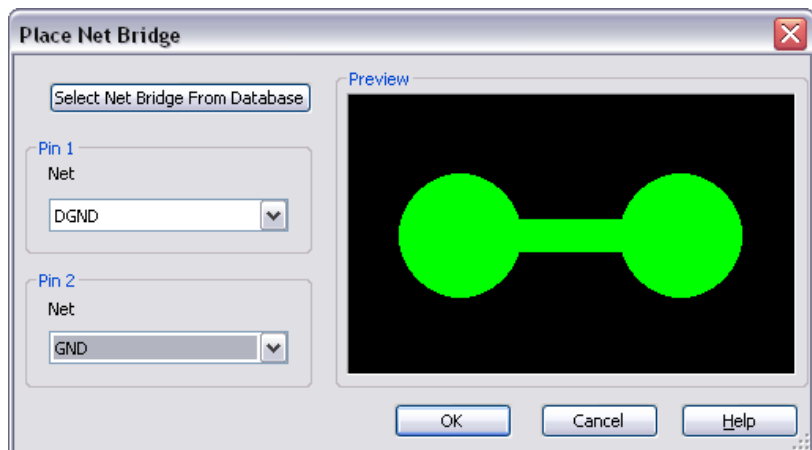

5. Click **OK** and place the netbridge across the two nets as in the example below.

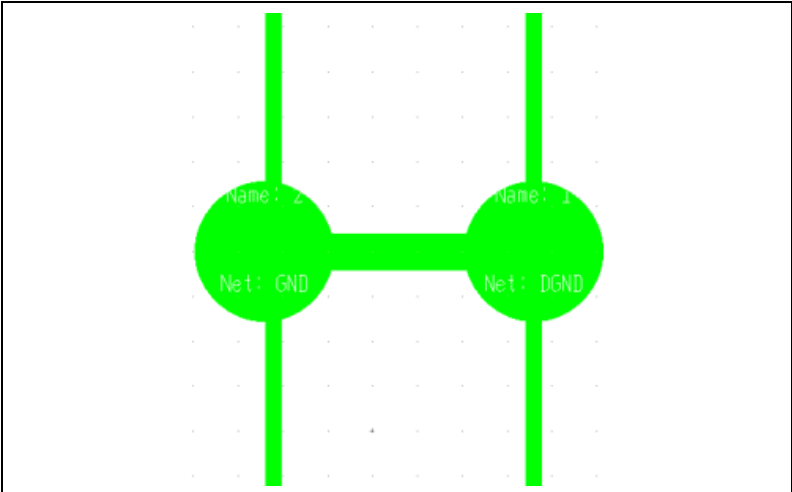

Copying a Copper Route

You can copy the routing of traces between two identical parts groups that have been set up using the **Group Replica** command.

Complete the following steps to copy copper routing between groups:

- 1. Create two identical part groups. Refer to the *Replicating a Group* section of Chapter 4, *Working with Parts*, for more information.
- 2. Route the traces for one of the groups. In the example below, Part Group A consists of U7 and U8. Part Group B consists of U9 and U10.

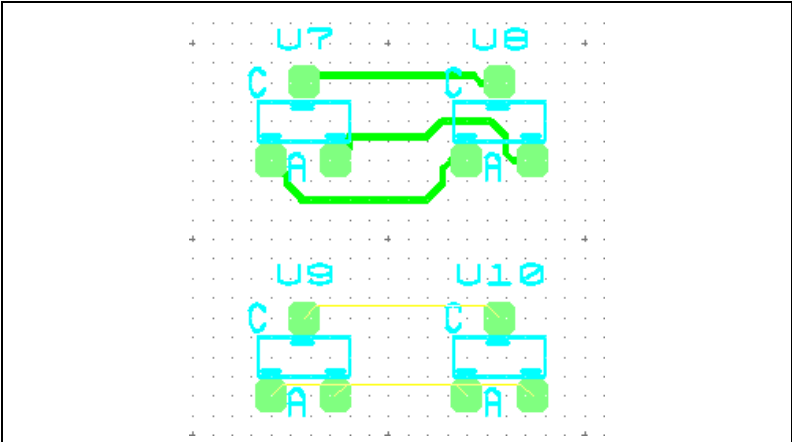

3. Select **Design»Copy Route**. The **Copy route** dialog box appears.
4. Select the group you have already routed in the **Source group** field, and the group you wish to have the same routing in the **Destination group** field and click **OK**. The routing is duplicated for the destination group.

Swapping Pins and Gates

Pin and gate swapping are done between like pins and gates to reduce the amount of copper needed to route a given net.

The following sections document manual pin swapping, manual gate swapping and automatic pin/gate swapping. For these functions to work, the pin groups must be set up in the **Footprint** tab of the **Component Properties** dialog box in Multisim, before the circuit is exported to Ultiboard. Refer to the *Multisim User Manual* for details.

Swapping Pins

This feature works between allowed pins in the same gate (section of an IC). Swapping of pins between gates in the same IC or between similar ICs is not allowed.

Complete the following steps to swap pins between gates:

1. Select **Design»Swap Pins**.
2. Click on the first pin that you wish to swap.

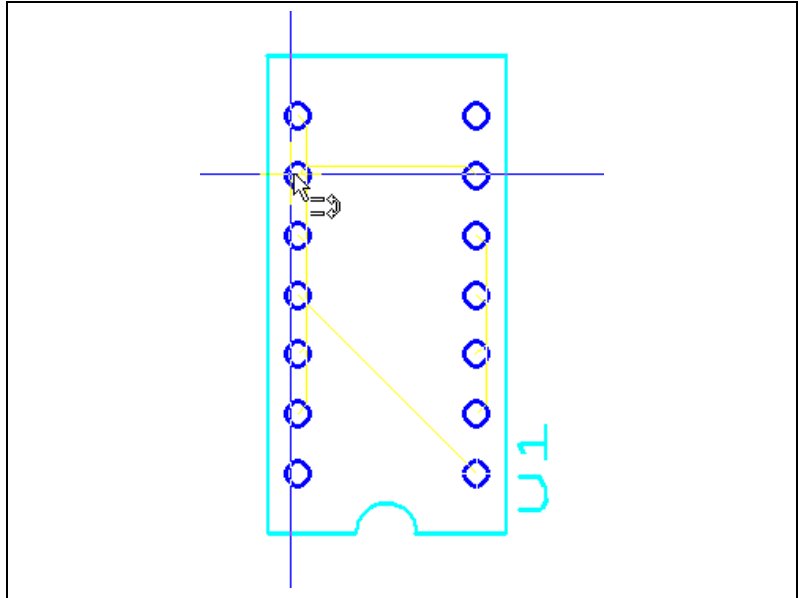

3. Click on the second pin to complete the action.



Note Error messages will display if the selected pins cannot be swapped, or if there is no PINGROUP information for a pin.

Swapping Gates

This feature allows you to swap similar gates, and works for the following, which are set in the **Pin & Gate Swapping Settings** area of the **Design Rules** tab of the **PCB Properties** dialog box:

- **Internal Gates Only**—Allows gate swapping in the same IC only.
- **Advanced Swapping**—Allows gate swapping internally and between similar ICs.

Group settings for swappable gates can be set into part groups in Ultiboard. Each new part group will have its own swapping information, which Ultiboard will follow.

The following design is used in this example:

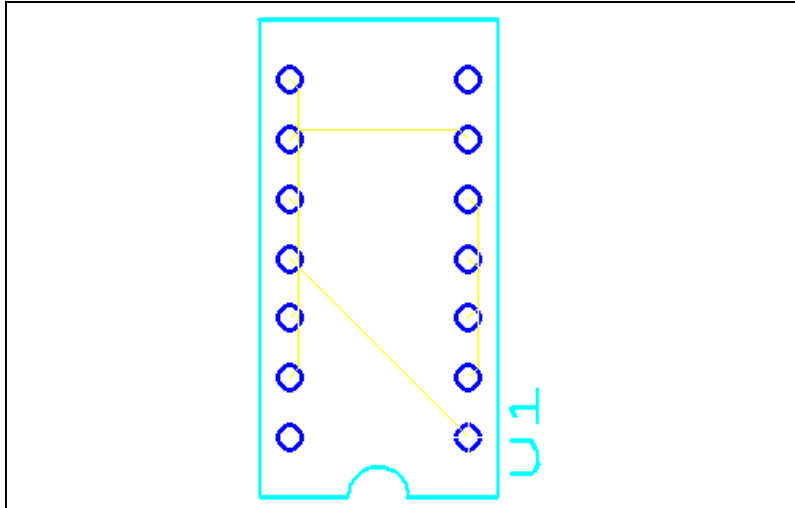

Complete the following steps to swap gates between parts:

1. Select **Design»Swap Gates**. The workspace changes to reflect the gates.

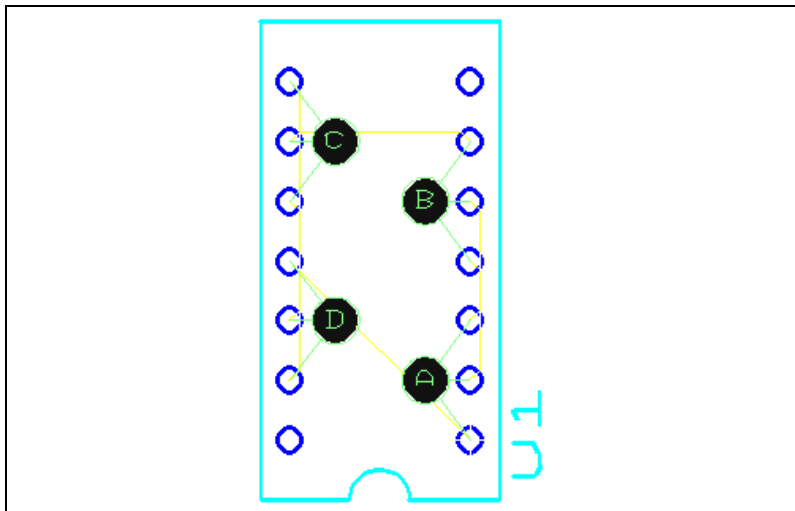

2. Select the first gate that you wish to swap by clicking on the corresponding letter.

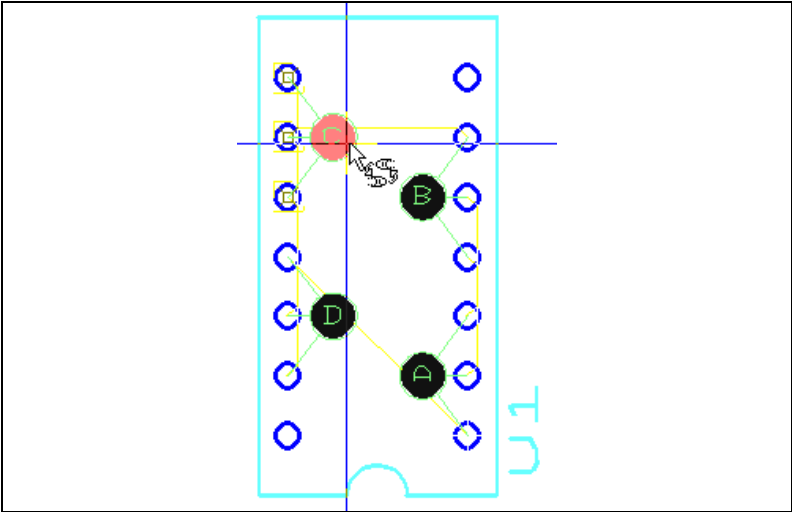

- 3. Click on the letter corresponding to the gate with which you want to exchange the gate you selected above. The ratsnest changes to reflect the swap.

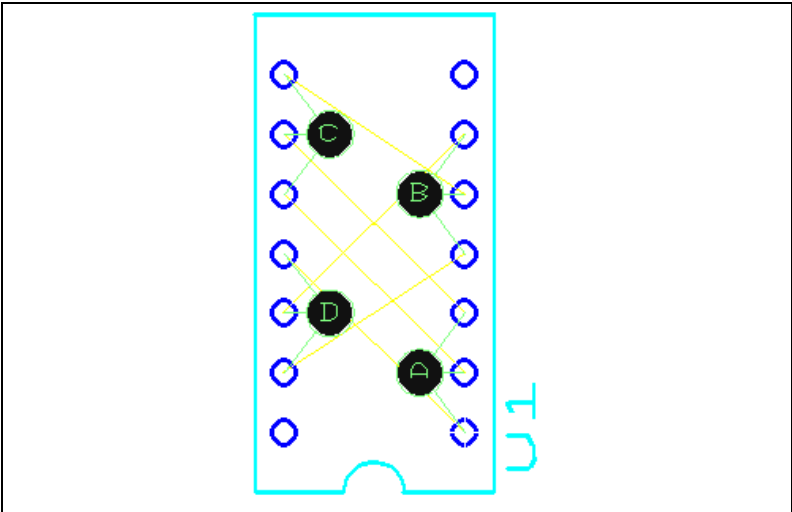

Automatic Pin/Gate Swapping

This feature lets you swap pins and/or gates after moving part(s) on the workspace.



Note For this feature to function, you must allow pin/gate swapping in the **Spreadsheet View**, and in the **Design Rules** tab of the **PCB properties** dialog box.

Complete the following steps to swap pins and gates automatically after a part move:

1. Move desired parts on the workspace.
2. Select **Design»Automatic Pin Gate Swap**. Pins and gates are swapped to achieve the most efficient routing of nets possible.

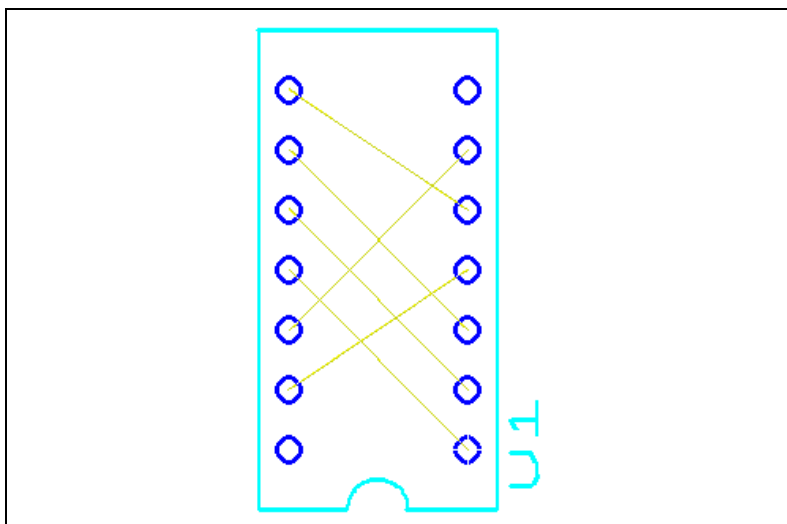

The above figure shows U1 before the automatic pin/gate swap. Note the position of the ratsnests.

The figure below shows U1 after the automatic pin/gate swap. Note the new position of the ratsnests.

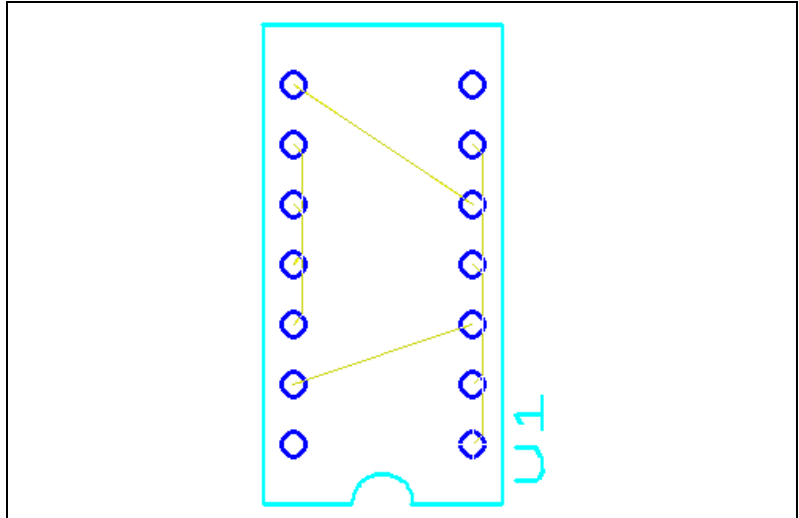

Real-Time Pin/Gate Swapping

This feature allows you to swap pins and/or gates automatically in real-time as you move parts on the workspace.



Note For this feature to function, you must allow pin/gate swapping in the **Spreadsheet View**, and allow real-time swapping in the **Design Rules** tab of the **PCB properties** dialog box.

PCB Calculators

The following sections explain how to use Ultiboard's **PCB Calculators**.

Some of the described features may not be available in your edition of Ultiboard. Refer to the NI Circuit Design Suite Release Notes for a list of the features in your edition.

PCB Transmission Line Calculator

To control reflections on high-speed PCBs, it is necessary to make the traces appear as if they are transmission lines. This is done by calculating the characteristic impedance of the trace (Z_0) and then terminating it with its characteristic impedance. This makes the trace appear like an infinitely long transmission line, and it will therefore have no reflections, even though in reality it has a finite length. (What actually occurs is that all of the energy that travels down the trace is absorbed, and there is no energy left to reflect back). Once you have calculated Z_0 , you can use it to design the trace's termination.

There are a number of methods used to terminate transmission lines, for example, series termination, diode termination, which are beyond the scope of this manual. We recommend that you refer to any number of available texts on the subject.



Note Equations used are based on the IPC-D-317A document from the IPC organization (www.ipc.org).

In addition to Characteristic Impedance (Z_0), you can use the **PCB Transmission Line Calculator** to calculate the following parameters for typical printed circuit board trace geometries:

- Per unit length Capacitance (C_0)
- Per unit length Inductance (L_0)
- Propagation Delay (tpd).

The **PCB Transmission Line Calculator** supports:

- *Microstrip Trace Calculations.*
- *Embedded Microstrip Trace Calculations.*
- *Centered Stripline Trace Calculations.*
- *Asymmetric Stripline Trace Calculations.*
- *Dual Stripline Trace Calculations.*

Microstrip Trace Calculations

Complete the following steps to perform microstrip trace calculations:

1. Select **Tools»PCB Transmission Line Calculator**.
2. Select **Microstrip** in the **Type** drop-down list.
3. In the **Input Data** area, edit the following fields as desired.
 - **Input Length Unit**—Select mils or millimeters.
 - **Dielectric Thickness (H)**—Refer to the figure below.
 - **Trace Thickness (T)**—Refer to the figure below.
 - **Trace Width (W)**—Refer to the figure below.
 - **Relative Permittivity (epsilon r)**—Refer to the figure below.

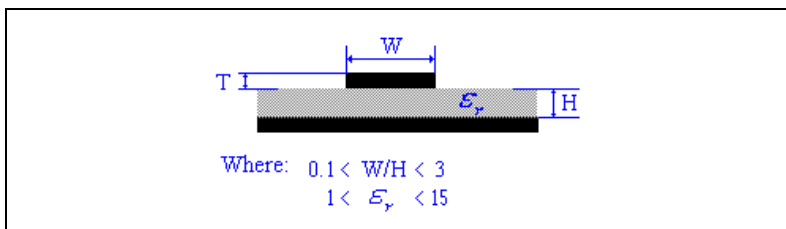

4. Click **Calculate**. Results of the calculation appear in the **Calculation Results** area. They also appear in the **Results** tab of the **Spreadsheet View**.
5. Click **Close** to close the **PCB Transmission Line Calculator**.

Microstrip Equations

The equations used to perform the microstrip calculations are:

$$Z_0 = 87 / (\sqrt{\epsilon_r + 1.41}) * \ln(5.98 * H / (0.8 * W + T))$$

$$T_{pd} = 58.35247 * \sqrt{\epsilon_r + 1.41}$$

$$C_0 = T_{pd} / Z_0$$

$$L_0 = C_0 * Z_0 * Z_0$$

Embedded Microstrip Trace Calculations

Complete the following steps to perform embedded microstrip trace calculations:

1. Select **Tools»PCB Transmission Line Calculator**.
2. Select **Embedded Microstrip** in the **Type** drop-down list.
3. In the **Input Data** area, edit the following fields as desired.
 - **Input Length Unit**—Select mils or millimeters.
 - **Dielectric Height (H1)**—Refer to the figure below.
 - **Dielectric Thickness (H)**—Refer to the figure below.
 - **Trace Thickness (T)**—Refer to the figure below.
 - **Trace Width (W)**—Refer to the figure below.
 - **Relative Permittivity (epsilon r)**—Refer to the figure below.

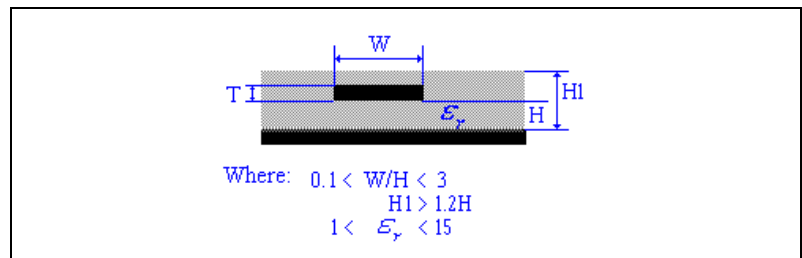

4. Click **Calculate**. Results of the calculation appear in the **Calculation Results** area. They also appear in the **Results** tab of the **Spreadsheet View**.
5. Click **Close** to close the **PCB Transmission Line Calculator**.

Embedded Microstrip Equations

The equations used to perform the embedded microstrip calculations are:

$$Z_0 = 56 * \ln(5.98 * H / (0.8 * W + T)) / \sqrt{\epsilon_r * (1 - \exp(-1.55 * H_1 / H))}$$

$$T_{pd} = 84.66667 * \sqrt{\epsilon_r * (1 - \exp(-1.55 * H_1 / H))}$$

$$C_0 = T_{pd} / Z_0$$

$$L_0 = C_0 * Z_0 * Z_0$$

Centered Stripline Trace Calculations

Complete the following steps to perform centered stripline trace calculations:

1. Select **Tools»PCB Transmission Line Calculator**.
2. Select **Centered Stripline** in the **Type** drop-down list.
3. In the **Input Data** area, edit the following fields as desired:
 - **Input Length Unit**—Select mils or millimeters.
 - **Dielectric Thickness (H)**—Refer to the figure below.
 - **Trace Thickness (T)**—Refer to the figure below.
 - **Trace Width (W)**—Refer to the figure below.
 - **Relative Permittivity (epsilon r)**—Refer to the figure below.

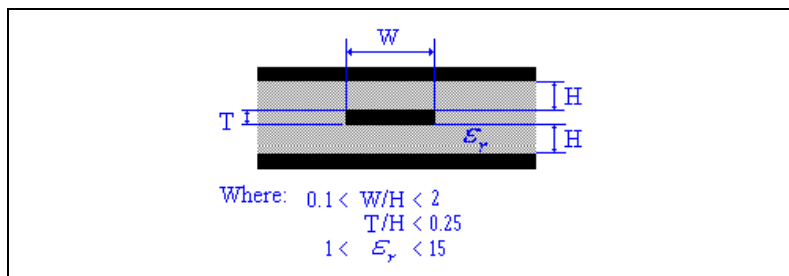

4. Click **Calculate**. Results of the calculation appear in the **Calculation Results** area. They also appear in the **Results** tab of the **Spreadsheet View**.
5. Click **Close** to close the **PCB Transmission Line Calculator**.

Centered Stripline Equations

The equations used to perform the centered stripline calculations are:

$$Z_0 = 60 * \ln(4 * (2 * H + T) / (0.67 * 3.1415926 * (0.8 * W + T))) / \sqrt{\epsilon_r}$$

$$T_{pd} = 84.66667 * \sqrt{\epsilon_r}$$

$$C_0 = T_{pd} / Z_0$$

$$L_0 = C_0 * Z_0 * Z_0$$

Asymmetric Stripline Trace Calculations

Complete the following steps to perform asymmetric stripline trace calculations:

1. Select **Tools»PCB Transmission Line Calculator**.
2. Select **Asymmetric Stripline** in the **Type** drop-down list.
3. In the **Input Data** area, edit the following fields as desired:
 - **Input Length Unit**—Select mils or millimeters.
 - **Dielectric Height (H1)**—Refer to the figure below.
 - **Dielectric Height (H)**—Refer to the figure below.
 - **Trace Thickness (T)**—Refer to the figure below.
 - **Trace Width (W)**—Refer to the figure below.
 - **Relative Permittivity (epsilon r)**—Refer to the figure below.

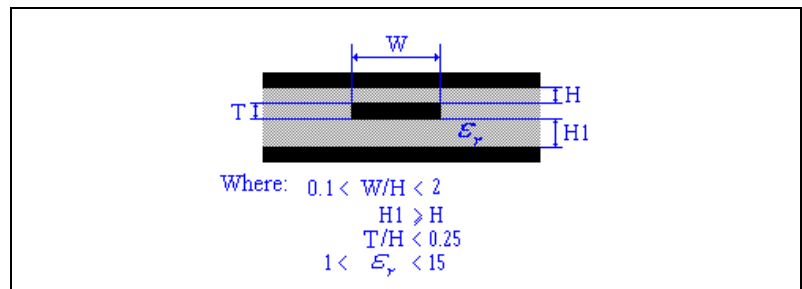

4. Click **Calculate**. Results of the calculation appear in the **Calculation Results** area. They also appear in the **Results** tab of the **Spreadsheet View**.
5. Click **Close** to close the **PCB Transmission Line Calculator**.

Assymmetric Stripline Equations

The equations used to perform the asymmetric stripline calculations are:

$$Z_0 = (1 - H/(4 * H1)) * 80 * \ln(4 * (2 * H + T) / (0.67 * 3.1415926 * (0.8 * W + T))) / \sqrt{\epsilon_r}$$

$$T_{pd} = 84.66667 * \sqrt{\epsilon_r}$$

$$C_0 = T_{pd} / Z_0$$

$$L_0 = C_0 * Z_0 * Z_0$$

Dual Stripline Trace Calculations

Complete the following steps to perform centered stripline trace calculations:

1. Select **Tools»PCB Transmission Line Calculator**.
2. Select **Dual Stripline** in the **Type** drop-down list.
3. In the **Input Data** area, edit the following fields as desired:
 - **Input Length Unit**—Select mils or millimeters.
 - **Trace Separation (C)**—Refer to the figure below.
 - **Dielectric Thickness (H)**—Refer to the figure below.
 - **Trace Thickness (T)**—Refer to the figure below.
 - **Trace Width (W)**—Refer to the figure below.
 - **Relative Permittivity (epsilon r)**—Refer to the figure below.

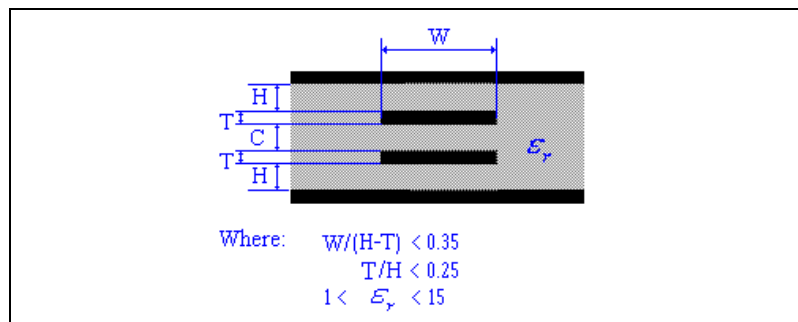

4. Click **Calculate**. Results of the calculation appear in the **Calculation Results** area. They also appear in the **Results** tab of the **Spreadsheet View**.
5. Click **Close** to close the **PCB Transmission Line Calculator**.

Dual Stripline Equations

The equations used to perform the dual stripline calculations are:

$$Z_0 = 30 * (\ln(8 * H / (0.67 * 3.1415926 * (0.8 * W + T))) + \ln(8 * (H + C) / (0.67 * 3.1415926 * (0.8 * W + T)))) / \sqrt{\text{Er}}$$

$$T_{pd} = 84.66667 * \sqrt{\text{Er}}$$

$$C_0 = T_{pd} / Z_0$$

$$L_0 = C_0 * Z_0 * Z_0$$

PCB Differential Impedance Calculator

To control reflections on high-speed PCBs, it is necessary to make the traces appear as if they are transmission lines. This is done by calculating the characteristic impedance of the trace (Z_0) and then terminating it with its characteristic impedance. This makes the trace appear like an infinitely long transmission line, and it will therefore have no reflections, even though in reality it has a finite length. (What actually occurs is that all of the energy that travels down the trace is absorbed, and there is no energy left to reflect back.) Once you have calculated Z_0 , you can use it to design the trace's termination.

If two traces in a differential pair are placed closely together, the differential impedance (Z_{diff}) of the pair must be calculated for proper trace termination. (This is the Differential Impedance Rule.)

There are a number of methods used to terminate transmission lines, for example, series termination, diode termination, which are beyond the scope of this manual. We recommend that you refer to any number of available texts on the subject.



Note Equations used are based on the IPC-D-317A document from the IPC organization (www.ipc.org).

The **PCB Differential Impedance Calculator** performs calculations for two traces that carry signals that are exactly equal and opposite (a differential pair).

You can use the **PCB Differential Impedance Calculator** to calculate the following parameters for differential pairs:

- Characteristic Impedance (Z_0).
- Per unit length Capacitance (C_0).
- Per unit length Inductance (L_0).
- Propagation Delay (tpd).
- Differential Impedance (Z_{diff}).

The **PCB Differential Impedance Calculator** supports:

- Microstrip Calculations.
- [Embedded Microstrip Calculations](#).
- [Centered Stripline Calculations](#).
- [Asymmetric Stripline Calculations](#).

Microstrip Calculations

Complete the following steps to perform microstrip differential impedance calculations:

1. Select **Tools»PCB Differential Impedance Calculator**.
2. Select **Microstrip** in the **Type** drop-down list.
3. In the **Input Data** area, edit the following fields as desired:
 - **Input Length Unit**—Select mils or millimeters.
 - **Dielectric Thickness (H)**—Refer to the figure below.
 - **Trace Thickness (T)**—Refer to the figure below.
 - **Trace Width (W)**—Refer to the figure below.
 - **Trace Spacing (S)**—Refer to the figure below.
 - **Relative Permittivity (epsilon r)**—Refer to the figure below.

Or

If you wish to define the Characteristic Impedance (Z_0) yourself, click **User Defined Z_0** and edit the following fields as desired:

- **Input Length Unit**—Select mils or millimeters.
- **Dielectric Thickness (H)**—Refer to the figure below.
- **Trace Spacing (S)**—Refer to the figure below.
- **Characteristic Impedance (Z_0)**—Refer to the figure below.

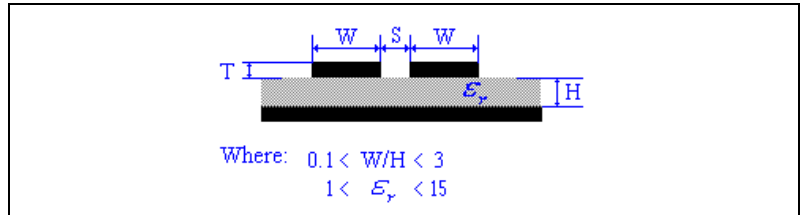

- Click **Calculate**. Results of the calculation appear in the **Calculation Results** area. They also appear in the **Results** tab of the **Spreadsheet View**.



Note If you chose **User Defined Zo** in the previous step, the **Per Length Unit** and the **Differential Impedance** are the only values that appear in the **Calculation Results** area of the **PCB Differential Impedance Calculator** dialog and the **Results** tab when you click **Calculate**.

- Click **Close** to close the **PCB Differential Impedance Calculator**.

Microstrip Differential Impedance Equations

The equations used to perform the microstrip differential impedance calculations are:

$$Z_0 = 87 / (\sqrt{\epsilon_r + 1.41}) * \ln(5.98 * H / (0.8 * W + T))$$

$$T_{pd} = 58.35247 * \sqrt{\epsilon_r + 1.41}$$

$$C_0 = T_{pd} / Z_0$$

$$L_0 = C_0 * Z_0 * Z_0$$

$$Z_{diff} = 2 * Z_0 * (1 - 0.48 * \exp(-0.96 * S / H))$$

Embedded Microstrip Calculations

Complete the following steps to perform embedded microstrip differential impedance calculations:

- Select **Tools»PCB Differential Impedance Calculator**.
- Select **Embedded Microstrip** in the **Type** drop-down list.
- In the **Input Data** area, edit the following fields as desired.
 - Input Length Unit**—Select mils or millimeters.
 - Dielectric Height (H1)**—Refer to the figure below.

- **Dielectric Thickness (H)**—Refer to the figure below.
- **Trace Thickness (T)**—Refer to the figure below.
- **Trace Width (W)**—Refer to the figure below.
- **Trace Spacing (S)**—Refer to the figure below.
- **Relative Permittivity (epsilon r)**—Refer to the figure below.

Or

If you wish to define the Characteristic Impedance (Z_0) yourself, click **User Defined Z_0** and edit the following fields as desired:

- **Input Length Unit**—Select mils or millimeters
- **Dielectric Thickness (H)**—Refer to the figure below.
- **Trace Spacing (S)**—Refer to the figure below.
- **Characteristic Impedance (Z_0)**—Refer to the figure below.

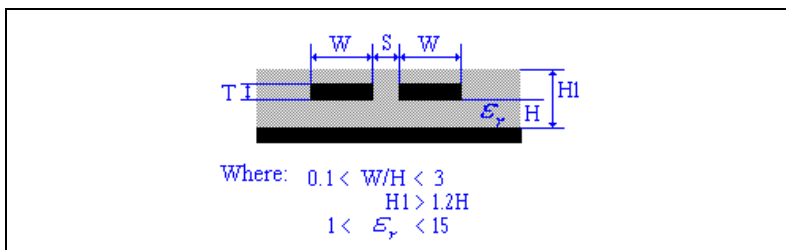

4. Click **Calculate**. Results of the calculation appear in the **Calculation Results** area. They also appear in the **Results** tab of the **Spreadsheet View**.



Note If you chose **User Defined Z_0** in the previous step, the **Per Length Unit** and the **Differential Impedance** are the only values that appear in the **Calculation Results** area of the **PCB Differential Impedance Calculator** dialog and the **Results** tab when you click **Calculate**.

5. Click **Close** to close the **PCB Differential Impedance Calculator**.

Embedded Microstrip Differential Impedance Equations

The equations used to perform the embedded microstrip differential impedance calculations are:

$$Z_0 = 56 * \ln(5.98 * H / (0.8 * W + T)) / \sqrt{\text{Er} * (1 - \exp(-1.55 * H / H))}$$

$$T_{pd} = 84.66667 * \sqrt{\text{Er} * (1 - \exp(-1.55 * H / H))}$$

$$C_0 = T_{pd} / Z_0$$

$$L_0 = C_0 * Z_0 * Z_0$$

$$Z_{diff} = 2 * Z_0 * (1 - 0.48 * \exp(-0.96 * S / H))$$

Centered Stripline Calculations

Complete the following steps to perform centered stripline differential impedance calculations:

1. Select **Tools»PCB Differential Impedance Calculator**.
2. Select **Centered Stripline** in the **Type** drop-down list.
3. In the **Input Data** area, edit the following fields as desired:
 - **Input Length Unit**—Select mils or millimeters.
 - **Dielectric Thickness (H)**—Refer to the figure below.
 - **Trace Thickness (T)**—Refer to the figure below.
 - **Trace Width (W)**—Refer to the figure below.
 - **Trace Spacing (S)**—Refer to the figure below.
 - **Relative Permittivity (epsilon r)**—Refer to the figure below.

Or

If you wish to define the Characteristic Impedance (Z_0) yourself, click **User Defined Z_0** and edit the following fields as desired:

- **Input Length Unit**—Select mils or millimeters.
- **Dielectric Thickness (H)**—Refer to the figure below.
- **Trace Spacing (S)**—Refer to the figure below.
- **Characteristic Impedance (Z_0)**—Refer to the figure below.

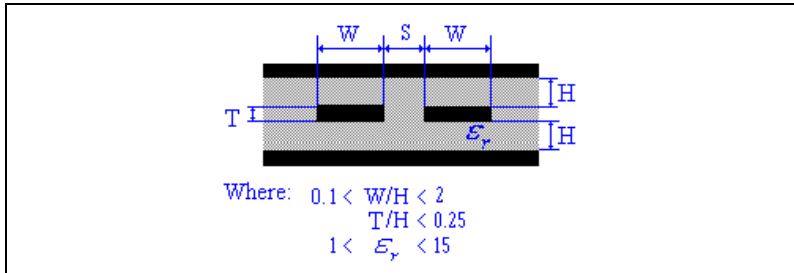

- Click **Calculate**. Results of the calculation appear in the **Calculation Results** area. They also appear in the **Results** tab of the **Spreadsheet View**.



Note If you chose **User Defined Zo** in the previous step, the **Per Length Unit** and the **Differential Impedance** are the only values that appear in the **Calculation Results** area of the **PCB Differential Impedance Calculator** dialog and the **Results** tab when you click **Calculate**.

- Click **Close** to close the **PCB Differential Impedance Calculator**.

Centered Stripline Differential Impedance Equations

The equations used to perform the centered stripline differential impedance calculations are:

$$Z_0 = 60 \cdot \ln(4 \cdot (2 \cdot H + T) / (0.67 \cdot 3.1415926 \cdot (0.8 \cdot W + T))) / \sqrt{\epsilon_r}$$

$$T_{pd} = 84.66667 \cdot \sqrt{\epsilon_r}$$

$$C_0 = T_{pd} / Z_0$$

$$L_0 = C_0 \cdot Z_0 \cdot Z_0$$

$$Z_{diff} = 2 \cdot Z_0 \cdot (1 - 0.347 \cdot \exp(-2.9 \cdot S / (2 \cdot H + T)))$$

Asymmetric Stripline Calculations

Complete the following steps to perform asymmetric stripline differential impedance calculations:

- Select **Tools»PCB Differential Impedance Calculator**.
- Select **Asymmetric Stripline** in the **Type** drop-down list.

3. In the **Input Data** area, edit the following fields as desired:
 - **Input Length Unit**—Select mils or millimeters.
 - **Dielectric Height (H1)**—Refer to the figure below.
 - **Dielectric Height (H)**—Refer to the figure below.
 - **Trace Thickness (T)**—Refer to the figure below.
 - **Trace Width (W)**—Refer to the figure below.
 - **Trace Spacing (S)**—Refer to the figure below.
 - **Relative Permittivity (epsilon r)**—Refer to the figure below.

Or

If you wish to define the Characteristic Impedance (Z_0) yourself, click **User Defined Z_0** and edit the following fields as desired:

- **Input Length Unit**—Select mils or millimeters.
- **Dielectric Thickness (H)**—Refer to the figure below.
- **Trace Spacing (S)**—Refer to the figure below.
- **Characteristic Impedance (Z_0)**—Refer to the figure below.

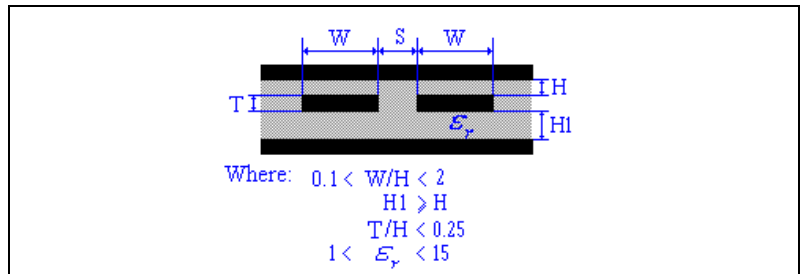

4. Click **Calculate**. Results of the calculation appear in the **Calculation Results** area. They also appear in the **Results** tab of the **Spreadsheet View**.



Note If you chose **User Defined Z_0** in the previous step, the **Per Length Unit** and the **Differential Impedance** are the only values that appear in the **Calculation Results** area of the **PCB Differential Impedance Calculator** dialog and the **Results** tab when you click **Calculate**.

5. Click **Close** to close the **PCB Differential Impedance Calculator**.

Asymmetric Stripline Differential Impedance Equations

The equations used to perform the asymmetric stripline differential impedance calculations are:

$$Z_0 = \frac{(1 - H/(4 * H1)) * 80 * \ln(4 * (2 * H + T) / (0.67 * 3.1415926 * (0.8 * W + T)))}{\sqrt{Er}}$$

$$T_{pd} = 84.66667 * \sqrt{Er}$$

$$C_0 = T_{pd} / Z_0$$

$$L_0 = C_0 * Z_0 * Z_0$$

$$Z_{diff} = 2 * Z_0 * (1 - 0.347 * \exp(-2.9 * S / (H + H1 + T)))$$

Autorouting and Autoplacement

There are a number of autorouting and autoplacement tools that vary depending on your edition of Ultiboard. These tools offer advanced autoplacement with state-of-the-art autorouting for optimal layout of your printed circuit boards, and are fully integrated with Ultiboard.

For details on the autorouting and autoplacement features found in your edition of Ultiboard, refer to the release notes.

Autoroute Menu Items

Ultiboard's autoplacement and autorouting functions are accessed through the **Autoroute** menu.

Autoroute»Start/Resume Autorouter

Use to start or resume the autorouter. Refer to the [Running the Autorouter](#) section for more information.

Autoroute»Stop/Pause Autorouter

Use to stop or pause the autorouter.

Autoroute»Start Autoplacement

Use to autoplacement parts on your PCB. Refer to the [Running the Autoplacer](#) section for more information.

Autoroute»Autoplace Selected Parts

Use to place part(s) that you have selected on the workspace.

Autoroute»Autoroute Selected Parts

Use for routing of all nets for the selected parts. Refer to the [Pre-Placing Parts](#) section for more information.

Autoroute»Autoroute Selected Nets

Use to route net(s) that you have selected on the workspace.



Note This is only active when an unconnected pad corresponding to that net is selected.

Autoroute»Autoroute Selected Buses

Use to autoroute selected buses. Refer to the [Autorouting buses](#) section for more information.

Autoroute»Start Optimization

Use to optimize the placement of traces. Refer to the [Optimization](#) section for more information.

Autoroute»Autoroute/place Options

Use to set up router and placer functions. Refer to the [Controlling the Routing Functions](#) and [Controlling the Autoplacer](#) sections for more information.

Autoplacement of Parts

The following sections explain how to use the autoplacer to place parts.

Pre-Placing Parts

You may wish to pre-place certain parts (for example, holes) before autoplacing other parts.

Complete the following steps to lock any pre-placed parts so they will not be moved by the autoplacer:

1. Select the pre-placed parts and choose **Edit»Lock**.
2. You can also lock parts in place from the **Parts** tab of the **Spreadsheet View**. Refer to the [Spreadsheet View: Parts Tab](#) section of Chapter 1, [User Interface](#), for more information.

Understanding How the Autoplacer Works

The autoplacer automatically places all unplaced parts onto your board according to group settings you can specify. It uses a rip-up and retry algorithm to find the best part positioning. As the autoplacer runs, the status line at the bottom of the screen indicates how many autoplacement passes have been completed. It also indicates how many parts have been placed and how many pins have been swapped (when the autoplacer performs pin/gate swaps). If the autoplacer cannot place all the parts, it returns a message indicating how many parts are still unplaced in the **Results** tab of the **Spreadsheet View**.

The autoplacer places parts as clusters. These clusters are generated by grouping a multi-pin part with a series of connected parts, each of which has fewer than four pins. Each cluster is then assigned a placement priority. By arranging parts into clusters, the autoplacer can place together those parts that have multiple connections. Block capacitors, which are connected to power signals, are always excluded from clusters. Ultiboard uses automatic block capacitor recognition to place block capacitors close to their corresponding ICs.

Running the Autoplacer

To run the autoplacer, select **Autoroute»Start Autoplacement**.

To place only selected parts, selected **Autoroute»Autoplace Selected Parts**.

To view the results of any autoplacement, select the **Results** tab of the **Spreadsheet View**.

Refer to the *Controlling the Autoplacer* section for information about autoplaced parameters.

Controlling the Autoplacer

The autoplacer is controlled from the **Autoplace** tab of the **Routing Options** dialog box.

Complete the following steps to enter autoplacer settings:

1. Select **Autoroute»Autoroute/place Options**.
2. Click on the **Autoplace** tab of the **Routing Options** dialog box.
3. In the **Retries** area:
 - **Number of Retries**—Enter a number from 1 to 10. This number represents the portion of parts that will be placed in each pass. For example, if set to “3”, the placer attempts to place one third of the parts, then the next third, and so on.
4. In the **Cost Factors** area:
 - **Part Pin Factor**—Use to control cluster placement. When determining which part should be placed next, the cluster placer looks for a part that has many connections to parts that have already been placed. This part can be either the one with the most pins or with the greatest percentage of pins connected to parts that have already been placed. Enter a number from 0 to 10. 0 prioritizes parts with the highest absolute number of pin

connections. 10 prioritizes parts with the highest ratio of connections to total pins. A high part pin factor value usually results in a better distribution of nets than a low value. However, high values may cause excessive placement area fragmentation on high-density layouts by placing small parts prematurely and preventing you from placing larger ones later on.

- **Segment Fit**—Use to control the extent to which the autoplacer puts parts with equal lengths side by side. Placing parts with similar lengths beside each other results in neater and more professional looking board layouts. It may also improve the routability of the board by aligning the parts with bus connections. However, for high-density boards with few bus connections, aligning parts with similar lengths will not necessarily produce better routing results. Enter a number from 0 to 10. If you enter 0, there is no segment fit preference, so the autoplacer will not place parts with similar lengths beside each other. 10 indicates a strong preference for aligning parts with equal edge lengths, so the autoplacer will place parts with similar lengths beside each other whenever possible.

5. In the **Parts** area:

- **Part Rotation Mode**—Determines how much the autoplacer is able to rotate through-hole technology parts when placing them. In general, when you restrict part rotation, you simplify your part placement, consume less CPU time, and create a layout that is easy to change later. However, when you choose unrestricted part rotation, you may end up with a much more efficient board layout than you would get with no part rotation. Select one of: **None**, for no rotation; **90 Deg**, for 90 clockwise rotation of all autoplaced parts; **0 or 90 Deg**, to have parts either not rotate, or rotate 90 clockwise; **90 Deg Steps**, to have parts rotate either 90, 180, or 270 degrees clockwise.
- **SMD Mirroring**—Lets you place surface mounted devices (SMDs) on both the top and bottom sides of a board and relax the part spacing. You can place SMDs on both the “parts” and the “solder” sides of your boards using mirroring mode. Select **Yes** to allow mirroring of all SMD parts or **2-Pin Parts Only** to allow only SMD parts with two pins to be placed on the solder side of the board.

- **SMD Rotation Mode**—Used to set amount by which surface-mount parts can be rotated during autoplacement. Select one of **None**, for no rotation; **90 Deg**, for 90 clockwise rotation of all autoplaced SMD parts; **0 or 90 Deg**, to have parts either not rotate, or rotate 90 clockwise; **90 Deg Steps**, to have parts rotate either 90, 180, or 270 degrees clockwise.
 - **Global Part Spacing**—Enter the minimum allowed space between parts.
6. In the **Miscellaneous** area:
 - **Use Pin/Gate Swap**—Check to enable pin/gate swapping during autoplacement of parts. Exchanges the nets of gates and/or pins and pin groups, where gates or groups can also be swapped between different parts.
 - **Use Part Swap**—Check to enable part swapping during autoplacement of parts. Mutually exchanges identical parts at their insertion position in order to minimize trace lengths.
 7. Click **OK** to apply settings.
 8. If you wish to return the values to the default settings, click **Default**.



Caution The **Default** button sets default values for all tabs in the **Routing Options** dialog box.

Strategies to Achieve Better Part Placement

Occasionally, the autoplacer is unable to place all the parts in a design. In this case, try one or more of the following:

- **Reduce the part spacing.** As part expansion values get larger, the area in which the autoplacer can place parts gets smaller. Reducing the part spacing allows the autoplacer to pack parts more densely.
- **Use part rotation.** If you restrict part rotation, the autoplacer is not able to reorient the parts for the most efficient fit on the board. Use a less restrictive rotation mode setting to allow Ultiboard to reorient the parts as necessary.
- **Allow SMD mirroring.** Allows Ultiboard to place parts on both sides of the board. This doubles the area on which the autoplacer can arrange parts, and eases the space requirements on the top side of the board.



Note All of the above are set up in the **Autoplace** tab of the **Routing Options** dialog box. Refer to the [Controlling the Autoplacer](#) section for more information.

- **Use smaller Keep-out or Keep-in areas.** Often, a PCB with Keep-in areas can be designed with an equivalent set of Keep-out areas, or vice-versa. Whenever possible, choose a design strategy that minimizes the total area of the board covered by these Keep-in or Keep-out areas since each area radically decreases the autoplacement algorithms' effectiveness.
- **With very dense boards, the last few parts may need to be hand-placed.** The autoplacement algorithms have been carefully tuned to optimize the routability of the final layout, rather than trying to pack all the parts into the smallest possible area. If the autoplacer places all but one or two parts, it may be faster to simply place them on the board by hand—using Ultiboard's part shoving facility (not available in all versions) to ensure that parts do not overlap—than to spend time trying to tune the autoplacement parameters to achieve complete placement.

Autorouting

The following sections describe the autorouting functions in Ultiboard.

Understanding How the Autorouter Works

Ultiboard contains four fundamental trace-routing functions:

- router preprocessing
- initial routing
- rip-up and retry passes
- optimization.

Ultiboard uses combinations of these functions to route a board. They are described in the [Understanding the Four Fundamental Routing Functions](#) section. Information on how to use these functions can be found in the [Running the Autorouter](#) section.

Understanding the Four Fundamental Routing Functions

The following sections describe the four fundamental routing functions used by Ultiboard.

Router Preprocessing

Before routing begins, Ultiboard analyzes the entire board, considering trace widths, clearances, Keep-in, and Keep-out areas. The preprocessor then adapts the router parameters and algorithms best suited for this particular board, for example, routing grid size, pin clearance algorithms, and connection routing order.



Note The routing algorithms use their own internal routing grid, which is not related to Ultiboard's grid.

Initial Routing

Initial routing automatically routes as many traces as possible in a single pass without any rip-up and retry operations.

Ultiboard uses trace hugging to place traces as close together as possible, and close to obstacles. It also uses copper sharing where appropriate, for example, in a T-junction.

Rip-up and Retry Routing

The rip-up and retry router attempts to route all open connections. In some cases, Ultiboard can place all traces in a single pass without rerouting any traces. However, if Ultiboard does not achieve 100 percent completion, then the rip-up and retry router rips up selected traces and reroutes them to make room for other traces that could not be placed during the first pass.

The rip-up and retry router is guarded by a backtracking algorithm, which not only prevents routing deterioration or deadlock during rip-up and optimization, but is able to exploit better routing solutions. The rip-up and retry router automatically activates an intermediate optimizer if a single rip-up pass does not achieve 100 percent routing success.

Part of Ultiboard's rip-up and retry procedure is to analyze dense board areas and adopt routing strategies in these areas, which decrease manufacturing costs. The cost factors Ultiboard uses can be adapted to your current routing problem; thus, you can control the routing strategies that Ultiboard uses and keep production costs within acceptable limits. It is strongly recommended that you do not modify these routing strategies

unless you achieve poorer routing results than you expect. When changing cost factors, even slight adjustments can have large effects on routing success, either improving or worsening the results.

Optimization

The optimizer is usually applied after the autorouter achieves 100% completion. It eliminates unnecessary vias and smooths wire bends to reduce manufacturing costs. It also routes any remaining open connections. You can prevent Ultiboard from calling the optimizer by unchecking **Optimization Pass** in the **General** tab of the **Routing Options** dialog box.

The optimizer can also be run separately by selecting **Autoroute»Start Optimization**. This also optimizes user-placed traces and vias, provided that **Trace can be Moved** is selected in the **General** tab of the trace's properties dialog box. For vias, **Via can be Moved** must be selected in the **Via** tab of the **Via Properties** dialog box.

Routing Selected Parts and Nets

Complete the following to place traces on a selection of parts:

1. Select the desired parts and select **Autoroute»Autoroute Selected Parts**.

Complete the following to route selected nets:

1. Select the desired nets and select **Autoroute»Autoroute Selected Nets**.



Note You can also pre-place traces and vias before running the autorouter. Refer to the *Placing Traces* section of Chapter 5, *Working with Traces and Copper*, for more information. Once a trace is placed, lock it by selecting **Trace is Fixed** in its properties dialog in Ultiboard. Lock vias with **Via is Fixed**. Any traces set this way are treated as locked when you run the autorouter. The autorouter can also be stopped during placement to allow you to place some fixed traces, and then be restarted.

Running the Autorouter

The full autorouter runs an end-to-end autorouting process that includes all four routing functions, applied in the following order:

1. Preprocessing.
2. Initial routing.
3. Rip-up and retry passes.
4. Optimization.

To perform a full autoroute, choose **Autoroute»Start/Resume Autorouter**.

Ultiboard begins routing your board and displays its progress in the status line. When the process is complete the results are displayed in the **Results** tab of the **Spreadsheet View**.

Interactivity

Ultiboard provides complete interactivity, letting you stop the routing process as desired to manually place items and then continue autorouting when ready.

To stop autorouting, select **Autoroute»Stop/Pause Autorouter**.

To restart, select **Autoroute»Start Autoplacement**.

Autorouting buses

The circuit shown below is used in this example. Bus 1 consists of the five nets that connect the two ICs.

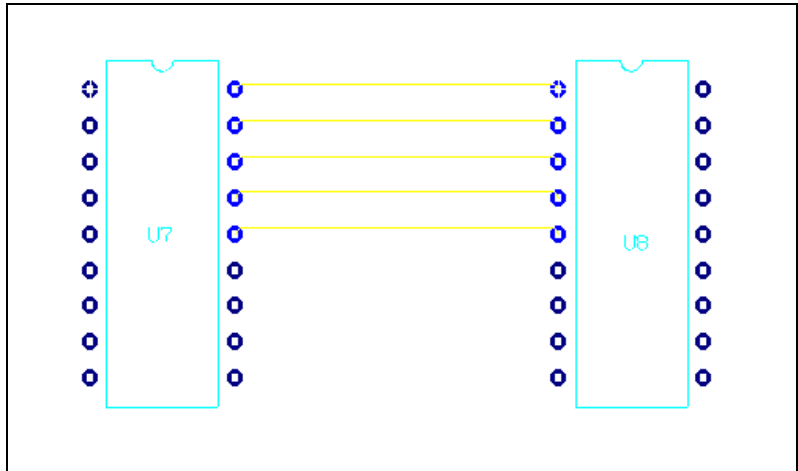

Note To autoroute buses, the topology for the nets, as set in the **Net edit** dialog box, must be set to either **Daisy chain** or **Star** and the nets must be part of a **Bus Group** (in the **Groups** tab of the **Net edit** dialog box). Refer to the [Setting Group Parameters](#) section of Chapter 5, [Working with Traces and Copper](#), for more information.

Complete the following steps to autoroute selected bus(es):

1. Select **Autoroute»Autoroute Selected Buses**. The **Bus autorouting** dialog box displays.
2. Select the desired buses to route in the **Defined bus groups** area and click **OK**. The buses are routed as in the following example.

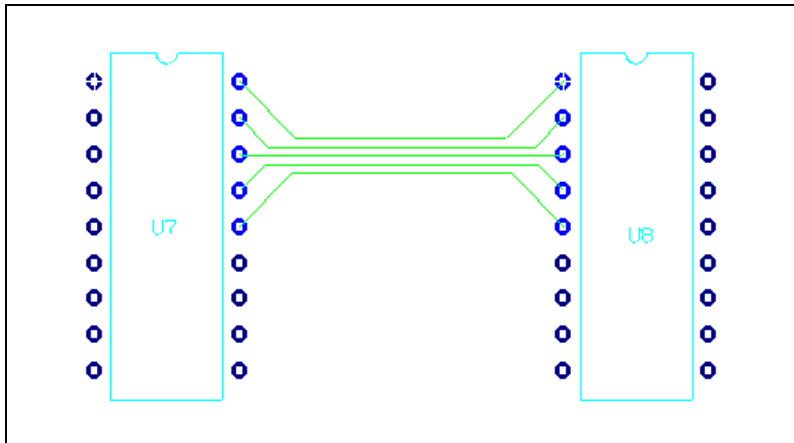

Placing Automatic Test Points

You can automatically place a test point on each net on your design.



Note Testpoints may be placed either before or after autorouting the entire board.

Complete the following steps to automatically place test points:

1. Select **Place»Automatic Test Points**.
2. Enter the following as desired:
 - **Diameter** drop-down list—Sets the wire's diameter. The **Preview** area changes accordingly.
 - **Board Side** radio buttons—Select **Top** or **Bottom** to indicate which side of the PCB the points appear on.
 - **Rotation** drop-down list—Sets the rotation for the test point. The **Preview** area changes accordingly.
 - **Pin Type** box—Choose **Through Hole Technology** or **Surface Mount Technology**.
3. Click **Start**.

4. The **Automatic Testpoint Placement Setup** dialog box disappears and one test point is placed on or near each net on your board. If placed near an existing net, the test point will be automatically connected.
5. Results of testpoint placements, including a list of any nets which the router could not connect, will appear in the **Results** tab of the **Spreadsheet View**. You can click on an error to go to the unrouted testpoint.

Controlling the Routing Functions

Router functions are controlled through the **Routing Options** dialog box, which is displayed when you choose **Autoroute»Autoroute/place Options**.

Routing Options: General Tab

Complete the following steps to set up general routing options:

1. Select the **General** tab in the **Routing Options** dialog box.
2. Complete the following fields in the **Routing** area:
 - **Routing Mode**—Select **Gridbased**, to place the traces on a grid; **Gridless** to place them off the grid; or **Progressive** which will attempt to place the traces on a grid, and then place those that remain off the grid.
 - **Grid Type**—Select **English** - the router grid will be some sensible number of mils (10 mils, 20 mils, etc.); or **Metric** - the router grid will be some sensible number of millimeters (0.2 mm, 0.3 mm, etc.); or **Board Settings** - Ultiboard will choose either English or Metric, depending on the units Ultiboard is using. This setting is independent of the **Routing Mode** setting in the **Routing** area.
 - **Optimization Pass** checkbox—Enable to permit router passes that will optimize the placement of the traces.
3. Complete the following fields in the **Settings** area:
 - **Via Grid**—Select **100 mil standard**, which places the vias on a 100 mil grid; **50 mil standard**, which places the vias on a 50 mil grid; **25 mil standard**, which places the vias on a 25 mil grid; or **None**, which will not place the vias on any grid. The optimal grid size is determined on-the-fly by Ultiboard during the routing process; if it differs from the **Via Grid** setting, vias will be placed at the grid point closest to the 100, 50 or 25 mil setting.

- **Pin Contact Mode**—Select **Allow Pin Corners** to allow traces to connect to pins diagonally.
 - **Place Vias Under SMD Pads**—Select **Yes** or **No** as desired.
 - **Auto Adjust Trace Width** checkbox—Enable to allow the router to narrow the trace to its minimum width as set in the **Nets** tab of the **Spreadsheet View** or the **Width** tab of the **Net edit** dialog box.
 - **Fanout BGA Parts** checkbox—Attaches vias to each pin of all BGA (Ball Grid Array) parts. If the **DRC** checkbox is enabled, a design rules check is performed before fanouts are placed. In cases where attaching a via to a specific pin would violate a design rule, the via is not attached. This does not affect the attachment of vias to pins where there is no design rule violation. Refer to the [Design Rules Tab](#) section of Chapter 1, [User Interface](#), for information about design rules.
 - **Use Pin/Gate Swap** checkbox—Enable to allow pin/gate swapping while routing to swap equivalent pins/gates to result in more optimal trace connections.
4. In the **Screen Refresh During Routing** area, adjust the slider as desired to set the relative number of times the screen is refreshed during routing.
 5. If you wish to return the values to the default settings for Ultiboard, click **Default**.



Caution The **Default** button sets default values for all tabs in the **Routing Options** dialog box.

Routing Options: Cost Factors Tab

You may adjust cost factor settings to control how the router “costs” its various routing strategies.

The default values are chosen carefully to give you the best balance of routing characteristics, except in exceptional circumstances. In general, leave the cost factors at their default values unless the autorouter is not producing the results you want. Any adjustments that are not carefully considered can actually worsen autorouter performance.

Therefore, if you decide to change cost factors, adjust no more than *two* cost factor variables at a time and make your changes in small increments. Large adjustments to many variables will almost certainly cause poor results. Also remember that many variables share strong mutual dependencies. For example, any increase in via placing costs compromises the router’s ability to route using preferred directions.

Complete the following steps to set up cost factor parameters:

1. Select the **Cost Factors** tab in the **Routing Options** dialog box.
2. Edit one or more of the following fields in the **Routing and Optimization** area:
 - **Via Cost Factor**—A high via cost factor results in fewer vias than a low via cost factor, but also results in relatively complex circuit traces. A low via cost factor permits the router to place vias up to the maximum number you specify with the **Maximum Via Count per Trace** function.
 - **Maximum Via Count per Trace**—This is the maximum number of vias that the router can place between two connected pins.
 - **Counter Direction Cost Factor**—a high counter direction cost factor forces a strict adherence to the layer-specific preferred routing directions, while a low factor permits deviations from the preferred direction.
 - **Off-Grid Routing Cost Factor**—Is considered only when you activate the half-grid option. A high off-grid routing cost factor limits the use router's use of the sub-grid, while a low factor permits frequent use of the sub-grid.
 - **Trace Crossing Cost Factor**—Sets the trace transition cost factor, which the router and optimizer use to control cleanup pattern recognition during multi-net optimization. A high trace crossing cost factor permits complex routing with many traces crossing each other. This creates a relatively large number of vias. A low factor leads to more intensive and time-consuming analysis during cross-net optimization. Relatively few vias are produced.
 - **Adjusted Width Cost Factor**—When **Auto Adjust Width** is selected in the **General** tab, a high adjusted width cost factor limits the router's use of narrow trace widths.
3. Edit one or more of the following fields in the **Routing** area:
 - **Pin Channel Cost Factor**—A high pin channel cost factor results in infrequent use of pin channels, the regions between adjacent part pins. A low value allows frequent use of pin channels.
 - **Packing Cost Factor**—A high packing cost factor instructs the router to bundle circuit traces wherever possible. A low factor results in a wider distribution of circuit traces across the board.
 - **Dynamic Density Cost Factor**—Controls the global distribution of traces. A high dynamic density cost factor explicitly tries to create an even or wide distribution of traces across the board, rather than letting the other costs determine how traces should be placed. A low factor lets trace distribution be determined by routing cost.

4. Edit one or both of the following fields in the **Optimization** area:
 - **Change Direction Cost Factor**—A high direction cost factor limits the number of trace corners the optimizer creates. A low factor allows frequent changes in routing direction.
 - **Equi-Space Trace Cost Factor**—A high value here indicates that traces will be spread out more during optimization, with a resultingly higher cost.
5. If you wish to return the values to the default settings for Ultiboard, click **Default**.



Caution The **Default** button sets default values for all tabs in the **Routing Options** dialog box.

Routing Options: Rip-Up Tab

Complete the following steps to set up rip-up parameters:

1. Select the **Rip-Up** tab in the **Routing Options** dialog box.
2. Edit one or more of the fields in the **Rip-up Trees** area:
 - **Maximum Rip-Up Trees**—Sets the maximum number of traces that can be ripped up during each rip-up cycle.
 - **Maximum Rip-Up Depth**—Controls the persistence of the rip-up process. The higher the value you set, the greater the persistence each rip-up cycle has (that is, the more ways the placement is analyzed before a final placement is made).
 - **Maximum Rip-Up Retries**—Sets the maximum number of rip-up retries for each trace. The higher the number of retries you set, the greater the rip-up intensity in each trace.



Note In general, high rip-up control values increase the persistence and intensity of the rip-up and routing process. Thus, high values are especially useful for special tasks, such as achieving 100 percent completion without intermediate router passes.

- **Distance-1 (0 or 1 Grid) Cost Factor**—Controls the use of channels left by ripped-up traces in the near distance (0-1 grid point, trace-to-trace). A high value results in infrequent use of these channels, forcing relatively more local changes during rip-up and retry routing. A low factor permits the router to use these channels freely.

- **Distance-2 (2 Grid) Cost Factor**—Controls the use of channels left by ripped-up traces in the far distance (2 or more grid points, trace-to-trace). A high value results in infrequent use of these channels, forcing relatively more global changes during rip-up and retry routing.
3. Optionally, enable the **Memory Cleanup During Routing** checkbox in the **Router Housekeeping** area to purge the memory of unneeded information.
 4. If you wish to return the values to the default settings for Ultiboard, click **Default**.



Caution The **Default** button sets default values for all tabs in the **Routing Options** dialog box.

Routing Options: Optimization Tab

Complete the following steps to set optimizer options:

1. Select the **Optimization** tab in the **Routing Options** dialog box.
2. Edit one or both of the fields in the **Optimizer** area:
 - **Optimizer Passes**—Use to set the number of optimizer passes that are automatically activated after the autorouter achieves 100 percent completion.
 - **Optimization Direction**—Select **Normal** to instruct the optimizer to ignore layer-specific preferred routing directions to keep the number of vias to a minimum; **Preferred Direction** to instruct the optimizer to consider layer-specific preferred routing directions. This may increase the number of vias on your board; **45 Degrees** to instruct the optimizer to prefer 45 degree routing where appropriate.
3. Optionally, enable the **Memory Cleanup During Optimizing** checkbox in the **Optimizer Housekeeping** area to purge the memory of unneeded information.
4. If you wish to return the values to the default settings for Ultiboard, click **Default**.



Caution The **Default** button sets default values for all tabs in the **Routing Options** dialog box.

Routing Options: Bus Autorouting Tab

To autoroute buses, the topology for the nets, as set in the **Net edit** dialog box, or the **Spreadsheet View**, must be set to either **Daisy chain** or **Star** and the nets must be part of a **Bus Group** as set in the **Edit Groups** dialog box. You can also add new **Bus Groups** from the **Bus Autorouting** tab in the **Routing Options** dialog box.

Complete the following steps to set Ultiboard bus routing options:

1. Select the **Bus autorouting** tab in the **Routing Options** dialog box.
2. Select the desired buses to route in the **Defined bus groups** area. Click **Select All** to select all available buses for routing or **Clear All** if you wish to clear all of the checkboxes in the **Defined bus groups** area.
3. If you wish to add or delete bus groups, or change a bus group's **Assigned Nets**, click **Edit**. The **Bus Groups** tab of the **Edit Groups** dialog box appears where you can **Add** or **Delete** bus groups. You can also change the nets assigned to a specific bus group from here by selecting or de-selecting the group's checkbox in the **Assign Nets** list.
4. When you start autorouting, the buses are routed as in the following example.

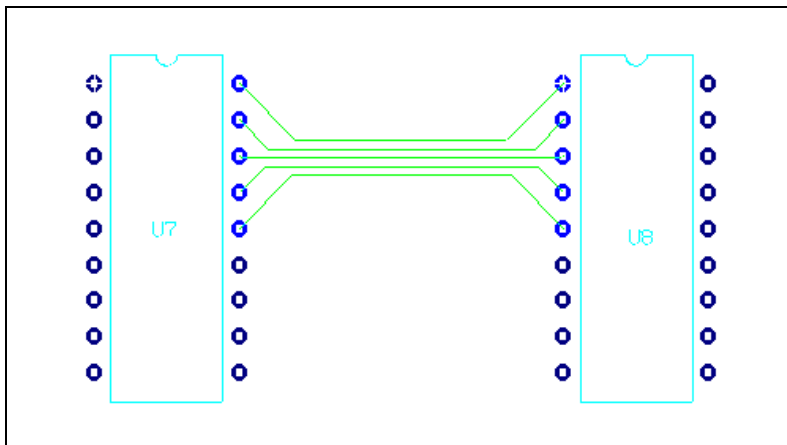

5. If you wish to return the values to the default settings for Ultiboard, click **Default**.



Caution The **Default** button sets default values for all tabs in the **Routing Options** dialog box.

Strategies to Achieve Better Routing Results

Speed and completion may be trade-offs. Many of the suggestions for routing completion will greatly increase the time needed to complete routing. While it may be tempting to try to guarantee completion by using all possible completion tricks for all layouts, many non-dense boards can be completely routed without them, and they will be routed much faster.

Set alternating layer biases. By default, each new Ultiboard project will have trace biases that alternate between horizontal and vertical with each successive layer. This setting greatly increases routing speed and completion rates and should not normally be changed. The exception is if you have placed several powerplanes. Because the router does not route traces on powerplane layers, these layer biases may need to be adjusted to preserve this alternating pattern so that it skips over those powerplane layers.

Try gridless routing. The default setting for routing is grid-based, which is the fastest routing algorithm. If this fails to achieve completion, then next step should almost always be to try gridless routing.

Make sure there is no via grid. The via grid increases routing speed by limiting the costly via placement calculations, but it can decrease routing completion since vias may not be placed in crowded areas of the board.

Try auto adjust trace width. If your design permits, set a smaller minimum width for some nets and turn on the “Auto Adjust Trace Width” feature.

Check your minimum/maximum lengths. Sometimes traces may not be routed because the pins are too far away to be routed with your specified maximum length, or too close together to be routed with your specified minimum length (the router can only increase the length of a trace by about sixty percent over optimum). Similar routing failures may occur with differential pairs when one leg of the pair is much longer than the other. In these cases, you should either change your minimum or maximum length settings, or route these problematic connections with Ultiboard’s follow-me router to achieve the desired length.

Preparing for Manufacturing/Assembly

The following sections explain the basic functions you need to perform to prepare your board for manufacturing.

Some of the described features may not be available in your edition of Ultiboard. Refer to the NI Circuit Design Suite Release Notes for a list of the features in your edition.

Placing and Editing Text

Text can be placed anywhere on the design and on any layer, regardless of what element is selected.



Complete the following steps to place text on the design:

1. Choose **Place»Graphic»Text**. The **Text** dialog box opens.
2. Type the text in the **Value** field. As you type, the text appears in the preview dialog box.
3. Define the following parameters for the text as desired:
 - **Line Font** radio button—Enable and select one of **Thin**, **Normal**, or **Bold**.
Or
 - **Windows Font** radio button—Enable if you wish to use a Windows font. Click the **Font** button and select the desired Windows font.



Note Ultiboard supports multi-byte fonts so that Chinese, Japanese, Korean and other users can make full use of Microsoft fonts for special characters.

- Select the desired **Height**, **Layer** and **Color**.
- In the **Alignment** box, select one of **Left**, **Center**, or **Right**; and one of **Top**, **Center**, or **Bottom**.

4. Optionally, in the **Next Label** area:
 - **Increment**—Enable to increase a number that you placed at the end of the text with each successive placement of that text. You must also enter a value in **Step Size**. For example, if you enable this checkbox and enter “1” in **Step Size**, and the **Value** you entered was “Resistor1”, the first placement of the text will say “Resistor1”, the second will say “Resistor2”, the third will say “Resistor3”, and so on.
 - **Decrement**—Similar to the **Increment** setting, except that the number will decrease by the **Step Size** with each successive placement. (The number will not go below 0).
5. Click **OK**. The **Text** dialog box disappears; the cursor now has your text on it.
6. Move the cursor where you want the text placed, and click to drop the text.
7. Right-click to cancel the **Place»Graphics»Text** command.

Complete the following steps to edit text:

1. Double-click the text. The **Copper Attribute Properties** dialog box opens.
2. Click on the **Attribute** tab.
3. Edit the text.
4. Click **OK**. The **Copper Attribute Properties** dialog box disappears and your changes are applied to the text in the design.

Capturing Screen Area

You can capture an area of the screen and then manipulate the image as you would any other screen capture contained in the system clipboard.

Complete the following steps to copy a section of your screen to the clipboard:



1. Select **Tools»Capture Screen Area**. A selection frame appears on your workspace.
2. Optionally, to move the frame to a different location:
 - Move your cursor to the border of the frame. A crosshair is added to the cursor, indicating that the selection frame can be moved to a different location.
 - Drag the selection frame to the desired location.

3. Optionally, to re-size the selection frame:
 - Move the cursor to one of the sizing handles.

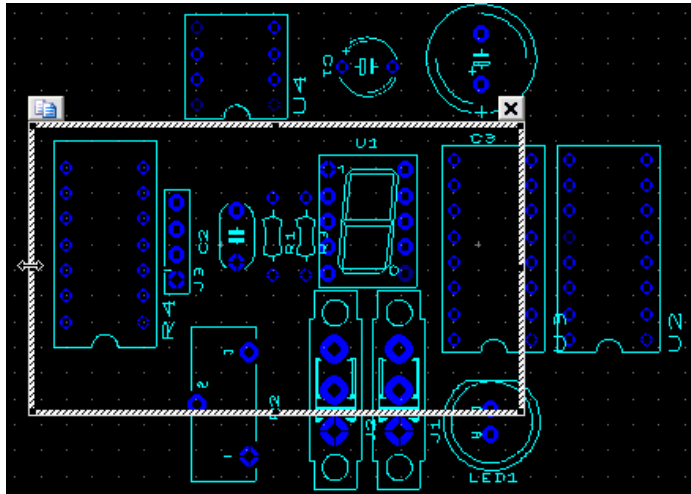

- Drag the cursor to re-size the selection frame.
4. Click on the **copy** button at the top left corner of the selection frame. The image inside the selection frame is copied to the system clipboard.
 5. Click on the **x** at the top right corner of the selection frame to close it.
 6. Open the desired application, for example, MS Word, and click on **Paste** to paste the image.



Placing a Comment

Adding a comment permits “redlining”, which can be used to show engineering change orders, to facilitate collaborative work among team members, or to allow background information to be attached to a design.

You can “pin” a comment to the workspace, or directly to a part. When a part with an attached comment is moved, the comment also moves. The figure below shows a comment pinned to a part with its contents displayed.

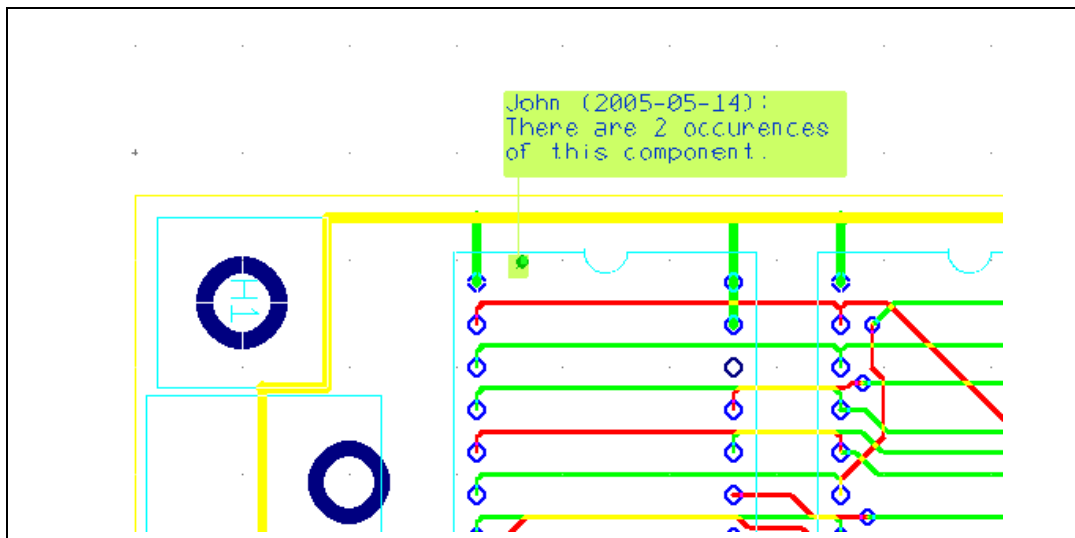

Complete the following steps to pin a comment to a part or the workspace:

1. Double-click on the **Comment** layer in the **Design Toolbox** to make it the active layer.
2. Select **Place»Comment**. The **Comment** dialog box appears.
3. If desired, enable the **Show Comment** checkbox to show the contents of the comment on the design.
4. Type the comment in the area below the **Show Comment** checkbox.
5. Optionally, modify the information in the **Color** box:

- **Background**—Click to change the color of the placed comment's background.
- **Text**—Click to change the color of the placed comment's text.

When you click either **Background** or **Text**, the **Select color** dialog box displays.

Enable the **Use named color** checkbox and select an element from the **Name** drop-down list.

Or

Disable the **Use named color** checkbox and select a color from the **Colors** palette.

Click **OK** to return to the **Comment** dialog box.

6. In the **Size** area:
 - **Auto-Resize** checkbox—Enable to have the size of the displayed comment automatically resized to fit the text. Disable if you wish to set the size of the displayed comment by typing values into the **Width and Height** fields.
7. In the **Font** area, set the font **Name**, **Style** and **Size** as desired.
8. Click **OK** to close the dialog and double-click at the desired location on the design to place the comment.

To change a placed comment's properties, select the comment (you must be in the **Comment** layer), and select **Edit»Properties**.

To delete a placed comment, select the comment and press **DELETE** on your keyboard.

Renumbering Parts

As parts are added to, moved, and deleted from the design, their numbering changes. Renumbering parts automatically renames all parts in the order that you specify. It is easier to produce, service, and troubleshoot boards when parts are ordered in a logical manner. Renumbering is primarily for assembly, to help locate all the elements.

Using the **Renumber parts** dialog box, you can select the corner of the board in which you want the renumbering to start, and whether you want the parts to be renumbered incrementally in a vertical or horizontal fashion. You can preview your renumbering strategy and change it before applying it.

Complete the following steps to renumber the parts in the design:

1. Optionally, select the parts you want renumbered.
2. Choose **Tools»Renumber Parts**. The **Renumber parts** dialog box appears.
3. Use the drop-down lists to select the **Direction** and **Start corner** for the renumbering and enter a value in **Part mask** if you want to renumber only certain parts. For example, you can put **R*** or **C*** in that box if you only want to renumber resistors or only capacitors; the default = * so everything gets renumbered.

The **Preview** panel illustrates the numbering's direction and start corner as you define the settings.



4. If you only want to renumber parts you selected prior to opening this dialog box, select the **Change selected parts only** option.
5. To apply your changes and keep the dialog box open, click **Apply**.
To apply your changes and close the dialog box, click **OK**.

Backannotation to Multisim

Backannotation is a highly automated process which ensures that modifications made to an Ultiboard design are transferred to the board's schematic in Multisim. This process helps keep your schematics and board layouts consistent with one another.

Backannotation is an important feature of CAD software. Part renaming or removing cause inconsistencies between the schematic and the PCB design. Backannotation can overcome these inconsistencies. To backannotate, Multisim reads the log file in which Ultiboard reports all the changes that are made to a PCB. The log file has the same name as the project, but with the extension `.log`.

Not all changes that are made to the PCB can be backannotated to Multisim. The following changes can be backannotated:

- part removing
- part renaming
- netlist renaming

Complete the following steps to backannotate your revisions:

1. Save and close your design in Ultiboard.
2. Open Multisim.
3. Follow the Back Annotation procedure documented in the *Multisim User Manual*.

Mitering Corners

Corner mitering is used to reduce or remove sharp angles for placed traces by creating 135° angles in their place. This is important for manufacturing purposes. You can apply corner mitering to the entire design or just the currently selected traces.

Complete the following steps to miter the corners of traces prior to manufacturing:



1. Optionally, select the traces to which you want mitering to apply.
2. Choose **Design»Corner Mitering**. The **Corner Mitering** dialog box appears.
3. To apply the changes to just the selected traces, enable the **Current Selection** option. To apply the changes to the whole design, enable the **Whole Design** option.
4. To set a minimum length for the mitering, enable the **Minimum Length** option and enter a length and units of measurement.

Any corner that is to be mitered will have two trace segments forming the corner. The **Minimum Length** refers to the shortest length of a segment that should be mitered. For example, assume a corner is formed from a 6 mm segment and an 8 mm segment. A minimum length setting greater than 2 mm will cause the trace to not be mitered.

The default is 0, that is, all traces will be mitered regardless of the minimum length of any one segment.

5. To set a maximum length for the mitering, enable the **Maximum Length** option and enter a length and units of measurement.

The **Maximum Length** setting refers to the maximum length of the mitered segment. The longest length of the mitered segment in the horizontal or vertical direction will not exceed the **Maximum Length** or one third of the shortest segment. Using the example of a corner formed from a 6 mm segment and an 8 mm segment, a **Maximum Length** setting of 3 mm will cause the trace to be mitered to 2 mm (that is, one third of 6 mm).

The default is 0, that is, all traces will be mitered regardless of the maximum length of any one segment.

6. To set the angle of corners to be affected by mitering, enable the **Angle Maximum** option and enter a value. For example, a setting of 95° will mean that all angles less than 95° will be mitered to 135°.
7. To have an arc placed when doing the mitering, enable the **Place Arcs** option.
8. To save your changes and miter the corners, click **OK**. To cancel them, click **Cancel**.

Manually Re-Running the Design Rules and Netlist Check

The design rules and netlist check normally runs automatically, but you may want to force a final check of the board's integrity prior to saving or exporting the design.

To do this, select **Design»Netlist and DRC Check**. The results of the check appear in the **Results** tab of the **Spreadsheet View**.

Cleaning up the Board

Before sending the board for manufacturing, you should remove any open trace ends and unused vias that have been left on the board.

Deleting Open Trace Ends

Open trace ends are trace segments that do not have any terminating connections in the design.



To delete open trace ends, make sure the design is open and choose **Edit»Copper Delete»Open Trace Ends**. This deletes all open trace ends in the design.

Deleting Unused Vias

Normally, you would delete unused vias after deleting any open trace ends.



To delete any unused vias, make sure the design is open and choose **Design»Clean Unused Vias** to delete all vias that do not have any trace segments or copper areas connected to them.

Exporting a File

Exporting a file refers to producing an output from Ultiboard in a format that can be understood by the equipment at the board manufacturer. An exported file contains complete information describing how a finished board is to be manufactured. There are many different manufacturing techniques used to produce printed circuit boards and Ultiboard can produce a wide variety of outputs to meet these needs.

It is important to talk to your production house and identify all the files and formatting information they need to support their manufacturing process.

You can export a file in the following formats:

- Gerber photoplotter 274X or 274D
- DXF
- 3D DXF (refer to the [Exporting to 3D DXF](#) section of Chapter 9, [Viewing Designs in 3D](#), for information)
- 3D IGES (refer to the [Exporting to 3D IGES](#) section of Chapter 9, [Viewing Designs in 3D](#), for information)
- IPC-D-356A Netlist (refer to the [Exporting the Desired File](#) section for information)
- NC drill
- SVG (Scalable Vector Graphics)

You can also export text files that contain:

- Board Statistics
- Part Centroids
- Bill of Materials

You can also create reports on:

- Copper Amounts
- Test Points
- Layer Stackup

Exporting a file begins by opening the **Export** dialog box. You can also use the **Export** dialog box to create and delete export settings, and to view and edit the properties of the export settings.

Using Export Settings

Export settings are useful for establishing different parameters as required by different manufacturers or for different purposes (for example, to export only copper layers, or mechanical drawings).

Complete the following steps to create a new export setting:

1. Choose **File»Export**. The **Export** dialog box appears.
2. Click **New**. The **New settings** dialog box appears.
3. Enter the new name and click **OK**. The **New settings** dialog box disappears and the new setting is displayed in the **Export settings** drop-down list.

The new setting uses the same properties as the **Default** setting, or the setting that was last loaded. Refer to the *Viewing and Editing Export Properties* section for information about changing the properties stored in the new setting.

Complete the following steps to delete an export setting:

1. Choose **File»Export**. The **Export** dialog box appears.
2. Select the setting to be deleted from the **Export settings** drop-down list.
3. Click **Delete**. The setting is deleted from the **Export settings** drop-down list.

Viewing and Editing Export Properties

Properties can be viewed and edited for each device or type of export. This is done through the property dialog boxes that correspond to the devices or types listed in the **Export** dialog box:

- Gerber RS-274D
- Gerber RS-274X
- DXF
- Board Statistics
- Bill of Materials
- Parts Centroids
- NC Drill

Complete the following steps to display the properties dialog box for a type of export:

1. Select the item in the list displayed in the **Export** dialog box.
2. Click **Properties**. The item's property dialog box appears.

Setting Gerber Properties

The **Gerber properties** (RS-274X or RS-274D) dialog box allows you to select the layers to be exported, the number of digits in numerals, and the kind of measurements:

- **Available layers** list—Select the layers to export in this list and click the -> button to move them to the **Export Layers** and **Merged Layers** list (RS-274X only).
- **Units** box—Select measurement system (**Imperial** or **Metric**).
- **Digits** box—Define the number of integers and decimal places.

- **Oversize** box—Define the parameters for solder mask and solder paste.
- **Options** box—Select the desired options.

Setting DXF Properties

The **DXF export settings** dialog box allows you to select the layers to be exported and the units of measurement to be used:

- **Available layers** list—Select the layers to export in this list and click the -> button to move them to the **Layers to process** list.
- **File Units** box—Choose the units of measurement.

Setting NC Drill Properties

The **Drill export properties** dialog box allows you to specify measurement units, and to specify the number of digits for integers and decimals:

Complete the following steps to change the NC drill properties:

1. Select **NC Drill** in the **Export** dialog box and click properties. The **Drill export properties** dialog box appears.
2. In the **Units** box, select either the **Imperial** or **Metric** radio button.
3. Enter the following in the **Digits** box as required:
 - **Integer**—The number of integers to the left of the decimal point.
 - **Decimal**—The number of decimal places.

This option aids the export of NC drill files for objects such as rectangle and squares which have no radius.
4. Click **OK** to accept the changes.



Note When a pad is used with an **Advanced Hole**, and only when a square or rectangle shape is used, export to NC Drill calculates the edge of the hole minus the radius of the minimum tool size for the slot drill. Refer to the [Viewing and Editing Through Hole Pin Properties](#) section for more information.

Working with SVG Properties

The **SVG Export Properties** dialog box allows you to specify whether Scaleable Vector Graphic (SVG) files will be compressed or not when they are exported. You can also select the minimum stroke width for exported objects like circles.

Complete the following steps to change the SVG export properties:

1. Select **Scalable Vector Graphics** in the **Export** dialog box and click **Properties**.
2. In the **SVG File Format** box, select one of:
 - **Compressed svg**—The SVG file will be compressed when it is exported.
 - **Uncompressed svg**—The SVG file will not be compressed when it is exported.
3. Enter the **Minimum stroke width** in the **SVG Options** box. This is the minimum width of an object's border, in micrometers.
4. Click **OK** to accept the changes.

Working with other Properties

Working with Board Statistics Properties

The **Board Statistics** dialog box allows you to view the statistics on the board being exported as well as to filter the file types to be exported and to define the units of measurement in the statistics:

- **Statistics list**—The list at the top of the dialog displays the board statistics, including DRC violations.
- **File type** box—Select any of **TXT**, **CSV**, and **HTML**.
- **Units** box—Select the unit of measurement.

Working with Bill of Materials Properties

The **Bill of Materials** dialog box displays the bill of materials, and includes facilities for sorting the information displayed:

- **Columns**—Click column headers in the bill of materials list to sort the columns.
- **File type** box—Select any of **TXT**, **CSV**, and **HTML**.
- **Add column** button—Other attributes that have been defined for objects can be assigned to columns for reporting purposes (for example, preferred part supplier). Click to define a new column.
- **Remove column** button—Select a column to remove in the drop-down list and click this button.

Working with Parts Centroids Properties

The **Parts Centroids** dialog box provides a list of all parts on the boards and their coordinates, and includes facilities for sorting the information displayed:

- **Columns**—Click column headers in the list to sort the columns.
- **File type** box—Select any of **TXT**, **CSV**, and **HTML**.
- **Units** box—Select the unit of measurement.
- **Add column** button—Other attributes that have been defined for objects can be assigned to columns for reporting purposes (for example, preferred part supplier). Click to define a new column.
- **Remove column** button—Select a column to remove in the drop-down list and click this button.

Working with Test Point Properties

The **Test Points Report** dialog box provides a list of all test points on the boards and their coordinates:

- **Columns**—Click column headers in the list to sort the columns.
- **File type** box—Select any of **TXT**, **CSV**, and **HTML**.
- **Units** box—Select the unit of measurement.
- **Add column** button—Other attributes that have been defined for objects can be assigned to columns for reporting purposes (for example, preferred part supplier). Click to define a new column.
- **Remove column** button—Select a column to remove in the drop-down list and click this button.

Working with Copper Amount Properties

The **Copper Amounts Report** dialog shows the amount of copper used on the board:

- **Columns**—Click column headers in the list to sort the columns.
- **File type** box—Select any of **TXT**, **CSV**, and **HTML**.
- **Units** box—Select the unit of measurement.
- **Add column** button—Other attributes that have been defined for objects can be assigned to columns for reporting purposes (for example, preferred part supplier). Click to define a new column.
- **Remove column** button—Select a column to remove in the drop-down list and click this button.

Working with Layer Stackup Properties

A **Layer Stackup Report** shows you a board's layers, the layer type (ground, power, signal or unassigned) and the types of vias that are between layers. The **Layer Stackup Report** dialog lets you set which file types to export when you run a **Layer Stackup Report**.

Exporting the Desired File

Complete the following steps to export a file:

1. Select **File»Export** to display the **Export** dialog box.
2. Select the export setting to be used.
3. If desired, change any properties stored in the export setting.



Note When exporting an IPC-D-356A netlist, there are no user-settable properties.

4. Select the type of export from the list.
5. Click **Export**. A dialog box opens where you can define the export file's name and path. If you are exporting more than one file, you must define the name and path of each file.
6. Select the path that defines the export file's location and type the file's name.
7. Click **Save**. The file has been exported.

Printing your Design



Complete the following steps to print a design file:

1. Choose **File»Print**. The **Print** dialog box appears.
2. Choose from the list of available printers and, if necessary, set the printer's properties appropriately.
3. To print a negative image, enable the **Print Negative Image** option.
4. To print the reflection (mirror image), enable the **Print Reflection** option.
5. To leave drill holes open, enable the **Leave Drill Holes Open** option.
6. Select the layers you want to print in the **Available layers** list and click the arrow to move them to the **Layers to print** list.
7. For each layer you choose to print, you can enable or disable the **Outline** option to specify whether or not to include the board outline with the layer.

Once you have more than one layer selected, you can choose to print layers on separate sheets. You can also choose to print a header at the top of each page, containing the design name, date, and layer name. Finally, you can use the arrows to change the order in which layers will be printed.

8. When you have finished setting the print parameters, click **Print**.

Complete the following steps to print a 3D image of your design:

1. Select **Tools»View 3D**. The 3D view of the design appears.
2. Scale the image to the desired size and orientation. For details, refer to the [Viewing Designs in 3D](#) section of Chapter 9, [Viewing Designs in 3D](#).
3. To set up the printing of the 3D image, select **File»Print Setup**.
4. To preview the printing of the 3D image, select **File»Print Preview**.
5. Select **File»Print** and click **OK**.

Previewing the Printed Design

Complete the following steps to preview the way a design will look when printed:



1. Choose **File»Print**. The **Print** dialog box appears.
2. Click **Preview**. (At least one layer must be in the **Layers to print** column to enable the **Preview** button). The **Preview** screen appears, displaying an image of what the printed file will look like.



Tip A blank page in a preview dialog box usually indicates an empty layer is being previewed. If the preview displays a blank page, go back and make sure that you are previewing a layer that has something on it.

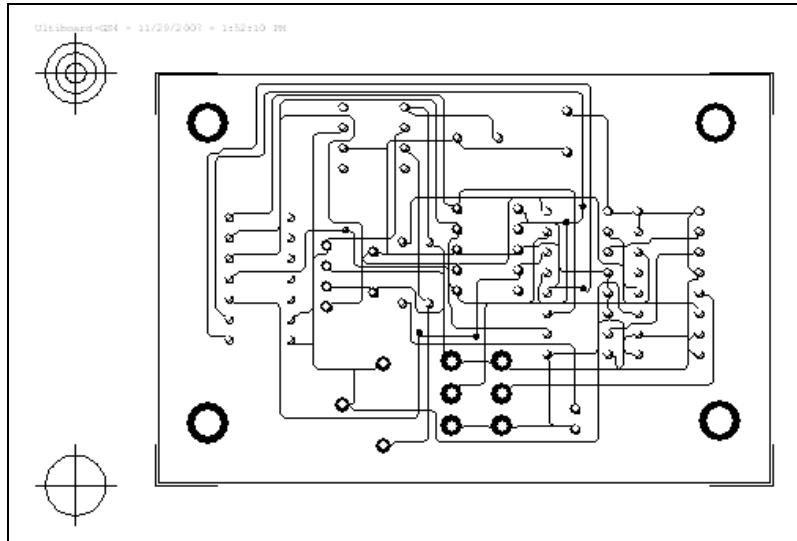

If you elect to enlarge the size of your printout in the **Zoom Options** area, each layer will be tiled onto as many pages as required to print the whole layer.

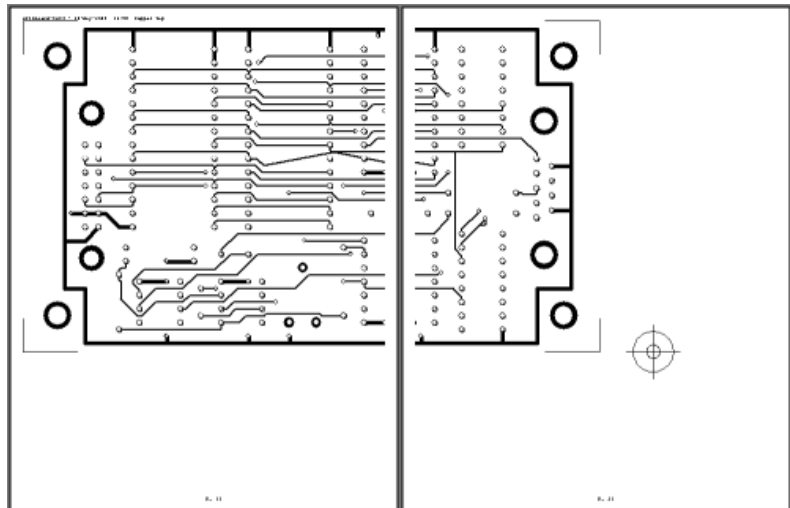

Viewing Designs in 3D

Ultiboard allows you to see what the board looks like in three dimensions (3D) at any time during the design.

The following sections explain how to set up the options for 3D viewing, how to view the board in 3D, and how to manipulate the view.

Some of the described features may not be available in your edition of Ultiboard. Refer to the NI Circuit Design Suite Release Notes for a list of the features in your edition.

Viewing the Board in 3D



To view the board in three dimensions, choose **Tools»View 3D**.

A new window opens displaying a 3D representation of the board:

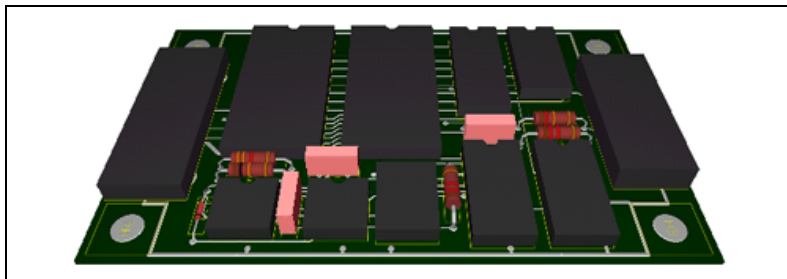

The **Projects** tab in the **Design Toolbox** indicates that you have a 3D view open, in addition to the design from which the 3D view was taken.

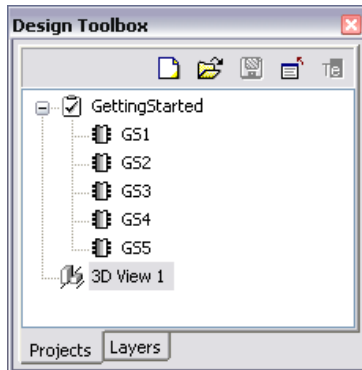

To close the 3D view, right-click on the 3D view in the **Projects** tab and choose **Close Window** from the context menu.



Note If you loaded a file from Ultiboard 2001, before you can use the 3D view you must use **Tools»Update Shapes**. The 3D appearance of individual parts is controlled by the 3D properties of those parts. Refer to the *Viewing and Editing Part Properties* section of Chapter 4, *Working with Parts*, for more information.

Manipulating the 3D View

When you choose **Tools»View 3D**, the view appears so that you are looking at a three dimensional rendition of the top of the board on an angle. You can manipulate this view to show you all points on the board, top and bottom, at any angle you choose.

You manipulate the 3D view with the mouse pointer, which represents your viewing position and the light source that illuminates the part. You can click and drag the mouse to rotate the board, and you can change the angle at which it displays, allowing you to flip it over to see the bottom. The view rotates around the center of the board. When you let go of the mouse button, the board stays in its most recent view.

Complete the following steps to manipulate the 3D view:

1. Select **Tools»View 3D Position**.
2. Click and hold the mouse button down on the board in the 3D view.

3. Continue holding the button and move the pointer as follows:
 - to the bottom of the screen to view more of the top of the board.
 - to the top of the screen to view the edge and then the underside of the board.
 - to the left or right to view the board from either end.

Complete the following steps to pan the 3D view:

1. Hold down your mouse wheel. The pointer becomes a four-headed arrow.
2. Move the pointer in any direction.

Complete the following steps to turn the board over:

1. Click and hold on the board.
2. Move the pointer up, towards the top of the screen. As the view of the edge passes, release the mouse button and catch the underside of the board.
3. Continue until you can see the underside of the board fully.

To zoom in a 3D design do one of the following:

- Click and hold the right mouse button. Roll the mouse up to zoom in and down to zoom out.
- Or*
- Use **View»Zoom In** and **View»Zoom Out**. You can also use your mouse wheel, if available.

Controlling the Elements Viewed in 3D

The **Design Toolbox** in the 3D view also has a **Layers** tab. The layers on this tab do not necessarily correspond to the layers in the design, but they work the same way as the **Layers** tab does in designing: the 3D **Layers** tab allows you to dim or remove elements from the board. Refer to the [Accessing Layers](#) section of Chapter 3, [Setting Up a Design](#), for more information.

A typical 3D **Layers** tab has a **Parts, Silkscreen, Copper, Board** and **Pins** layer.

Showing an Object's Height

While in the 3D view, you can show an object's height, as shown in the figure below.

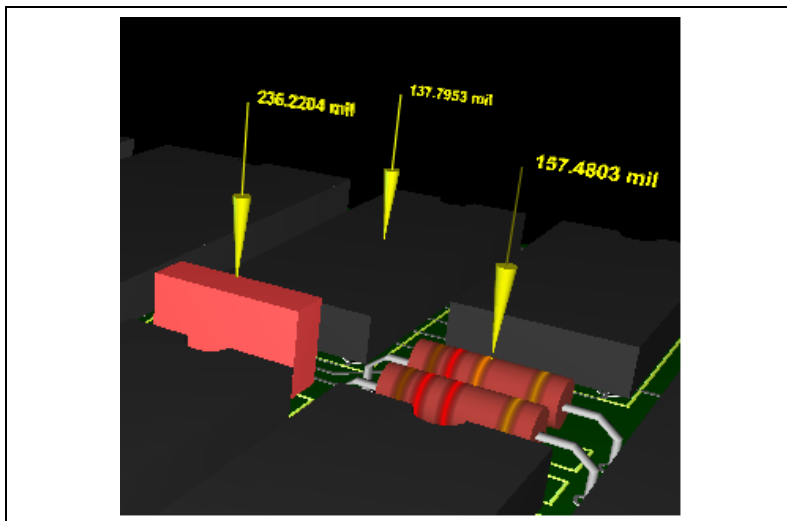

Complete the following steps to show an object's height:

1. Select **Tools»Show or Hide Height**.
2. Click the cursor on a 3D part. A callout with the part's height appears.
3. Repeat on as many parts as desired.

To hide a part's height, click on the part. The callout with the height disappears.

To rotate or magnify the board, select **Tools»View 3D Position**. Refer to the [Manipulating the 3D View](#) section for more information about this command.

Internal View

You can use the **Internal View** to look between the layers of a multi-layer PCB.

Complete the following steps to view the 3D internal view of a PCB:

1. From the 3D view, select **View»Internal Layers**.
2. Zoom in and out on the **Internal View** as desired.

The figure below shows the normal 3D view of a sample PCB.

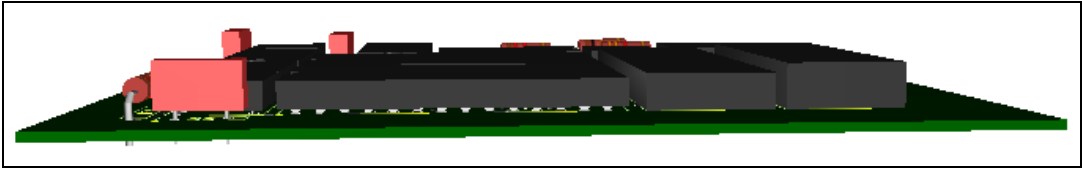

The figure below shows the internal 3D view of the same PCB.

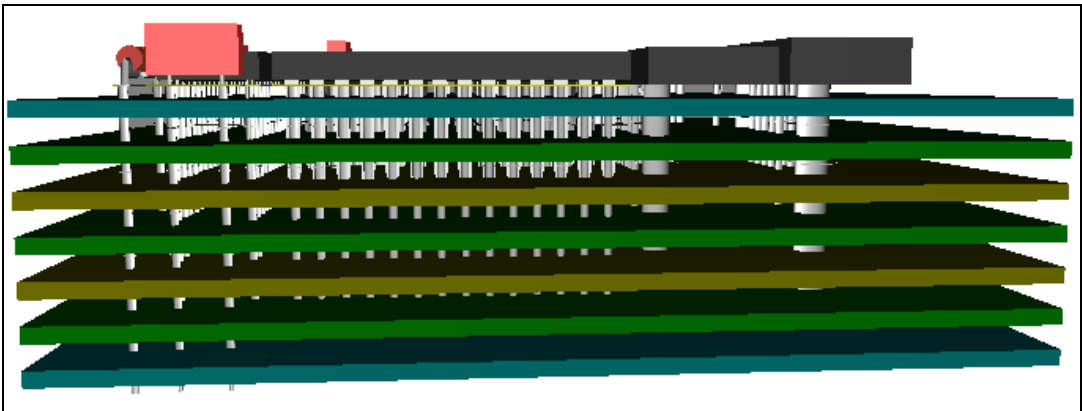

Note Internal View options are set in the **3D Options** tab of the **Preferences** dialog box. Refer to the *3D Options Tab* section of Chapter 1, *User Interface*, for more information.

Exporting to 3D DXF

Ultiboard can export a 3D DXF file for your design.

Complete the following steps to export a design's 3D properties:

1. Select **File»Export** to display the **Export** dialog box.
2. Highlight **3D DXF** and click **Properties**. The **DXF export settings** dialog box appears.
3. Select the desired parameters to export and click **OK**. You are returned to the **Export** dialog box.
4. Click **Export**. A standard Windows Save dialog appears.
5. Select the desired filepath and enter the 3D DXF filename (the file extension must be **.DXF**).
6. Click **Save**.

Exporting to 3D IGES

3D IGES (Initial Graphics Exchange Specification) is a file format for the exchange of CAD information (both 2D and 3D). A 3D IGES file contains surface information and details of a part.

Complete the following steps to export a design's 3D IGES properties:

1. Select **File»Export** to display the **Export** dialog box.
2. Highlight **3D IGES** and click **Properties**. The **IGES export settings** dialog box appears.
3. Select the desired parameters to export and click **OK**. You are returned to the **Export** dialog box.
4. Click **Export**. A standard Windows Save dialog appears.
5. Selected the desired filepath and enter the 3D IGES filename (the file extension must be `.iges`).
6. Click **Save**.

Using Mechanical CAD

Ultiboard's mechanical CAD function can be used to design enclosure boxes, front panels, or any other mechanical part associated with your PCB design. Mechanical CAD functionality in Ultiboard takes two forms:

- You can create multi-layer mechanical CAD design files.
- You can have mechanical CAD layers as part of your PCB design files. Design files can include up to 10 mechanical CAD layers. These are accessed through the **Layers** tab of the **Design Toolbox** and can be used in the same way as other layers in your design. Refer to the [Accessing Layers](#) section of Chapter 3, [Setting Up a Design](#), for more information.

For the most part, you work with mechanical CAD designs the same way that you do with PCB designs, although you cannot place traces or use the Autoroute function in mechanical CAD designs.

Some of the described features may not be available in your edition of Ultiboard. Refer to the *NI Circuit Design Suite Release Notes* for a list of the features in your edition.

Creating Mechanical CAD Projects



To create a new project :

1. Choose **File»New Project**. The **New Project** dialog box appears.
2. Type the project name in the **Project name** field.
3. From the **Design type** drop-down list, select **Mechanical CAD**.
4. Indicate the folder where the file is to be kept. Either accept the default shown in the **Location** field, or click the Browse button to select a different location.
5. Click **OK**. The **New Project** dialog box disappears, and a blank unnamed mechanical CAD design is opened in that project. The project you just created is also shown in the **Projects** tab.

Creating Mechanical CAD Design Files

To create a new mechanical CAD design, you can either use the new design that appears when you create a mechanical CAD file, or you can create a new design and assign it to an existing file. To create a new design and assign it to an existing file:



1. Open the file that the new design is to be added to.
2. Choose **File»New Design**. The **New Design** dialog box appears.
3. Type the design name in the **Design name** field.
4. From the **Design type** drop-down list, select **Mechanical CAD**.
5. Indicate the file where the design is to added. The drop-down list shows only the open files. To include this design in another project, open the file so that it appears in the **Add to project** drop-down list.
6. Click **OK**. The **New Design** dialog box disappears, and a blank mechanical CAD design with the name that you specified is opened as a separate window.

The **Projects** tab shows the mechanical CAD design is a part of the open project that you specified during the design's creation the dialog box. In the example shown below, "test" is the mechanical CAD design.

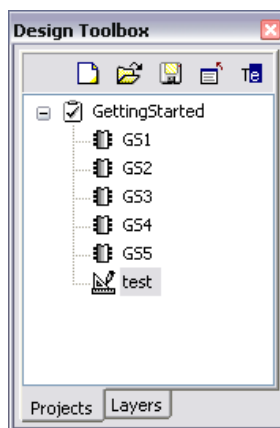

Note Mechanical CAD designs can be part of a project containing PCB designs. Project files are independent of design file types.

Importing a DXF File

Complete the following steps to import a DXF file into a mechanical CAD design:

1. Choose **File»Import»DXF**. A standard file selector appears.
2. Navigate to the correct location for the .dxf file, select it and click **OK**.

Setting Mechanical CAD Properties and Options

Setting Mechanical CAD Properties

To set mechanical CAD properties:



Choose **Edit»Properties**.

Or

Right-click on an empty area of the design and choose **Properties** from the context menu.

Working with mechanical CAD properties is done the same way as with PCB properties, except that mechanical CAD designs have only two grids.

Setting Mechanical CAD Colors



1. Choose **Options»Global Preferences**. The **Preferences** dialog box appears.
2. Click the **Colors** tab.
3. Adjust the following as required:
 - **Color scheme** drop-down list—Select the desired color scheme.
 - **Color element** drop-down list—Select the element from the drop-down list. Click the colored button beside this field to display a color palette. Optionally, click **New element** to define a new element for the **Color element** list.
 - **Grayed out factor** slider bar—Move the slider to adjust the appearance of grayed-out items on the design.

Except for default elements being slightly different, this dialog box works the same way as for PCB designs. Refer to the *Colors Tab* section of Chapter 1, *User Interface*, for more information.

Controlling Workspace Elements for Mechanical CAD

The **General** tab allows you to control whether or not invisible attributes or cross hairs are shown in normal view, and options for full screen view. This tab also allows you to have Ultiboard load your last project automatically, and to have Ultiboard automatically save your project at specified intervals.

Complete the following steps to view or change workspace options:



1. Choose **Options»Global Preferences**. The **Preferences** dialog box appears.
2. Click the **General** tab.
3. Adjust the **View** box settings as desired:
 - **Show invisible attributes**—These are set up in the **Attributes** tab (**Visibility** column) of the element's properties dialog.
 - **Show crosshair**—Displays a large crosshair that is attached to your mouse's pointer.
4. Adjust the **Crosshair** box settings as desired:
 - **Keep always on grid**—Makes sure that the crosshair will always snap to grid points even when you are not placing any parts or traces (normally when you are not placing parts or traces the crosshair moves gridless).
 - **Drop on left mouse button**—Changes the way moving of objects works. Normally when you start a move, the object will be dropped when you release the left mouse button. When this option is enabled, releasing the mouse button will not drop the part - only pressing the left mouse button will.
5. Adjust the **Fullscreen mode** box settings as desired:
 - **Show scrollbars**—Places vertical and horizontal scrollbars in the fullscreen view. Use these to move to the desired area on the workspace.
 - **Autopan**—Automatically moves the view of the workspace as you move the cursor offscreen.
6. Increase or decrease the **Undo buffer size** as desired. The number here is the number of undo actions allowed.
7. In the **File** box, enable **Load last file on startup** if you would like to continue working on the last file you had open in your previous Ultiboard session.
8. Select the desired settings in the **Mouse Wheel Behavior** box.

9. In the **Auto save settings** box:
 - **Enable auto save**—Activates the autosave function. When activated, you can also change the time between autosaves in the **Time interval (minutes)** field.
10. Edit the following as desired:
 - **Minimum control point size**—The size of control points on vertices and other objects.
 - **Line width cache size**—The number of recently used line widths Ultiboard keeps in memory. Minimum cache size is 5.
 - **Unicode Settings** box—If desired, enable the **Save .TXT files as plain text** checkbox.
 - **Language**—Select the desired language from the list. You must restart Ultiboard for all dialog boxes to reflect the new setting.

Setting Paths for Mechanical CAD

The Ultiboard installation puts specific files in specific locations. If necessary you can point Ultiboard to a new location.

Complete the following steps to set up file locations for mechanical CAD files:



1. Choose **Options»Global Preferences**. The **Preferences** dialog box appears.
2. From the **Preferences** dialog box, click the **Paths** tab.

This tab works the same way as the one for PCB designs. Refer to the [Paths Tab](#) section of Chapter 1, [User Interface](#), for more information.

Setting Mechanical CAD Dimensions



Complete the following steps to set mechanical CAD dimensions:

1. Choose **Options»Global Preferences**. The **Preferences** dialog box appears.
2. Click the **Dimensions** tab and set the parameters for dimensions.

This tab works the same way as the **Dimensions** tab for PCB designs. Refer to the [Dimensions Tab](#) section of Chapter 1, [User Interface](#), for more information.

Menus and Commands

The following sections contain brief descriptions for the commands in the Ultiboard menus.

Some of the described menu items may not be available in your edition of Ultiboard. Refer to the NI Circuit Design Suite Release Notes for a list of the features in your edition.

File Menu

The subjects in this section describe the commands found in the **File** menu.

File»New Design

Creates a new design (if a project is open) or project (if no project is open). Refer to the *About Designs and Projects* section of Chapter 2, *Beginning a Design*, for more information.

File»New Project

Creates a new project. Refer to the *About Designs and Projects* section of Chapter 2, *Beginning a Design*, for more information.

File»Open

Opens an existing project and/or design file. Refer to the *Opening an Existing File* section of Chapter 2, *Beginning a Design*, for more information.

File»Open Samples

Displays the `samples` folder.

File»Save

Saves the current design file and project.

File»Save As

Saves the current design file with a name and location that you specify in the **Save As** dialog box.

File»Save All

Saves all open design files and projects.

File»Close

Closes the current design file.

File»Close Project

Closes the current project.

File»Close All

Closes all open design files and projects.

File»Import

Use to import an Ultiboard Netlist or DXF file. Refer to the [Creating a Design from a Netlist File](#) section of Chapter 2, [Beginning a Design](#), and the [Importing a DXF File](#) section of Chapter 3, [Setting Up a Design](#), for more information.

File»Export

Exports Ultiboard files for post-processing. Refer to the [Exporting a File](#) section of Chapter 8, [Preparing for Manufacturing/Assembly](#), for more information.

File»Save Technology

Lets you save a technology file based on the current design that contains the design rules and configuration options for Ultiboard. Refer to the [Saving Technology Specifications from a Design](#) section of Chapter 2, [Beginning a Design](#), for more information.

File»Load Technology

Lets you load a technology file that contains the design rules and configuration options for Ultiboard. Refer to the [Loading Technology Files](#) section of Chapter 2, [Beginning a Design](#), for more information.

File»Print Setup

Sets up the printing parameters required to print the Ultiboard design file. Refer to the *Printing your Design* section of Chapter 8, *Preparing for Manufacturing/Assembly*, for more information. This is found in the **3D view** only.

File»Print Preview

Lets you preview the design file before printing. Refer to the *Printing your Design* section of Chapter 8, *Preparing for Manufacturing/Assembly*, for more information. This is found in the **3D view** only.

File»Print

Prints the Ultiboard design file. Refer to the *Printing your Design* section of Chapter 8, *Preparing for Manufacturing/Assembly*, for more information.

File»Recent Designs

Displays a list of the most-recently-opened projects. Click on the desired item in the list to open it.

File»Exit

Exits Ultiboard. You are prompted to save any unsaved design files and/or projects.

Edit Menu

The subjects in this section describe the commands found in the **Edit** menu.

Edit»Undo

Undoes your most recent action (for example, undoes the last part move). The command name changes to reflect what will be undone.

Edit»Redo

Redoes your most recent “undo” action. The command name changes to reflect what will be redone.

Edit»Cut

Removes the selected element(s) from the board. The element is placed on the Windows Clipboard and can be pasted again.

Edit»Copy

Copies the selected elements and stores them on the Windows Clipboard so they can be pasted again.

Edit»Paste

Pastes the item on the Windows Clipboard to its original layer (regardless of what layer is currently active). Creates new duplicate object(s) without the netlist information. New parts will have Reference Designators that increment from the next available for that part type. For example, if the last resistor was R34, and a resistor is pasted, its Reference Designator will be R35.

Edit»Paste Special

- **Paste with Net**—Pastes the item on the Windows Clipboard into the design with the same connectivity as the source. New parts will have Reference Designators that increment from the next available for that part type.
- **Paste to Active Layer**—Pastes the item on the Windows Clipboard to the active layer (regardless of what layer it originally resided on).

Edit»Delete

Use to delete the selected design elements. You are prompted to confirm the deletion.

Edit»Copper Delete

Deletes open trace ends, unused vias, or all copper elements:

- **All Copper**—Use to delete all copper in the design, including traces, copper areas, and powerplanes. Refer to the [Deleting All Copper](#) section for more information.
- **All Teardrops**—Use to delete all teardrops on your design. Refer to the [Adding and Removing Teardrops](#) section of Chapter 5, [Working with Traces and Copper](#), for more information.

- **Open Trace Ends**—Use to delete all open trace ends in the design. Use to clean up the design after design completion. Refer to the *Deleting Open Trace Ends* section of Chapter 8, *Preparing for Manufacturing/Assembly*, for more information.
- **Copper Island**—Use to remove copper islands. Refer to the *Placing Copper Areas* section of Chapter 5, *Working with Traces and Copper*, for more information.

Edit»Find

Use to find an element in the design. Refer to the *Searching for Design Elements* section of Chapter 2, *Beginning a Design*, for more information.

Edit»Select All

Use to select everything on a board, no matter what layer the elements are on. Refer to the *Searching for Design Elements* section of Chapter 2, *Beginning a Design*, for more information.

Edit»Select Entire Trace

Use to select a whole trace when one or more segments of the same trace are selected.

Edit»Group Selection

Groups selected elements together. Grouped elements can be moved together.

Edit»Ungroup Selection

Ungroups the individual elements in a group.

Edit»Lock

Locks the selected elements in place so they cannot be moved.

Edit»Unlock

Unlocks the selected elements.

Edit»Selection Filter

Use these commands to prevent accidentally selecting a particular type of element, for example, selecting a part when you meant to select a trace:

- **Enable Selecting Parts**—When enabled, allows parts to be selected.
- **Enable Selecting Traces**—When enabled, allows traces to be selected.
- **Enable Selecting Polygons**—When enabled, allows polygons to be selected.
- **Enable Selecting Vias**—When enabled, allows vias to be selected.
- **Enable Selecting Pads**—When enabled, allows pads to be selected.
- **Enable Selecting SMD Pads**—When enabled, allows surface mount device pads to be selected.
- **Enable Selecting Attributes**—When enabled, allows attributes to be selected.
- **Enable Selecting Other Objects**—When enabled, allows other objects on the PCB to be selected.

Edit»Orientation

Use these commands to adjust the orientation of parts as they are placed on a design:

- **Flip Horizontal**—Flips the selected elements horizontally.
- **Flip Vertical**—Flips the selected elements vertically.
- **90 Clockwise**—Flips the selected elements 90 degrees clockwise.
- **90 CounterCW**—Flips the selected elements 90 degrees counter-clockwise.
- **Angle**—Allows you to specify the angle of rotation for the selected elements.
- **Swap Layer**—Swaps the selected elements from a layer to its mirror layer (for example, from **Copper Top** to **Copper Bottom**).

Refer to the *[Orienting Parts](#)* section of Chapter 4, *[Working with Parts](#)*, for more information.

Edit»Align

Use these commands to align the edges of the elements:

- **Align Left**—Aligns the left edges of the selected elements.
- **Align Right**—Aligns the right edges of the selected elements.

- **Align Top**—Aligns the top edges of the selected elements.
- **Align Bottom**—Aligns the bottom edges of the selected elements.
- **Align Center Horizontal**—Shifts the selected elements horizontally so their centers are aligned.
- **Align Center Vertical**—Shifts the selected elements vertically so their centers are aligned.
- **Align to Coordinate**—Displays the **Enter coordinate** dialog box where you enter new coordinates for the selected element.
- **Space Across**—Spaces three or more objects beside each other evenly.
- **Space Across Plus**—Increases horizontal space between two or more objects.
- **Space Across Min**—Decreases horizontal space between two or more objects.
- **Space Down**—Spaces three or more objects above each other evenly.
- **Space Down Plus**—Increases vertical space between two or more objects.
- **Space Down Min**—Decreases vertical space between two or more objects.

Edit»Vertex

You can add or remove vertices from all polygons, whether copper or non-copper:

- **Add Vertex**—Adds a vertex to a polygon segment.
- **Remove Vertex**—Remove a vertex from a polygon.

Refer to the *Editing a Polygon* section of Chapter 4, *Working with Parts*, for more information.

Edit»In-Place Part Edit

Use to edit a part that has already been defined and placed on the board. Refer to the *Editing a Placed Part (In-Place Edit)* section of Chapter 4, *Working with Parts*, for more information.

Edit»Properties

Displays the properties of the selected element. Results will differ, depending on what is selected. If no element is selected, displays the board properties. Properties are described throughout this guide.

View Menu

The subjects in this section describe the commands found in the **View** menu.

View»Full Screen

Use to fill the screen with the design only (hide menus, toolbars, other windows). Click the **Close Full Screen** button to return to normal view.

View»Redraw Screen

Use to refresh the screen.

View»Zoom In

Use to zoom in to see more details.

View»Zoom Out

Use to zoom out to see more of the design.

View»Zoom Window

Use to magnify a selected part of the board. Use this command when you want precise control over the workspace view.

View»Zoom Full

Use to return to the full view of the design after zooming in or out. Ctrl-F7 zooms out so that the entire design is visible and centered. This includes the board outline and any objects that may be either inside or outside the board. F7 zooms out so that the board is visible and centered. Any objects outside the board outline will be outside the visible region.

View»Clearances

Use to toggle the clearances around pads, traces and other objects on and off. Refer to the *Placing Traces* section of Chapter 5, *Working with Traces and Copper*, for more information.

View»Grid

Use to toggle the visual grid on and off.

View»Ruler Bars

Use to toggle the ruler bars on and off. Refer to the *Using Ruler Bars and Guides* section of Chapter 4, *Working with Parts*, for more information.

View»Status Bar

Use to toggle the status bar on and off.

View»Density Bars

Use to toggle the density bars on and off. Refer to the *Working with Density Bars* section of Chapter 5, *Working with Traces and Copper*, for more information.

View»Birds Eye

Use to toggle the **Birds Eye View** on and off. Refer to the *Birds Eye View* section of Chapter 1, *User Interface*, for more information.

View»Design Toolbox

Use to toggle the **Design Toolbox** on and off. Refer to the *Design Toolbox* section of Chapter 1, *User Interface*, for more information.

View»Spreadsheet View

Use to toggle the **Spreadsheet View** on and off. Refer to the *Spreadsheet View* section of Chapter 1, *User Interface*, for more information.

View»3D Preview

Toggles the **3D Preview** pane on and off.

View»Toolbars

Use to turn toolbars on or off:

- **Standard**—Use to toggle the **Standard** toolbar on and off. Refer to the *Standard Toolbar* section of Chapter 1, *User Interface*, for more information.
- **View**—Use to toggle the **View** toolbar on and off. Refer to the *View Toolbar* section of Chapter 1, *User Interface*, for more information.
- **Main**—Use to toggle the **Main** toolbar on and off. Refer to the *Main Toolbar* section of Chapter 1, *User Interface*, for more information.

- **Draw Settings**—Use to toggle the **Draw Settings** toolbar on and off. Refer to the *Draw Settings Toolbar* section of Chapter 1, *User Interface*, for more information.
- **Edit**—Use to toggle the **Edit** toolbar on and off. Refer to the *Edit Toolbar* section of Chapter 1, *User Interface*, for more information.
- **Align**—Use to toggle the **Align** toolbar on and off. Refer to the *Align Toolbar* section of Chapter 1, *User Interface*, for more information.
- **Place**—Use to toggle the **Place** toolbar on and off. Refer to the *Place Toolbar* section of Chapter 1, *User Interface*, for more information.
- **Select**—Use to toggle the **Select** toolbar on and off. Refer to the *Select Toolbar* section of Chapter 1, *User Interface*, for more information.
- **Wizard**—Use to toggle the **Wizard** toolbar on and off. Refer to the *Wizard Toolbar* section of Chapter 1, *User Interface*, for more information.
- **Autoroute**—Use to toggle the **Autoroute** toolbar on and off. Refer to the *Autoroute Toolbar* section of Chapter 1, *User Interface*, for more information.

Place Menu

The subjects in this section describe the commands found in the **Place** menu.

Place»From Database

Use to place parts from the database onto the workspace. Refer to the *Placing Parts from the Database* section of Chapter 4, *Working with Parts*, for more information.

Place»Line

Use to place a line or a trace, depending on the active layer. Refer to the *Placing Shapes and Graphics* of Chapter 4, *Working with Parts*, and the *Placing a Trace: Manual Method* section of Chapter 5, *Working with Traces and Copper*, for more information.

Place»Select

Use to change from placing elements to selecting elements.

Place»Follow-me

Use to place a trace between two selected points. Refer to the *Placing a Trace: Follow-me Method* section of Chapter 5, *Working with Traces and Copper*, for more information.

Place»Connection Machine

Use to place a trace between two pads. Refer to the *Placing a Trace: Connection Machine Method* section of Chapter 5, *Working with Traces and Copper*, for more information.

Place»Shape

Use to place shapes of different types:

- **Ellipse**—Use to place an ellipse.
- **Rounded Rectangle**—Use to place a rounded rectangle.
- **Circle**—Use to place a circle.
- **Pie**—Use to place a pie shape.
- **Rectangle**—Use to place a rectangle.
- **Polygon**—Use to place a polygon.

Refer to the *Placing Shapes and Graphics* section of Chapter 4, *Working with Parts*, for more information.

Place»Dimension

Use to place different dimension types:

- **Standard**—Use to place a standard dimension (a dimension to be placed at an angle).
- **Horizontal**—Use to place a horizontal dimension.
- **Vertical**—Use to place a vertical dimension.

Refer to the *Placing Dimensions* of Chapter 4, *Working with Parts*, for more information.

Place»Graphic»Line

Use to place a line or a trace, depending on the active layer. Refer to the *Placing Shapes and Graphics* section of Chapter 4, *Working with Parts*, and the *Placing a Trace: Manual Method* section of Chapter 5, *Working with Traces and Copper*, for more information.

Place»Graphic»Arc

Use to place an arc or a trace, depending on the active layer. Refer to the *Placing Shapes and Graphics* section of Chapter 4, *Working with Parts*, and the *Placing a Trace: Manual Method* section of Chapter 5, *Working with Traces and Copper*, for more information.

Place»Graphic»Bezier

Use to place a bezier or a trace, depending on the active layer. Refer to the *Placing Shapes and Graphics* section of Chapter 4, *Working with Parts*, and the *Placing a Trace: Manual Method* section of Chapter 5, *Working with Traces and Copper*, for more information.

Place»Graphic»Picture

Use to place a bitmap picture on the design. Displays a standard Open dialog.

Select the desired bitmap and click to place it on the design. Drag the bitmap to the desired size, and click the mouse again to place it.

Place»Graphic»Text

Use to place text on the design. Useful for annotation purposes. Refer to the *Placing and Editing Text* section of Chapter 8, *Preparing for Manufacturing/Assembly*, for more information.

Place»Copper Area

Use to define a copper area polygon. Refer to the *Placing Copper Areas* section of Chapter 5, *Working with Traces and Copper*, for more information.

Place»Powerplane

Use to define layers as Power/Ground planes or to clear layers that were previously defined as Power/Ground planes. Refer to the *Placing Powerplanes* section of Chapter 5, *Working with Traces and Copper*, for more information.

Place»Bus

Use to connect multiple traces between multi-pinned devices such as ICs. Refer to the *Placing a Bus* section of Chapter 5, *Working with Traces and Copper*, for more information.

Place»Keep-in/Keep-out Area

Use to define a polygon to restrict elements from either exiting or entering the area. Refer to the *Working with Keep-in/Keep-out Areas* section of Chapter 5, *Working with Traces and Copper*, for more information.

Place»Group Array Box

Use to place parts in a grid array. Refer to the *Placing a Group Array Box* section of Chapter 4, *Working with Parts*, for more information.

Place»Pins

Used during **In-Place Editing** of a part to place a footprint. Refer to the *Editing a Placed Part (In-Place Edit)* section of Chapter 4, *Working with Parts*, for more information.

Place»Via

Use to place a via. Refer to the *Working with Vias* section of Chapter 5, *Working with Traces and Copper*, for more information.

Place»Test Point

Use to place a test point. Refer to the *Working with Test Points* section of Chapter 4, *Working with Parts*, for more information.

Place»Jumper

Use to place a jumper. Refer to the *Working with Jumpers* section of Chapter 4, *Working with Parts*, for more information.

Place»Net Bridge

Places a net bridge on the design. Refer to the *Net Bridges* section of Chapter 5, *Working with Traces and Copper*, for more information.

Place»Hole

Places a hole on the workspace. Refer to the *Placing Holes* section of Chapter 4, *Working with Parts*, for more information.

Place»Automatic Test Points

Use to automatically place a test point on each net on your design. Refer to the *Placing Automatic Test Points* section of Chapter 7, *Autorouting and Autoplacement*, for more information.

Place»Unplace Parts

Use to unplace all non-locked parts. Refer to the *Unplacing Parts* section of Chapter 4, *Working with Parts*, for more information.

Place»Comment

Places a comment on the design. Refer to the *Placing a Comment* section of Chapter 8, *Preparing for Manufacturing/Assembly*, for more information.

Design Menu

The subjects in this section describe the commands found in the **Design** menu.

Design»Netlist & DRC Check

Use to run the design rules and netlist check utility. Results are displayed in the **DRC** tab of the **Spreadsheet View**. Refer to the *Spreadsheet View: DRC Tab* section of Chapter 1, *User Interface*, for more information.

Depending on your settings in the **PCB Design** tab of the **Preferences** dialog box, this utility may run automatically. You can use this command to force a check of the board's integrity, and may want to use it prior to saving or exporting the design.

Design»Connectivity Check

Runs a connectivity check on the design.

When this command is selected, the **Select a Net** dialog box displays. Select the net on which you wish to run the connectivity check and click **OK**.

Results are displayed in the **Results** tab of the **Spreadsheet View**. Refer to the *Spreadsheet View: Results Tab* section of Chapter 1, *User Interface*, for more information.

Design»Polygon Splitter

Use to split a copper area or powerplane. Refer to the *Splitting Copper* section of Chapter 5, *Working with Traces and Copper*, for more information.

Design»Shape to Area

Use to cut out areas in a copper shape to avoid other elements within its area. Refer to the *Converting a Copper Shape to an Area* section of Chapter 5, *Working with Traces and Copper*, for more information.

Design»Swap Pins

Refer to the *Swapping Pins* section of Chapter 5, *Working with Traces and Copper*, for information.

Design»Swap Gates

Refer to the *Swapping Gates* section of Chapter 5, *Working with Traces and Copper*, for information.

Design»Automatic Pin Gate Swap

Refer to the *Automatic Pin/Gate Swapping* section of Chapter 5, *Working with Traces and Copper*, for information.

Design»Part Shoving

Use to toggle shoving on and off. When shoving is on, parts shove any others out of the way when being moved or placed. Refer to the *Shoving Parts* section of Chapter 4, *Working with Parts*, for more information.

Design»Set Reference Point

Use to define the reference point for your board. Refer to the *Setting the Board's Reference Point* section of Chapter 3, *Setting Up a Design*, for more information.

Design»Shield Nets

Use to shields nets. Refer to the *Shielding Nets* section of Chapter 5, *Working with Traces and Copper*, for more information.

Design»Fanout SMD

Use to place a via fanout for a SMD part. Refer to the *Placing SMD Fanouts* section of Chapter 5, *Working with Traces and Copper*, for more information.

Design»Add Teardrops

Use to add teardrops to pads. Refer to the *Adding and Removing Teardrops* section of Chapter 5, *Working with Traces and Copper*, for more information.

Design»Corner Mitering

Use to apply corner mitering before production. Refer to the *Mitering Corners* section of Chapter 8, *Preparing for Manufacturing/Assembly*, for more information.

Design»Remove Unused Vias

Use to delete all vias that do not have any trace segments or copper areas connected to them. Use this command after **Edit»Copper Delete»Open Trace Ends** to clean up the design. Refer to the *Deleting Unused Vias* section of Chapter 8, *Preparing for Manufacturing/Assembly*, for more information.

Design»Group Replica Place

Use to copy and place a group of parts. Refer to the *Replicating a Group* section of Chapter 4, *Working with Parts*, for more information.

Design»Copy Route

Use to copy copper routing between groups. Refer to the *Copying a Copper Route* section of Chapter 5, *Working with Traces and Copper*, for more information.

Design»Highlight Selected Net

Use to select and highlight an entire net when you have selected one trace segment of that net. Refer to the *Highlighting a Net* section of Chapter 5, *Working with Traces and Copper*, for more information.

Tools Menu

The subjects in this section describe the commands found in the **Tools** menu.

Tools»Board Wizard

Assists you in creating a board outline. Refer to the *Working with the Board Outline* section of Chapter 3, *Setting Up a Design*, for more information.

Tools»Part Wizard

Assists you in creating a part and adds it directly to the user database. Refer to the *Using the Part Wizard to Create a Part* section of Chapter 4, *Working with Parts*, for more information.

Tools»Database»Database Manager

Use to manage the database of parts available to you. Refer to the *Managing the Database* section for more information.

Tools»Database»Add Selection to Database

Use to place the selected part in the database. Refer to the *Adding Parts to the Database* section of Chapter 4, *Working with Parts*, for more information.

Tools»Database»Set Database Password

Use to set a password for access to database functions that make any changes to a database.

Complete the following steps to set a password for a database:

1. Select **Tools»Set Database Password**.
2. Select the desired database from the **Database** drop-down list.
3. Enter the new password in the **Password** field and re-enter it in the **Confirmation** field.
4. Click **OK** to save the password.

Tools»Database»Merge Database

Use to convert existing part databases to Ultiboard 10.1 format. Refer to the *Merging Databases* section of Chapter 4, *Working with Parts*, for more information.

Tools»Database»Convert Database

Use to update your old **User** and **Corporate** databases to Ultiboard 10 format. Refer to the *Converting Databases* section of Chapter 4, *Working with Parts*, for more information.

Tools»PCB Transmission Line Calculator

Use to calculate parameters for typical printed circuit board trace geometries. Refer to the *PCB Transmission Line Calculator* section of Chapter 6, *PCB Calculators*, for more information.

Tools»PCB Differential Impedance Calculator

Use to perform calculations for two traces that carry signals that are exactly equal and opposite (a differential pair). Refer to the *PCB Differential Impedance Calculator* section of Chapter 6, *PCB Calculators*, for more information.

Tools»Netlist Editor

Use to remove or add nets and pads. Refer to the *Using the Netlist Editor* section of Chapter 5, *Working with Traces and Copper*, for more information.

Tools»Group Editor

Use to set up and edit various group types. Refer to the *Working with the Group Editor* section of Chapter 3, *Setting Up a Design*, for more information.

Tools»Quick Layer Toggle

Use to toggle between the last copper layer or to the opposite copper layer if the last layer was not copper.

Tools»Renumber Parts

Use to renumber parts in preparation for production. Refer to the *Renumbering Parts* section of Chapter 8, *Preparing for Manufacturing/Assembly*, for more information.

Tools»Equi-space Traces

Use to equally space selected traces. Refer to the *Equi-Spacing Traces* section of Chapter 5, *Working with Traces and Copper*, for more information.

Tools»Change Shape

Use to substitute a part from the database for the current selected part. Refer to the *Replacing Parts* section of Chapter 4, *Working with Parts*, for more information.

Tools»Update Shapes

Use if you loaded Ultiboard V. 5 files into Multisim and plan to use 3D. This command adds the necessary 3D information to the footprints in the file.

Tools»Highlight Selection in Multisim

Highlights a selected part in Multisim. Refer to the *Cross-probing* section of Chapter 4, *Working with Parts*, for more information.

Tools»Capture Screen Area

You can take a screen capture of a selected area. Refer to the *Capturing Screen Area* section of Chapter 8, *Preparing for Manufacturing/Assembly*, for more information.

Tools»View 3D

Displays the design in 3D mode. Refer to the *Viewing Designs in 3D* section of Chapter 9, *Viewing Designs in 3D*, for more information.

Tools»View 3D Position

This is only available when viewing the design in the 3D mode. Refer to the *Manipulating the 3D View* section of Chapter 9, *Viewing Designs in 3D*, for more information.

Tools»Show or Hide Height

Shows or hides the height of selected objects in 3D mode. This is only available when viewing the design in the 3D mode. Refer to the *Showing an Object's Height* section of Chapter 9, *Viewing Designs in 3D*, for more information.

Options Menu

The subjects in this section describe the commands found in the **Options** menu.

Options»Global Preferences

Displays the **Preferences** dialog box. Refer to the *Setting Preferences* section of Chapter 1, *User Interface*, for more information.

Options»PCB Properties

Use to define the general parameters of your PCB design. Refer to the *Setting PCB Properties* section of Chapter 1, *User Interface*, for more information.

Options»Customize User Interface

Use to customize your menus, toolbars and context menus. Refer to the *Customizing the Interface* section of Chapter 1, *User Interface*, for more information.

Autoroute Menu

Refer to the *Autoroute Menu Items* section of Chapter 1, *User Interface*, for information about the commands in this menu.

Window Menu

The subjects in this section describe the commands found in the **Window** menu.

Window»New Window

Use to display a new window containing a full view of the design currently open.

Window»Close

Use to close selected window.

Window»Close All

Use to close all open windows.

Window»Cascade

Use to cascade the open windows, so they are arranged one on top of the next while remaining separately selectable.

Window»Tile Horizontal

Use to adjust two or more windows so that they sit one on top of the other.

Window»Tile Vertical

Use to adjust two or more windows so that they sit beside each other.

Window»Windows

Displays the **Windows** dialog box where you can show or close the files that you currently have open

Window»<open designs>

Shows all open design windows.

Help Menu

The subjects in this section describe the commands found in the **Help** menu.

Help»Ultiboard Help

Use to display the contents of the online help.

Help»Release Notes

Use to display the Ultiboard release notes.

Help»Patents

Displays a file with a list of National Instruments software-related patents.

Help»File Information

Displays the **File Information** dialog box.

Help»About Ultiboard

Use to display the version numbers of your copy of Ultiboard.

Context Menus

Depending on the action, the following context sensitive menus display when the right mouse button is clicked:

- *Select Menu*
- *Right-drag Menu*
- *Place Trace Menu*

Select Menu

When you select an object or objects in a design and then right-click your mouse, a context menu with the following options displays.

Cut

Removes the selected element(s) from the board. Element is placed on the Windows Clipboard and can be pasted again.

Paste

Pastes the item on the Windows Clipboard to its original layer (regardless of what layer is currently active). Creates new duplicate object(s) without the netlist information. New parts will have Reference Designators that increment from the next available for that part type. For example, if the last resistor was R34, and a resistor is pasted, its Reference Designator will be R35.

Copy

Copies the selected elements and stores them on the Windows Clipboard so they can be pasted again.

Delete

Deletes the selection from the design.

Select All

Selects all items on the design.

Select Entire Trace

Use to select a whole trace when one or more segments of the same trace are selected.

Quick Layer Toggle

Use to toggle between the last copper layer or to the opposite copper layer if the last layer was not copper.

Lock

Locks the selected elements in place so they cannot be moved.

Unlock

Unlocks the selected elements.

Place

Displays a number of elements that you can place on the design.

Shape

Displays a number of shapes that you can place on the design.

Orientation

Use these commands to adjust the orientation of parts as they are placed on a design.

Align

Use these commands to align the edges of the elements.

Vertex

Use to add or remove vertices from all polygons, whether copper or non-copper.

In-Place Part Edit

Switches to **In-Place Edit** mode for the selected item. Refer to the [Editing a Placed Part \(In-Place Edit\)](#) section of Chapter 4, [Working with Parts](#), for more information.

Properties

Displays the properties dialog box for the type of element selected. Refer to the [Viewing and Editing Properties](#) section of Chapter 4, [Working with Parts](#), for more information.

Right-drag Menu

When you select an area by dragging and releasing the right mouse button, a context menu appears with the following selections.

Select all in rectangle

Selects all objects in the rectangle that you “drew” by dragging and releasing the right mouse button.

Select objects on active layer

Selects only those objects in the rectangle that you “drew” by dragging and releasing the right mouse button that are on the active layer as defined in the **Layers** tab of the **Design Toolbox**.

Select objects on specified layers

Displays the **Select layer(s)** dialog box.

Complete the following steps to select the layers on which you wish to select the objects:

1. Highlight the desired layers in the **Select layer(s)** dialog box and click **OK**.
2. All items that are on the selected layers that appear within the rectangle that you “drew” by dragging the right mouse button are selected.

Place Trace Menu

If you click the right mouse button when you are placing a trace a context sensitive menu displays with the following options.

Cancel

Cancels the placement of the trace segment being drawn.

Widen

Widens the trace that you are drawing. Should be within **Minimum Width** when set.

Narrow

Narrows the trace that you are drawing. Should be within **Minimum Width** when set.

Archiving Data

National Instruments recommends that you regularly back up the files created within the Multisim and Ultiboard components of NI Circuit Design Suite. Additionally, you should back up internal files that store user-created data, such as database components. This section provides information on where to find these files in order to properly back them up.

NI Circuit Design Suite stores program and user data in two possible locations. Files that need to be accessed on a per-machine basis are stored in different locations, depending on the operating system. Files that are created on a per-user basis are stored in the Windows per-user folder. Multisim and Ultiboard share the same three database files: **Master**, **Corporate**, and **User**.

Backing up the Corporate Database

Windows XP and Windows 2000

The default **Corporate** database location for Windows XP and Windows 2000 is `C:\Documents and Settings\All Users\Application Data\National Instruments\Circuit Design Suite\10.1\database\`.

The file name for the **Corporate** database is `CPCOMP_S.PRJ`.

The Application Data folder is a system folder and thus may be hidden.

Complete the following steps to view this folder:

1. Open a standard Windows explorer window.
2. Select **Tools»Folder Options**.
3. Select the **View** tab, **Show hidden files and folders**, **OK**.

Windows Vista

The default **Corporate** database location for Windows Vista is `C:\ProgramData\National Instruments\Circuit Design Suite\10.1\database\`.

The file name for the **Corporate** database is `CPCOMP_S.PRJ`.

The ProgramData folder is a system folder and thus may be hidden.

Complete the following steps to view this folder:

1. Open a standard Windows explorer window.
2. Select **Organize»Folder & Search Options**.
3. Select the **View** tab, **Show hidden files and folders, OK**.



Note The default location for the **Corporate** database can change if the database has been configured to be shared across a network drive. Check the **Preferences** dialog box to find the location of this database. Refer to the *Paths Tab* section of Chapter 1, *User Interface* for more information.

Backing up the User Database and Configuration files

Windows XP and Windows 2000

For Windows XP and Windows 2000, the **User** database is stored at:

```
C:\Documents and Settings\\Application  
Data\National Instruments\Circuit Design  
Suite\10.1\database\.
```

The file name for the **User** database is `UsrComp_S_<user name>.usr`.

The user's configuration file is stored at:

```
C:\Documents and Settings\\Application  
Data\National Instruments\Circuit Design  
Suite\10.1\config\.
```

The Application Data folder is a system folder and thus may be hidden.

Complete the following steps to view this folder:

1. Open a standard Windows explorer window.
2. Select **Tools»Folder Options**.
3. Select the **View** tab, **Show hidden files and folders, OK**.

Windows Vista

For Windows Vista, the **User** database is stored at:

```
C:\Users\\AppData\Roaming\National  
Instruments\10.1\database\.
```

The file name for the **User** database is `UsrComp_S_<user name>.usr`.

The user's configuration file is stored at:

```
C:\Users\\AppData\Roaming\National  
Instruments\10.1\config\.
```

The AppData folder is a system folder and thus may be hidden.

Complete the following steps to view this folder:

1. Open a standard Windows explorer window.
2. Select **Organize»Folder & Search Options**.
3. Select the **View** tab, **Show hidden files and folders, OK**.



Note You can change the locations of the configuration files and **User** database from the **Preferences** dialog box. Refer to the *Paths Tab* section of Chapter 1, *User Interface* for more information.



Technical Support and Professional Services

Visit the following sections of the award-winning National Instruments Web site at ni.com for technical support and professional services:

- **Support**—Technical support resources at ni.com/support include the following:
 - **Self-Help Technical Resources**—For answers and solutions, visit ni.com/support for software drivers and updates, a searchable KnowledgeBase, product manuals, step-by-step troubleshooting wizards, thousands of example programs, tutorials, application notes, instrument drivers, and so on. Registered users also receive access to the NI Discussion Forums at ni.com/forums. NI Applications Engineers make sure every question submitted online receives an answer.
 - **Standard Service Program Membership**—This program entitles members to direct access to NI Applications Engineers via phone and email for one-to-one technical support as well as exclusive access to on demand training modules via the Services Resource Center. NI offers complementary membership for a full year after purchase, after which you may renew to continue your benefits.

For information about other technical support options in your area, visit ni.com/services, or contact your local office at ni.com/contact.
- **Training and Certification**—Visit ni.com/training for self-paced training, eLearning virtual classrooms, interactive CDs, and Certification program information. You also can register for instructor-led, hands-on courses at locations around the world.
- **System Integration**—If you have time constraints, limited in-house technical resources, or other project challenges, National Instruments Alliance Partner members can help. To learn more, call your local NI office or visit ni.com/alliance.

If you searched ni.com and could not find the answers you need, contact your local office or NI corporate headquarters. Phone numbers for our worldwide offices are listed at the front of this manual. You also can visit the Worldwide Offices section of ni.com/niglobal to access the branch office Web sites, which provide up-to-date contact information, support phone numbers, email addresses, and current events.

Glossary

Symbol	Prefix	Value
p	pico	10^{-12}
n	nano	10^{-9}
μ	micro	10^{-6}
m	milli	10^{-3}
k	kilo	10^3
M	mega	10^6
G	giga	10^9
T	tera	10^{12}

A

- Active Layer The layer on which any actions you choose will be performed.
- All Angle Routing Routing that allows both 90° and 45° angles.
- Aperture Code Identifies the type of aperture to be used by the Gerber output.

B

- Birds Eye View The small window that appears, by default, at the top left of the screen.
Gives you an overview of your complete PCB, with parts shown as outlines.
Allows you to quickly navigate through your board or display a specific area of the design, sized as you wish.
- Blind Via A via that connects the top or bottom layer with any inner layer.
- Buried Via A via that connects inner layers.

C

Chamfer Corners	Corners at an increment of 45° on the trace routes.
Copper Area	A copper polygon.
Copper Island	A copper area that is not connected to any other copper.

D

Design Toolbox	By default, appears on left side of screen. Consists of multiple tabs used to manage a design.
DRC	Design Rule Check.

F

Feedthrough Via	A normal via that connects all layers, top, bottom and inner.
Force Vector	A line that indicates the optimal location for a part, considering all the connections of the part to achieve the shortest possible connections.

G

Grid	Determines the increments by which traces can be placed on the board.
------	---

M

Mouse Grid	Controls the increments by which the cursor moves and where items are placed.
------------	---

N

Net	A network of traces, to which you can add pins and copper areas.
Netlist	Contains connectivity information about pins and parts.
Normal Feed-Through Via	Any via that connects all layers (top, bottom, and internal).

O

Output Window Gives you useful information on the status of your design. By default, is turned off.

P

Pad Stack The connections between layers of the board.

Part Grid Determines the increments by which elements (parts and shapes) can be placed on the board.

Prepreg Prepreg is fiber glass that is pre-impregnated with resin to make it semi-rigid. Prepreg sheets can then be placed between the copper foil and heated under pressure to activate and set the resin.

R

Ratsnest Visual display showing linear connections between pins, using the shortest possible line. A guide for pin connections, not a realistic representation of the board.

RefDes Reference designator, the unique name given to a net.

Reference Point The point from which coordinates are calculated, in normal mode. Set using **Design»Set Reference Point**.

S

SMD Pad A pad without a drill hole (drill diameter property in the pad code set to 0).

Status Bar Displays useful and important information at the bottom of your screen.

T

Thermal Relief	Area around a pin where no copper appears, but which is crossed by copper lines to make connections. A thermal relief is used to dissipate heat during the soldering process.
Through-Hole Via	Normal via.
Trace Code	The system provides 32 trace codes, each with a width and clearance. “Clearance” describes the space required between pads and pads, between traces and pads, and between traces and traces. This free space is continuously checked by the real-time design rule check. Trace code specifications can be exported as part of the design rules.

V

Vertex	A vertex is a point of a polygon. A side of a polygon connects two vertices.
Via	A plated through-hole in a printed circuit board used to route a trace vertically (from one layer to another).
Visual Grid	Provides a visual reference for you to visually align parts and traces.

W

Workspace	The part of the screen where you build your design.
-----------	---

Index

Numerics

3D view

- controlling elements in, 9-3
- manipulating, 9-2
- using, 9-1
- Viewer options, 1-19

A

- Add groups dialog box, 3-11
- Add Net dialog, 5-21
- Adding teardrops, 5-13
- Advanced Net Shielding Options dialog, 5-28
- Align command, A-6
- Align toolbar, 1-8
- alignment of parts, 4-11
- attribute
 - names, 4-15
 - properties, 4-19
 - values, 4-15
 - visibility, 4-15
- attributes
 - about, 4-15
 - deleting, 4-15
- autoloading, 1-13
- automatic testpoints, 7-10
- autoplacer
 - about, 7-2
- autoplacing parts, 7-2
- Autoroute menu items, 7-1
- autorouter
 - about, 7-6
- autosaving, 1-13

B

- backannotation, 8-6
- Bill of Materials
 - exporting, 8-12
- birds eye view, 1-28
- block capacitor placement, 7-2
- board
 - adding layers, 1-24
 - cleaning up before manufacturing, 8-8
 - number of layers, 1-24
 - removing layers, 1-24
 - statistics export properties, 8-12
- board outline
 - creating, 3-5
 - drawing, 3-5
 - from database, 3-6
 - importing, 3-6
 - using wizard, 3-7
- board properties
 - about, 1-20
 - displaying, 1-20
 - grids and units, 1-20
- Button Appearance dialog, 1-49

C

- capturing screen area, 8-2
- Change group settings dialog box, 3-18
- Choose Net and Layer for Powerplane dialog, 5-11
- circles
 - placing, 4-21
- Close All command, A-2
- Close command, A-2
- Close Project command, A-2
- clusters, 7-2

- color
 - controlling, 1-15
 - mechanical CAD design, 10-3
 - schemes, setting up, 1-15
 - configuration files
 - back-up, B-2
 - connection machine trace
 - custom routing, 5-4
 - placing, 5-4
 - using, 5-4
 - Connectivity check, A-14
 - Connectivity tab, 1-32
 - connectors
 - placing, 4-21
 - conventions used in the manual, *vi*
 - copper
 - deleting, 5-12
 - sharing, 7-7
 - splitting, 5-11
 - copper areas
 - placing, 5-10
 - copper polygons
 - placing, 5-10
 - Copy command, A-4, A-22
 - corner mitering, 8-6
 - corporate database
 - back-up, B-1
 - cross-probing, 4-35
 - Customize dialog
 - Commands tab, 1-47
 - Keyboard tab, 1-48
 - Menu tab, 1-48
 - Options tab, 1-49
 - pop-up menus, 1-49
 - Toolbars tab, 1-47
 - Cut command, A-4, A-22
- D**
- database
 - adding parts to from design, 4-45
 - adding parts to using
 - Database Manager, 4-45
 - categories, about, 4-43
 - categories, copying, 4-43
 - categories, creating, 4-43
 - managing, 4-41
 - placing parts from, 4-27
 - sub-categories, deleting, 4-44
 - database categories
 - about, 4-43
 - copying, 4-43
 - creating, 4-43
 - Database Manager
 - about, 4-41
 - panels of, 4-41
 - using to create parts, 4-35
 - Database merge, 4-46
 - database sub-categories
 - deleting, 4-44
 - Delete command, A-4
 - density bars, 5-6
 - design
 - adding parts to database, 4-45
 - adding to project, 2-2
 - closing, 2-5
 - creating, 2-2
 - preview print, 8-15
 - printingprint negative, 8-14
 - refreshing, 2-11
 - saving, 2-5
 - viewing in 3D, 9-1
 - design rule check
 - running, 8-8
 - type of errors, 3-10
 - using, 3-10
 - design rule errors
 - viewing, 3-10
 - Design Toolbox
 - overview, 1-27
 - using, 4-2
 - diagnostic tools (NI resources), C-1

- dimensions
 - default, 1-18
 - placing, 4-25
 - properties, 4-26
 - type, 4-25
- documentation
 - conventions used in the manual, *vi*
 - NI resources, C-1
- DRC
 - running, A-14
- DRC tab, 1-30
- drivers (NI resources), C-1
- Duplicate Component Name dialog, 4-46
- DXF
 - export properties, 8-11
 - importing, 3-6
 - importing into mechanical CAD design, 10-3

E

- Edit Groups dialog, 3-11
 - Bus Groups tab, 3-15
 - Differential Pairs tab, 3-17
 - Net Groups tab, 3-12
 - Part Groups tab, 3-13
- Edit menu, A-3
- Edit toolbar, 1-7
- editing net widths, 5-26
- elements
 - searching for, 2-8
 - selecting, 2-7
 - unselecting, 2-7
- ellipses
 - placing, 4-21
- Enter coordinate dialog, 3-9
- equi-space traces, 5-9
- examples (NI resources), C-1
- Exit command, A-3
- export
 - properties, 8-10

- settings, 8-9
- Export command, A-2

F

- Fanout Options dialog, 5-18
- fiducial marks, 1-15
- file
 - export properties, 8-10
 - export settings, 8-9
 - exporting, 8-14
 - exporting - about, 8-8
 - locations, 1-14
- File menu, A-1
- files
 - closing, 2-5
 - opening, 2-4, 2-5
 - removing design from, 2-4
 - renaming, 2-4
 - saving, 2-5
- Filter Manager, 1-31
- Find command, A-5
- Find tab, 1-32
- follow me trace
 - about, 5-3
 - placing, 5-3
- force vectors
 - about, 4-6
- full autorouter
 - running, 7-8
- full autorouter
 - about, 7-8
- full screen view, 2-9

G

- Gerber export properties, 8-10
- grid
 - visible, 1-20
- Group command, A-5

guides

- moving, 4-10
- placing, 4-10
- removing, 4-10
- using, 4-10

H

- help, technical support, C-1
- highlighting in Multisim, 4-35

I

- initial routing, 7-7
- in-place edit
 - using, 4-29
- In-Place Part Edit command, A-7
- instrument drivers (NI resources), C-1
- interface elements, 1-1

J

- jumper properties, 4-23
- jumpers
 - default pin diameters, 1-15
 - placing, 4-23

K

- Keep-in/Keep-out areas
 - placing, 5-7
 - properties, 5-7
- KnowledgeBase, C-1

L

- lamination settings, 3-1
- layers
 - adding to board, 1-24
 - choosing how many, 3-1
 - lamination settings, 3-1

- multi-layered boards, 3-1
- number on the board, 1-24
- PCB layers, 3-3
- removing from board, 1-24
- swapping parts on, 4-11
- tab, using, 3-3

Layers tab

- using, 3-3
- leave drill holes open, 8-14
- lines
 - placing, 4-21
- Lock command, A-5, A-23

M

- manual trace
 - placing, 5-2
- measurement guides, 4-10
- mechanical CAD
 - colors, 10-3
 - dimensions, 10-5
 - paths, 10-5
 - properties, 10-3
 - workspace elements, 10-4
- mechanical CAD design
 - creating, 10-2
 - importing DXF file, 10-3
- mechanical CAD files
 - creating, 10-1
- mitering corners, 8-6
- modes, 2-8
- mounting holes
 - placing, 4-21
- multi-layered boards, 3-1

N

- National Instruments support and services, C-1
- NC drill properties, 8-11

- net
 - adding, 5-21
 - deleting, 5-25
 - deleting pad from, 5-26
 - renaming, 5-25
 - Net Edit dialog
 - Groups tab, 5-27
 - Via tab, 5-28
 - Net edit dialog
 - High Speed tab, 5-26
 - Misc tab, 5-27
 - Net Shielding dialog, 5-28
 - netlist
 - importing, 2-2
 - netlist check
 - running, 8-8, A-14
 - Netlist Editor
 - about, 5-20
 - opening, 5-20
 - Nets tab
 - using, 5-19
 - New command, A-1
 - New Group Array Properties dialog, 4-12
 - New Project command, A-1
 - NI support and services, C-1
- O**
- Open command, A-1
 - open trace ends, deleting, 8-8
 - optimization, 7-8
 - Options command, A-20
 - Orientation command, A-6, A-23
- P**
- pads
 - deleting from net, 5-26
 - Part Wizard
 - using, 4-36
 - parts
 - adding to database from design, 4-45
 - adding to database using command, 4-45
 - adding to database using Database Manager, 4-45
 - aligning, 1-8, 4-11
 - angle of, 4-11
 - centroids properties, 8-13
 - creating using Database Manager, 4-35
 - creating using the Part Wizard, 4-36
 - dragging, 4-7
 - editing (once placed), 4-29
 - finding, 4-4
 - flipping, 4-11
 - locating in open design, 4-34
 - locking, 4-4
 - orienting, 4-11
 - placing from the database, 4-27
 - placing multiple, 4-3
 - placing single, 4-3
 - placing using Design Toolbox, 4-2
 - position, 4-17
 - pre-placing, 7-2
 - previewing, 4-4
 - properties, 4-17
 - relocating, 4-7
 - renumbering, 8-5
 - replacing, 4-35
 - rotating, 4-11
 - searching for in open designs, 4-34
 - spacing, 4-12
 - swapping layer, 4-11
 - unlocking, 4-4
 - Parts tab
 - using, 4-4
 - Paste command, A-4, A-22
 - PCB
 - layers, 3-3
 - toolbar, 1-4
 - PCB design
 - default actions, 1-15
 - viewing options, 1-15

- PCB Differential Impedance Calculator, 6-7
- PCB Properties
 - Board Default tab, 1-25
- PCB Transmission Line Calculator, 6-1
- pin type
 - test point, 4-25
- Place toolbar, 1-9
- placement
 - strategies, 7-5
- placing a comment, 8-3
- placing powerplanes, 5-11
- Placing SMD Fanouts, 5-18
- placing traces, 5-1
- placing vias, 5-15
- polygon
 - editing, 4-30
 - placing, 4-21
 - placing copper, 5-10
 - splitting, 5-11
- position
 - of parts, 4-17
- powerplanes
 - placing, 5-11
- preferences
 - Preferences dialog, 1-13
- pre-placed traces, 7-8
- pre-placing parts, 7-2
- print
 - leave drill holes open, 8-14
 - negative, 8-14
 - reflection, 8-14
- Print command, A-3
- print reflection, 8-14
- programming examples (NI resources), C-1
- project files
 - creating, 2-1
- projects
 - renaming, 2-1
- properties
 - shape, 4-20

R

- ratsnest
 - about, 4-5
- rectangles
 - placing, 4-21
- redlining, 8-3
- Redo command, A-3
- reference point, 3-8
- ReNUMBER parts dialog, 8-5
- rip-up and retry
 - algorithm, 7-2
 - routing, 7-7
- router
 - cleanup, 7-7
- router pin/gate swap, 7-11
- router preprocessing, 7-7
- routing
 - initial, 7-7
- routing functions
 - running together, 7-8
- Routing Options dialog
 - Autoplace tab, 7-3
 - Bus Autorouting tab, 7-16
 - Cost Factors tab, 7-12
 - General tab, 7-11
 - Optimization tab, 7-15
 - Rip-up tab, 7-14
- Routing strategies, 7-17
- rubber banding, 4-7
- ruler bars
 - toggling on and off, 4-10
 - using, 4-10

S

- Save All command, A-2
- Save As command, A-2
- Save command, A-1
- Select a Net dialog, A-14
- Select All command, A-5
- Select Groups for Replica Place dialog, 4-14

- Select toolbar, 1-5
- Selection Filter command, A-6
- selection filtering, 2-7
- Setting database password, A-17
- shape
 - properties, 4-20
- shapes
 - placing, 4-21
- shoving
 - toggling on and off, 4-7
- SMT pin
 - properties, 4-33
- software (NI resources), C-1
- spacing of parts, 4-12
- Spreadsheet View, 1-29
- strategies for 100% part placement, 7-5
- support
 - technical, C-1
- surface mount pad oversize, setting, 1-24
- swap
 - router pin/gate, 7-11

T

- Teardrops dialog, 5-13
- technical support, C-1
- Technology File Settings dialog, 2-6
- test points
 - pin type, 4-25
 - placing, 4-24
 - properties, 4-25
 - wire type, 4-25
- testpoints
 - default pin diameters, 1-15
- text
 - placing, 8-1
- through hole pin
 - properties, 4-31
- tolerance oversize value, 1-24
- Tool-tip label, 2-11
- trace
 - deleting open ends, 8-8

- trace ends, deleting open, 8-8
- trace hugging, 7-7
- trace spacing
 - equi-space, 5-9
- traces
 - deleting, 5-9
- training and certification (NI resources), C-1
- troubleshooting (NI resources), C-1

U

- Undo command, A-3
- Unlock command, A-5, A-23
- unused vias, deleting, 8-8
- user database
 - back-up, B-2
- user settings files, 1-14

V

- Vertex command, A-7
- via properties, 5-16
- vias
 - about, 5-15
 - deleting unused, 8-8
 - placing, 5-15
- view
 - full screen, 2-9
 - magnifying, 2-10
 - shrinking, 2-10
- visible grid
 - setting, 1-20

W

- Web resources, C-1
- wire type
 - test point, 4-25
- Wizard toolbar, 1-12
- workspace
 - options, 1-13