



DB-25HD



DBC-25HD

USER MANUAL

POTATO PEELER

Models:

DB-25HD- WITH FEET

DBC-25HD- WITH PEEL STRAINER

Summary

1. Introduction	02
1.1 Safety	02
1.2 Main Components	02
1.3 Technical Characteristics	04
2. Installation and Pre Operation	04
2.1 Installation	04
2.2 Pre Operation	05
3. Operation	05
3.1 Proceeding for Operation	05
3.2 Cleaning	06
4. General Safety Rules	07
4.1 Basic Operation Procedures	08
4.2 Safety Procedures and Notes Before Switching the Machine On	08
4.3 Routine Inspection	09
4.4 Operation	09
4.5 After Finishing the Task	10
4.6 Maintenance Operation	10
4.7 Warnings	10
5. Problemas Analysis and Solutions	10
5.1 Problems, Causes e Solutions	10
5.2 Adjustment and Components Replacement	11
5.3 Elesectrical Diagram	11

1. Introduction

1.1 Safety

When misused, the Potato Peelers DB-25HD and DBC-25HD can be potentially DANGEROUS. Maintenance, cleaning or any other service on this machine must be made only by properly trained technicians and the power plug must be disconnected. For your safety, the following instructions must be followed in order to avoid accidents:

1.1.1 - Unplug the machine when you need to remove any removable part during cleaning, maintenance or any other operation.

1.1.2 - Never make use of any tool or instrument that is not originally part of the machine during any operation.

1.1.3 - Do never touch the Abrasive Disc N°07 (Pic.01) when the machine is working, because it has abrasive surface.

1.1.4 - Keep hands away from mobile parts.

1.1.5 – When replacing the Abrasive Disc N°07 (Pic.01), check its perfect fit to the Central Shaft Pin N°02 (Pic.02). That is a way to avoid damages to the machine.

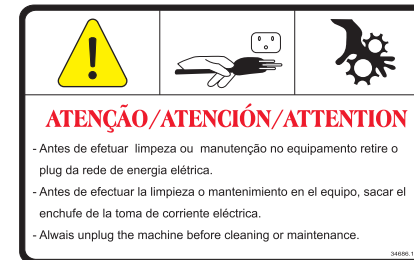

IMPORTANT

This equipment is not to be used by persons (including children) with any physical or mental disabilities, or without operation experience and knowledge, only acquired by means of instruction and supervision of a security staff.

IMPORTANT

If the Cord is not in good conditions of use, to avoid accidents it must be replaced by the supplier, an authorized technician or someone qualified for the service.

1.2 Main Components

All components of this machine were made of raw materials carefully selected for each function, according to the test patterns and Siemens experience.

Picture - 01



- 01 –Water Entrance
- 02 – Door Base
- 03 – ON/OFF Switch
- 04 – Foot
- 05 – Lid
- 06 – Timer
- 07 – Abrasive Disc
- 08 – Door
- 09 – Exit Tube
- 10 – Housing

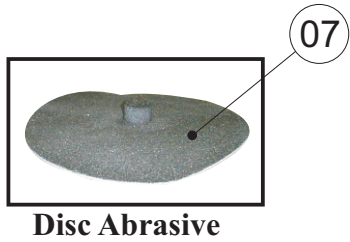

Disc Abrasive

Picture - 02

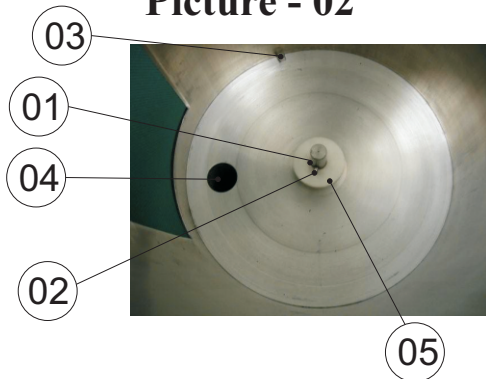

- 01 – Central Shaft
- 02 – Central Shaft Pin
- 03 – Lock
- 04 – Residue exit
- 05 – Rubber ring

Table - 02

<i>Problems</i>	<i>Causes</i>	<i>Solution</i>
* The machine does not turn ON.	* Power outage * Problem on the internal or external electric circuit of the machine.	* Check if there is Electric Power * Call Technical Assistance.
* Burnt smell or smoke	* Problem on the internal or external electric circuit of the machine.	* Call Technical Assistance.
* The machine turns on, but when product is placed upon the Disc, it stops or spins in low rotation.	* Skidding belts * Problems with the Electric Motor	* Call Technical Assistance. * Call Technical Assistance.
* Strange noises.	* Abrasive Disc misplaced * Damaged Ball Bearings	* Place the Abrasive Disc appropriately on the Central Shaft Pin. * Call Technical Assistance.
* Water leak in the bottom of the machine.	* Damaged retainer.	* Call Technical Assistance.

5.2 Adjustments and Replacement of Components

The Abrasive Disc is covered with an Aluminum Oxide layer, responsible for the food peeling. After some time, the Aluminum Oxide wears out and the efficiency of the machine decreases consequently.

Then, the Abrasive Disc must be taken to the nearest Technical Assistance to be recoated.

5.3 Electrical Diagram

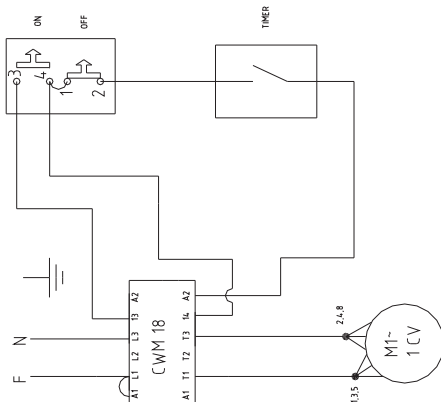

1.3 Technical Characteristics

Table - 01

Technical Characteristics	DB-25HD	DBC-25HD
Voltage [V]	110 ou 220V	110 ou 220V
Power Rating [CV]	1	1
Consumption [kW/h]	0,73	0,73
Height/Width/Depth [mm]	1160x550x670	1370x550x670
Net/Gross weight [kg]	45/53	58/66
Capacity [kg]	25	25
Average Production [kg/h]	500	500

(*) There will be a single frequency option (50 or 60 Hz), depending on machine motor type.

2. Installation and Pre-Operation

2.1 Installation

The Potatoes Peeler must be installed onto a stable working surface. Verify the voltage of the power SOURCE it will be connected to (110V or 220V).

The Cord brings a plug with 2 (two) flat pins and 1 (one) round pin which is for grounding (ground wire pin). It is mandatory that the three pins are properly connected before using the equipment.

It is recommendable to install the machine close to a sewer or to canalize the residues, by extending the Exit Tube N°09 (Pic.01), located on the lower part of the machine. The model DBC-25HD brings a peel strainer. The water entrance N°01 (Pic. 01) must be connected to a tap, to allow water to run directly over the potatoes to be peeled.

The water outpour that enters the equipment must not pass beyond the center of the disc, as indicated in the drawing-01

The water outflow not exceed 3 liters per minute.

Drawing - 01

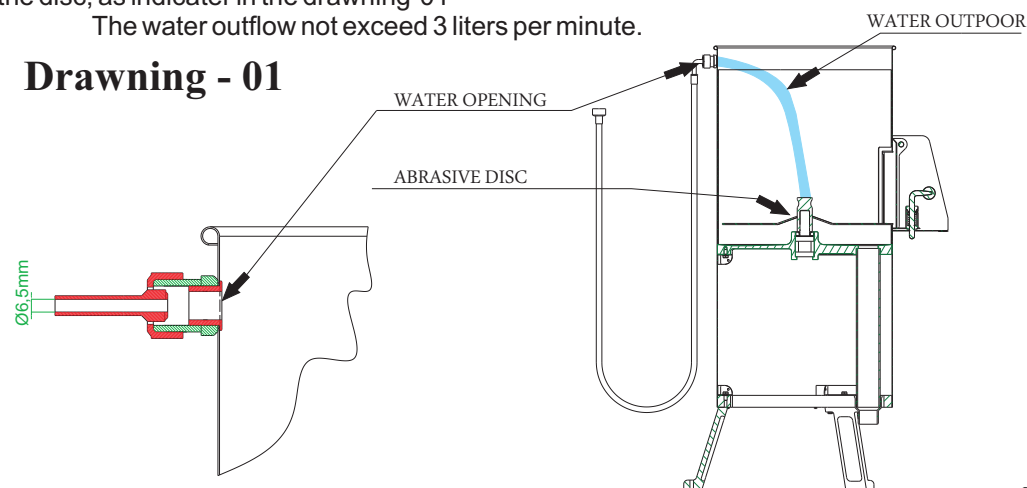

2.2 Pre-Operation

IMPORTANT

Make sure the Abrasive Disc N°07 (Pic.01) is well placed on Central Shaft Pin N°02 (Pic.02) before switching the machine on.

Check if the Potato Peeler is firm in its position. Install the water entrance and exit.

Check if the inner abrasive disc and walls are properly placed. Observe the link Pic.06 attachment with the lock, N°. 03 (Pic. 02).

3. Operation

3.1 Proceeding for operation

IMPORTANT

Under no circumstances touch the Abrasive Disc when it is in movement.

Remove the lid N°. 05 (Pic. 01) open the water tap, set the timer N°. 06 (Pic. 01) and activate the ON / OFF Switch N°. 03 (Pic. 01). With the machine on, pour the product to be processed inside it, and replace the lid.

For both models DB – 25HD and DB/C – 25HD put 25 kg of potatoes at most. The working time varies from 1 to 5 minutes. In case the product to be peeled is too irregular, it is possible to watch when it's done through the Lid opening. To remove the peeled product, keep the machine running and open the Door N°01 (Pic.03), by pulling the lock N°. 02 (Pic. 03) upwards. Lift it until the side lock N°. 03 (Pic. 03) keep the door N°. 01 (Pic. 03) open. This way the product will be expelled. To close the door release the side lock N°. 03 (Pic. 03), by pulling it sideward.

SKYMSSEN TIP

The Potato Peelers can also be used to peel carrots, chayote, oranges and others similar.

Pic.03

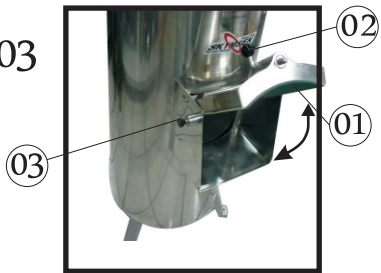

Pic.04

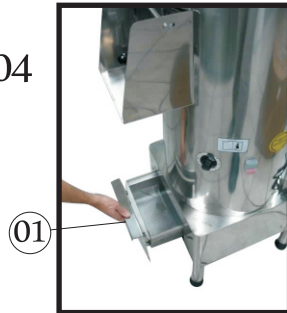

MODELO
DBC-25HD

For the model with Peel Strainer, check the volume of residue and remove the drawer N°. 01 (Pic. 04) on each process (25Kg).

4.5 After Finishing the Work

4.5.1 Precautions

Keep the machine clean. Always TURN THE MACHINE OFF by removing the plug from the socket before cleaning it.

Never clean the machine unless it has come to a complete stop.

Put all components back to their functional positions before turning it ON again.

Check level of oil.

DO NOT place your fingers in between belts and pulleys nor chains and gears.

4.6 Maintenance Operation.

4.6.1 Danger

Every maintenance operation is dangerous when the machine is ON. TURN IT OFF BY PULLING THE PLUG OFF THE SOCKET DURING MAINTENANCE.

IMPORTANT

Always remove the plug from the power point in any case of emergency.

4.7 Advices

Electrical or mechanical maintenance has to be undertaken by qualified personnel.

Person in charge has to be sure that the machine is under TOTAL SAFETY conditions when working.

5 Analysis and Problems Solving

5.1 Problems, causes and solutions

The Potato Peelers were designed to operate with minimum maintenance. However, some irregularities may occur during its operation, due to the natural wear out caused by the equipment use.

If there is any problem with your machine, check the Table-02 bellow, where you will find some possible solutions.

4.2.1 Danger

An electric cable or electric wire with damaged jacket or bad insulation could cause electrical shocks as well as electrical leak. Before using the equipment, check conditions of all wires and cables.

4.2.2 Advices

Be sure ALL INSTRUCTIONS in this manual have been thoroughly understood. Every function and operational procedure has to be very clear to the operator.

Any manual command (switch, button or lever) shall be given only after being sure it is the correct one.

4.2.3 Precautions

The electric cable has to be compatible with the power required by the machine.

Cables touching the floor or close to the machine, need to be protected against short circuits.

4.3 Routine Inspection

4.3.1 Advice

When checking the tension of the belts or chains, DO NOT introduce your fingers between the belts and the pulleys and nor between the chain and the gears.

4.3.2 Precautions

Check the motor and turning or sliding parts of the machine, in case of abnormal noises.

Check the tension of the belts and chains and replace the set when belt, chain or gears show signs of being worn out.

When checking tension of belts or chain, DO NOT introduce your fingers between belts and pulleys, nor between the chains and gears.

Check protections and safety devices to make sure they are working properly.

4.4 Operation

4.4.1 Warning

Do not operate the machine with long hair, which might touch any part of the machine, because it may lead to serious accidents. Tie your hair up well and/or cover your hair with a scarf.

Only trained or skilled personnel shall operate this machine. NEVER operate machine without all original safety devices in perfect condition.

3.2 Cleaning

To make the proper cleaning of the machine, follow the instructions below:

- 1 – Remove the internal lining N°01 (Pic.05) lifting it upwards. Clean this part with plenty of water;
- 2 – Turn the empty machine on, and let it work for a few minutes, adding plenty of water;
- 3 – Switch OFF the machine and unplug it, then wait until the Abrasive Disc N°01 (Pic.07) is motionless;
- 4 – Rub the external part of the machine with a wet cloth;
- 5 – Remove the abrasive disc N°01 (Pic.07) lifting it vertically ;
- 6 – Use a brush with nylon bristles and plenty of water to clean the disc.
- 7 - Replace the internal lining, minding the lock attachment N°01 (Pic.06)
- 8 – Replace the disc on the machine proceeding inversely. Make sure the disc fits properly to the pin of the central shaft.

Pic.05

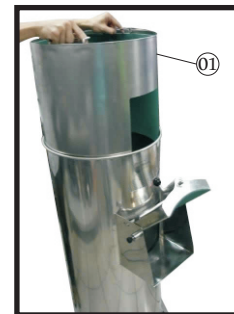

Pic.06

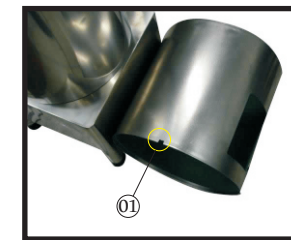

Pic.07



IMPORTANT
Never use water jet to wash the machine.

IMPORTANT
Take care of your machine and use it properly and with responsibility.
It will bring you benefits.

3.3.2 Cautions with Stainless Steel:

The Stainless Steel may present rust signs, which ARE ALWAYS CAUSED BY EXTERNAL AGENTS, especially when the cleaning or sanitization is not constant and appropriate.

The Stainless Steel resistance towards corrosion is mainly due to the presence of chrome, which in contact with oxygen allows the formation of a very thin protective coat. This protective coat is formed through the whole surface of the steel, blocking the action of external corrosive agents.

When the protective coat is broken, the corrosion process begins, being possible to avoid it by means of constant and adequate cleaning.

Cleaning must always be done immediately after using the equipment. For such end, use water, neutral soap or detergent, and clean the equipment with a soft cloth or a nylon sponge. Then rinse it with plain running water, and dry immediately with a soft cloth, this way avoiding humidity on surfaces and especially on gaps.

The rinsing and drying processes are extremely important to prevent stains and corrosion from arising.

IMPORTANT

Acid solutions, salty solutions, disinfectants and some sterilizing solutions (hypochlorites, tetravalent ammonia salts, iodine compounds, nitric acid and others), must be AVOIDED, once it cannot remain for long in contact with the stainless steel:

These substances attack the stainless steel due to the CHLORINE on its composition, causing corrosion spots (pitting).

Even detergents used in domestic cleaning must not remain in contact with the stainless steel longer than the necessary, being mandatory to remove it with plain water and then dry the surface completely.

Use of abrasives:

Sponges or steel wool and carbon steel brushes, besides scratching the surface and compromising the stainless steel protection, leave particles that rust and react contaminating the stainless steel. That is why such products must not be used for cleaning and sanitization. Scrapings made with sharp instruments or similar must also be avoided.

Main substances that cause stainless steel corrosion:

Dust, grease, acid solutions such as vinegar, fruit juices, etc., saltern solutions (brine), blood, detergents (except for the neutral ones), common steel particles, residue of sponges or common steel wool, and also other abrasives.

4. General Safety Practices

IMPORTANT

If any item from the GENERAL SAFETY NOTIONS section is not applicable to your product, please disregard it.

The following safety instructions are addressed to both the operator of the machine as well as the person in charge of maintenance.

The machine has to be delivered only in perfect conditions of use by the Distributor to the user. The user shall operate the machine only after being well acquainted with the safety procedures, and after reading carefully the entire manual.

4.1 Basic Operation Practices

4.1.1 Dangers

Some areas of the electric device have parts and terminals that are connected to high voltage. These parts when touched may cause severe electrical shocks or even be lethal.

Never touch manual commands such as switches, buttons, keys and knobs with wet hands, wet clothes and/or wet shoes. By not following these instructions, operator could be exposed to severe electrical shocks or even to a fatal situation

4.1.2 Warnings

The operator has to be well familiar with the position of ON/OFF Switch to make sure the Switch is easy to be used when necessary.

Before any kind of maintenance, physically remove the plug from its socket.

Provide space for a comfortable operation thus avoiding accidents.

Water or oil spilled on the floor will turn it slippery and dangerous. Make sure the floor is clean and dry.

Never use a manual command (switch, buttons, lever) unadvisedly.

If any work is to be made by two or more persons, coordination signs will have to be given for each operation step. Every step of the operation shall be taken only if a sign has been made and responded.

4.1.3 Advices

In case of power shortage, immediately turn the machine OFF.

Use recommended or equivalent lubricants, oils or greases.

Avoid mechanical shocks as they may cause failures or malfunction.

Avoid penetration of water, dirt or dust into mechanical or electrical components of the machine.

DO NOT MODIFY original characteristics of the machine.

DO NOT REMOVE, TEAR OFF OR MACULATE any safety or identification labels of the machine. If any label has been removed or is no longer legible, contact your nearest dealer for replacement.

4.2 Safety Procedures and Notes before Switching Machine ON

IMPORTANT

Carefully read ALL INSTRUCTIONS of this manual before turning the machine ON. Be sure to be familiar with the instructions and that you have well understood all information contained in this manual. If you have any question, contact your supervisor or your nearest Dealer.