

PROFESSIONAL

Model CDR631 User Guide

Compact Disc Recorder

marantz®

CLASS 1 LASER PRODUCT
LUOKAN 1 LASERLAITE
KLASS 1 LASERAPPARAT

COMPACT
disc
Recordable
ReWritable

ENGLISH

WARRANTY

Contact your local Marantz distributors for warranty information.

RETAIN YOUR RECEIPT AS PROOF OF PURCHASE

Your receipt is proof of a valuable purchase. Keep it in a safe place where you can easily find it for filing insurance claims when necessary or when corresponding with Marantz.

IMPORTANT

It is the responsibility of the consumer to establish proof of purchase when seeking servicing covered by the warranty. Your receipt or invoice is valid as such proof.

U.K. ONLY

This undertaking is in addition to a consumer's statutory rights and does not affect those rights in any way.

FRANÇAIS

GARANTIE

Veuillez contacter les revendeurs Marantz locaux pour de plus amples informations concernant la garantie.

CONSERVER LE TICKET DE CAISSE COMME PREUVE D'ACHAT

Le ticket de caisse représente la preuve d'un achat de valeur. Le conserver dans un endroit sûr, où il peut être retrouvé aisément, afin d'introduire les revendications éventuelles auprès des assurances ou auprès de Marantz, le cas échéant.

IMPORTANT

Il incombe au consommateur d'établir la preuve de son achat, à l'aide du ticket de caisse ou de la facture, lors de la demande d'interventions couvertes par la garantie.

DEUTSCH

GARANTIE

Wenden Sie sich bezüglich Informationen zur Garantie an Ihren örtlichen Marantz-Händler.

BEWAHREN SIE ALS KAUFNACHWEIS IHRE KAUFQUITTUNG AUF

Ihre Quittung bzw. Rechnung ist ein Beweis für Ihren wertvollen Kauf. Bewahren Sie diese an einem sicheren Ort auf, wo Sie sie im Fall eines Versicherungsschadens oder bei der Korrespondenz mit Marantz leicht wiederfinden können.

WICHTIG

Es liegt in der Verantwortung des Käufers, den Kaufnachweis zu liefern, wenn Garantiereparaturen in Anspruch genommen werden sollen. Ihre Quittung oder Rechnung dient als ein solcher Nachweis.

NEDERLANDS

GARANTIE

Neem contact op met de Marantz distributeurs in uw buurt voor informatie over de garantie.

BEWAAR UW REÇU ALS AANKOOPBEWIJS.

Uw reçu is het bewijs dat u een waardevol product heeft gekocht. Berg het veilig op, zodat u het snel terug kunt vinden als u een verzekeringsclaim moet indienen of voor uw correspondentie met Marantz.

BELANGRIJK

De klant is verantwoordelijk voor het tonen van een aankoopbewijs wanneer het apparaat onder garantie moet worden gerepareerd. Uw reçu of uw factuur is een geldig aankoopbewijs.

ESPAÑOL

GARANTÍA

Consulte a su distribuidor local de Marantz si desea más información sobre la garantía.

CONSERVE EL RECIBO COMO PRUEBA DE COMPRA

Su recibo constituye la prueba de compra. Guárdelo en un lugar seguro donde pueda hallarlo fácilmente en caso de que lo necesite para presentar una reclamación de garantía o mantener algún tipo de correspondencia con Marantz.

IMPORTANTE

Es responsabilidad del consumidor presentar la prueba de compra siempre que solicite alguna reparación cubierta por la garantía. La factura o el recibo son documentos válidos como prueba de compra.

ITALIANO

GARANZIA

Contattare i distributori Marantz della zona dell'utente per informazioni sulla garanzia.

CONSERVARE LA RICEVUTA COME PROVA D'ACQUISTO

La ricevuta comprova un acquisto di valore. Conservarla in un luogo sicuro e facilmente reperibile per intraprendere dei reclami, ove necessario, o quando ci si rivolga alla Marantz.

IMPORTANTE

L'utente ha la responsabilità di produrre una prova d'acquisto se vuole servirsi dell'assistenza coperta da garanzia. La ricevuta o la fattura è valida in questo senso.

PORTUGUÊS

GARANTIA

Para informações sobre a garantia, contacte o concessionário local Marantz.

GUARDE O TALÃO DE COMPRA COMO PROVA

O talão de compra é a prova de ter comprado qualquer coisa de valor. Guarde-o em lugar seguro, pois pode precisar dele para obter uma cobertura de seguro ou no âmbito de correspondência com Marantz.

IMPORTANTE

Para obter um serviço coberto pela garantia, o cliente deve apresentar a prova e a data da compra. O talão ou a factura constituem provas suficientes.

SVENSKA

GARANTI

Kontakta din lokala Marantz-distributör för information om garantin.

SPAR KVITTOT SOM INKÖPSBEVIS

Kvittot är ditt bevis för ett värdefullt inköp. Förvara det på en säker plats där du lätt kan hitta det för försäkringsfrågor eller korrespondens med Marantz.

VIKTIGT

Kunden ansvarar för att uppvisa inköpsbevis när service begärs som täcks av garantin. Ditt kvitto eller faktura är ett giltigt inköpsbevis.

CE MARKING

- CE English**
The unit is in conforms with the EMC directive and low-voltage directive.
- CE Français**
Cet appareil est conforme à la directive EMC et à la directive sur les basses tensions.
- CE Deutsch**
Dieses Greät entspricht den EMC-Richtlinien und den Richtlinien für Niederspannungsgeräte.
- CE Nederlands**
Dit apparaat voldoet aan de EMC-richtlijn en de richtlijn voor apparatuur met laag voltage.
- CE Español**
Esta unidad estáde acuerdo con las EMC y las relacionadas con baja tensión.
- CE Italiano**
Quest' unità è conforme alle direttiva EMC ed alla direttiva sulle basse tensioni.
- CE Português**
Esta unidade está em conformidade com as directivas EMC e as directivas de baixa voltagem.
- CE Svenska**
Denna enhet överensstämmer med EMC direktivet och direktivet för lågspänning.

SI DICHIARA CHE L'APPARECCHIO SINTO-AMPLIFICATORE SR-39 RISPONDE ALLE
PRESCRIZIONI DELL' ART.2 COMMA 1 DEL D.M. 28 AGOSTO 1995 N° 548.

FATTO A EINDHOVEN, IL 1/1/1977

MARANTZ EUROPE B.V.
5600 EINDHOVEN
THE NETHERLANDS

Este aparato lleva elementos antiparasitarios necesarios para cumplir con los limites que se
establereen en el Anexo V del Reglamento sobre Perturbaciones Radioelectricas e
Interferencias aprobado en el Real Decreto 138/1989. (B.O.E. de 9 de Febrero 1989)

WARNINGS FOR LASER RADIATION

CAUTION: INVISIBLE LASER RADIATION WHEN OPEN. DO NOT STARE INTO BEAM.

DANGER: INVISIBLE LASER RADIATION WHEN OPEN. AVOID DIRECT EXPOSURE TO BEAM.

VARO!: AVATTAESSA JA SUOJALUKITUS OHITETTAESSA OLET ALTTIINANAKYMÄTTÖMÄALLE
LASERSÄTEILYLLE. ÄLÄ KATSO SÄTEESEEN.

VARNING!: OSYNLIG LASERSTÅLNING NÄR DENNA DEL ÄR ÖPPNAD OCH SPÄRREN ÄR
URKOPPLAD. BETRAKTA EJ STRALEN.

INTRODUCTION

Foreword

This section must be read carefully before any connection is made to the mains supply.

WARNINGS

- Do not expose the equipment to rain or moisture.
- Do not remove the cover from the equipment.
- Do not insert anything into the equipment through the ventilation holes.
- Do not handle the mains lead with wet hands.

CE marking (only EU version)

CE This product is in conformity with the EMC directive and low-voltage directive.

Equipment mains working system

Your Marantz product complies with the household power and safety requirements in your area.

“N1” Version product can be powered by 230 V AC only.

IMPORTANT: (FOR U.K. version only)

This apparatus is fitted with an approved moulded 13 Amp plug. To change a fuse in this type of plug proceed as follows:

1. Remove fuse cover and fuse.
2. Fix new fuse which should be a BS1362 5A, A.S.T.A. or BSI approved type.
3. Refit the fuse cover.

If the fitted plug is not suitable for your socket outlets, it should be cut off and an appropriate plug fitted in its place.

If the mains plug contains a fuse, this should have a value of 5A. If a plug without a fuse is used, the fuse at the distribution board should not be greater than 5A.

Note:

The severed plug must be destroyed to avoid a possible shock hazard should it be inserted into a 13A socket elsewhere.

HOW TO CONNECT A PLUG

The wires in this mains lead are coloured in accordance with the following core:

GREEN—and—YELLOW—“EARTH” (“E”)

BLUE—“NEUTRAL” (“N”)

BROWN—“LIVE” (“L”)

As the colours of the wires in the mains lead of this apparatus may not correspond with the coloured markings identifying the terminals in your plug, proceed as follows:

1. The wire which is coloured green-and yellow must be connected to the terminal in the plug which is marked with the letter “E” or by the earth symbol \perp or coloured green or green-and-yellow.
2. The wire which is coloured blue must be connected to the terminal which is marked with the letter “N” or coloured BLACK.
3. The wire which is coloured brown must be connected to the terminal which is marked with the letter “L” or coloured RED.

Before replacing the plug cover, make certain that the cord grip is clamped over the sheath of the lead — not simply over the three wires.

Copyright

Recording and playback of some material may require permission. For further information refer to the following:

- Copyright Act 1956
- Dramatic and Musical Performers Act 1958
- Performers Protection Acts 1963 and 1972
- Any subsequent statutory enactments and orders

Congratulations on the acquisition of your CD-Recorder. This CD-Recorder now enables you to record, play and erase your own audio Compact Discs. Naturally the recorder can also be used to play all pre-recorded CDs.

With the exception of legal restrictions pertaining to copying, you can now create your own high-quality audio recordings on CD. The discs used to record must bear the logos shown below.

There are two types of recordable AUDIO discs:

CD-R(W) discs have a compatibility to play/record on the CD-Recorders based on the ORENGE BOOK Part II/III. But the discs might not be able to be played/recorded properly depending on the combinations of the discs and CD-Recorders.

- 1 CD Recordable Disc (record once):

Fully recorded and subsequently finalized CD-R discs can be played on CD players and recorders that are suitable for CD-R discs. CD-R discs can be recognized by the following logos:



- 2 CD ReWritable Disc (multiple recording):

Recorded and finalized CD-RW discs can be played on all CD players and recorders that are suitable for CD-RW discs. CD-RW discs can be recognized by the following logos:



Once you start using the recorder, you will discover how easy it is to ‘make’ your own CDs. Nevertheless, we recommend that you use an erasable (CD-RW) digital audio disc on your first attempt, while following the instructions given here.

Attention!

Recordings may only be made for personal use.

It is forbidden to copy material protected by copyright, including computer programs, films, television and audio recordings. This appliance may not be used for applications of this type.

Note:

Some CD players can not play the finalized CD-R(W) discs because of the low reflectivity of such discs.

Because of laser power differences, some DVD players cannot play the finalized CD-R(W) discs.

Read the text carefully and keep the instructions close at hand so that you can refer to them if necessary.

INTRODUCTION

Unpacking

First check the contents of the packaging. It should contain the following:

- CD-Recorder CDR631
- Remote control with batteries packaged separately
- Power cord
- Remote control cable (with orange plugs)
- Instructions

If one of these components is missing, please inform your supplier immediately. Save the packaging material it may come in handy if you move the appliance.

Setup

- Place the recorder on a strong, vibration-free surface.
- Do not use the recorder under extremely damp conditions.
- If the recorder is placed in a cabinet, make sure that a 2.5 cm space remains free on all sides of the recorder for proper ventilation.

Attention!

If the appliance is not used or operated in accordance with the instructions, this may result in exposure to dangerous radiation or other risks.

Only authorized technicians are allowed to open the appliance casing or to perform repairs or maintenance.

Compact discs

The glossy side shining like a rainbow is the front side of the disc, and the side on which the label is printed is the back. Unlike conventional turntables for playing analog discs, the CDR631 reads the information recorded on the disc from underneath without contacting it using a beam of laser light. Therefore, the performance of a compact disc will not degrade like conventional analog records.

Handle discs carefully so as not to damage or scratch the front side.

To protect the disc, avoid placing it in the following locations:

- In direct sunlight or near a source of heat like a heater.
- In a place which is damp or dirty.
- In a place which could be exposed to rain, such as near a window.

Always keep the disc surface clean.

Up to six billion data units are recorded on the front side of the disc. When cleaning the disc surface, always be sure to use a special compact disc cleaner and wipe as shown below.

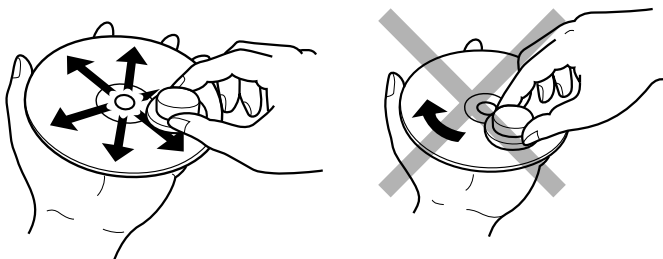

Wipe in a radial direction. Do not wipe in circumferential direction.

- Do not use conventional record cleaner for analog records, as this will adversely affect the disc surface. Store discs properly by placing them in their disc cases.
- Do not attach a piece of paper or sticker on the label side of disc. When a disc has a piece of plastic tape or rental CD label with paste protruded from the edge or when a disc has a trace of such a sticky object, do not attempt to play the disc. If such a disc is played on the CD player, impossibility of taking out the disc or other malfunction may result.

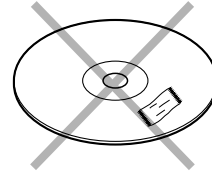

- Write only on the printed side of a CD-R or CD-RW, and only with a soft felt-tipped pen.
- Do not use a disc with a special shape. Do not attempt to play a disc with a special shape such as a heart-shaped disc or octagonal disc. Otherwise the equipment malfunction may result.

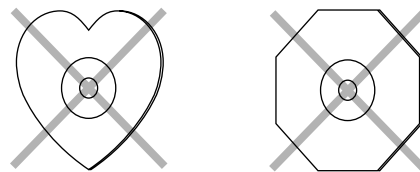

Maintenance

Clean the CD-Recorder with a soft, slightly dampened lint-free cloth. Do not use any cleaning agents as they may have a corrosive effect.



Do not expose the CD-Recorder, batteries or CDs to humidity, rain, sand or excessive heat (caused by heating equipment or direct sunlight).

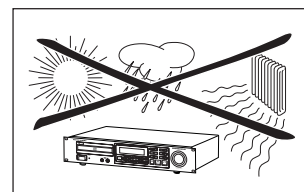

If the CD-Recorder cannot read CDs correctly use a commonly available cleaning CD to clean the lens before taking the CD player to be repaired. Other cleaning methods may destroy the lens. Always keep the tray closed to avoid dust on the lens.

The lenses may cloud over when the CD-Recorder is suddenly moved from cold to warm surroundings. It is not possible to play a CD then. Leave the CD-Recorder in a warm environment until the moisture evaporates.

CONTROLS AND CONNECTIONS

Controls on the front

- (1) **POWER** turns the CD-Recorder ON and OFF
- (2) **STANDBY indicator**
- (3) **Disc tray** records CD-R(W) and plays CD and CD-R(W)
- (4) **HEADPHONE** socket for headphones
- (5) **LEVEL** adjust the headphone volume
- (6) **▲** opens/closes disc tray
- (7) **TIME** selects display information/text
- (8) **TEXT** activate scrolling of text over the display (once)
- (9) **Number keys 0 - 9** selects a track by number
- (10) **INPUT** selects external input source
- (11) **PROG** opens/closes program memory
- (12) **●** starts recording, finalizing, erasing
- (13) **■** stops/clears a program
- (14) **▶/||** starts play/interrupts play or recording
- (15) **◀◀** previous track (Play and Program mode)
- (16) **▶▶** next track (Play and Program mode)
- (17) **◀◀** - searches backward
- cursor control in Menu/Prog. review mode
- (18) **▶▶** - searches forward
- cursor control in Menu/Prog. review mode
- (19) **REC LEVEL/SELECT** - previous/next track (Play and Program mode)
- recording level control (recording)
- selects settings (menu on)
- PUSH ENTER** - plays selected tracks
- (push)** - selects settings in Menu mode
- programs track numbers
- (20) **STORE/MENU** - enters Menu mode
- stores Menu settings
- (21) **REPEAT** repeat play(All, program or track)
- (22) **RANDOM** plays CD-R(W) or program in random order
- (23) **DELETE/CANCEL** - deletes tracks from a program
- deletes text in Menu mode
- returns to a higher level in the menu
- (24) **ERASE** selects erasing mode
- (25) **TRACK INCR. (ement)** increases track numbers during recording
- (26) **REC MODE** selects recording modes
- (27) **FINAL** selects finalize mode General
- (28) **Display** information screen
- (29) **IR sensor** receives signals from the remote control.

Note:

- When provided on the remote control, you can also use the corresponding buttons.
- Some buttons are only on the remote control.

Connections at the back

- (30) **TRIM** adjust the coming input level
- (31) **INPUT SELECT** selects the input BALANCED IN or ANALOG IN
- (32) **ANALOG IN** connects to the line output of an amplifier (left and right)
- (33) **ANALOG OUT** connects to the line input of an amplifier (left and right)

- (34) **AES/EBU-SPDIF switch** ... selects AES/EBU or SPDIF connection
- (35) **DIGITAL (SPDIF) IN** connects to the digital coaxial output of an external CD player
- (36) **DIGITAL (SPDIF) OUT** connects to the digital coaxial input of e.g. amplifier or recording device
- (37) **DIGITAL (SPDIF) LOOP OUT** connects to the digital coaxial input of e.g. amplifier or recording device
- (38) **DIGITAL (SPDIF) OPT INPUT** connects to the digital optical output of an external CD player
- (39) **REMOTE CONTROL SWITCH**
- (40) **REMOTE CONTROL OUT** connects to a remote control input on the Marantz amplifier
- (41) **REMOTE CONTROL IN** connects to a remote control output on the Marantz amplifier
- (42) **Connection to mains**
- (43) **DIGITAL (AES/EBU) BALANCED IN** connects to the digital balanced output of amplifier
- (44) **BALANCED IN** connects to the balanced output of amplifier (left and right)

DISPLAY indications

- (45) **REM/REC TIME** remaining recording time / recording time
- (46) **TRACK** track number
- (47) **▼** balance (lights during balance adjustment)
- (48) **TOTAL REM TRACK TIME** total or remaining time of disc or track
- (49) **STEP** indicates the number of tracks in a program
- (50) **20 +** disc or program contains more than 20 tracks
- (51) **Track Number** tracks on a discs or in a program track in play
- (52) **PROGRAM** flashes during programming/lights in program mode
- (53) **RANDOM ALL** plays tracks in random order
- (54) **SCAN** lights up when the first 10 seconds of each track are played.
- (55) **REPEAT TRACK/ALL** ... lights up when a track/ complete disc (or program) is repeated.
- (56) **L/R** record/play level bar. Indicates the audio signal level.
- (57) **▶** lights during play
- (58) **R (W)** unfinalized CD-R(W) disc inserted
- (59) **●** lights during recording
- (60) **||** pause function active
- (61) **OPT I→** optical input I selected for external recording
- (62) **ANALOG ↗→** analog input selected for external recording
- ANALOG** analog recording
- (63) **MANUAL** manual start of external recording
- (64) **SYNC** automatic or synchronized start of external recording
- (65) **DIG I ↗→** digital input I selected for external recording

REMOTE CONTROL

Remote control commands

- (66) **STANDBY**  switches to Standby On/Off
- (67) **TRACK INCR. (ement)** .. increases track numbers during recording
- (68) **SCAN** plays the first 10 seconds of each track
- (69) **REPEAT** repeat play(All, program or track)
- (70) **Number/alphabet keys 0 - 9** .. - selects a track by number
- selects character for text input
- (71) **DISPLAY** selects display information/text
- (72) **CDR** selects CD-Recorder
- (73) **▶** starts CD-R(W) play
- (74) **◀◀** previous track (Play and Program mode)
- (75) **◀◀** - searches backward
- cursor control in Menu/Prog. review mode
- (76) **||** interrupts CD-R(W) play/recording
- (77) **MENU/STORE** - enters Menu mode
- stores Menu settings
- (78) **ENTER** - selects settings in Menu mode
- programs track numbers
- starts playback of selected track
- (79) **CANCEL/DELETE** - deletes tracks from a program
- deletes text in Menu mode
- returns to a higher level in the menu
- (80) **▶▶** - searches forward
- cursor control in Menu/Prog. review mode
- (81) **■** stops CD-R(W) and clears a program
- (82) **▶▶|** next track (Play and Program mode)
- (83) **CD** selects CD player
- (84) **SCROLL** activates scrolling of text over the display
- (85) **PROG. (ram)** opens/closes program memory
- (86) **RANDOM** plays CD-R(W) or program in random order

INSTALLATION

The numbers between parentheses refer to the fold-out.

This CD-Recorder can be used to record directly or through a (pre-) amplifier from any digital or analog audio source. In addition, the appliance can be used as a regular CD player. Read how to connect the CD-Recorder based on the possibilities your other audio equipment offers. Please refer to the operating instructions for your other audio equipment first.

The following options are available:

- Balanced analog connections
- Unbalanced analog connections
- Digital AES/EBU connections
- Digital SPDIF connections
- Digital Optical connections
- Digital cascade connections

Balanced analog connections

1 For recording, connect the analog balanced cable from the CD-Recorder to a source based on the diagram below:

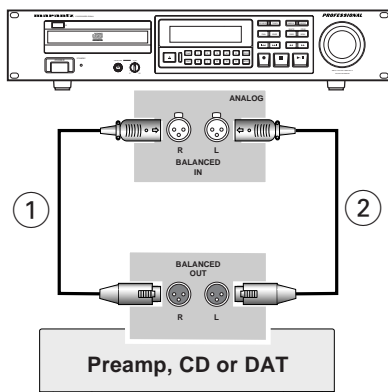

2 Select **INPUT SELECT** switch (31) to **BALANCED IN**.

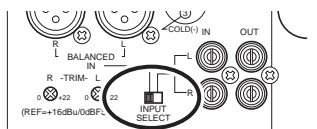

When this CD-Recorder is shipped, it is already set to +16dBu/0dBFS at the MAX-REC-LEVEL. If you want to change the level, rotate **TRIM** control (30) to adjust input level for both L and R.

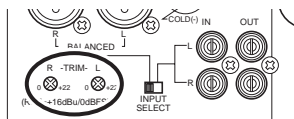

Unbalanced analog connections

1 For recording and playing, connect the CD-Recorder to preamp or another equipment based on the diagram below:

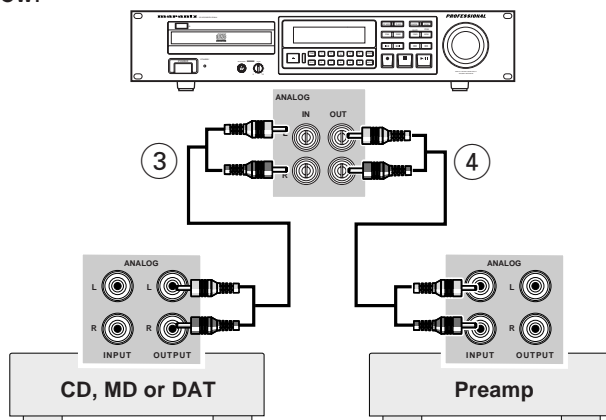

2 Select **INPUT SELECT** switch (31) to **ANALOG L/R** (RCA).

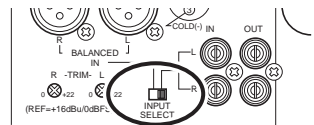

Note:

Never use the PHONO input.

Digital AES/EBU connections

1 For recording, connect the balanced cable from the CD-Recorder to a source based on the diagram below:

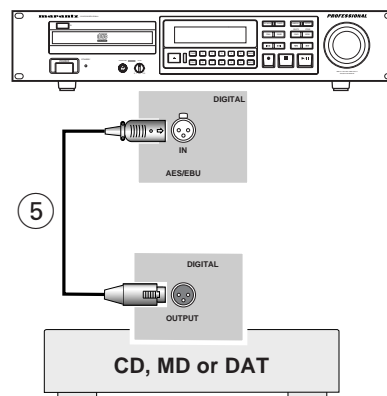

2 Select **AES/EBU SPDIF** switch (34) to **AES/EBU**.

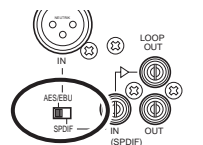

INSTALLATION

Digital SPDIF connections

- 1 For recording and playing, connect the coaxial cables from the CD-Recorder to a digital equipment based on the diagram below:

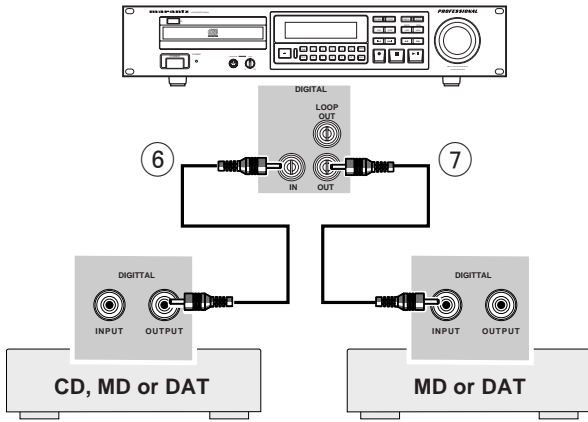

- 2 AES/EBU-SPDIF switch (34) selects SPDIF.

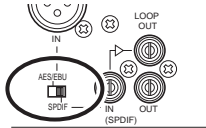

Note:

You can also connect the LOOP OUT socket on this CD-Recorder to the input sockets of a CD or DAT when DIGITAL (SPDIF) IN is used.

Digital Optical connections

- 1 For recording and playing, connect the fiber-optic cable from the CD-Recorder to a digital equipment based on the diagram below.

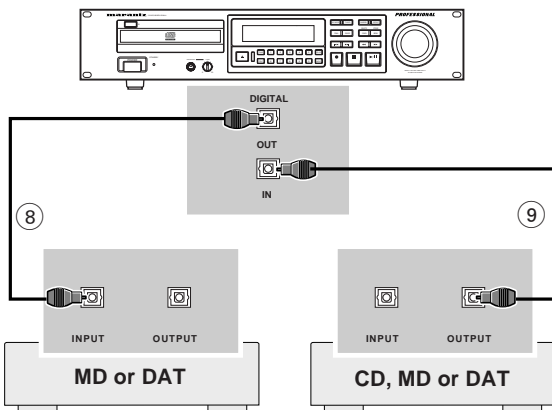

Note:

Before connection the cables, remove the dust caps from the digital optical connections. We recommend that you save the caps.

Digital cascade connections

- 1 For cascade recording, connect a CD player from the digital out socket to CDR DIGITAL IN socket on the CDR631 recorder using cable 9.
- 2 Connect the CDR631 recorder from CDR DIGITAL LOOP OUT socket to CDR DIGITAL IN socket on another CDR631 recorder using cable 10.
- 3 Connect the CDR631 recorder using the cable 11 in the same way. Cascade connections of this CD-Recorder are possible up to 5 stages.

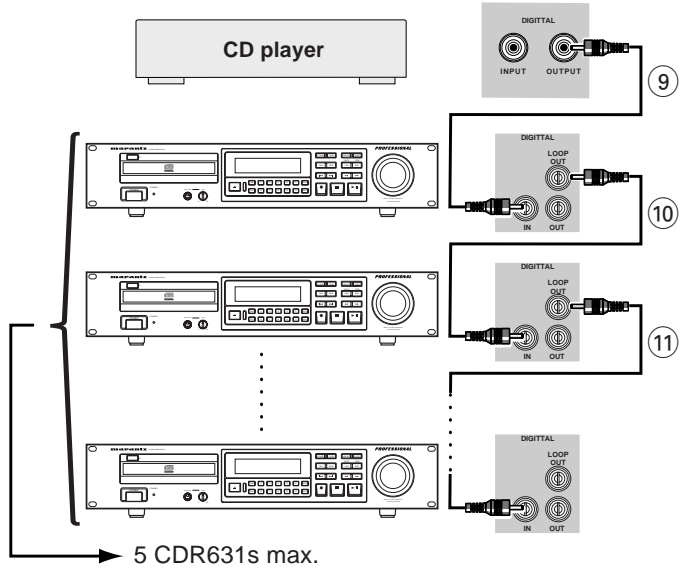

Note:

Cascade connection is useful when you make a several copies from an original source since the being the recording signal is directly go through LOOP OUT from INPUT on this CD-Recorder. Cascade connections of this CD-Recorder are possible up to 5 stages.

D-BUS CONNECTION

The numbers between parentheses refer to the fold-out.

Remote control cable connections

By connecting CDR631 to the Marantz amplifier using a D-BUS remote control cable ⑫, you can operate the operations of CDR631 from the remote control of the amplifier. **Set the remote control selector to 'EXTERNAL'.**

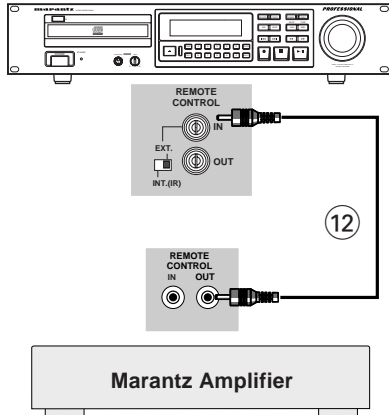

Note:

When you don't use the D-BUS connection, ALWAYS set the remote control selector to 'INTERNAL'.

USING THE RECORDER

The numbers between parentheses refer to the fold-out.

Switching ON and OFF

- 1 Plug the power cord supplied into the MAINS connector on the CD-Recorder, then into a mains socket.

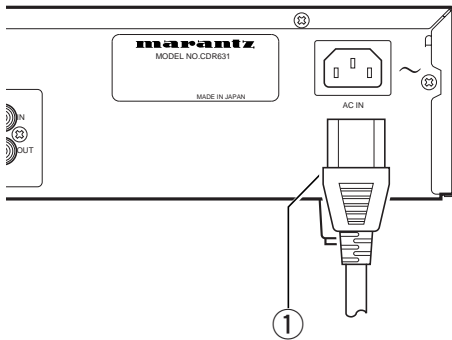

- 2 Press the POWER (1) button on the front of the CD-Recorder to turn it on or off.

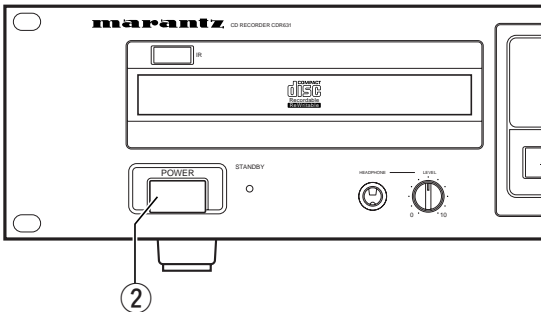

Using the remote control

- 1 Open the battery compartment cover.
- 2 Insert 2 batteries (AA, LR-6 or UM-3; as supplied) as shown.
- 3 Replace the cover.

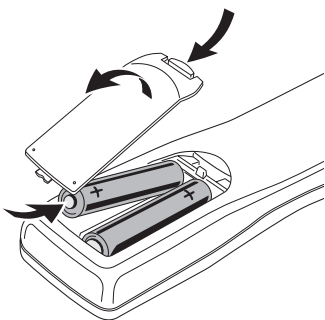

Note:

- We recommend you use 2 batteries of the same type and condition.
- Always point the remote control directly towards the recorder and make sure there.

This remote control can switch "STANDBY ON/OFF" but cannot switch "POWER ON/OFF" the CD-Recorder.

Batteries contain chemical substances, so they should be disposed of properly.

Inserting discs

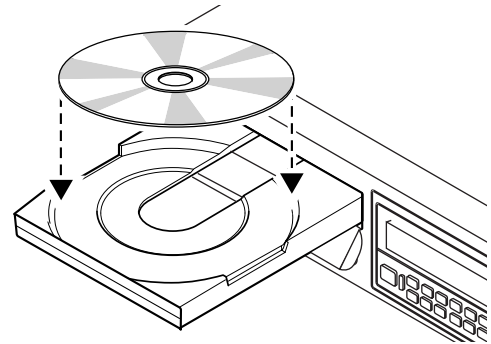

- 1 Press ▲ (6) to open the disc tray. → OPEN lights up.
- 2 Insert a CD, CD-R or CD-RW in the appropriate recess in the tray, label side up.
- 3 Press ▲ (6) to close the tray. → CLOSE lights up, followed by PENDING and the display will show the type of disc you inserted.

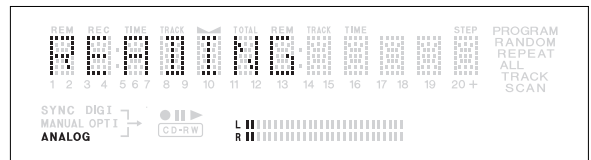

- If a CD-R(W) is finalized it will show CD on the display.
- If CD-text is available the TITLE/ARTIST will scroll by.

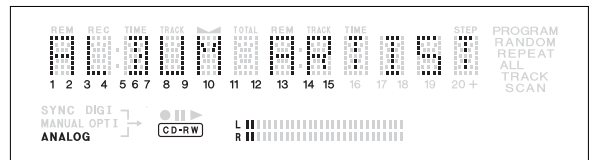

Note:

- For recording it is important that the blank disc is completely free from dust particles or scratches. (see Compact Discs page 2).
- If you insert a blank or partly-recorded CD-R(W) or unfinalized CD-R(W), the CD-Recorder will calibrate the disc for optimum recording. During this process the display will first show INITIALIZING and then the number of audio tracks. Calibration can take up to 30 seconds.

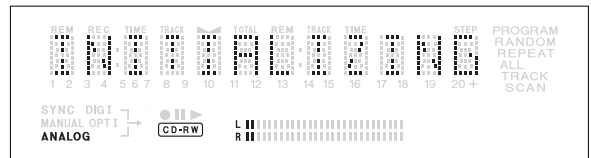

RECORDING

The numbers between parentheses refer to the fold-out.

Remarks about recording

You will soon discover how easy it is to make your own CDs. Nevertheless, it is advisable to use a CD-RW disc for your first try.

- **If the disc is a CD-RW and is already finalized you must unfinalize it first.**
- The recording procedure is the same for CD-Rs and CD-RWs.
- If the disc already contains recordings, the CD-Recorder will automatically search for the end of the last track, so that recording can start from there.
- **There must be at least 7 seconds of recording time left on the disc**, otherwise you will not be able to enter record standby mode. **DOES NOT FIT** then lights up.
- A maximum of 99 tracks can be recorded on a disc. Minimum allowable track length is 4 seconds.
- Recordings from DAT or DCC players will not always stop automatically.
- SRS (Sample Rate Conversion)
This CD-Recorder can perform Sample Rate Conversion on the incoming signal, it is capable of handling sources, hating from 12 kHz up to 56 kHz.
If non 44.1 kHz (± 100 PPM) source was connected, this CD-Recorder will automatically switch to SRC function.

Important:

If you want to play the recorded CD-R disc on any regular CD player, it must first be finalized. (See FINALIZING/UNFINALIZING.)

Finalized CD-RW discs play only on CD-RW compatible CD players.

Recording from CD-changers should always be started in the RECORD DISC, RECORD TRACK or MAKE CD mode.

Recording modes

Your recorder offers several recording modes.

- **RECORD DISC** - to make a synchronised recording of the complete disc or a program simply by starting the source.
- **RECORD TRACK** - to make a synchronised recording of a single track simply by starting the source.
- **REC MANUAL** - to manually start a recording simply by pressing the ● (RECORD) key.
- **MAKE CD** - to make a synchronised recording of the complete disc or a program simply by starting the source. Finalizing will be done automatically.

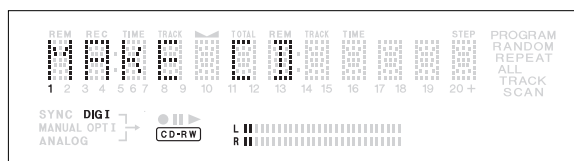

Some remarks on recording:

- When **Auto track is on** (default setting), **track numbers will automatically be increased during recording.**
- By programming tracks first, a compilation can be recorded.
- If a finalized CD recordable disc is inserted in the CD-Recorder, **FINALIZED CD** will be displayed. **Recording is not possible.**
- If a finalized CD rewritable disc is inserted in the CD-Recorder, **UNFINALIZE** and **PRESS ENTER** will be displayed when the **REC MODE** (26) is pressed. If **PUSH ENTER** (19) is pressed, the disc will be unfinalized.
- This CD-Recorder can record about 17 seconds of a pause time. If you record a track including more than 17-seconds-pause time by digital recording, the pause time will be recorded the different length of time from original. However, the entire track time will not be changed and be able to listen to the music as same as original.
- When you copy a special disc such as HDCD or DTS, you have to
 - set the sampling frequency at 44.1kHz.
 - use the digital connection.
 - set the digital rec-volume of the CD-Recorder at 0 dB.
- When you copy the tracks from a DAT recorded by different sampling frequencies, noise might be recorded in the disc. Please set a sampling frequency for every track in a DAT.

Warning:

No more recording possible after finalizing CD-R disc!

RECORDING

The numbers between parentheses refer to the fold-out.

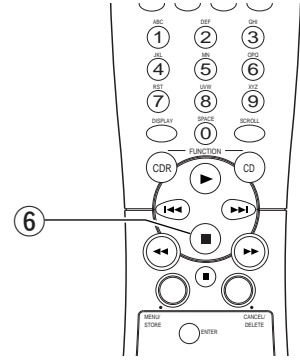
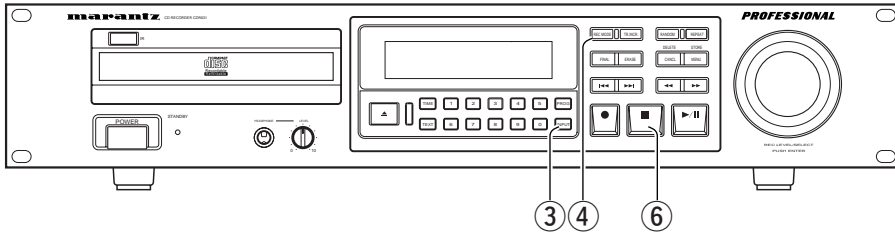

CD-SYNC

The CD-SYNC feature enables you to make fast and easy recordings of a CD. Track increments are automatically detected from the source material. Track increments cannot be added manually. In analog source material a silence of 2.7 seconds or more is automatically detected as a track increment.

- ① Make sure the disc is absolutely free of scratches and dust particles.
- ② Connect the cable from an external CD player to the CD-Recorder. (see INSTALLATION from page 5 to 7.)
- ③ Press **INPUT (10)** repeatedly until the selected source, appears on the display (depending on the digital connection used):
 - ➔ **DIGI**, **OPT I** or **ANALOG** lights up and **DIGITAL I**, **OPTICAL** or **ANALOG** appears on the display.

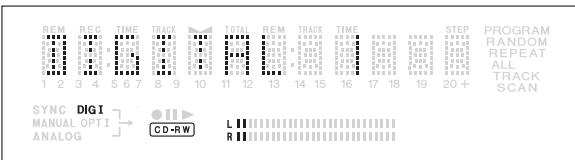

- ④ With the CD-Recorder stopped, press **REC MODE (26)**.
 - once: to select 'RECORD DISC'
 - twice: to select 'RECORD TRACK'
 - four times: to select 'MAKE CD' (When ANALOG was selected, this menu dose not appear on the display.
 ➔ **REC MODE** and **SYNC** start to flash.

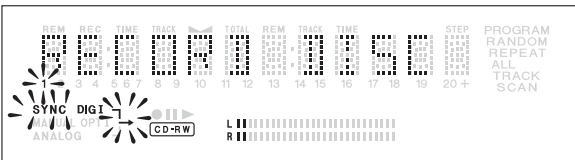

- If **DIGI** or **OPT I** flashes, the digital connection is incorrect.

Note:

You can adjust the recording level by rotating the **REC LEVEL/SELECT (19)**.

DIGITAL RECORDING : +6dB ~ -63dB
 ANALOG RECORDING : 0dB ~ -63dB

- ⑤ To start recording, press **PLAY** on the selected source.
 - ➔ The CD-Recorder automatically starts to record. The recording time left appears on the display.
 - If, however, you start the source during a track, CD-SYNC recording starts at the beginning of the next track or after 2.7 seconds of silence in analog recordings.
 - To check the elapsed recording time, press **TIME (7)** or **DISPLAY (71)**. (This can also be done during recording)
 - The recorder stops automatically.
- ⑥ To stop recording manually, press **STOP (13, 81)**.
 - If **STOP (13, 81)** was pressed within 3 seconds after pressing **PLAY** on the selected source, no recording will take place.
 - To interrupt recording, press **▶/|| (14)** or **|| (76)**. To resume, press **● (12)** on the CD-Recorder.

After recording the display will show **UPDATE** for several seconds.

Note:

- Recordings from DAT, DCC or analog sources will only stop after 20 seconds silence.
- **MAKE CD** is a recording mode for auto finalized after synchronized recording. It takes about 1 minute to start auto finalizing after finish recording the last track. (**WAIT** appears on the display.)
- The recorded sound might be distorted when you adjust the recording level to set above 0dB for digital recording and -12dB for analog recording. The default setting of recvolume for digital is 0dB and analog is -12dB when this CD-Recorder is shipped.

Important:

If you want to play the recorded CD-R disc on any regular CD player, it must first be finalized. See finalizing discs.

Finalized CD-RW discs play only on CD-RW compatible CD players.

RECORDING

The numbers between parentheses refer to the fold-out.

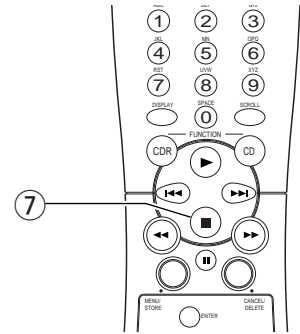
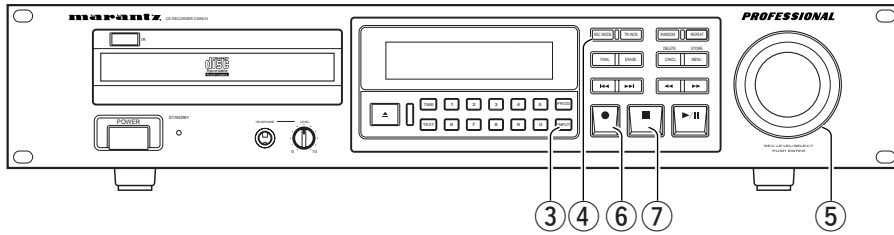

Manual start recording

About AUTO TRACK and AUTO STOP

- AUTO TRACK is a function to increment track numbers either manually or automatically.
 - AUTO TRACK ON** : track number will be automatically incremented according to the source. (See the table on page 19.)
 - AUTO TRACK OFF** : track number can be manually incremented by pressing **TR. INCR.** (25) or **TRACK INCR.** (67).
- When AUTO TRACK is ON, you can also set AUTO STOP function.
 - AUTO STOP ON** : the recording will be stopped automatically. (See the Table on page 20.)
 - AUTO STOP OFF** : the recording has to be stopped manually.

Note:

AUTO STOP function is only activated when Manual start recording (REC MANUAL mode) is used.

- Make sure the disc is absolutely free of scratches and dust particles.
- Connect the cable from an external CD player to the CD-Recorder. (see INSTALLATION page 5 and 6.)
- Press **INPUT** (10) repeatedly until the selected external source appears on the display (depending on the connection used):
 - **DIGI**, **OPT I** or **ANALOG** lights up and **DIGITAL**, **OPTICAL** or **ANALOG** appears on the display.

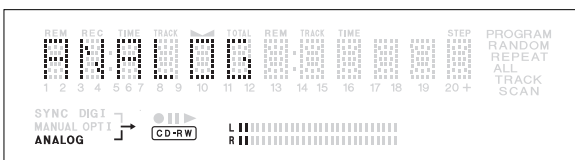

- With the recorder stopped, press **REC MODE** (26) three times to enter the Manual Record standby mode.
 - **MANUAL** starts to flash and the display shows **REC MANUAL**.

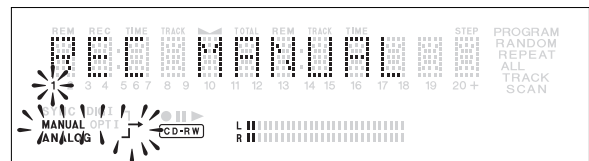

- If **DIG I** or **OPT I** flashes, the digital connection is incorrect.
- Set the optimal recording level on the CD-Recorder.
 - Play the source first to set the optimal recording level on the CD-Recorder.
 - Rotate the **REC LEVEL/SELCT** (19) key until, on the Record/Play Level bar, all the blue segments are alight, but the red segments do not light continuously during the loudest passages.
 - DIGITAL RECORDING : +6dB ~ -63dB
 - ANALOG RECORDING: 0dB ~ -63dB
 - Stop the source.
 - To record a 3-second silence at the start of a track, press **▶/||** (14) or **||** (76) on the CD-Recorder before starting the source.
 - To start recording, press **●** (12) on the CD-Recorder and immediately start the source (from Stop-mode).
 - The track number and recording time left appear on the display.
 - If **■** (13, 81) was pressed within 3 seconds after **●** (12), no recording will take place.
 - To check the elapsed recording time, press **TIME** (7) or **DISPLAY** (71). (This can also be done during the recording.)
 - To stop recording, press **■** (13, 81).
 - To interrupt recording, press **▶/||** (14) or **||** (76).

After recording the display will show **UPDATE** for several seconds.

Note:

The recorded sound might be distorted when you adjust the recording level to set above 0dB for digital recording and -12dB for analog recording. The default setting of recvolume for digital is 0dB and analog is -12dB when this CD-Recorder is shipped.

Important:

If you want to play the recorded CD-R disc on any regular CD player, it must first be finalized. See finalizing discs.

Finalized CD-RW discs play only on CD-RW compatible CD players.

FINALIZING/UNFINALIZING

The numbers between parentheses refer to the fold-out.

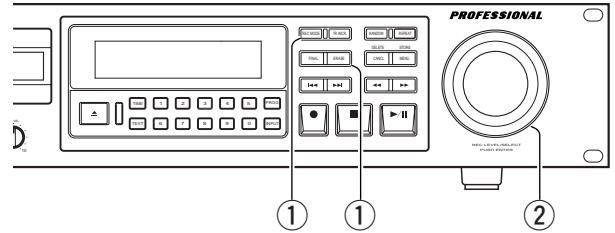
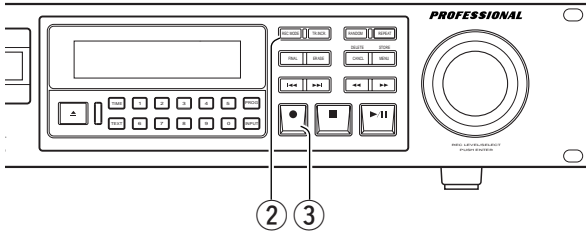

Finalizing CD-R & CD-RW discs

Finalizing is a simple procedure, necessary to:

- be able to play the recorded CD-R(W) disc on a CD PLAYER.
- avoid further unwanted recordings on a disc.
- avoid erasure of tracks on a CD-RW.

Auto finalizing

Auto finalizing is possible when using the MAKE CD recording function.

Manual finalizing

- ① Make sure the disc (in the CD-Recorder) is absolutely free of scratches and dust particles.
- ② With the recorder stopped press **FINAL (27)**.

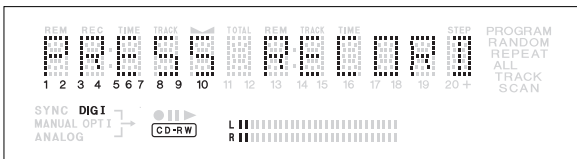
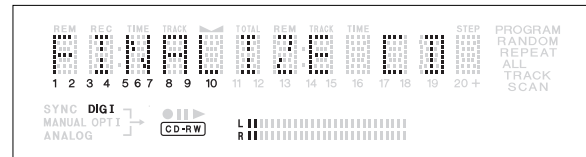

- ③ Press **● (12)**.
 - ***** FINAL** and the approximate finalization time appears on the display.
 - The display counts down through the finalization.
 - On completion, the total number of tracks and the total time recorded appears on the display.
 - For CD-R(W), CD-R(W) changes to CD on display.

Finalizing will take at least 2 - 4 minutes.

Note:

During finalization, the CD-Recorder accepts no operating commands.

Unfinalizing CD-RW discs

For CD-RW discs only.

If you want to make more recordings (or erasures of tracks) on a finalized disc you must unfinalize it first. The Table of Contents (TOC) will be removed.

- ① With the CD-Recorder stopped, press **REC MODE (26)** or **ERASE (24)**.
 - **UNFINALIZE** and **PRESS ENTER** will appear on the display.

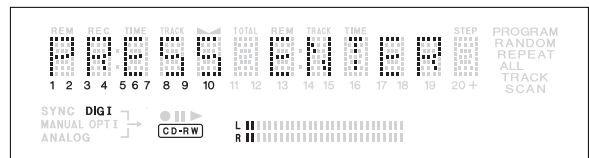
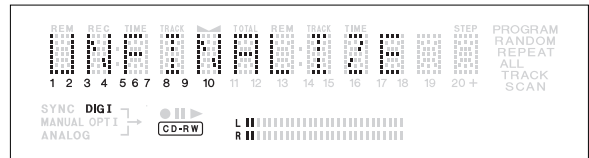

- ② Press **PUSH ENTER (19)**.
 - The disc will now be unfinalized and can be recorded on again.

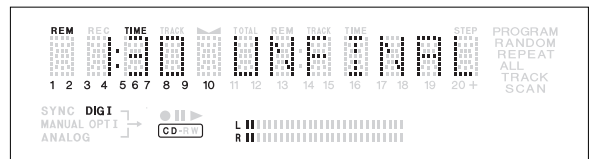

Note:

- Unfinalizing will take approximately 1.5 minutes.
- When unfinalizing a CD-RW disc with text on it available, this text will be transferred to the CD-Recorder memory. It may occur that the text memory is full. The message **MEMORY FULL/FINALIZE CD** will be displayed. You will now have to erase text, stored for other discs, or finalize another disc in order to obtain memory space.

ERASING

The numbers between parentheses refer to the fold-out.

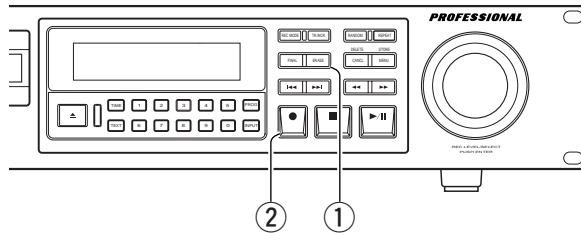
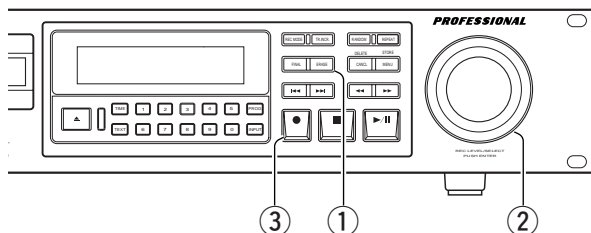

Erasing

For unfinalized CD-RW discs only.

You can erase:

- one or more tracks from the end,
- the entire disc.

Erasing one or more tracks from the end

① Press **ERASE** (24) once.

→ The display shows the number of tracks and their total playing time. **ERASE TRACK** and **PRESS RECORD** lights up.

- If the disc is finalized, CD appears on the display after inserting a CD-RW in the recorder. The recorder will ask you to confirm unfinalizing first. Confirm by pressing the **PUSH ENTER** (19) key or **ENTER** (78) on the remote control.

② Select the track(s) you wish to erase by turning the **REC LEVEL/SELECT** (19) key to the left and confirm by pressing this key.

- The selected track numbers start blinking on the track bar.
- The display shows the remaining number of tracks and the remaining playing time after erasing the selected track(s).

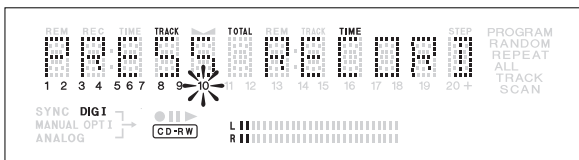
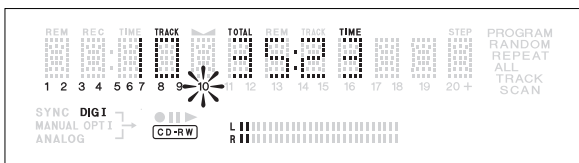

③ Press **●** (12).

- The display shows the total countdown time and **ERASE** appears on the display.
- After the selected track(s) have erased, the display shows the remaining tracks and their total playing time.

Erasing the entire disc

① Press **ERASE** (24) twice.

- The display shows the number of tracks and their total playing time. **ERASE DISC** and **PRESS RECORD** light up.
- If the disc is finalized, CD appears on the display after inserting a CD-RW in the recorder. The recorder will ask you to confirm unfinalizing first. Confirm by pressing the **PUSH ENTER** (19) key or **ENTER** (78) on the remote control.

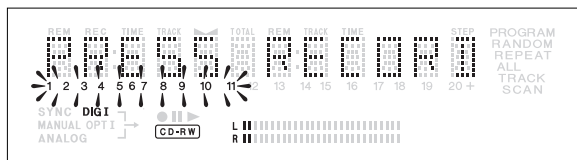
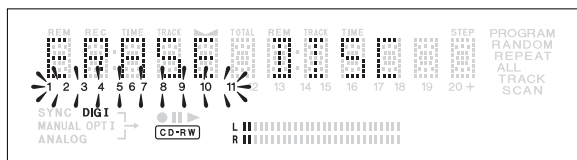

② Press **●** (12).

- The display shows the total countdown time and **ERASE** appears on the display. The complete disc will be erased.

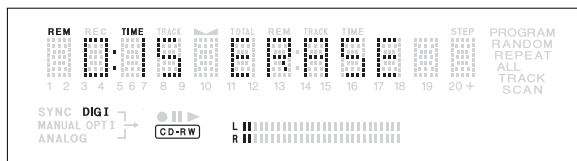

Erasure of a complete disc may take up to 15 seconds.

PLAYING

The numbers between parentheses refer to the fold-out.

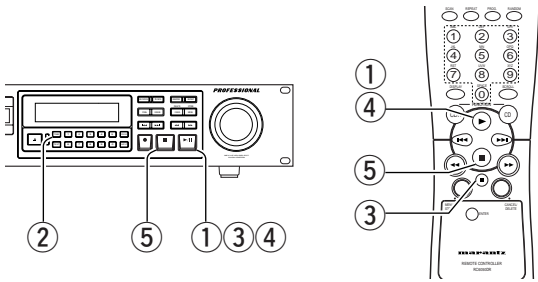

EX: Selecting a track when CD play is stopped

1 On the CDR631 recorder <i>.

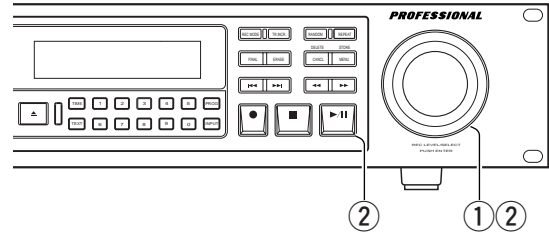

Playing a CD

- ① Press **▶||** (14) to start CD play.
 - ▶ lights up and the track number and track time of the track in play appear on the display.
- ② Press **TIME** (7) or **DISPLAY** (71) once, twice or three times to see:
 - remaining track time, total remaining time, text information (see MENU MODE page 17).
- ③ To interrupt play temporarily, press **▶||** (14) again.
 - || lights on the display.
- ④ To continue play, press **▶||** (14) again.
- ⑤ To stop play, press **■** (13, 81).
 - The number of tracks and the total playing time appear on the display.

Selecting a track

Selecting a track during play

- 1 On the CDR631 recorder <i>.

 - ① Turn the **REC LEVEL/SELECT** (19) key until the required track number appears on the display.
 - Play skips to the beginning of the selected track.

- 2 On the CDR631 recorder <ii>.
 - ① Key in the required track number using the **NUMERICAL** (9) keys. For 2-digit track numbers, press the keys in rapid succession.
- 3 On the CDR631 recorder <iii>.
 - ① Press **◀◀** (15) or **▶▶** (16) one or more times.
 - Play skip to the beginning of the present, previous or subsequent tracks.
- 4 On the remote control <i>.
 - ① Key in the required track number using the **NUMERICAL** (70) keys. For 2-digit track numbers, press the keys in rapid succession.
 - Play skips to the beginning of the selected track.
- 5 On the remote control <ii>.
 - ① Press **◀◀** (74) or **▶▶** (82) one or more times.
 - Play skips to the beginning of the present, previous or subsequent tracks.

Selecting a track when CD play is stopped

- 1 On the CDR631 recorder <i>.
 - ① Turn the **REC LEVEL/SELECT** (19) key until the required track number appears on the display.
 - ② Press **PUSH ENTER** (19) to confirm or press **▶||** (14) to start playing.
- 2 On the CDR631 recorder <ii>.
 - ① Key in the required track number using the **NUMERICAL** (9) keys. For 2-digit track numbers, press the keys in rapid succession.
- 3 On the CDR631 recorder <iii>.
 - ① Briefly press **◀◀** (15) or **▶▶** (16) one more times.
 - ② Start playback by pressing **▶||** (14) or **PUSH/ENTER** (19).
- 4 On the remote control <i>.
 - ① Key in the required track number using the **NUMERICAL** (70) keys. For 2-digit track numbers, press the keys in rapid succession. Play starts.
- 5 On the remote control <ii>.
 - ① Briefly press **◀◀** (74) or **▶▶** (82) one or more times.
 - ② Start playback by pressing **▶** (73) or **ENTER** (78).

PLAYING

The numbers between parentheses refer to the fold-out.

EX: Search

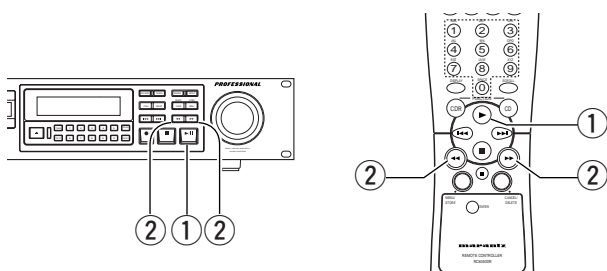

EX: Repeat play

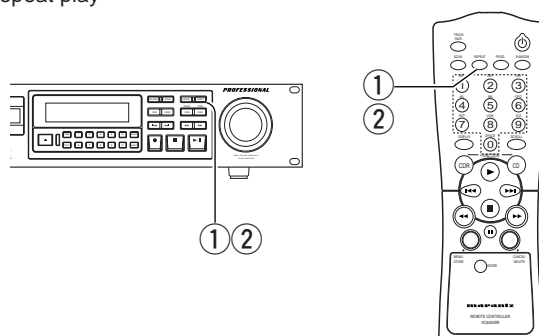

Scan play

- ① To start scan play, press **SCAN** (68) on the remote control.
 - It plays the first 10 seconds of each track.
 - It automatically stops after playing all tracks.
- ② To stop playing, press **■** (13, 81).
 - The SCAN level disappears from the display.

Search

- ① Press **▶/||** (14) or **▶** (73).
- ② Hold down **◀◀** (17, 75) or **▶▶** (18, 80).
 - ➔ The player first searches backwards or forwards at 10 times normal speed with sound at low volume, then goes to 50 times normal speed with sound muted.
- ③ Release the button at the desired passage.
 - ➔ Play starts at the desired passage.

Note:

During Random, Repeat Track or Programmed play, search is restricted to within the track being played at the time.

Random play

- ① Press **RANDOM** (22, 86) before or during CD play to start random play.
 - ➔ The tracks on the CD (or program if set) play in random order.
- ② Press **RANDOM** (22, 86) again to return to normal CD play.

Note:

RANDOM is also cleared if you open the disc tray.

Repeat play

- ① Press **REPEAT** (21, 69) one or more times during CD play.
 - ➔ When **REPEAT TRACK** lights up, the current track plays repeatedly. When **REPEAT ALL** lights up, the disc or program plays repeatedly.

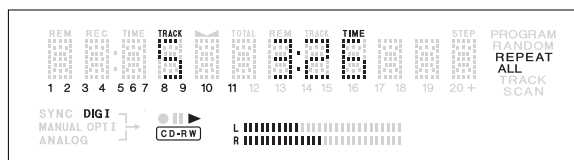

- ② To return to normal play, press **REPEAT** (21, 69) one or more times until:
 - ➔ The **REPEAT** label disappears from the display.

Note:

Repeat is also cleared if you open the disc tray.

PROGRAMMING

The numbers between parentheses refer to the fold-out.

Programmed play

- You can program up to 99 tracks to play in any desired sequence.
- Tracks can be programmed more than once, but each time counts as a track. (step)

Programming for playback

- Press **PROG** (11, 85) on the remote control to enter Program mode.
→ **PROGRAM** flashes and **PROGRAM** appears on the display.

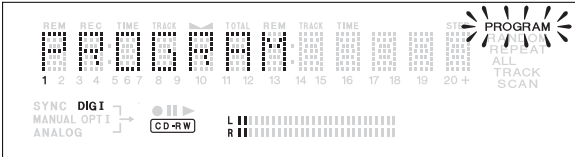

- Select the required track numbers by turning the **REC LEVEL/SELECT** (19) key left or right and store by pressing **PUSH/ENTER** (19).

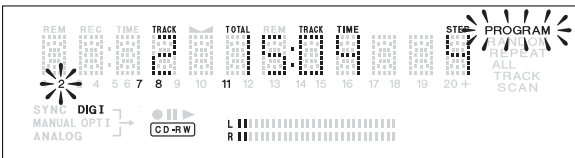

or:

Key in a track number with the NUMBER (9, 70). For 2-digit numbers, press the keys in rapid succession and store by pressing **PUSH/ENTER** (19) on **ENTER** (78).

- The track will be stored in the program.
 - The track number, total program time and the number of programmed tracks (steps) are displayed.
- Repeat step ② for all tracks to be programmed.
 - Press **■** (13, 81) or **PROG** (11, 85) to end programming.
→ **PROGRAM** lights continuously.
 - Press **▶/||** (14) or **▶** (73) to start programmed play.

Clearing a program

- Press **■** (13, 81) if necessary to stop programmed play.
 - Press **■** (13, 81) again to clear the program.
→ **PROGRAM** disappears from the display.
- The program is also cleared if you open the disc tray.

Erasing a track from a program

- In Stop mode press **PROG** (11, 85) to enter Program mode.
- Use **◀◀** (17, 75) or **▶▶** (18, 80) to select the track from which to delete.
→ The track number and program step will be shown on the display.
- Press **DELETE/CANCEL** (23, 79) to erase the track from the program.
→ The remaining program steps and the remaining playing time of the program will be displayed.

MENU MODE

The numbers between parentheses refer to the fold-out.

EX: Storing names of Text settings

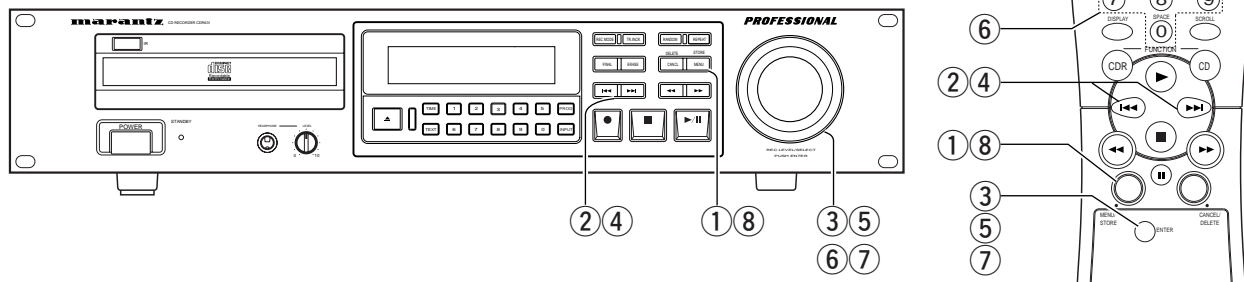

About MENU MODE

MENU MODE can set up more sophisticated setting for making CDs. There are two kinds of submenus in the MENU MODE.

- Text submenus adding and erasing the CD text
- Recording submenus ... Auto track increment ON/OFF
 - ... Auto stop ON/OFF
 - ... Copy protection
 - ... Adjusting right-left-volume balance during the recording

Note:

TEXT can only be edited for finalized discs. (finalized CD-RW discs must be unfinalized)

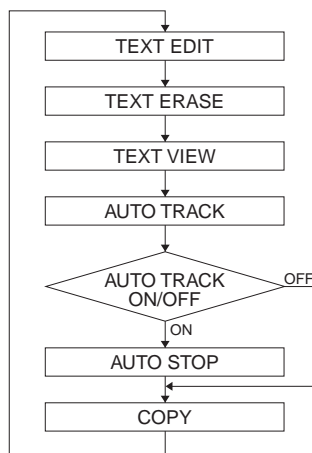

Structure of MENU MODE in the STOPMODE

Note:

When AUTO TRACK increment is OFF, AUTO STOP does not appear on the display.

Text Submenus

The TEXT submenus allows you to enter text information on the CD-R(W); for example the CD titles, the artist names, the track names and so on. During the playback, the TEXT will be appeared on the display.

Storing names

- 1 Press **STORE/MENU (20, 77)** to enter Menu mode. **TEXT EDIT** appears on the display.
- 2 Rotate **REC LEVEL/SELECT (19)** or press **◀◀ (15, 74)**, **▶▶ (16, 82)** to select the **TEXT EDIT** submenus.
- 3 Press **PUSH ENTER (19)** or **ENTER (78)** to confirm.
- 4 Rotate **REC LEVEL/SELECT (19)** or press **◀◀ (15, 74)**, **▶▶ (16, 82)** to select the required option in the submenu: **CD Artist, CD Title, Track 1 Artist, Track 1 Title**, etc.
- 5 Press **PUSH ENTER (19)** or **ENTER (78)** to confirm.
- 6 Select the characters by rotating the **REC LEVEL/SELECT (19)** or by pressing the corresponding numeric/alphabet key (70).

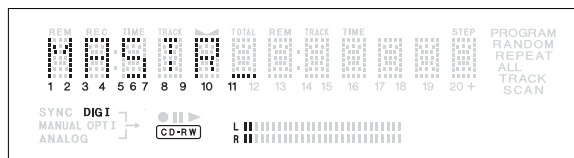

- 7 Press **PUSH ENTER (19)** or **ENTER (78)** to store the characters and move to the next cursor position.

Note:

- A maximum of 60 characters can be stored per item.
- With the **◀◀ (17)** **▶▶ (18)** keys you can move to a required cursor position.
- With the **CANCEL/DELETE (23, 79)** you can delete a character.
- By pressing the **PUSH ENTER (19)** or **ENTER (78)** without selecting a character first, you can insert a space between characters.
- When an artist's name has been stored for a certain track, the name will automatically be copied for the next track. The name can be confirmed by pressing **STORE/MENU (20, 77)** or a new name can be entered as described above.

- 8 Press **STORE/MENU (20, 77)** to store a name you have entered and return to the submenu or **■ (20, 81)** to exit.

MENU MODE

The numbers between parentheses refer to the fold-out.

Erasing names

- ① Stay in the stop mode. (No Operation)
- ② Press **STORE/MENU** (20, 77) on the deck or the remote control to enter Menu mode.
- ③ Rotate **REC LEVEL/SELECT** (19) or press **◀◀** (15, 74), **▶▶** (16, 82) to select the submenu **TEXT ERASE**. **TEXT ERASE** appears on the display.
- ④ Press **PUSH ENTER** (19) or **ENTER** (78) on the remote control to confirm.
- ⑤ Rotate **REC LEVEL/SELECT** (19) or press **◀◀** (15, 74), **▶▶** (16, 82) to select the required option in the submenu: All Text, CD Title, CD Artist, Track 1 Title, Track 1 Artist, etc.
- ⑥ Press **PUSH ENTER** (19) or **ENTER** (78) to confirm. The display will ask you to reconfirm your selection.
- ⑦ Press **PUSH ENTER** (19) or **ENTER** (78) to reconfirm.
- ⑧ Press **STORE/MENU** (20, 77) to return to the submenu or **■** (13, 81) to exit.

About TEXT

The input text data is saved in the text memory until the disc is finalized. Therefore, the data is not written in the CD-R(W) disc before finalizing the disc.

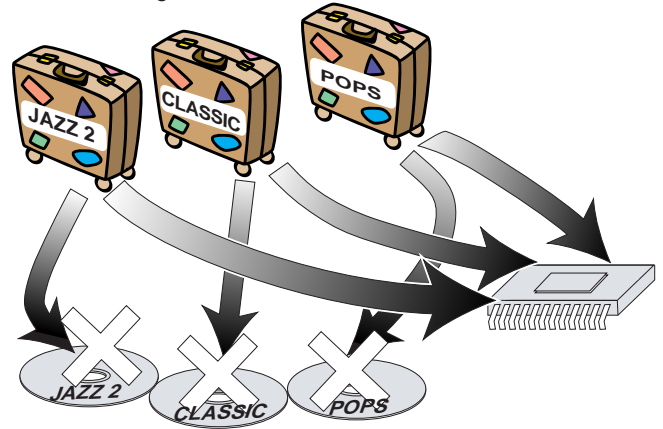

Finalizing the disc transfers the text data from the text memory to the disc.

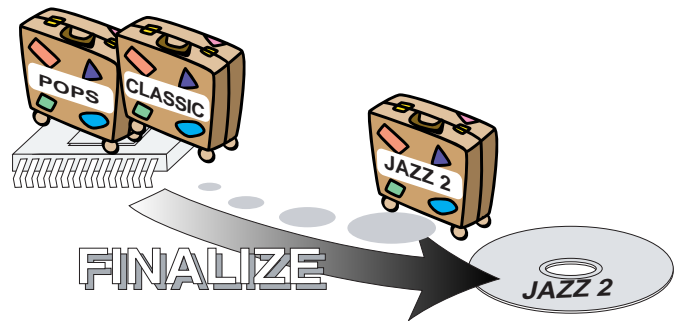

Unfinalizing the disc transfers the text data from the disc to the text memory.

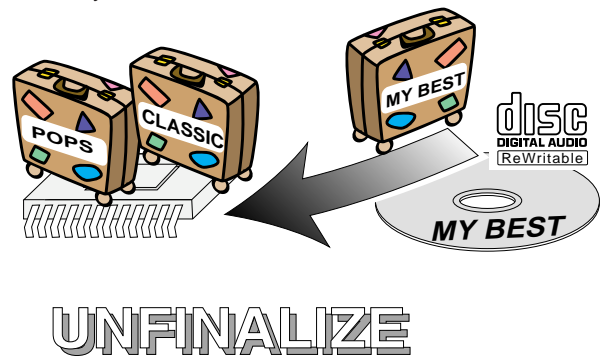

When the text memory is full, **MEMORY FULL** appears on the display and you cannot add more text data.

In this case, you need to make more space in text memory. You can either finalize one or more disc(s) to transfer the text data to each disc, or erase (part of) the text data in the text memory.

Note:

When the text memory is full depends on the amount of the input text data per disc and the number of discs.

Typically the text memory can store for 50 discs of the text data consisting of 60 characters of an artist name or title for 20 tracks.

MENU MODE

The numbers between parentheses refer to the fold-out.

Text Memory Review/Erase Text Memory

The input text data of the disc is once saved in the text memory until finalizing the disc. When the text memory is full, MEMORY FULL will appear on the display and unable to add more text data. If you want to add more text data, you have to finalize the text data for each disc in order to obtain memory space or erase the entire memory following the operation below.

- ① Stay in the stop mode. (No Operation)
- ② Press **STORE/MENU** (20, 77) on the deck or the remote control to enter Menu mode.
- ③ Rotate **REC LEVEL/SELECT** (19) or press **◀◀** (15, 74), **▶▶** (16, 82) to select the **TEXT VIEW** submenu. **TEXT VIEW** appears on the display.
- ④ Press **PUSH ENTER** (19) or **ENTER** (78) to confirm.
- ⑤ Rotate **REC LEVEL/SELECT** (19) or press **◀◀** (15, 74), **▶▶** (16, 82) to select the disc you wish to erase.

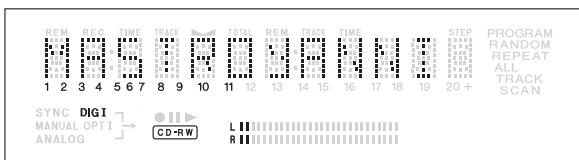

- ⑥ Press **PUSH ENTER** (19) or **ENTER** (78) to confirm. **ERASE MEMORY** appears on the display.

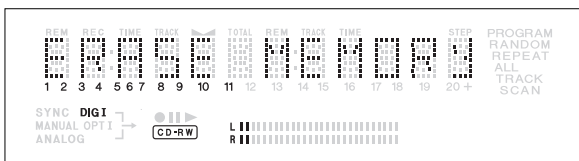

- ⑦ Press the **PUSH ENTER** (19) or **ENTER** (78) to confirm the erasure of the text for that particular disc.
- ⑧ Press **STORE/MENU** (20, 77) to return to the submenu or **■** (13, 81) to exit.

Note:

- If there are no discs in the memory, the message **MEMORY EMPTY** appears on the display.
- **MEMORY FULL/FINALIZE CD** may also appear when unfinalizing a CD-RW disc for which text was stored (see 'UNFINALIZING CD-RW discs' page 12.). The same action(s) should be taken in order to obtain memory space.

Recording submenus

- When Auto Track is ON, track numbers will automatically be increased during the recording, also able to set Auto stop ON/OFF.
- You can adjust the right and left volume balance during the recording.

Auto track increment

- ① Stay in the stop mode. (No Operation)
- ② Press **STORE/MENU** (20, 77) on the deck or the remote control to enter Menu mode.

- ③ Rotate **REC LEVEL/SELECT** (19) or press **◀◀** (15, 74), **▶▶** (16, 82) to select the **AUTO TRACK** submenu. **AUTO TRACK** appears on the display.
- ④ Press **PUSH ENTER** (19) or **ENTER** (78) to confirm.
- ⑤ Select Auto track **ON** or **OFF** by rotating **REC LEVEL/SELECT** (19) or press **◀◀** (15, 74), **▶▶** (16, 82).

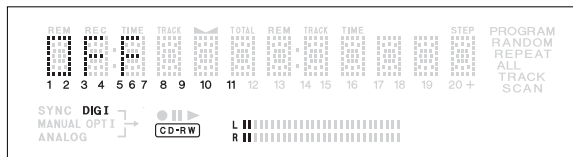

- ⑥ Press **PUSH ENTER** (19) or **ENTER** (78) to confirm.
 - When **ON** is selected, track numbers will be automatically incremented during recording.
 - When **OFF** is selected, you can number the recorded tracks yourself by press **TR.INCR.** (25) or **TRACK INCR** (67).
- ⑦ Press **STORE/MENU** (20, 77) to store settings and return to the submenu or **■** (13) to exit.

| AUTO TRACK | | ON |
|------------------------------------|--|---|
| Source | | |
| CD/MD (with user data) | | Track increment based on user data of incoming signal |
| DAT/DCC (with user data) | | Track increment based on user data of incoming signal |
| Unknown (no user data) | | Track increment after silence gap of 2.7 seconds on incoming signal |
| Analog | | Track increment after silence gap of 2.7 seconds on incoming signal |
| No source (no lock) | | None |

Note:

- Auto track is a function to switch increasing the track numbers either automatically or manually. When Auto track is ON, there are two ways to activate the function.
- If a digital source has track information (Q-subcode) such as CD or MD, the track transition is automatically increased according to track information of the digital source.
- If an audio source is analog or digital without track information, silence gap is detected. When length of silence gap is more than 2.7 seconds, the auto track function is automatically activated at the point of 2.7 seconds just before A (-35 dB) is detected. (See following figure below.)

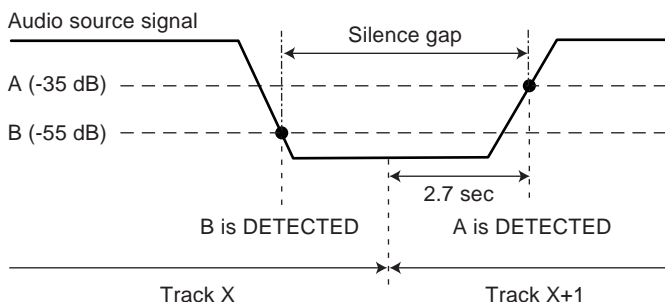

MENU MODE

The numbers between parentheses refer to the fold-out.

Auto stop

Note:

Set Auto track increment ON, otherwise AUTO TRACK does not show on the display.

- ① Set stop mode.
- ② Press **STORE/MENU (20, 77)** on the deck or the remote control to enter Menu mode.
- ③ Rotate **REC LEVEL/SELECT (19)** or press **◀◀ (15, 74), ▶▶ (16, 82)** to select the **AUTO STOP** submenus. **AUTO STOP** appears on the display.
- ④ Press **PUSH/ENTER (19)** or **ENTER (78)** to confirm.
- ⑤ Select Auto stop **ON** or **OFF** by rotating **REC LEVEL/SELECT (19)** or press **◀◀ (15, 74), ▶▶ (16, 82)**.
AUTO STOP ON : fully automatic stop.
AUTO STOP OFF : only manual stop during the recording.

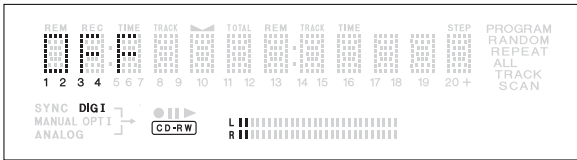

- ⑥ Press **PUSH/ENTER (19)** or **ENTER (78)** on the remote control to confirm.
- ⑦ Press **STORE/MENU (20, 77)** to store setting and return to the submenu, or press **■ (13, 81)** to exit.

| AUTO STOP | ON |
|--|--|
| Source | |
| CD/MD (with user data) | Stop after 3 seconds of user DATA of stop pattern detected on the incoming source signal |
| DAT/DCC (with user data) | Stop after 20 seconds of silence |
| Unknown (no user data available) | Stop after 20 seconds of silence |
| Analog | Stop after 20 seconds of silence |
| No source (no lock) | Stop after 3 seconds of unlock |

Copy protection

- ① Set stop mode.
- ② Press **STORE/MENU (20, 77)** to enter Menu mode.
- ③ Rotate **REC LEVEL/SELECT (19)** or press **◀◀ (15, 74), ▶▶ (16, 82)** to select the Copy submenus. **COPY** appears on the display.
- ④ Press **PUSH/ENTER (19)** or **ENTER (78)** to confirm.

- ⑤ Select Copy **ON, OFF, or HCO** by rotating **REC LEVEL/SELECT (19)** or press **◀◀ (15, 74), ▶▶ (16, 82)**.

Copy protection OFF:

makes this recording 'copy permitted.' Unlimited copies can be made by a Consumer CD-Recorder.

Copy protection ON:

makes this recording 'copy protected.' One 'Home Copy of protected Original' can be made from this recording; this copy (HCO) cannot be reproduced by a Consumer CD-Recorder.

Home Copy of Original:

make this recording a 'Home Copy of protected Original' (HCO) straight away. NO copy can be made from this recording by a Consumer CD-Recorder.

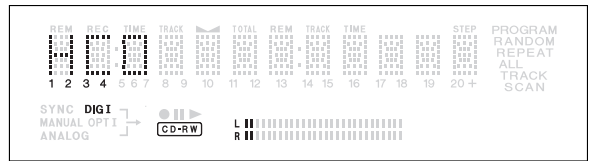

- ⑥ Press **PUSH/ENTER (19)** or **ENTER (78)** to confirm.
- ⑦ Press **STORE/MENU (20, 77)** to store setting and return to the submenu, or press **■ (13, 81)** to exit.

Note:

- Since this CD-recorder is a professional CD-Recorder, all CDs can be copied even with HCO.
- Making an analog copy is always possible from the recorded CD-R(W) disc even selected either OFF, ON or HCO.

Balance (Only active in Record/Standby mode)

- ① Press **STORE/MENU (20, 77)** to enter Menu mode.
- ② Rotate **REC LEVEL/SELECT (19)** or press **◀◀ (15, 74), ▶▶ (16, 82)** to select the **SET BALANCE** submenu. **SET BALANCE** appears on the display.

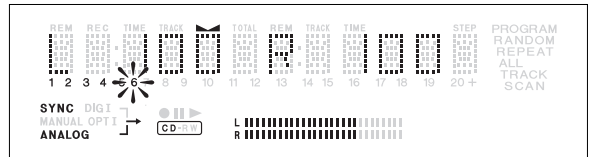

- ③ Press **PUSH ENTER (19)** or **ENTER (78)** to confirm. **→ ◀** and **L 100 R 100** appear on the display.
- ④ Adjust the recording balance by turning the **REC LEVEL/SELECT (19)** or press **◀◀ (15, 74), ▶▶ (16, 82)**.
- ⑤ Press **PUSH ENTER (19)** or **ENTER (78)** to confirm.
- ⑥ Press **STORE/MENU (20, 77)** to store settings.

Note:

The balance setting will not be stored.

DISPLAY

Messages, as listed and explained here, may appear on the display for your guidance.

General

- READING..... reading disc information
- OPEN..... during tray opening
- CLOSE..... during tray closing
- NO DISC..... no disc inserted, disc unreadable or disc inserted upside down
- PROG FULL..... program full
- INSERT DISC..... insert disc or insert disc in correct way
- WRONG DISC..... inserted disc is no audio CD
- UNFINALIZED..... unfinalized CD-R(W) disc
- MEMORY %/6..... indicates the amount of text memory used for unfinalized discs

Recording

- WAIT..... - when ■ STOP is pressed during recording
- when ■ STOP is pressed during recording the first 4 seconds of a track
- UPDATE..... updating disc contents
- DISC FULL..... no more recording possible
- DIGITAL 1..... digital coaxial input 1 selected
- OPTICAL..... digital optical input selected
- ANALOG..... analog input selected
- COPY PROTECT..... no digital recording can be made of the external source
- NOT FINALIZED..... when opening the tray with an unfinalized disc inserted (in the CD-Recorder)
- MAKE CD..... Start of synchronised recording of a complete disc and Auto Finalize function selected
- RECORD DISC..... Start of synchronised recording of a complete disc
- RECORD TRACK..... Start of synchronised recording of a single track
- REC MANUAL..... manual start of recording selected
- * * 0..... level is being adjusted
- DOES NOT FIT..... time left on CD-R(W) disc is not enough for proposed recording
- ERASE TRACK..... when erasing one or more tracks
- ERASE DISC..... when erasing a disc
- FINALIZE CD..... when finalizing a disc
- CHECK INPUT..... when ● is pressed while no digital source is detected
- * * * * ERASE..... time countdown when erasing a track or a disc
- * * * * FINAL..... time countdown when finalizing a disc
- PRESS RECORD..... to start manual recording, finalizing or erasing
- START SOURCE..... to start synchronised recording from a source

- FINALIZED..... when trying to record on a finalized CD-R(W) or a prerecorded CD
- UNFINALIZE..... when trying to record on a finalized CD-RW
- PRESS ENTER.....
- PROF SOURCE..... when a professional source is connected

Play

- PROGRAM..... program mode selected
- ALBUM TITLE..... will be followed by album title
- TRACK TITLE..... will be followed by track title
- ALBUM ARTIST..... will be followed by artist name
- TRACK ARTIST..... will be followed by track artist name

Others

- NO AUDIO TR..... when the recorder enters a data track during recording
- FINALIZED CD..... laser power calibration performed 96 times, finalize disc
- INITIALIZING..... during laser power calibration for unfinalized discs
- DISC RECOVER..... during disc recovering after power failure
- OPC ERROR..... OPC failure during OPC procedure (OPC = Optimum Power Calibration)
- RECORD ERROR..... recording error in menu mode
- DISC ERROR..... when trying to record on or finalize a recovered disc
- MEMORY FULL..... when text memory is full. To add a CD to the list, first finalize or erase another disc from the list.
- FINALIZED CD.....

DISPLAY

Menu messages

| | |
|--------------------|--|
| NO TRACKS | when attempting to edit text for a disc which has no tracks |
| TEXT EDIT | when entering Text Edit mode |
| CD ARTIST | when editing or erasing an artist name |
| CD TITLE | when editing or erasing a title |
| ARTIST TR N | when editing or erasing an artist name per track |
| TITLE TR N | when editing or erasing a title per track |
| TEXT ERASE | when entering Text Erase mode |
| ALL TEXT | when entering All Text mode |
| ERASE OK | when confirmation for erasing has to be given with ENTER key |
| ERASE ALL OK | when confirmation for erasing has to be given with ENTER key |
| ERASE MEMORY | when waiting for confirmation when erasing a disc |
| TEXT VIEW | when selecting text review per unfinalized disc in memory |
| MEMORY EMPTY | when REVIEW is selected while no text is in memory |
| AUTO TRACK | when selecting auto track increment ON or OFF |
| ON | Auto Track increment on |
| OFF | Auto Track increment off |
| SET BALANCE | when selecting BALANCE |
| NO TEXT | no text stored for disc |

OTHER INFORMATIONS

The numbers between parentheses refer to the fold-out.

Fixing problems

If you think your CD-Recorder is defective, it is wise to read this list first. Maybe you forgot a simple step.

Warning!

Under no circumstances should you attempt to repair the CD-recorder yourself as this will invalidate the guarantee.

No power

- ensure that the **POWER ON/OFF** (1) button is on: the CD-Recorder is in standby mode, press any button to activate it
- ensure that the power cord is plugged in correctly
- switch the recorder OFF and then immediately back ON

Auto track does not work

- check if auto track is selected
- check if there are 2.7 seconds silence in between the tracks (analog recording only)
- check if the source is consumer source with the digital output according to IEC audio standard
- source is DVD disc (no track information)

No sound

- check the audio connections
- if using an amplifier, try using a different source

Amplifier sound is distorted

- check that the CD-Recorder analog output is not connected to the amplifier PHONE input.

Play will not start

- ensure that the label of the CD is facing up
- clean the disc
- check that the disc is not defective by trying another disc

Remote control does not work

- point the remote control directly at the CD-Recorder
- check the batteries and replace if necessary
- select the right source first
- set the remote control selector to 'INTERNAL'

Will not record

- clean the disc
- check if CD-R(W) is an unfinalized disc
- check that the disc is recordable and replace if necessary
- the disc is not an audio disc (WAVING DISC)
- wrong input source chosen.
- text memory full (MEMORY FULL / FINALIZE CD). When a CD-RW has to be unfinalized for recording. Erase text for other disc(s) or finalize other disc(s) to obtain memory space.

Recording is distorted

- make sure the recording level was not too high

20 second pause between recordings

- see 'RECORDING' CD SYNC

OTHER INFORMATIONS

The numbers between parentheses refer to the fold-out.

Player does not react

- use the **POWER ON/OFF** (1) button on the front of the Player to switch it off and back on

DISC RECOVER on display

- a power failure has occurred during recording the CD-Recorder is attempting to repair the disc
- If **DISC ERROR** then appears on the display, the disc cannot be recorded further, and cannot be finalised. But it can still be played on the CD-Recorder or another CD-Recorder.
- on a CD-R(W) disc, the track being recorded is lost, but further recording and finalisation can still be done

Rergarding addresses for your local Marantz dealers,
please visit us on the web at
<http://www.marantz.com>.

marantz® is a registered trademark.

