

DUBUgcbJWHY`Yd\cbY`GngHYa g

Panasonic KX-TD7580, KXTD7580, TD7580



www.voicesonic.com

Phone: 877-289-2829



DECT Portable Station Operating Instructions

Model KX-TD7580

Contents

Setting Up.....	2	Specifications.....	20
Turning the Power On and Display.....	3	English	21-40
Operation.....	4	Deutsch	41-60
Using the Phonebook.....	6	Français	61-80
Handset Programming.....	13	Nederlands	81-100
Important Information.....	18	Svensk	101-120

English

Deutsch

Français

Nederlands

Svensk

Accessories (included)

- AC Adaptor
- Handset Cover
- Charger
- Batteries
- Operating Instructions

- Belt Clip



To attach

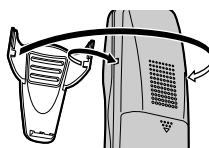

- **Thank you for purchasing a DECT Handset (= Portable Station PS).**
- **Charge the battery for about 15 hours before initial use.**
- This manual is designed to be used with your Handset and a Panasonic KX-TD816/KX-TD1232 system.
- In this manual, the last letter of each model number is omitted.

The handset supports the single line telephone (SLT) features. Please refer to the appropriate section in the User Manual for the KX-TD816/1232 system to operate the handset. Some of the features are not available.

Setting Up

Handset (PS)

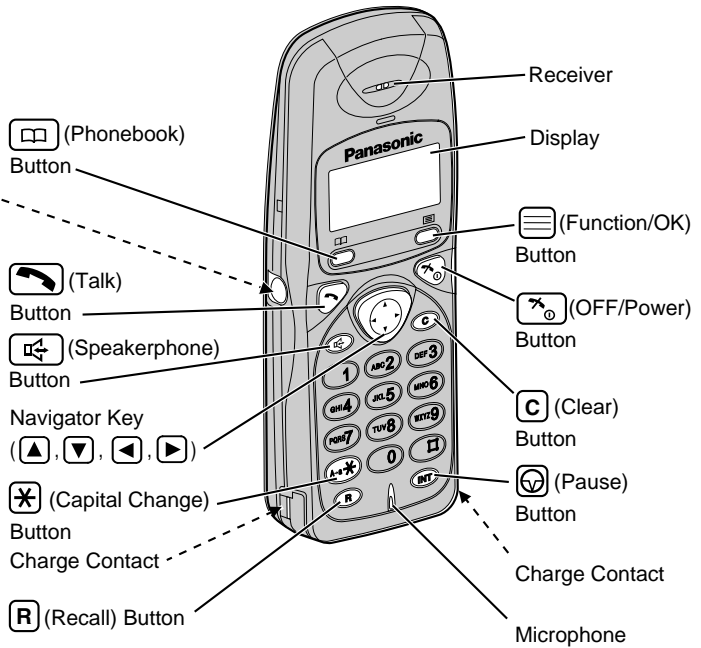
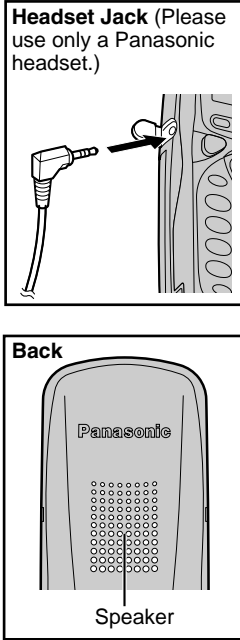

Insert and charge the batteries for about 15 hours as shown below.

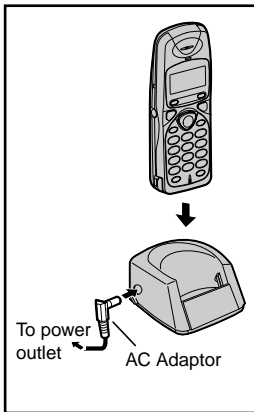
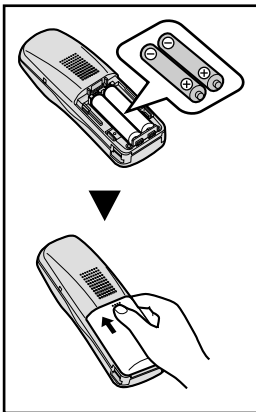

Mount the charger securely on the wall.

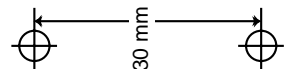
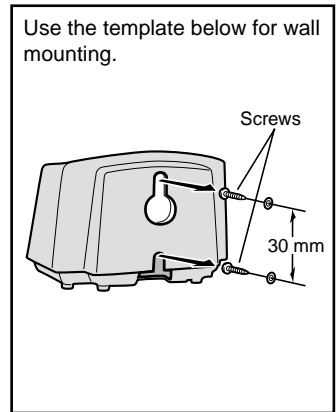

Turning the Power On and Display

To turn the power ON, press and hold .

Before using the handset, turn the power ON.

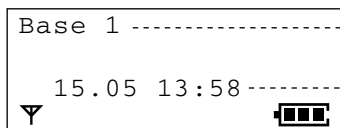

The current connected base unit number:
You can choose whether to display the base unit number, extension number or no display in the standby mode by programming (p. 13).

The current date and time

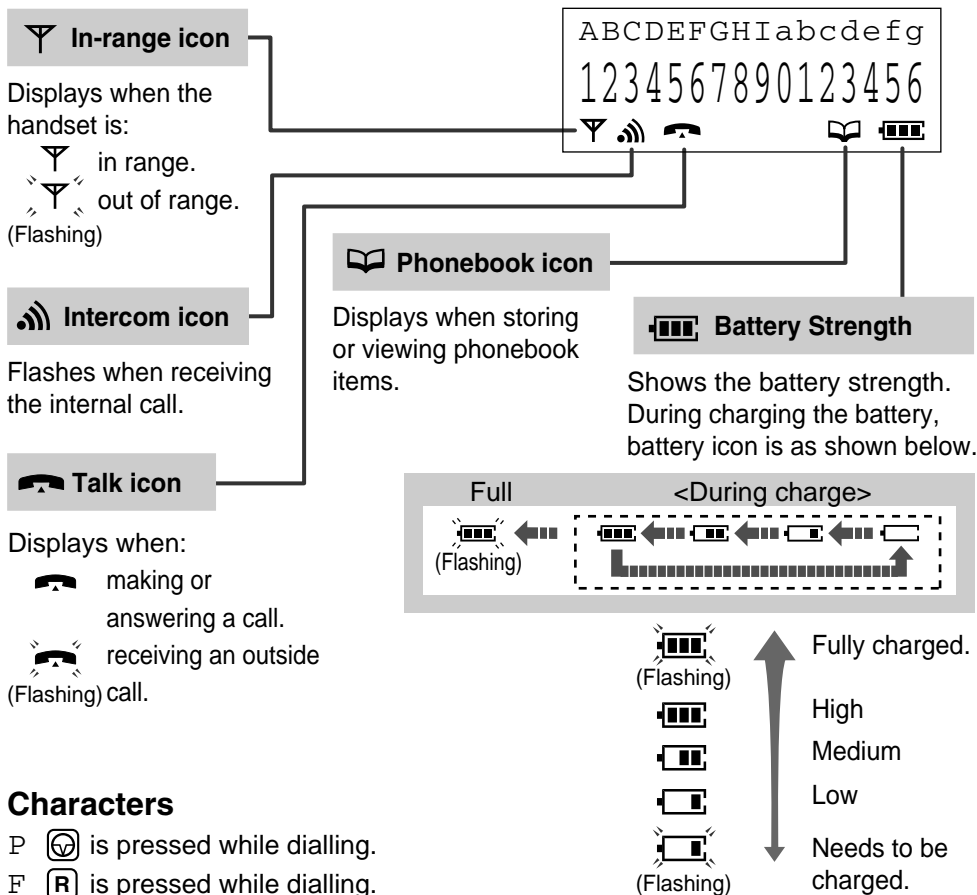

- To turn the power OFF, press and hold  until a beep sounds.
- To change the display language, see page 13.

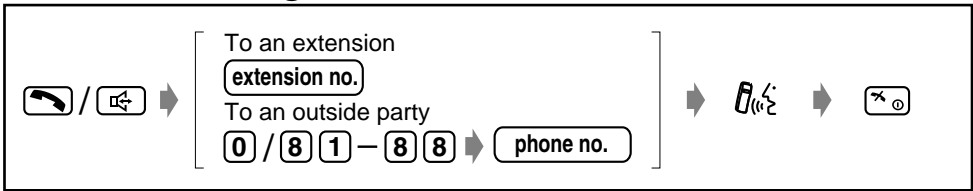

Operations

◆◆ Basic Calling



- While talking, you can switch back and forth between the hands-free phone conversation (press ) and the receiver (press ).
- **Predialling** : You can dial first, and then go off-hook.

◆◆ Redialling

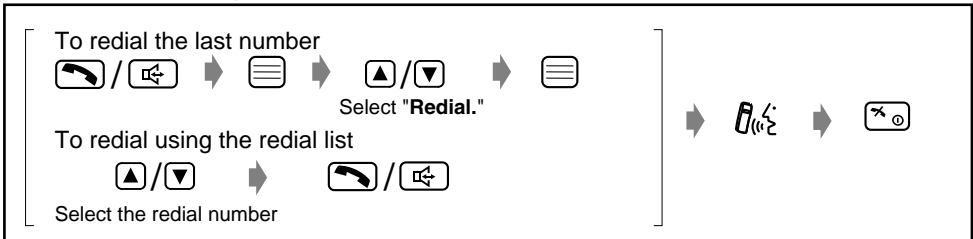

◆◆ Receiving Calls





- **Quick Answer**: If you set the quick answer feature ON (p. 13), you can answer a call by lifting the handset off the charger without pressing a button.
- When receiving a call from a caller registered in the phonebook, the caller's name and phone number will appear on the display.

◆◆ Transferring Calls



Notes

- If you misdial, press . To cancel, press and hold  or press .
- You can also hang up by placing the handset on the charger.



◆◆ Tone Signalling

During an outside call, you can transmit tone signals automatically using the keypad (e.g., to control answering system remotely).



◆◆ Clearing the Number in the Redial Memory

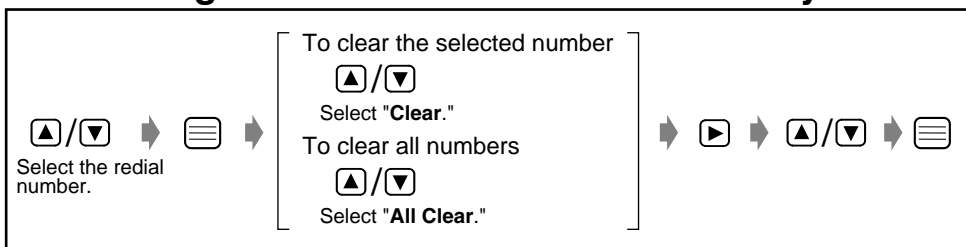

◆◆ Adjusting the Receiver/Speaker Volume

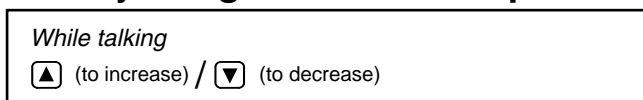

◆◆ Turning the Handset Ringer off Temporarily

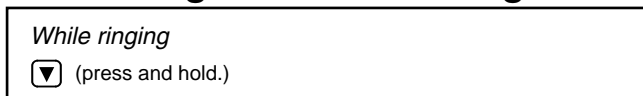

- The ringer will turn back on for the next call.
- This function will not work when the handset is on the charger.

◆◆ Setting the Key Lock

You can lock the handset dialling buttons. Only incoming calls are accepted until the key lock is cancelled. While locked, "[X]" will be shown on the display.

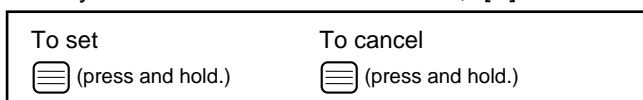

Using the Phonebook

You can store up to 100 names and phone numbers in the phonebook. All phonebook items are sorted by the first word in alphabetical order. Using the phonebook, you can make a call by selecting a name on the display.

- If the phonebook is locked (p. 6), enter the 4-digit handset PIN to go to the phonebook list.
- You can exit the phonebook setting mode anytime by pressing .
- When programming is completed, a beep sounds.

◆◆ Using the Private Category Feature

You can select the display backlight colour and ringer type for each private category (p. 13). When receiving a call, you can easily figure out who has called. (For example, Category 1 for family, Category 2 for friends and Category 9 for business.)

If you do not assign an item to any private category number, the handset will ring in the preset ringer type and light in the preset colour when receiving a call.

◆◆ Storing Names and Numbers in the Phonebook

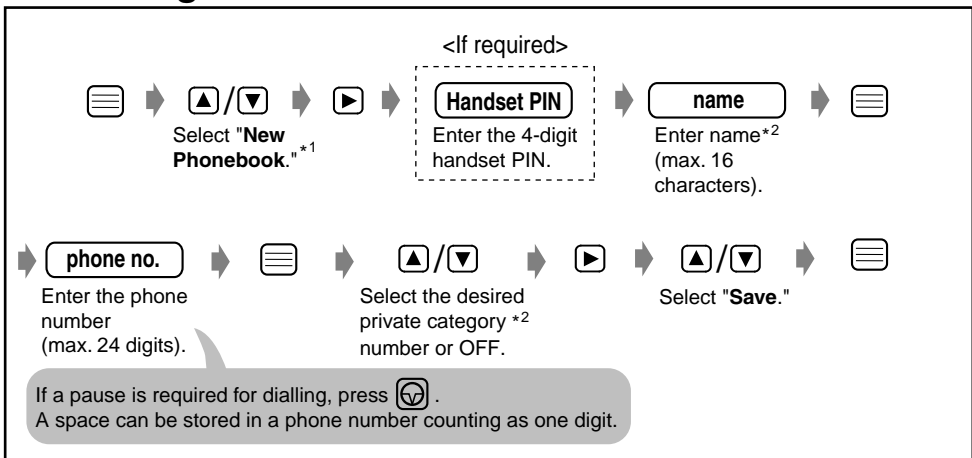

*1 If the display shows "Memory Full," the display will return to the standby mode. Clear other stored items in the phonebook (p. 10).

*2 See the steps for entering names and symbols (p. 7).



◆ Storing a Redial or Predial Number

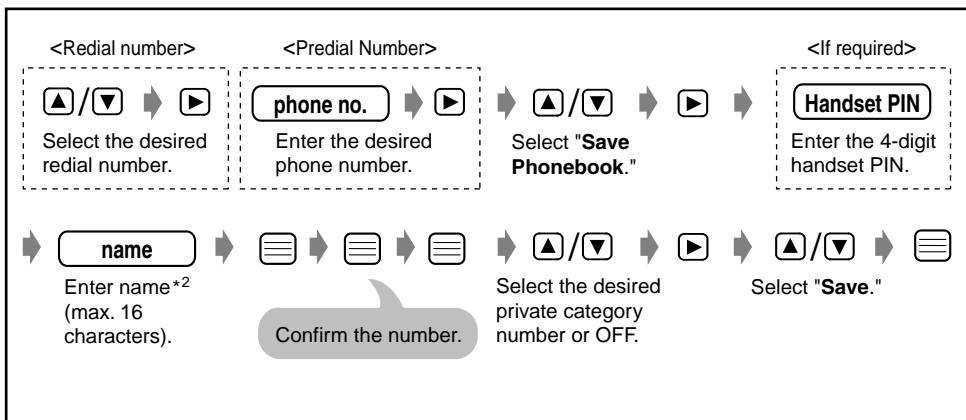

◆◆ Entering Characters

The dialling buttons can be used to enter letters and character symbols. The letters are printed on the dialling buttons.

◆ Selecting the Character Mode

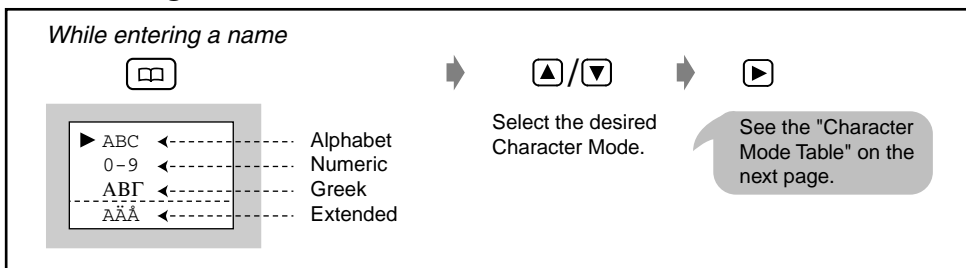

For example, to enter "Anne":

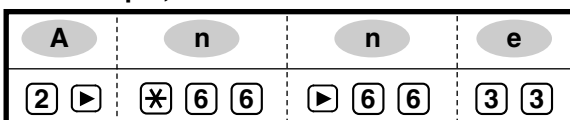



◆ Character Mode Table

Buttons	ABC (Alphabet)	0-9 (Numeric)	ABC (Greek)	AAÄ (Extended)
[1]	# & ' () * , - . /	1	# & ' () * , - . /	# & ' () * , - . /
	# & ' () * , - . /	1	# & ' () * , - . /	# & ' () * , - . /
[2]	A B C	2	ΑΒΓ	À Á Â Ã Ä Å Æ Β Ç Ç
	a b c	2	ΑΒΓ	à á â ã ä å æ β ç ç
[3]	D E F	3	ΔΕΖ	Đ Ě Ę É Ê Ë Ę F
	d e f	3	ΔΕΖ	d ě è é ê ë ě f
[4]	G H I	4	ΗΘΙ	Ğ Ğ H I İ İ İ İ İ
	g h i	4	ΗΘΙ	ğ ğ h i i i i i i
[5]	J K L	5	ΚΑΜ	J K L
	j k l	5	ΚΑΜ	j k l
[6]	M N O	6	ΝΞΟ	M N Ñ O Ò Ó Ô Õ Ø
	m n o	6	ΝΞΟ	m n ñ o ò ó ô õ ø
[7]	P Q R S	7	ΠΡΣ	P Q R S Ş ß
	p q r s	7	ΠΡΣ	p q r s ş ß
[8]	T U V	8	ΤΥΦ	T U Û Ú Ó Ü Û V
	t u v	8	ΤΥΦ	t u ù ú ó ü ù v
[9]	W X Y Z	9	ΧΨΩϺ	W X Y Z
	w x y z	9	ΧΨΩϺ	w x y z
[0]	blank	0	blank	blank
	blank	0	blank	blank
[←]	To move the cursor █ to the left.			
[→]	To move the cursor █ to the right. (To enter another character using the same dialling button, move the cursor to the next space.)			
[C]	To erase the character. To erase all characters, press and hold.			
[✳]	To shift from capital to lower case, press [✳]. Each time you press [✳], the mode will change.			



◆◆ Finding Items in the Phonebook

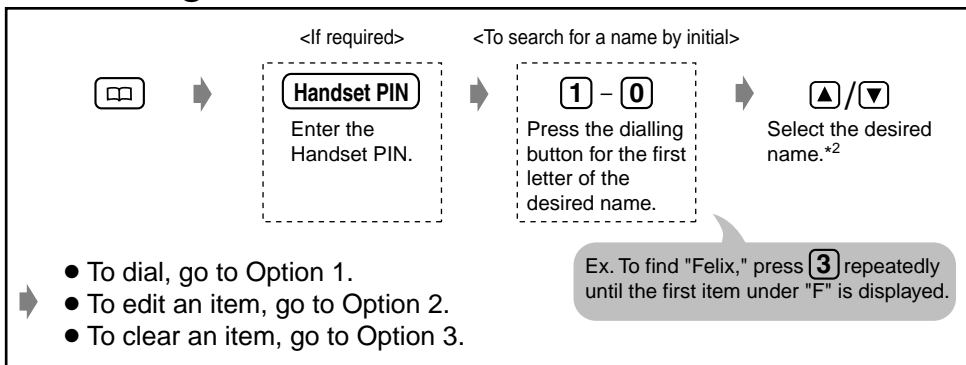

*1 If "No Numbers Stored" is displayed, the phonebook is empty. The handset will return to the standby mode.

*2 All phonebook items are sorted in the following order:
Character → Symbol → Number

◆ Option 1: Dialling from the Phonebook

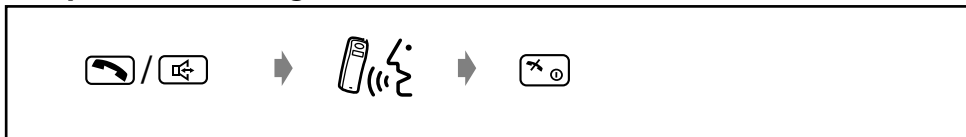



◆◆ Using the Hot Key Dial Feature

The dialling buttons (1-9) function as one-touch dials. You can assign up to 9 phone numbers from the phonebook items into dialling buttons as hot key dials.

◆ Storing Phonebook Items as Hot Key Dials

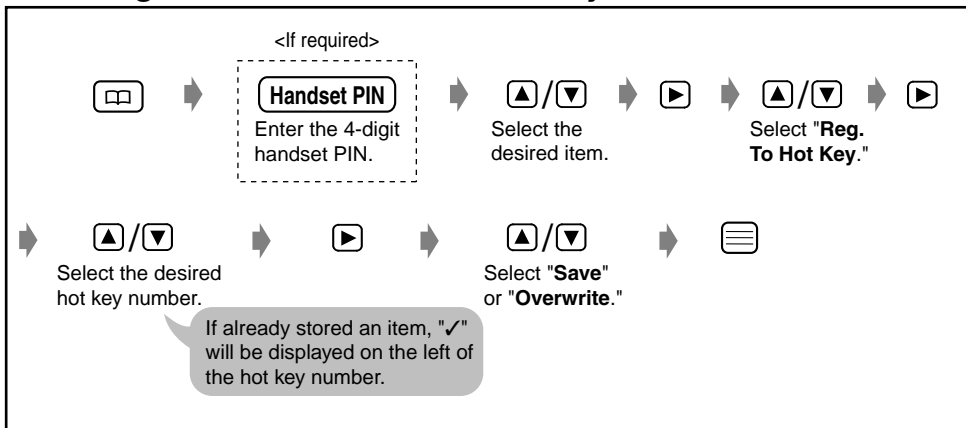

◆ Dialling a Stored Number

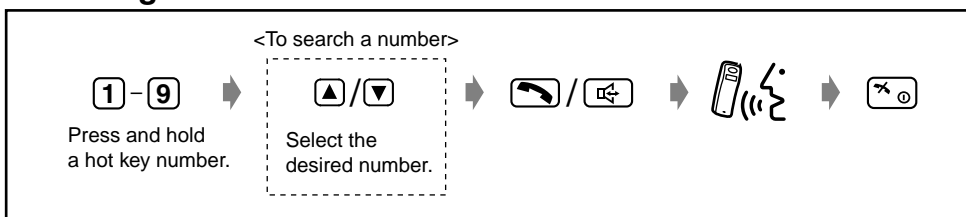



◆ Clearing an Item in the Hot Key Dial

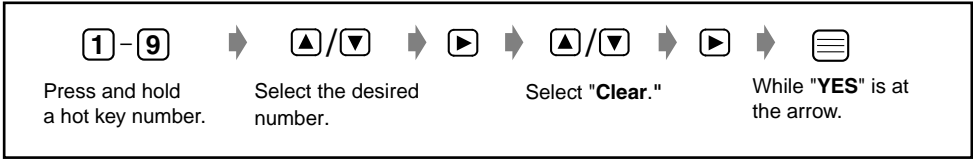

◆◆ Locking the Phonebook

See page 13.

Handset Programming

You can programme the following function items. The display shows the instructions. After selecting "Setting Handset," the main menu is displayed. Most items in the main menu have a sub-menu. The sub-menu is shown after selecting the item in the main menu. Main menu items are written in bold and sub-menu items are under each main menu item.

◆◆ Handset Programming Menu

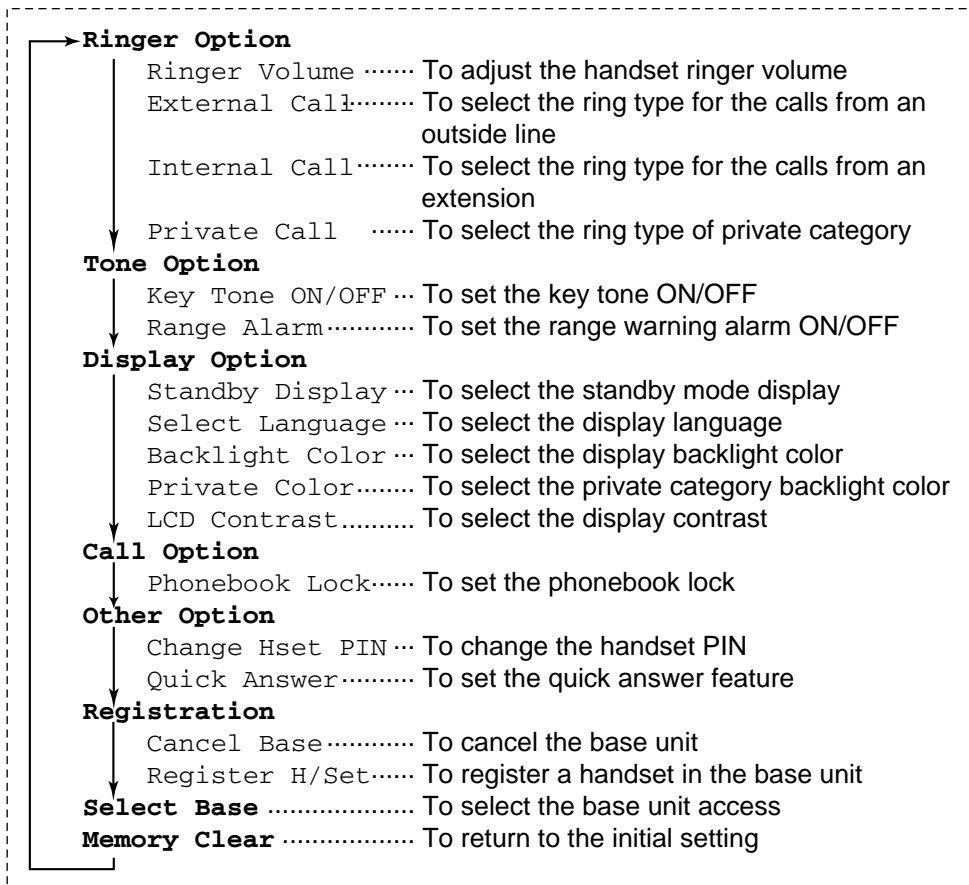



While Programming:

- You can press to go to the next menu of the function menu instead of pressing .
- To return to the previous step during programming, press or .
- You can exit the programming mode any time by pressing .
- When programming is completed, a beep sounds.

◆◆ To Change the Initial Settings

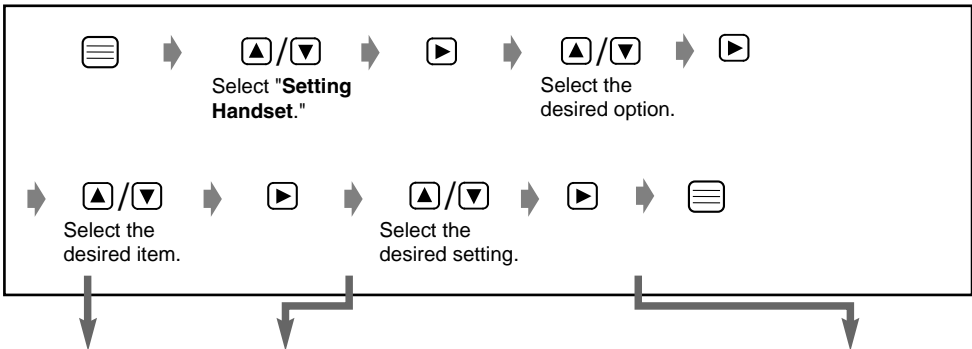

Option	Item	Description	Setting*1
Ringer Option	Ringer Volume	6 levels are available. When set to OFF, the handset will not ring.	<input type="checkbox"/> Level <input type="checkbox"/>
			<input checked="" type="checkbox"/> Level 3
			<input type="checkbox"/> OFF
	Ring Outside	You can select the ringer type for the calls from an outside line.	<input type="checkbox"/> Ringer no. <input type="checkbox"/>
			<input checked="" type="checkbox"/> Ringer 1 <input type="checkbox"/>
	Ring Internal	You can select the ringer type for the calls from an extension.	<input type="checkbox"/> Ringer no. <input type="checkbox"/>
<input checked="" type="checkbox"/> Ringer 3			



Option	Item	Description	Setting*1
Ringer Option	Private Call	You can select the handset ring type (20 types) for each private category.*2	<input type="checkbox"/> Ringer no. <input type="checkbox"/>
			<input checked="" type="checkbox"/> Ringer 1
Tone Option	Key Tone ON/OFF	You can turn on/off the handset key sound (key tone, confirmation tone, error tone).	<input type="checkbox"/> ON
			<input type="checkbox"/> OFF
	Range Alarm	You can turn on/off the range warning alarm.	<input type="checkbox"/> ON <input type="checkbox"/>
			<input type="checkbox"/> OFF <input type="checkbox"/>
Display Option	Standby Display	You can choose whether to display the currently connected base unit number, extension number or no display while in the standby mode.	<input type="checkbox"/> Base Number
			<input checked="" type="checkbox"/> Extn Number
			<input type="checkbox"/> OFF
	Select Language	You can choose one of 12 display languages.	<input type="checkbox"/> Language <input type="checkbox"/>
			<input checked="" type="checkbox"/> English
Backlight Color	You can set the display backlight colour to green, orange, or red.	<input type="checkbox"/> Green	
		<input type="checkbox"/> Orange	
		<input type="checkbox"/> Red	
Private Color	You can select the display backlight colour (red, orange, or green) for each private category.*2	<input checked="" type="checkbox"/> Green	
		<input type="checkbox"/> Orange	
		<input type="checkbox"/> Red	
LCD Contrast	You can select the display contrast level from 1 to 3.	<input type="checkbox"/> 1	
		<input checked="" type="checkbox"/> 2	
		<input type="checkbox"/> 3	



Option	Item	Description	Setting* ¹
Call Option	Phonebook Lock	You can prohibit anyone from entering the phonebook.* ³ When locked, you cannot dial from the phonebook.	<input type="checkbox"/> ON
			<input type="checkbox"/> OFF
Other Option	Change Hset PIN	You can programme a 4-digit handset PIN (Personal Identification Number). See p. 17 to set the PIN.	
	Quick Answer	You can answer a call by lifting the handset off the charger without pressing a button.	<input type="checkbox"/> ON <input type="checkbox"/> OFF
Registration	Cancel Base	For details, consult your dealer.	
	Register H/Set	For details, consult your dealer.	
Select Base		You can change the base unit (1-4).	<input type="checkbox"/> Base No. <input type="checkbox"/>
			<input type="checkbox"/> Auto (All connected terminals)
Memory Clear		You can clear the settings on the handset. They will return to their initial settings.* ³	<input type="checkbox"/> YES
			<input type="checkbox"/> NO

*¹ The initial setting is in gray.

*² You must choose the desired private category.

*³ You must enter the handset PIN.



◆ Setting the PIN

In the "Setting Handset" mode



old PIN



new PIN

Select "**Other
Option.**"

Select "**Change
Hset PIN.**"

Enter the current
4-digit handset
PIN.

Enter the new
4-digit PIN
TWICE.

Important Information

Battery Information

After your Panasonic batteries are fully charged:

Operation	Approx. Ni-MH battery life
While in use (Talk)	Up to 15 hours
While not in use (Standby)	Up to 150 hours

- Battery life may be shortened depending on usage conditions, such as:
 - when talking in speakerphone mode, using headset and ambient temperature.
- **Clean the handset and the charger contacts with a soft, dry cloth once a month. Clean more often if the unit is subject to grease, dust or high humidity.** Otherwise the batteries may not charge properly.
- The batteries cannot be overcharged.
- Read "Important Notice Concerning the Correct Use and Charging of Ni-MH Batteries."

◆◆ Replacing the Batteries

If "▣▣" flashes after a few telephone calls even when the handset batteries have been fully charged, it is time to replace the batteries with new ones (p. 2).

Before replacing the batteries, turn the power off to prevent memory loss (p. 3). Make sure you charge the new batteries for about 15 hours in order to display the battery strength prompt correctly.

◆◆ Caution:

To reduce the risk of fire or injury to persons, read and follow these instructions.

1. Use only the batteries specified.
2. Do not use non-rechargeable batteries.
3. Do not mix old and new batteries.
4. Do not dispose of the batteries in a fire. They may explode. Check with local waste management codes for special disposal instructions.
5. Do not open or mutilate the batteries. Released electrolyte is corrosive and may cause burns or injury to the eyes or skin. The electrolyte may be toxic if swallowed.
6. Exercise care in handling the batteries in order not to short the batteries with conductive materials such as rings, bracelets, and keys. The batteries and/or conductor may overheat and cause burns.
7. Charge the batteries provided with or identified for use with this product only in accordance with the instructions and limitations specified in this manual.

◆◆ Important Notice Concerning the Correct Use and Charging of Ni-MH Batteries

Batteries, due to their construction, undergo some wear and tear. The lifetime of a battery also depends on correct maintenance. Charging and discharging are the most important factors. You should take notice of the following to maintain the life of the battery as long as possible. Ni-MH batteries have a kind of memory, the "memory effect." If fully charged batteries are used several times only for 15 minutes in the handset and then recharged, the capacity of the batteries will be reduced to 15 minutes due to the memory effect. Therefore you should discharge the batteries completely, i.e. use them in the handset until "▣▣" on the display starts flashing. Then recharge them as described in the manual. After the memory effect has occurred, it is possible to achieve almost complete capacity of the Ni-MH batteries by charging and discharging several times one after another.



Ni-MH batteries can also self-discharge. This self-discharge depends on the ambient temperature. At temperatures under 0°C, the self-discharge will be the lowest. High humidity and high temperatures support the self-discharge. Also long-term storage will lead to self-discharge. A dead Ni-MH battery should not be disposed of normally. They contain toxic heavy metal hydride and therefore should be recycled.

Pay special attention to the safety suggestions listed below.

Safety

- 1) Power source: The AC adaptor should be connected to a power supply only of the type as marked on the AC adaptor.
- 2) Non use periods: When the Handset is not being used, turn the power off. When left unused for a long period of time, the charger should be unplugged from the household AC outlet.

Installations

Environment

- 1) Water and moisture: Do not use the Handset and the charger near water—for example, near a bathtub, washbowl, sink, etc. Damp basements should also be avoided.
- 2) Heat: The Handset and the charger should be kept away from heat sources such as radiators, kitchen ranges, etc. They also should not be placed in rooms where the temperature is less than 5 °C or greater than 40 °C.

Placement

- 1) Stacking: Do not place heavy objects on top of the Handset and the charger.
- 2) Foreign material: Care should be taken so that objects do not fall onto and liquids are not spilled into the Handset and charger. Do not subject the Handset and charger to excessive smoke, dust, mechanical vibration, or shock.
- 3) Surface: Place the charger on a flat surface. If the charger is mounted on the wall, install it straight.

For Best Performance

Operating Range

- 1) The range of operation depends on the topography of your office, weather or usage conditions, because signals are transmitted between the Cell Station (CS) and the Handset by radio waves.
- 2) Normally, you get greater range outdoors than indoors. If there are obstacles such as walls, noise may interfere with your telephone calls. In particular, high metal shelves or reinforced concrete walls will restrict your operating range.
- 3) A Handset may not work when it is too far from the CS depending on the structure of the building.

Noise

Occasional noise or interference may occur due to electromagnetic radiation from objects such as refrigerators, microwave ovens, faxes, TVs, radios, or personal computers. If noise disturbs your telephone calls, keep the Handset away from these electrical appliances.

WARNING:

TO PREVENT THE RISK OF FIRE OR ELECTRIC SHOCK DO NOT EXPOSE THIS PRODUCT TO RAIN OR ANY OTHER TYPE OF MOISTURE.

TO REDUCE THE RISK OF ELECTRIC SHOCK, DO NOT DISASSEMBLE THIS UNIT. TAKE THE UNIT TO AN AUTHORISED SERVICE CENTER WHEN SERVICE IS REQUIRED.

Specifications

Radio Access Method:	Multi Carrier TDMA-TDD
Frequency Band:	1,880-1,900 MHz
Number of Carriers:	10
Carrier Spacing:	1,728 kHz
Channel spacing:	1,728 kHz
Bit rate:	1,152 kbps
Carrier Multiplex:	TDMA, 24 (Tx12, Rx12) slots per frame
Frame Length:	10 msec
Modulation:	GFSK
Voice Coding:	32 kbps ADPCM (CCITT G.721)
Transmission Output:	Max. 250 mW

- Specifications are subject to change.
- The illustrations used in this manual may slightly differ from the original device.

CE0682

This device is a DECT Portable station operating in the frequency band of 1880 MHz to 1900 MHz.

This device complies with the requirements of the directive 1999/5/EC.

The usage of this device is generally allowed in all the EU countries.

Manufacturer:

Kyushu Matsushita Electric (U.K.) Ltd.

Pencarn Way, Duffryn, Newport, South Wales, NP10 8YE, United Kingdom

© Kyushu Matsushita Electric Co., Ltd. All Rights Reserved.

Printed in the United Kingdom

PSQX2470ZA

KK0301AH0

DUBUgcb]WHY`Yd\ cbY`GngHYa g



See More
Panasonic Manuals



www.voicesonic.com

Phone: 877-289-2829