

INSTRUCTION MANUAL

BK PRECISION[®]

MODEL 9130

Model 9130 Triple Output Programmable DC Power Supply



Safety information

Please review the following safety precautions before operating our equipment.

General information

The following safety precautions should be observed before using this product and any associated instrumentations.

This product is intended for use by qualified personnel who recognize shock hazards and are familiar with the safety precautions required to avoid possible injury. Read and follow all installation, operation, and maintenance information carefully before using the product. Refer to this manual for complete product specifications.

If the product is used in a manner not specified, the protection provided by the product may be impaired.

Before performing any maintenance, disconnect the line cord and all test cables.

Protection from electric shock

Operators of this instrument must be protected from electric shock at all times. The responsible body must ensure that operators are prevented access and/or insulated from every connection point. In some cases, connections must be exposed to potential human contact.

Under these circumstances personnel must be trained to protect themselves from the risk of electric shock. If the circuit is capable of operating at or above 1000 volts, no conductive part of the circuit may be exposed.

Definition of users

Responsible body is the individual or group responsible for the use and maintenance of equipment is operated within its specifications and operating limits, and for ensuring that operators are adequately trained.

This product should only be used as intended. Users must be trained in electrical safety procedures and proper use of the instrument. Users must be protected from electric shock and contact with hazardous live circuits.

Service is only to be performed by qualified service personnel.

Safety symbols and terms



Connect it to safety earth ground using the wire recommended in the user manual.



The symbol on an instrument indicates that the user should refer to the operating instructions located in the manual.



Complies with the essential requirements of the European directives.

Certification

We certify that this product met its published specifications at time of shipment from the factory.

TABLE OF CONTENTS

1. INTRODUCTION	5
2. QUICK START	6
2.1 Front & Rear Panel	6
2.2 Preliminary Checkout	7
3. SPECIFICATIONS	12
3.1 Specifications	12
3.2 Supplemental Characteristics	13
4. FRONT-PANEL OPERATION	14
4.1 Front-panel Operation Overview	14
4.2 Panel Description	15
4.3 VFD Description and Wiring Diagram	15
4.4 Menu Descriptions	16
4.5 Panel Operation	17
4.6 Menu Function.....	19
5. REMOTE OPERATION	24
5.1 Communication cable.....	24
5.2 Communication between Power Supply and PC.....	25
5.3 SCPI Command Overview	26
5.3.1 Common IEEE488.2 commands.....	26
5.3.2 Essential SCPI Commands	26
5.3.3 Nonstandard SCPI Commands	27
5.3.4 Simultaneous Control SCPI Commands (For firmware version 1.66 or above only).....	28
5.4 SCPI Command Description	30
5.4.1 SCPI Condition Register.....	30
5.4.2 SCPI Command Description.....	32
6. PV9130 SOFTWARE GUIDE	40
6.1 Introduction.....	40
6.2 Installation	40
6.3 PV9130 basics	40
6.3.1 Save and Open.....	42
6.3.2 Chart Description.....	42
6.3.3 Status bar	43
6.4 Operation.....	43
6.4.1 Configure the system.....	43
6.4.2 Setting Voltage and Current	44

6.5 Test sequence generation.....	44
6.5.1 Quickset.....	44
6.5.2 Program	45
6.5.2 Go/NG	45

1. Introduction

Description

The 9130 is a fully programmable triple Output DC Power Supply delivering 0-30V/0-3A on 2 outputs and 0-5V/0-3A on 1 output. Each output is fully floating and outputs can be adjusted independently or connected in series or parallel to produce higher voltages or currents. The front panel keys and the control knob provide a convenient means to adjust the voltage and current of a selected output; enable or disable parallel or series tracking mode; store and recall operating states or enable/disable individual outputs. The 9130 is ideally suited for applications in Electronic Test, Production and Service, where multiple independent DC supplies are required and bench space is at a premium.

Key Features

- 3 independent, fully programmable and electrically isolated outputs
- Series or parallel operation
- Display Voltage and Current for of all 3 channels simultaneously
- Over Current (OCP) and Over Temperature (OHT) protection
- Very compact foot print (2U x 1/2)
- Bright and easy to read display (VFD technology)
- High resolution, accuracy and stability
- Output on/off control
- Low ripple and low noise
- SCPI compatible command set, communicate via USB or RS232 port
- Application Software for front panel emulation and simple test sequence generation
- 50 memory locations for instrument state storage & recall
- Convenient data entry via knob or numerical key pad
- Rack mount kit available

2. Quick Start

This chapter will help you getting acquainted with the front panel operation of this power supply.

2.1 Front & Rear Panel

Front panel

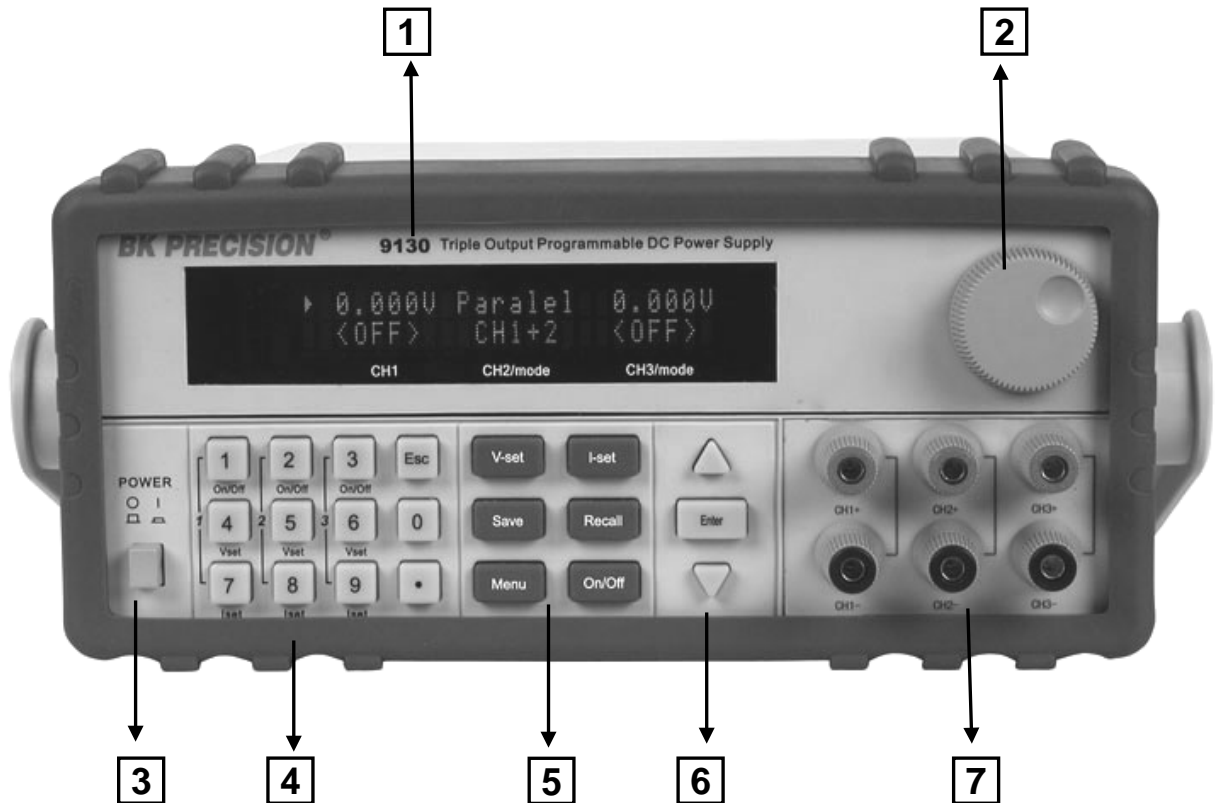

- 1** VFD display
- 2** Rotary knob
- 3** Main power switch
- 4** Numerical key pad and “Esc” key
- 5** Function keys
- 6** Cursor position & Channel Selection keys, “Enter” key
- 7** Output terminals

Rear Panel

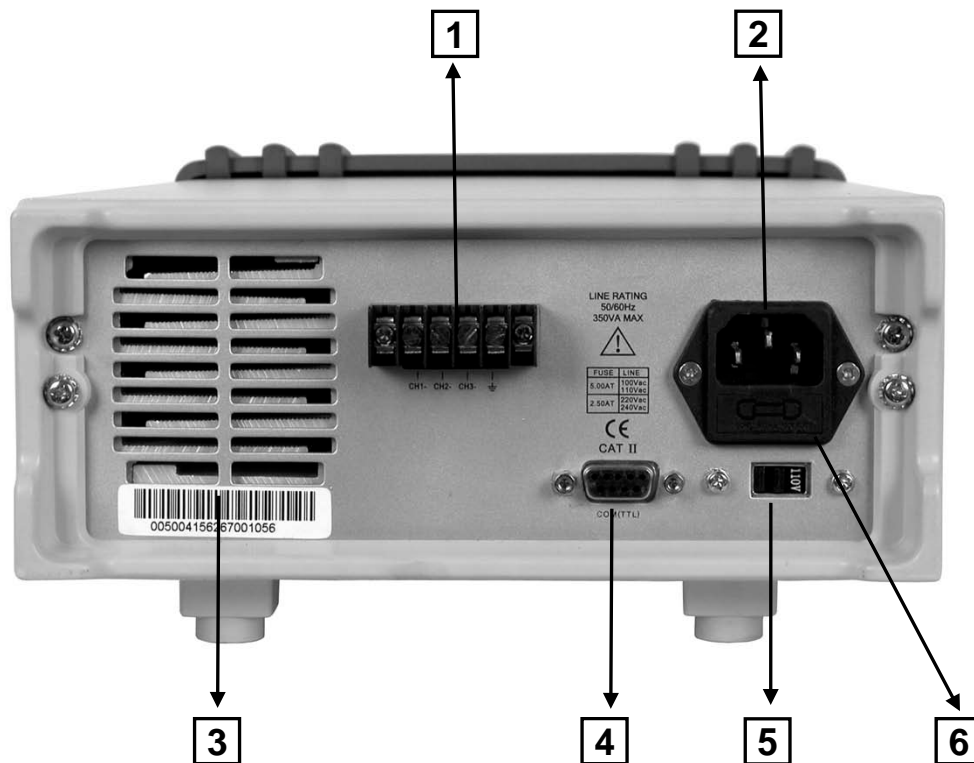

- 1) Terminal block for GND reference and additional negative output terminal
- 2) AC receptacle
- 3) Ventilation holes
- 4) Interface connector for remote control of power supply
- 5) 110V/220V AC Power selection switch
- 6) Fuse compartment

2.2 Preliminary Checkout

The following steps will help you verify that the power supply is ready for use.

1. Check the list of supplied items

Verify that you have received the following items with your power supply. If anything is missing, contact your authorized B+K Precision distributor.

- Power cord
- Instruction manual
- Calibration Report
- Communication cable
- Software installation disk

2. Connect the power cord and turn on the power supply

When you turn on the power supply, the front-panel display will light up briefly while the power supply performs its power-on self-test. All the VFD annunciators will turn on at once. Check for any missing display segments. In the event that there is no response when you turn on the power supply, refer to section 5 of this chapter for additional information.

3. System Checkout

At power up, the instrument will automatically perform a self test routine. During this time, the following should be displayed:

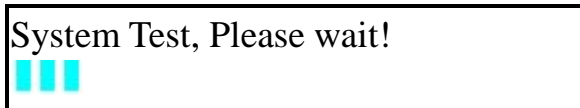

System Test, Please wait!

followed by

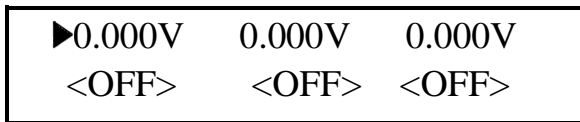

▶0.000V	0.000V	0.000V
<OFF>	<OFF>	<OFF>

Or:

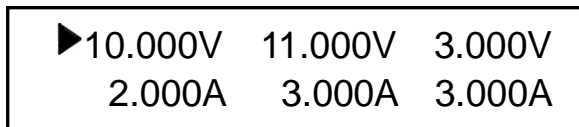

▶10.000V	11.000V	3.000V
2.000A	3.000A	3.000A

Note: The first row is the output voltage for channels 1 – 3. The second row will display the on/off state or the output current of each channel.

In case the self test routine is not successful, you may see one of the following:

If the EEPROM is damaged, the VFD will display the following:



EEPROM Error

If the last operation data which should be stored in the EEPROM was lost you should see



Data Check Error

If the latest data about off-time in EEPROM was lost, the VFD will display



Load Off Time Fail

If the calibration data stored in the EEPROM was lost, the VFD will display

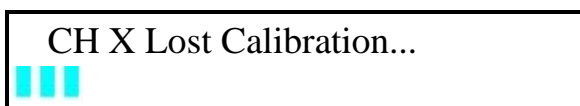

CH X Lost Calibration...

Note: “X” denotes the channel for which calibration data was lost.

If the calibration data in the EEPROM is corrupted or the factory calibration values are lost, the VFD will display the following:



Note: You will see a “?” on the VFD, in case of any errors are encountered during the self test routine.

4. Output Verification

The following procedures verify that the power supply outputs the correct voltage and current levels and properly responds to entries from the front panel.

- **Voltage Output Checkout**

The following steps verify basic voltage functions without load.

- 1) Turn on the power supply.
- 2) Turn on the outputs using the **On/Off** key
Note: Flashing voltage values indicates that the power supply is in “Set mode, “Set mode” means that the VFD display shows the set values for voltage and current. In “meter mode” the display will indicate the actual output voltage and current.
- 3) Check that the front-panel voltmeter properly responds to number key entries
Enter a different voltage value and wait a few seconds until the meter mode activates. Verify that the actual output value voltage is identical to the set value. Also verify that the displayed current value is close to zero.
- 4) Ensure that the voltage level can be adjusted from zero to the maximum rated value.
- 5) Verify channels 2 & 3 according to steps 1) – 4)

- **Current Output Current**

The following steps check basic current functions with a short across the power supply’s output.

- 6) Turn on the power supply
- 7) Turn the output off
Press **On/Off** key to ensure that the outputs are off. (bottom row indicates “OFF”)
- 8) Connect the (+) and (-) output terminals of channel 1 with a short, insulated test lead. Use a wire size sufficient to handle the maximum current.
- 9) Set the voltage value with 1V
- 10) Turn on the output using the **On/Off** key.
- 11) Adjust the current value
Enter a different current value, wait until the instrument is in meter mode, then make sure that the displayed current value (actual output value) is the same as the set value.
- 12) Ensure that the current can be adjusted from zero to the maximum rated value.
- 13) Turn off the power supply and remove the short wire from the output terminals.

14) Verify channels 2 & 3 according to steps 1) – 8)

5. If the Power Supply Does Not Turn On

Use the following steps to help resolve problems you might encounter when turning on the instrument.

1). Verify that there is AC power applied to the power supply.

Verify that the power cord is firmly plugged into the power receptacle on the rear panel of the power supply. Make sure the power outlet you are using is working properly and verify that the power supply is turned on.

2). Verify the power-line voltage setting.

Make sure the voltage selector switch is set according to the present line voltage (110VAC or 220VAC). Change the voltage setting if it's not correct.

3). Verify that the correct power-line fuse is installed.

Model	Fuse Description
9130	Fuse 3.15A T250V(220V AC)
	Fuse 6.30A T250V(110V AC)

If the fuse is blown replace it according to the table above.

6. To Adjust the Carrying Handle

To adjust the position, grasp the handle on each side and pull outwards, then rotate the handle to the desired position.

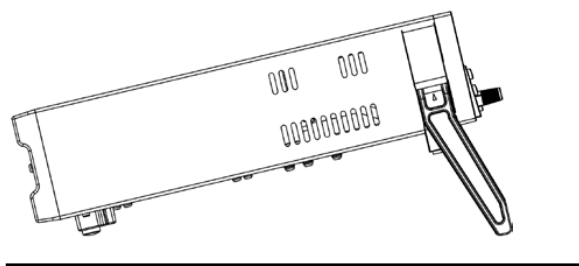
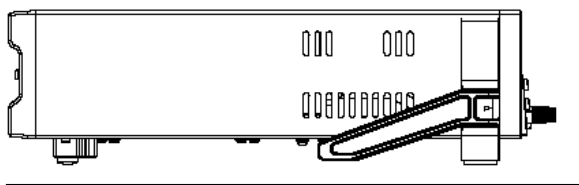

Bench-top viewing positions

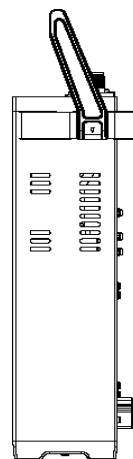

Carrying position

7. To Rack Mount the Instrument

You can mount the power supply in a standard 19-inch rack cabinet using the IT-E151 rack mount kit.

Note: Remove the carrying handle and the two plastic ears before rack-mounting the instrument. To remove the handle, grasp the handle on the side, pull outwards and rotate it to a special position where the

arrow on the handle and the arrow on the plastic ears are in opposite directions. Now you can pull the handle outwards. After removing the handle, you can remove the two plastic ears with a screw driver.

3. Specifications

3.1 Specifications

Parameter		9130
Output ratings	Voltage	0~30V×2, 0~5V×1
	Current	0~3A×2, 0~3A×1
	LVP*	0~31V×2, 0~6V×1
Load Regulation ±(% of output+offset)	Voltage	≤0.01%+3mV
	Current	≤0.1%+3mA
Line Regulation ±(% of output+offset)	Voltage	≤0.01%+3mV
	Current	≤0.1%+3mA
Programming Resolution	Voltage	1mV
	Current	1mA
Readback Resolution	Voltage	1mV
	Current	1mA
Programming accuracy (12 months) ±(% of output+offset)	Voltage	≤0.03%+10mV
	Current	≤0.1%+5mA
Readback accuracy (25 °C ± 5 °C) ±(% of output+offset)	Voltage	≤0.03%+10mV
	Current	≤0.1%+5mA
Ripple & noise	Voltage	Ripple: ≤1mVrms/3mVp-p
		Noise: ≤3mVrms
Transient Response	Time	< 500 μs for CH1&2, < 200 μs for CH3 for output to recover to within 75 mV following a change from 100 mA to 1 A
Temperature coefficient (0 °C ~ 40 °C) ±(% of output+offset)	Voltage	≤0.03%+10mV
	Current	≤0.1%+5mA
Readback Temperature Coefficient ±(% of output+offset)	Voltage	≤0.03%+10mV
	Current	≤0.1%+5mA
Tracking Accuracy Series Operation	Current	≤0.05%+10mA
Tracking Accuracy Parallel Operation	Voltage	≤0.02%+5mV
	Current	≤0.1%+20mA
Output Timer	Time set	1s~999999s
	Resolution	1s
Weight		19.8 lbs, (9 kg)
Dimensions		214.5mm(W) × 88.2mm (H) × 354.6mm (D)

		8.45in(W) x 3.8in(H) x 13.9in(D)
--	--	----------------------------------

*) LVP: Limit Voltage Protection. Limits the voltage than can be set either via the front panel or remote control command.

NOTE: Specifications and information are subject to change without notice. Please visit www.bkprecision.com for the most current product information.

3.2 Supplemental Characteristics

State Storage Memory

50 user-configurable stored states

Recommended Calibration Interval

1 year

AC Input Ratings (selectable via switch on the rear panel)

220AV±10%, 47□ 63Hz

110AV±10% □ 47□ 63Hz

Maximum power consumption

Model	9130
Power	750VA

Cooling

Fan cooled

Operating Temperature

0 to 40 °C for max rated output

Storage Temperature

-20 to 70 °C for storage environment.

Environmental Conditions



Designed for indoor use in an installation category II, pollution degree 2 environment. Designed to operate at maximum relative humidity of 95% and at altitudes of up to 2000 meters.



4. Front-panel Operation

So far we have covered the quick start chapter which briefly introduced the front panel operation and how to check basic voltage and current functionality. This chapter describes in detail how to operate the instrument manually via the front-panel keys.

4.1 Front-panel Operation Overview

- The power supply is shipped from the factory ready for front-panel operation mode. At power-on, the power supply will automatically enter the front-panel operation mode and the instrument can be controlled via the front panel keys and knob.

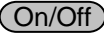
The power supply enters remote mode as soon as a valid remote command is received via the communication connector in the rear. Switching to remote mode does not impact the supply's output parameters. In remote mode, front-panel operation is disabled. If the power supply is in remote mode, and the [LOCAL] key  is not disabled, you can revert to manual mode by pressing the [LOCAL] key .

- The power supply is in Meter mode when it is powered on. In this mode, the VFD will display the actual voltage and current output value. If the user adjusts the knob while in this mode, the power supply will automatically enter Set mode then revert back to meter mode and display the modified voltage and current values.
- The output of the power supply can be enabled/disabled from the front panel by pressing the  key.
- The VFD also displays operation states or error information. “” means the power supply is in remote mode. If an error occurred, “?” will be displayed.
- If the power supply is in Set mode, you can modify parameters using the knob. If the power supply is in menu operation, the knob is used for menu selection. If the power supply is in the regular output mode you can use the knob to set the voltage value.
- If “?” is displayed on the VFD, please consult the submenu “error information” for more details (see chapter 4.4).

4.2 Panel Description

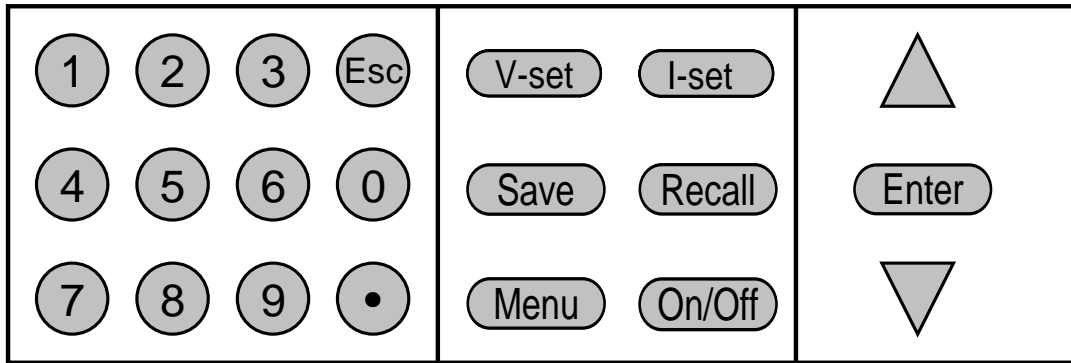

0~9	Use keys 1~3 to control the output state of the 3 channels □ Use keys 4~6 to set the voltage and keys 7~9 to set the current value for each channel.
V-set	Set the voltage value
I-set	Set the current value
Save	Save the current setup of the power supply to internal memory
Recall	Recall the setup from internal memory
Menu	Set general parameters of the power supply
On/Off	Set the output state of the power supply
	Up arrow key, select a menu or channel
	Down arrow key, select a menu or a channel

4.3 VFD Description and Wiring Diagram

Explanation of annunciators on the display

OFF	The output is off.
	The key panel is locked.
	The power supply is in remote mode.
?	There is some error or fault with the power supply.
	Indicates the channel currently selected

4.4 Menu Descriptions

Press **Menu** to indicate operation mode. View the menu on the VFD, and use the Δ ∇ keys or the knob to scroll through the complete menu listed below. Press **Enter** to enter the selected menu function, press **Esc** to return to the previous menu. A ” \updownarrow ” symbol displayed on the left means that you are currently in the middle of a menu and you can now use the Δ ∇ keys to select other menu parameter. If there is only ” \up ” displayed, you are at the end of the currently active menu and you can only press the Δ key to select a different parameter. Accordingly, ” \downarrow ” indicated that you can use the ∇ key to select another parameter. Symbols \blacktriangleright \blacktriangleleft enclose the currently selected menu.

Menu		
Power Config...		
	Reset Config	System reset
	Out State Set	“Remember” Output On/Off state before power off
	Out Parameter Set	“Remember” parameters before power off
	Key Sound Set	
	Knob Function Set	Enable/disable knob
	Screen Brightness	
	Baud Rate Set	Set baud rate
	Communication Parity	
	System Wait Time	determines duration of set mode
	Local Address	Set communication address
	Key Lock Set	Set password
	Exit	
System Set...		
	Out Series Set	Configure for series operation
	Out Parallel Set	Configure for parallel operation
	Max Voltage Set...	Set the max. voltage for each channel (LVP)
	Set First Channel	
	Set Second Channel	
	Set Third Channel	
	Out Time Set...	Set output time for each channel
	Set First Channel	
	Set Second Channel	
	Set Third Channel	
	Exit	
Power Information...		
	Power Model	Display the power rating

	Power SN	display the serial number
	Soft Version	Display the firmware version
	Cal Information	
	Error Information	
	Exit	
Exit Menu		

4.5 Panel Operation

Channel Operation

When the power supply is in “METER” mode, you can select a channel using the arrow keys Δ ∇ .

OUT ON/OFF

Pressing On/Off toggles the output state of all 3 channels of the power supply. If the output state is ON, press it, to turn the output state to OFF. While the output state is OFF, press On/Off and the power supply output will turn ON.

To control channels individually, press one of the number keys $\textcircled{1}$, $\textcircled{2}$, $\textcircled{3}$ corresponding to each channel.

Key $\textcircled{1}$ controls the output state of the first channel, key $\textcircled{2}$ controls the output state of the second channel and key $\textcircled{3}$ controls the output state of the third channel.

When the power supply is in remote mode, you can set the output state by sending SCPI command (OUTPUT: ON | OFF). The Output state operation doesn't affect any other parameter.

Note: The On/Off key controls the output state of all 3 channels simultaneously.

If you want to control the output state of individual channels, use the number keys 1-3.

Timer Operation

If you have set the output timer and the power supply is in “METER” mode, you can check the remaining time by pressing $\textcircled{0}$. When the timer expires, the power supply will turn off the channel automatically.

Set Voltage

Solution 1: Press V-set , enter a numeric value (via key pad) then press Enter to confirm.

Solution 2: Press **V-set**, then use the arrow keys $\Delta \nabla$ to move the cursor to the desired position and adjust the value with the knob. (Make sure the knob function is enabled in the systems menu,, otherwise use solution 1). Press **Esc** or **Enter** to return to meter mode. (Otherwise the cursor will remain visible indefinitely or until the system Wait time timer expires).

Solution 3: Press one of the keys 4-6, corresponding to the channel which you want to adjust (Press **4** to adjust the first channel, press **5** to control the second channel and press **6** to control the third channel).

For example, to set voltage for the first channel: Press **4**, then enter a numerical value followed by **Enter**. Alternatively, press $\Delta \nabla$ to move the cursor adjust the voltage value using the knob. Press **Esc** or **Enter** to escape and return to meter mode.

Set Current

Solution 1: Press **I-set**, enter a numeric value then press **Enter** to confirm.

Solution 2: Press **I-set**, the press $\Delta \nabla$ to move the cursor position and adjust the voltage value using the knob. (Make sure the knob function is enabled in the systems menu,, otherwise use solution 1). Press **Esc** or **Enter** to exit.

Solution 3: Press one of the number keys 7 – 9 corresponding to the channel for which you want to set the current value. (Press key **7** to control the first channel, **8** for the second channel or press key **9** to control the third channel). For example, if you want to set the current for the first channel, press key **7**, then enter a numeric value followed by the **Enter** key. Alternatively, or press $\Delta \nabla$ to move the cursor and adjust the value with the knob. Press **Esc** or **Enter** to escape and return to meter mode. (Otherwise the cursor will remain visible indefinitely or until the system Wait time timer expires).

Save and Recall Operation

You can store up to 50 different operating states in memory locations 1 through 50. Each operating state includes a constant voltage value, constant current value, maximum output voltage value and voltage step value. Press **Save** followed by a number key to save the current operating state to non volatile memory.

Press **Recall** followed by a number 1 – 50 to recall operating state assigned to this location.

You can also use the SCPI command: *SAV、 *RCL to save and recall.

Over Temperature Protection

If the internal temperature of the power supply exceeds 80 °C, the instrument will protect itself by automatically turning power OFF. When this happens you will hear a buzzer and the display will indicate the following:

Over Temp

4.6 Menu Function

In menu operation, the Δ ∇ keys or the knob can be used to select the menu. **Enter** is used to confirm a selection. The **Esc** key is used to exit the current menu

- **Power Config**

Reset Config

If you enter this menu and select “YES”, all parameters will be set to their default values.

Out State Set

This parameter sets the Output On/Off state at power up. If you select “Last Set”, the power supply will save the output state prior to power down and revert to that state at power up. If you select “Off”, the output state is always “OFF” when the power supply is turned on. The recommend setting is “OFF”.

If Out Parameter Set is set to “Default”, the output state of the power supply after power –up will always be off, regardless of the settings of this parameter

Out Parameter Set

This parameter determines the state of the power supply after power up. If you select “Last Set”, the power supply will automatically restore (“remember”) the last output parameters setting prior to power down. If you select “default”, the default output parameter settings will be active after power up. Recommend setting is “Last Set”.

Key Sound set

This parameter turns the beep sound for key presses “On” or “Off”.

Knob Function Set

This parameter enables (“On”) or disables (“Off”) the knob.

Baud Rate Set

This parameter configures the baud rate for serial communication. Possible values are 4800, 9600, 19200 or 38400. When operating the power supply in remote mode, make sure that you configure identical baud rate settings for the power supply and the computer. The default setting is 9600.

Communication Parity

This parameter sets the parity bit for serial communication. Possible values are NONE, ODD and EVEN. Default setting is NONE.

System Wait Time

This parameter determines how long the power supply will remain in set mode until it automatically reverts back to meter mode or output mode. The minimum is 4 seconds, and the maximum is 9999 seconds. Enter a numerical value followed by **Enter** or press $\Delta \nabla$ + **Enter** to set the wait-time. To disable the system wait time function, set the wait time to 0 seconds. (In this case, the power supply will remain in set mode until the ESC or ENTER key is pressed). Set mode is active when a cursor is visible. Default setting is 0 seconds.

Note: the wait-time range is 4~9999S, if you set it with 1~3S, the wait-time will be 4S automatically.

Local Address

With this parameter, it is possible to address each instrument. The address range is 0 to 30.

Key Lock Set

A password can be assigned (1 - 4 digits) to lock the function key operation. After setting the password, there is a sign  displayed on the VFD and all the function keys on the front panel will be locked except of the **On/Off** key (if the knob is enabled, $\Delta \nabla$ keys can also be used). You must enter the correct password to unlock the keys. If you don't want to lock the function keys, please set the password to 0 when entering the >SET KEYLOCK function.

When the knob function is enabled:

You can press the $\Delta \nabla$ keys to move the cursor position, then enter a number and press **Enter** to set the password. Or press $\Delta \nabla$ to select the cursor position and change the value using the password using the knob. Press + **Esc** or **Enter** to exit.

When the knob function is disabled:

Press number key + **Enter** to set the password or use the $\Delta \nabla$ keys.

- **System Set**

Out Series Set

This function configures the instrument for series operation of 2 channels. “None” means that each channel operates independently (power supply not in series mode). “1+2” means that channel 1 and channel 2 operate in series, 1+3 means that channel 1 and channel 3 operate in series.

Note: Channels 2 and 3 can NOT be configured for series operation.

Connection diagram example: Channels 1 and 2 connected in series

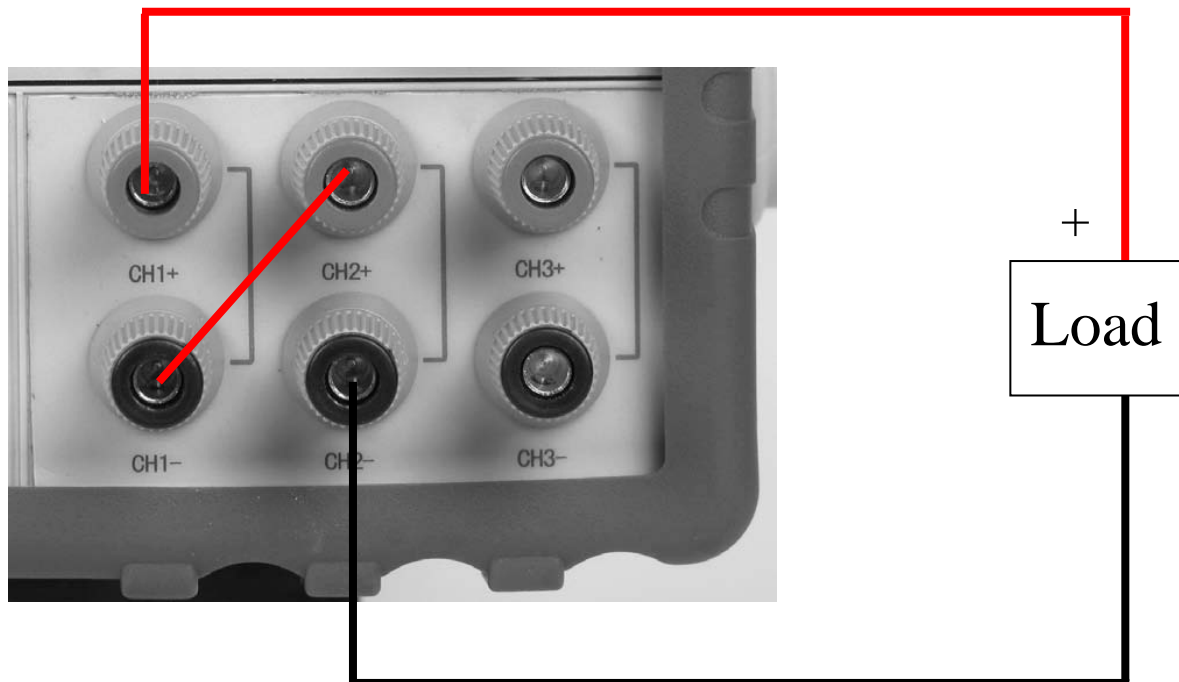

Out Parallel Set

This function configures the instrument for parallel operation. “None” means that each channel operates independently. “1+2” means that channel 1 and channel 2 operate in parallel, “1+3” and 2+3 means that channels 1 and 3 or channels 2 and 3 respectively operate in parallel. ALL indicates that all 3 channels operate in parallel.

Note: The output state of all channels will automatically be set to OFF and the voltage value will be 0V after configuring the instrument for series or parallel operation, therefore you have to set the parameter again after reconfiguration.

Connection diagram example: Channels 1 and 2 connected in parallel

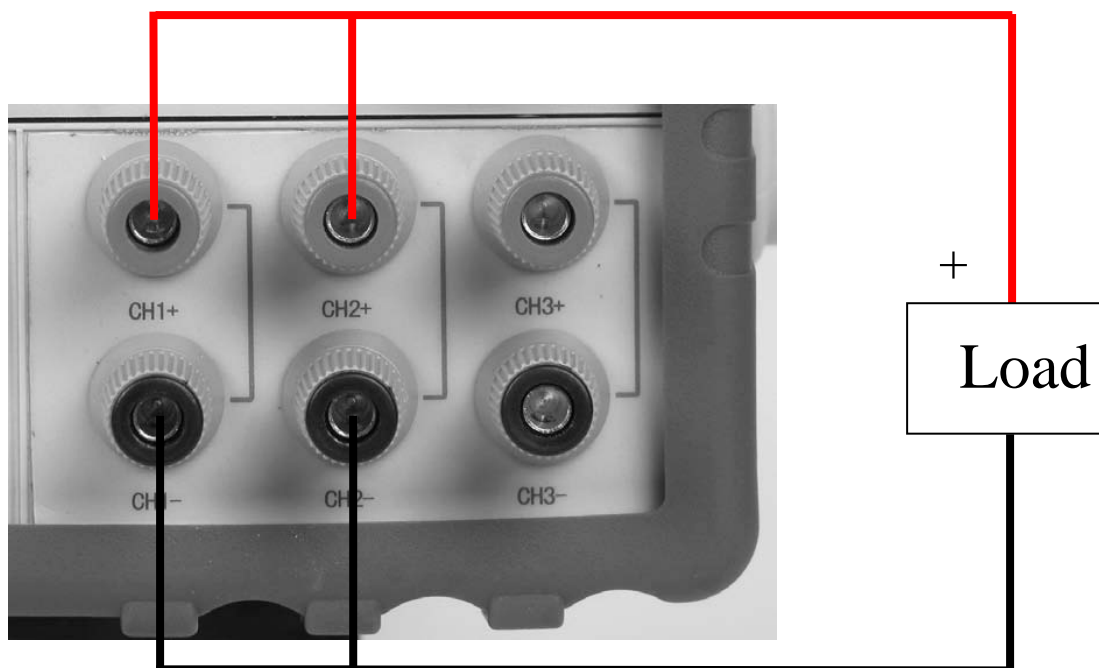

Note: When configuring for series or parallel operation, the user must wire the terminals to match the configuration. The power supply does not automatically connect the appropriate terminals internally based on the configuration selected.

MaxVolt Set (LVP)

The max voltage you set should be within the range of 0V to the maximum rated voltage. You can edit this value using the Δ ∇ keys or via numerical key pad followed by **Enter**. The default setting is the maximum rated voltage for each channel.

Out Time Set

This parameter sets the output timer for each channel. The range is 1~999999 seconds. If you enable this function, and the output state of all channels is on, the timer will start counting down immediately. Once the timer expires (count down from set value to zero) the output of the assigned channel will turn off. To disable the timer, set the output time to zero.(0 seconds). Default setting is 0 Seconds.

- **Power Information**

The following menus provide information about the specific power supply unit.

Power Model: the model of power supply

For example: 30V, 3A*2CH 5V, 3A*1CH

Power SN: the serial number

For example: 001001156074001165

Soft Version: the version number of the power supply

For example: Soft Version=1.00

Cal Information: calibration information of the power supply (last calibration date)

For example: 2005-8-26 17:46:13

Error Information: error information of power supply

For example: 0, No Error

Exit Menu

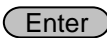
Note: after the error information has been displayed, you can press  or  to exit. Afterwards the error information will be cleared out although the error condition still exists. Consult the table below for an explanation of error codes.

0	'No Error'	There is no error.
1	'Too Many Num Suf'	The number in the ROM is too many to deal with.
10	'No Command'	The command is invalid.
14	'Num Suf Invalid'	The subscript of the number is invalid.
16	'Invalid Number'	The number is invalid.
17	'Invalid Dims'	The data dimension is invalid.
20	'Param Overflow'	Parameter overflow.
30	'Error Para Units'	Parameter unit error.
40	'Error Para Type'	Parameter type error.
50	'Error Para Count'	Parameter count error.
60	'Unmatched Quote'	The sign quoted by parameter is unmatched.
65	'Unmatched Bracket'	The bracket doesn't match the parameter.
70	'Invalid Command'	The command is invalid.
80	'No Entry'	Command entry can not be found.
90	'Too Many Dims'	Too many data dimension.
100	'Too Many Command'	Too many commands.
101	'Command Exec Err'	An error occurred during command execution.
110	'Error Rxd Parity'	
120	'Error EEPROM'	There is error when checking the EEPROM.
121	'Error Config Data'	Configuration data error.
122	'Error Cal. Data'	Calibration data error.
123	'Error Factory Data'	Calibration data supplied by factory is error.

5. Remote Operation

The DB9 interface connector on the rear panel of the power supply can be connected to a RS-232 or USB interface via the included adapter cable. This chapter describes how to use a computer to control the output of the power supply.

5.1 Communication cable

RS232 Communication cable IT-E131

The DB9 interface connector on the rear panel of the power supply provides a TTL voltage level interface. Use the communication cable (IT-E131) to connect the DB9 interface connector of the power supply to the RS-232 interface connector of the computer

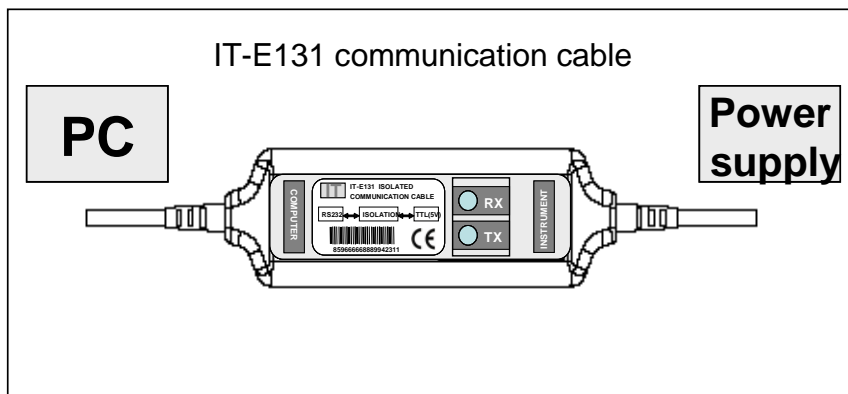

Note: It is **not possible** to connect the DB9 connector of the power supply directly to a PC's RS232 or USB port.

USB Communication cable IT-E132

The DB9 interface connector on the rear panel of the power supply provides a TTL voltage level interface. Use the communication cable (IT-E132) to connect the DB9 interface connector of the power supply to the USB interface connector of the computer.

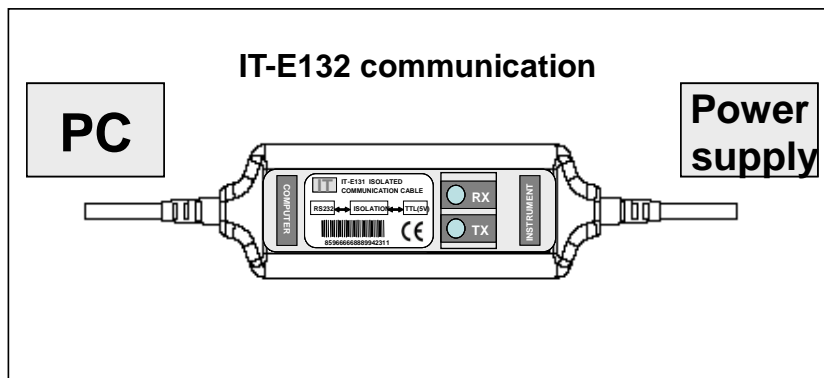

Note: Before you can use the USB communication cable, you must install the USB driver which can be found on the included installation disk.

5.2 Communication between Power Supply and PC

Before putting the instrument into remote operation, make sure that the baud rate, parity bit and communication address settings on the power supply and computer side are identical, otherwise communication will not be possible.

1. Address Range is 0 to 30. Default setting is 0.
2. Baud rate: 4800,9600,19200 and 38400 are selectable, default setting is 9600
3. Parity and Data bits: None/8 bits (default setting)
 Even/8 bits
 Odd/8 bits
4. Stop bits: 1 (fixed)
5. Start Bits: 1 (fixed)

Data Frame Format

Parity=None	Start Bit	8 Data Bits	Stop Bit
-------------	-----------	-------------	----------

Parity=Odd, Even	Start Bit	8 Data Bits	Parity Bit	Stop Bit
---------------------	-----------	-------------	------------	----------

End of String character is '\n' (0x0a)

DB9 Interface Details

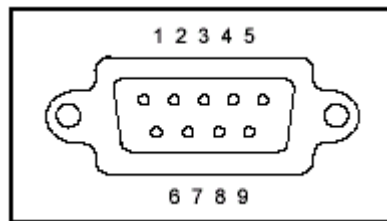

The DB9 connector in the rear panel of the power supply provides a TTL level signal .It can be connected to a standard PC interface via the IT-E131 or IT-E132 isolated communication cable.

Note: Setting of the address is optional. It is not required to communicate with the instrument. The address can be set from the front panel and is stored in non volatile memory. This feature is useful when connecting several instruments, e.g. via USB hub. In this scenario, Windows assigns a virtual COM port to each device which is unknown prior to establishing communications with the instrument (could be different each time). In this case, the address will allow the user to correlate each virtual COM port with the address assigned to each instrument.

5.3 SCPI Command Overview

5.3.1 Common IEEE488.2 commands

*CLS
*ESE
*ESE?
*ESR?
*IDN?
*OPC
*OPC?
*PSC
*PSC?
*RST
*SRE
*SRE?
*STB?
*SAV
*RCL

5.3.2 Essential SCPI Commands

SYSTem

:ERRor?
:VERSion?
:BEEPer[:IMMEDIATE]
:ADDRess?

STATus

:QUESTionable
 :ENABle <enable value>
 :ENABle?
 [:EVENT]?
 :CONDition?
:OPERation
 :ENABle <enable value>
 :ENABle?
 [:EVENT]?
 :CONDition?
 :INSTrumenU
 [:EVENT]?
 :ENABle <value>
 :ENABle?

CONDition?

INSTrument

[:SELEct] {FIRst|SECOnd|THIrd}
[:SELEct]?
NSELEct {1|2|3}
NSELEct?

OUTPut

[:STATe] {0|1}
[:STATe]?

[SOURce:]

CURRent[:LEVel][:IMMediate][:AMPLitude] {<current>|MIN|MAX}
CURRent[:LEVel][:IMMediate][:AMPLitude]? {MIN|MAX}
VOLTage[:LEVel][:IMMediate][:AMPLitude] {<voltage>|MIN|MAX}
VOLTage[:LEVel][:IMMediate][:AMPLitude]? {MIN|MAX}
VOLTage:PROTection[:LEVel][:IMMediate][:AMPLitude]
VOLTage:PROTection[:LEVel][:IMMediate][:AMPLitude]?

5.3.3 Nonstandard SCPI Commands

CALibration

:SECure[:STATe] {ON|OFF,<quoted code>}
:SECure[:STATe]?
:VOLTage
 LEVel <level>
 [:DATA] <voltage value>
:CURRent
 LEVel <level>
 [:DATA] <current value>
:CODE
:SAVe
:INITial

OUTPut

:TIMer
 :DATA <time>
 :DATA?

SYSTem

:LOCal
:REMote

:RWLock

DISPlay:

[:WINDow][:STATe] {OFF|ON}

[:WINDow][:STATe]?

MEASure[:SCALer]

:CURRent[:DC]?

[:VOLTage][:DC]?

:POWer[:DC]?

5.3.4 Simultaneous Control SCPI Commands (For firmware version 1.66 or above only)

This section describes additional SCPI commands available for controlling parameters of all three channels simultaneously without having to select each channel one at a time prior to setting their respective parameters.

NOTE: These commands are **ONLY** available for 9130 supplies with firmware version 1.66 or above. They are not available for firmware versions below 1.66.

APPly:VOLTage[:LEVel][:IMMediate][:AMPLitude]

This command is used to set the 3 channels' voltage at the same time.

Parameter type: three channels' voltage setting value.

You can set the 1st, 2nd, and 3rd channels in one string.

Returned value: none.

Example: APP:VOLT 1,2,3 (set CH1, CH2, CH3 voltages as 1V,2V,3V respectively)

APPly:VOLTage[:LEVel][:IMMediate][:AMPLitude]?

This command is used to read out the 3 channels' voltage setting value at the same time.

Parameter type:none

Returned value: The voltage setting value of the 3 channels.

Example: APP:VOLT?

APPly:CURRent[:LEVel][:IMMediate][:AMPLitude]

This command is used to set the 3 channels' current at the same time.

Parameter type: three channels' current setting value.

You can set the 1st, 2nd, and 3rd channels in one string.

Returned value: none.

Example: APP:CURR 1,2,3 (set CH1, CH2, CH3 current as 1A,2A,3A respectively)

APPLY:CURRENT[:LEVEL][:IMMEDIATE][:AMPLITUDE]?

This command is used to read out the 3 channels' current setting value at the same time.

Parameter type: none

Returned value: The 3 channels' current setting value.

Example: APP:CURRE?

APPLY:PROTVOLTAGE[:LEVEL][:IMMEDIATE][:AMPLITUDE]

This command is used to set the max voltage of the 3 channels at the same time.

Parameter type: 3 channels' max voltage setting value.

You can set the 1st, 2nd, and 3rd channels in one string.

Returned value: none

Example: APP:PROT 1,2,3 (set CH1, CH2, CH3 max. voltages as 1V,2V,3V respectively)

APPLY:PROTVOLTAGE[:LEVEL][:IMMEDIATE][:AMPLITUDE]?

This command is used to read out the 3 channels' max voltage at the same time.

Parameter type: none

Returned value: The 3 channels' max voltage value.

Example: APP:PROT?

APPLY:OUT[:STATE]

This command is used to control the 3 channels' ON/OFF status at the same time.

Parameter type: 0|1|ON|OFF

Returned value: none

Example: APP:OUT ON, OFF, ON

APP:OUT 1,0,1 (Set CH1, CH2, CH3 output to ON, OFF, ON respectively)

APPLY:OUT[:STATE]?

This command is used to read out the 3 channels ON/OFF status at the same time.

Parameter type: none

Returned value: 0|1|ON|OFF

Example: APP:OUT?

MEASURE:SCALAR:VOLTAGE:ALL[:DC]?

This command is used to read out the measured output voltage value of the 3 channels simultaneously.

Parameter type: none

Returned value: 3 channels' actual measured output voltage

Example: MEAS:VOLT:ALL?

MEASURE:SCALAR:CURRENT:ALL[:DC]?

This command is used to read out the measured output current value of the 3 channels simultaneously.

Parameter type: none

Returned value: 3 channels' actual measured output current

Example: MEAS:CURRE:ALL?

MEASure[:SCALar]:POWER:ALL[:DC]?

This command is used to read out the measured output power value of the 3 channels simultaneously.

Parameter type: none

Returned value: 3 channels' actual measured output power

Example: MEAS:POW:ALL?

5.4 SCPI Command Description

5.4.1 SCPI Condition Register

You can obtain the state of the power supply and read parameters from the operation register. The different states of the power supply can be read from 7 condition registers. These registers are status byte register, standard event register, quest condition register and operation status register. The status byte register stores the information of 3 other registers. The following table provides the details on each register's meaning.

	bit	code	meaning
Operation status sub register	0	CAL	The power supply is calculating new calibration parameters.
	1	UNR	The status of the power supply is unregulated.
	2	CV	The power supply is in constant voltage condition.
	3	CC	The power supply is in constant current condition.
	4	RI	Not used
Quest condition register	0	OV	Not used
	1	OT	Over temperature
Standard event register	0	OPC	Operation of power supply is completed.
	2	QYE	Query error. Data of output array is missing.
	3	DDE	Device-dependent error. Data stored in register is missing or error occurs in preliminary checkout.
	4	EXE	Execution error. Command parameter overflows or the condition is not right.
	5	CME	Command error. Syntax or semantic error occurs when receiving information.
	7	PON	Power on. It is 1 when power supply is reset.
Status byte register	3	QUES	If a quest enable condition changes, QUES is 1.
	4		
	5	ESB	If a standard event status enable register changes, ESB is 1.
	6	MSS	
	7	OPER	If a operation event enable register changes, OPER is 1.
operation status register	1	INST1	If the status of one operation status sub register changes, INST is 1
	2	INST2	As above
	3	INST3	As above

The Structure of the condition register is as followed:

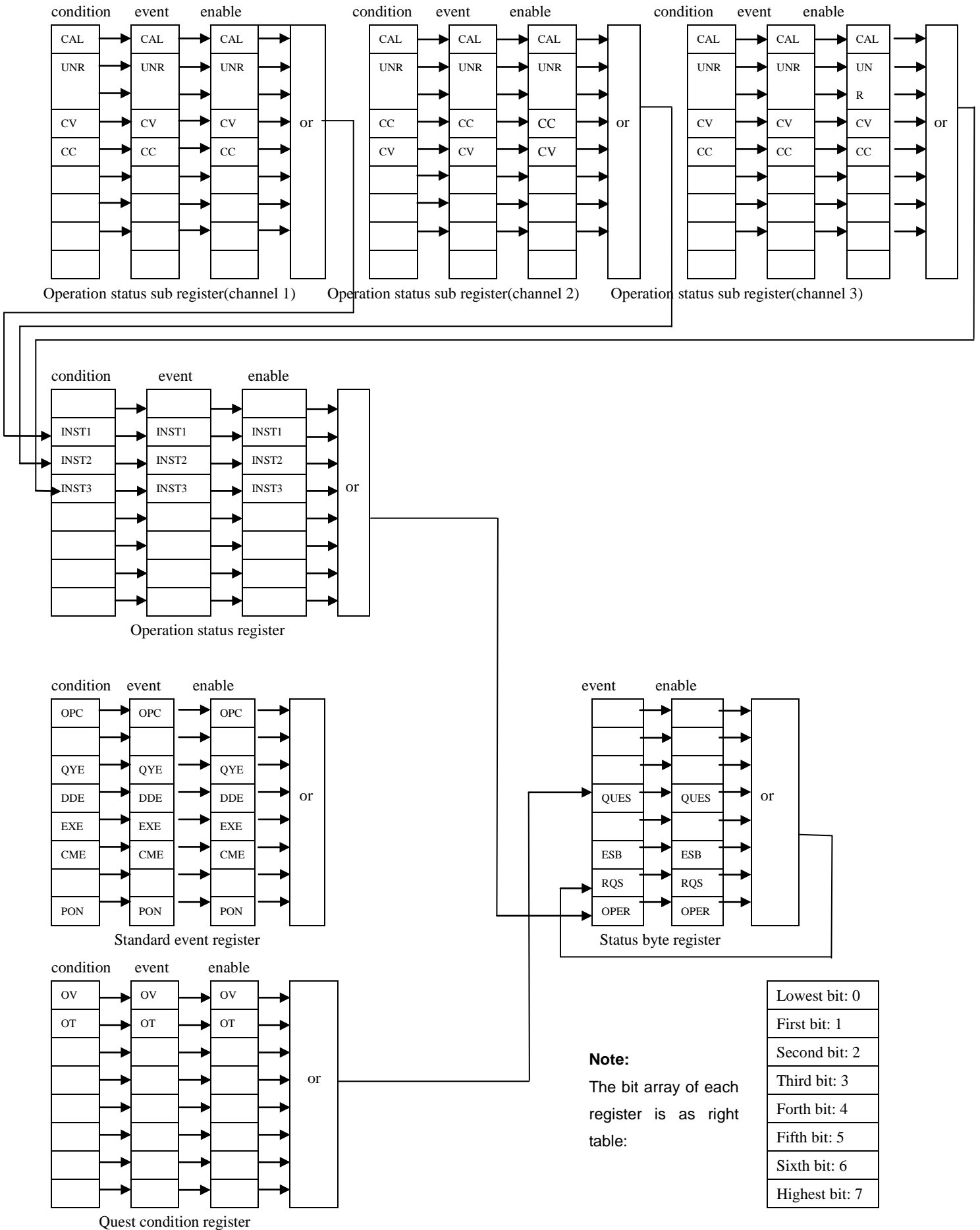

5.4.2 SCPI Command Description

Common IEEE488.2 Commands

***CLS**

This command clears the following registers:

- ◆ Standard event status register
- ◆ Quest condition register
- ◆ Operation status register
- ◆ Operation status sub register
- ◆ Status byte register
- ◆ Error code

Command syntax: ***CLS**

Parameter: None

***ESE**

This command sets the parameter of the standard event enable register. The value determines which bit value of the standard event register is set to 1. The ESB bit in of the status byte register will change to 1 to reflect the changes.

Command syntax: ***ESE <NRf>**

Parameter: 0~255

Reset value: Consult *PSC command

Example: *ESE 128

***ESR?**

This command queries the standard event status register. After executing this command, the standard event status register is reset. The bit definition of the standard event status register is identical to the standard event status enable register

Query syntax: ***ESR?**

Return parameter: <NR1>

Example: *ESR?

***IDN?**

This command reads information about the power supply. The return value contains 4 segments divided by a comma.

Query syntax: ***IDN?**

Return parameter: <AARD>

segment	description
BK Precision	manufacturer
XXXX	model
XXXXXX	product serial number

For example: BK PRECISION, 9130, 000000000000111101,V1.66

***OPC**

When all commands sent to the instrument prior to this command have been executed, OPC of the standard event status register will be set to 1.

Command syntax: ***OPC**

Query syntax: ***OPC ?**

Example: ***OPC**

***PSC**

This command controls if the power supply sends a query or not when it is reset.

1|ON: When power supply is reset, operation event enable register, quest event enable register and standard event status register are all reset.

0|OFF: The data of operation event enable register, Quest event enable register and standard event status enable register is stored in a nonvolatile register, and is recalled when power supply is reset.

Command syntax: ***PSC**

Parameter: 0|1|ON|OFF

Return parameter: data stored

Example: ***PSC ON**

***RST**

This command resets the power supply to its default setting.

Command syntax: ***RST**

Example: ***RST**

***SRE**

This command can set the parameter of the status byte enable register. The value of this parameter determines which bit value of the status byte register is 1 and the byte will enable RQS of status byte register is 1. The bit definition of the status byte enable register is the same as the status byte register.

Command syntax: ***SRE <parameter>**

Parameter: 0~255

Reset value: consult command ***PSC**

Example: ***SRE 110**

***STB?**

This command reads data from the status byte register. After executing this command, the status byte register is reset.

Command syntax: ***STB ?**

Return parameter: <NR1>

Example: ***STB?**

***SAV**

This command saves the operating parameters of the power supply to non-volatile memory. The

parameters include constant current, constant voltage, maximum voltage value and step voltage values.

Command syntax: *SAV

Parameter: 0~49

Example: *SAV 10

***RCL**

This command recalls parameter saved previously (using the *SAV command).

Command syntax: *RCL

Parameter: 0~49

Example: *RCL 10

Essential SCPI Commands

SYSTem:ERRor

This command is used to obtain error information from the power supply.

Command syntax: SYSTem:ERRor?

Return parameter: please consult the error information table

Example: SYST:ERR?

SYSTem:VERSion

This command queries the software version.

Command syntax: SYSTem:VERSion?

Return parameter: software version

Example: SYST:VERS?

SYSTem:BEEPer

This command controls the buzzer

Command syntax: SYSTem:BEEPer[:IMMEDIATE]

Example: SYST:BEEP

SYSTem:LOCal

This command can set the instrument to local (operate from front panel) mode

Command syntax: SYSTem:LOCal

Example: SYST:LOC

SYSTem:REMote

This command configures the power supply for remote control mode.

Command syntax: SYSTem:REMote

Example: SYST:REM

SYST:RWLock

This command also sets the instrument to remote control mode. When using this command, it is not possible to press LOCAL key on the front panel to revert back to manual mode.

Command syntax: SYSTem:RWLock

Example: SYST:RWL

SYSTem:ADDRess

This command reads the communication address of the power supply.

Command syntax: SYSTem:ADDRess?

Example: SYST:ADDR?

STATus:QUEStionable:ENABle

This command sets the parameter of the quest event enable register. This parameter determines which bit of the quest event register is set to 1. If a QUES condition changes, the QUES bit of status byte register will be set to 1.

Command syntax: STATus:QUEStionable:ENABle <parameter>

Parameter: 0~255

Reset value: Consult PSC command

Example: STAT:QUES:ENAB 110

STATus:QUEStionable:ENABle?

This query returns a value which corresponds to the binary weighted sum of all bits enabled by STAT:QUIES:ENAB command. After this command executed, quest event enable register is reset.

Command syntax: STATus:QUEStionable:ENABle ?

Return parameter: <NR1>

Example : STAT:QUES:ENAB?

STATus:QUEStionable?

This command reads parameters from the quest event register. After this command executed, quest event register is reset.

Command syntax: STATus:QUEStionable[:EVENT]?

Return parameter: <NR1>

Example: STAT:QUES?

STATus:QUEStionable:CONDition?

This command queries the parameter of the quest condition register. When a bit value of the quest condition parameter changes, the corresponding bit value in the quest event register will be set to 1.

Command syntax:: STATus:QUEStionable:CONDition?

Return parameter: <NR1>

Example: STAT:QUES:COND?

STATus:OPERation ENABle

This command sets the parameter of the operation event enable register. The parameter determines which bit value of quest event register is set to 1. If a OPER condition changes, the OPER bit of the status byte register will be set to 1.

Command syntax: STATus: OPERation:ENABle

Parameter: 0~255
Reset value: consult PSC command
Example: STAT:OPER:ENAB 110

STATus:OPERation:ENABle?

This command queries parameters from the operation enable register

Command syntax: STATus:OPERation:ENABle?
Return parameter: <parameter of operation enable register>
Example: STAT:OPER:ENAB?

STATus:OPERation?

This command queries the operation condition register. After this command executed, the operation condition is reset.

Command syntax: STATus:OPERation[:EVENTt]?
Return parameter: <parameter of operation event register>
Example: STAT:OPER?

STATus:OPERation:INSTrument?

This command queries the operation event sub register. After this command executed, the operation event sub register is reset.

Note: this command is only valid for current channel.

Command syntax: STATus:OPERation:INSTrument[:EVENTt]?
Return parameter: <parameter of operation event sub register>
Example: STAT:OPER:INST?

STATus:OPERation:INSTrument:ENABle

This command sets the parameter of operation event enable sub register. Setting parameter can determine which bit value of operation event enable sub register is 1 and the bit will enable OPER of status byte register is 1.

Note: this command is only valid for current channel.

Command syntax: STATus:OPERation:INSTrument:ENABle <value>
Parameter: 0~255
Reset value: consult PSC command
Example: STAT:OPER:INST:ENAB 110

STATus:OPERation:INSTrument:ENABle?

This command queries the parameter of the operation event enable sub register. After this command executed, operation event enable sub register is reset.

Note: this command is only valid for the currently active channel.

Command syntax: STATus:OPERation:INSTrument:ENABle ?
Return value: <parameter of operation event enable register>
Example: STAT:OPER:INST:ENAB?

STATus:OPERation:INSTrument:CONDition?

This command queries parameters from operation condition sub register. After this command is executed, the operation condition sub register is reset.

Note: this command is only valid for current channel.

Command syntax: STATus:OPERation:INSTrument:CONDition?

Return parameter: <parameter of operation condition register>

Example: STAT:OPER:INST:COND?

INSTrument[SELEct]

This command can be used to select the channel.

Command syntax: INSTrument[:SELEct]

Parameter: FIRst|SECOnd|THIrd

Reset value: FIRst

Example: INST SECO

INSTrument[:SELEct]?

This command returns the number of the selected channel

Command syntax: INSTrument[:SELEct]?

Return parameter: FIRst|SECOnd|THIrd

Example: INST?

INSTrument:NSELEct

This command is similar to the command “INSTrument[SELEct]”, the only difference is that this command uses numbers to denote the channel.

Command syntax: INSTrument:NSELEct

Parameter: 1~3

Reset value: 1

Example: INST:NSEL ?

OUTPut[:STATe]

This command sets the output state for the current channel to ON or OFF

Command syntax: OUTPut[:STATe] <parameter>

Parameter: 1(ON)|0(OFF)

Example: OUTP 1

OUTPut[:STATe]?

This command queries the output state of the current channel is ON or OFF

Command syntax: OUTPut[:STATe]?

Return parameter: 0|1

Example: OUTP?

OUTPut:TIMer:DATA

This command sets the time of the output-timer for the current channel.

Command syntax: OUTPut:TIMer:DATA <parameter>

Parameter: 0~999999S (if you set 0S,the output-timer will be disabled.)

Reset value: It is concerned about the parameter you set in the menu.

Example: OUTPut:TIMer:DATA 100

OUTPut:TIMer:DATA?

This command queries the time of the output-timer for the current channel.

Command syntax: OUTPut:TIMer:DATA?

Return parameter: 0~999999

Unit: S

Example: OUTP:TIM:DATA?

[SOURce:]CURRent[:LEVel][:IMMediate][:AMPLitude]

This command sets the current value of the power supply.

Command syntax: [SOURce:]CURRent[:LEVel][:IMMediate][:AMPLitude] <parameter>

Parameter: MIN|MAX|MIN TO MAX

Unit: A mA uA

Reset value: It is concerned about the parameter you set in the menu.

*RST value: MAX

Example: CURR 2A

[SOURce:]CURRent[:LEVel][:IMMediate][:AMPLitude]?

This command checks the current value of the power supply.

Command syntax: [SOURce:]CURRent[:LEVel][:IMMediate][:AMPLitude]? <parameter>

Parameter: MIN | MAX |None

Return parameter: MIN TO MAX

Unit: A

Example: CURR?

[SOURce:]VOLTage[:LEVel][:IMMediate][:AMPLitude]

This command sets the voltage value of the power supply.

Command syntax: [SOURce:]VOLTage[:LEVel][:IMMediate][:AMPLitude]

Parameter: MIN|MAX|MIN TO MAX

Parameter: V mV uV kV

Reset value: IN TO MAX|MIN|MAX

*RST value: MIN

Example: VOLT 10V

[SOURce:]VOLTage[:LEVel][:IMMediate][:AMPLitude]?

This command reads the voltage value of the power supply.

Command syntax: [SOURce:]VOLTage[:LEVel][:IMMediate][:AMPLitude]? <parameter>

Parameter: MIN|MAX|None

Reset value: MIN TO MAX

Unit: V

Example: VOLT?

[SOURCE:]VOLTage:PROTection[:LEVel][:IMMediate][:AMPLitude]

This command sets the max. voltage for the current channel.

Command syntax: [SOURCE:]VOLTage:PROTection[:LEVel][:IMMediate][:AMPLitude] <parameter>

Parameter: IN TO MAX|MIN|MAX

Unit: V mV kV uV

Reset value: It is concerned about the parameter you set in the menu.

*RST value: MAX

Example: VOLT:PROT 20V

MEASure[:SCALer]:CURRent[:DC]?

This command reads the actual output current of the power supply.

Command syntax: MEASure[:SCALer]:CURRent[:DC]?

Return parameter: The actual output current

Unit: A

Example: MEAS:CURR?

MEAS[:SCALer][:VOLTage][:DC]?

This command reads the actual output voltage value.

Command syntax: MEAS[:SCALer][:VOLTage][:DC]?

Return parameter: The actual output voltage

Unit: V

Example: MEAS?

MEASure[:SCALer]:POWer[:DC]?

This command reads the actual output power value.

Command syntax: MEASure[:SCALer]:POWer[:DC]?

Return parameter: The actual output power

Unit: W

Example: MEAS:POW?

DISPlay[:WINDow][:STATe]

This command turns the VFD display on/off.

Command syntax: DISPlay[:WINDow][:STATe] <parameter>

Parameter: 0(OFF)|1(ON)

Reset value: 1(ON)

*RST value: 1(ON)

Example: DISP 1

DISPlay[:WINDow][:STATe]?

This command checks the state of the display.

Return parameter: 1(ON)|0(OFF)

Example: DISP?

6. PV9130 Software Guide

6.1 Introduction

PV9130 is a software application for the 9130 Triple Output Programmable DC Power Supply. To use this software communication you need either communication adapter cable IT-E131 or IT-E132. This application software supports all the functionality available through the front panel. Additionally you can generate and execute simple test sequences.

6.2 Installation

1. Requirements for computer

Pentium processor-based personal computer
Windows 98/2000/NT/XP/VISTA

2. Installation

Insert the included CD into the CD drive, locate PV9130 and install the software according to the onscreen instructions.

6.3 PV9130 basics

After launching software PV9130, you should see following screen:

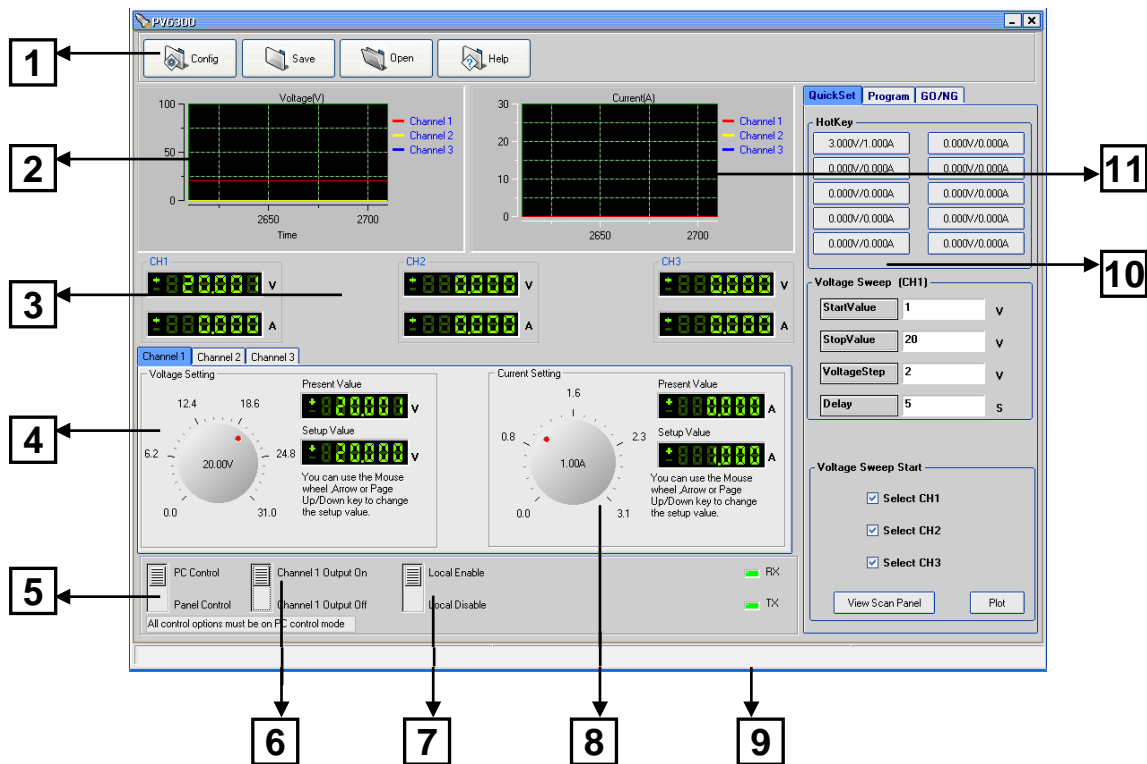

- 1** Configure the software operating parameters and serial communication parameters.
- 2** Voltage chart
- 3** Voltage and current displayed for all 3 channels
- 4** Set the voltage value
- 5** Set operation mode: PC Control or Panel Control
- 6** Set the output state: Output On/Output Off
- 7** “Local Enable” allows the user to use the front panel keys while the instrument is in remote control mode. When “Local Disable” is active, the front panel keys of the instrument are disabled.
- 8** Set the current value
- 9** Status bar: Displays the power supply model, communication status and operation status.
- 10** Set voltage and current value quickly and conveniently via predefined hotkeys
- 11** Current chart

6.3.1 Save and Open



Save the program, Quick Set, voltage sweep and GO/NG settings to a PAR file.



Open the program, Quick Set, voltage sweep and GO/NG settings stored in a PAR file.

6.3.2 Chart Description

The voltage and current chart can help you to analyze voltage and current changes more easily.

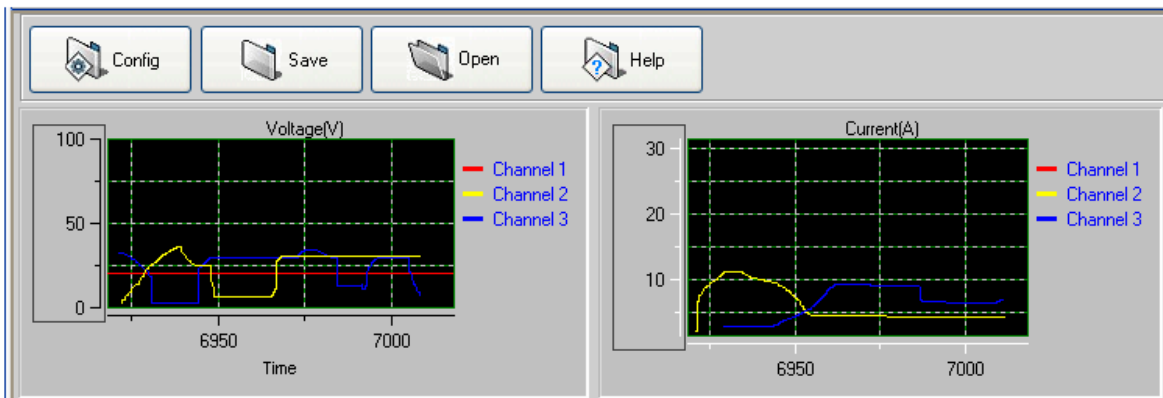

If you want to observe the voltage and current change curve after you have set the voltage and current value for

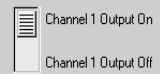
one channel, please make sure that the channel's output state is on . If you want to observe the voltage and current curve at the same time, you need to set voltage and current value for each channel one by one, and turn the channel's output state on.

Note: After you have set voltage/current values or the output state for one channel and you want to set parameters for another channel, you can select the channel you want to configure directly via the tabs  (blue means the channel is selected). The other channel's state isn't affected.

6.3.3 Status bar

The status bar will give you the communication information. When communication is successful, the status bar will display the following:

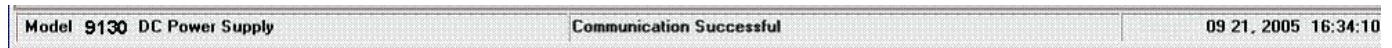

Power mode

Communication status

Time

- 1) **Power mode:** it will display the real part number of the field power supply which detected by the computer. (9130)
- 2) **Communication status:** If **Communication waiting** appears in the status bar for more than 10 seconds, you need to check your configuration and connection between computer and power supply. If necessary, reconfigure the baud rate, address, COM port etc to make sure the parameters on both sides match.

6.4 Operation

6.4.1 Configure the system

The first step is to configure the system and set up communication. Click the  button and the following windows will be displayed:

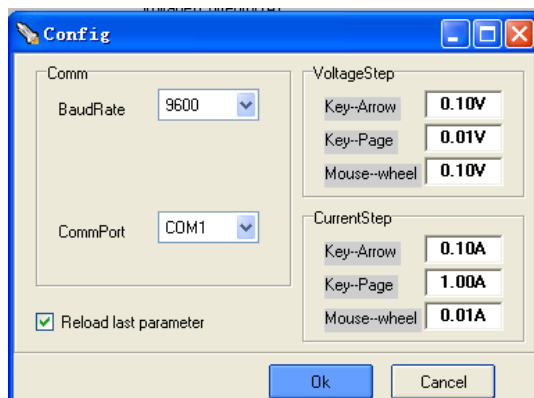

- 1) **Comm:** Set the communication port and baud rate
- 2) **Voltage/Current Step** Set the step size of the arrow key, page up/down key, and mouse-wheel. When you set the value via knob (coarse adjustment), you can use the arrow keys ($\uparrow, \downarrow, \leftarrow, \rightarrow$), page up/down keys or mouse wheel for fine adjustment.
- 3) **Reload last parameter:** When you check this box, the last parameters from a previous session (before closing this application) will be loaded.

Note: When you set the communication port, please make sure that the baud rate of the computer matches that of the power supply. Also make sure that “Parity” in the power supply menu is set to “None” (default value).

6.4.2 Setting Voltage and Current

Before setting voltage/current values, you need to select a channel. If you want to set voltage and current for several channels, you can do so by setting one channel at a time

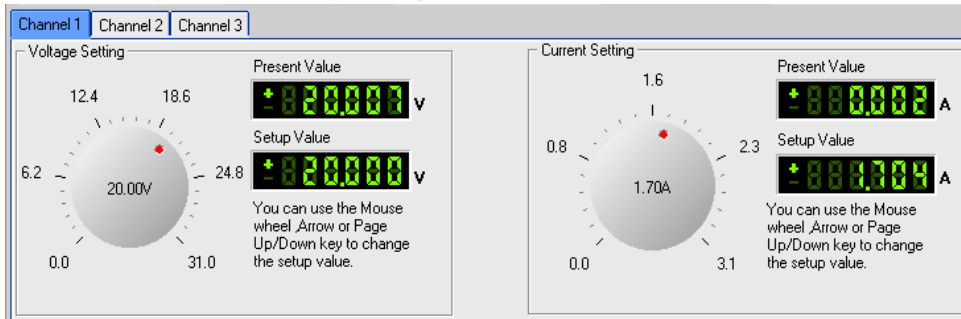

Use the mouse to click on the rotary knob and move the mouse to change the value. You also can use the mouse wheel, or Page Up/Down keys and arrow keys (↑, ↓, ←, →) from the keyboard for fine adjustment of voltage or current values.. The setup value will be displayed on the second line indicator.

6.5 Test sequence generation

6.5.1 Quickset

Hot Keys

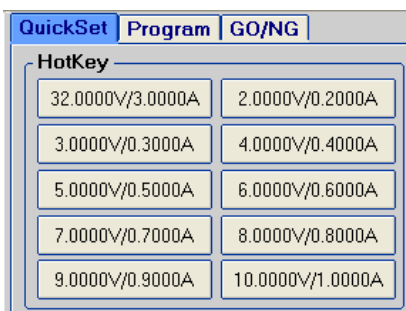

Hotkey : Right-click each Hotkey Button, it will display

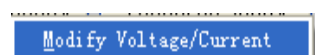

, Click on it, it will display as follows, change the voltage/current value as you desired, then click “OK” button to confirm.

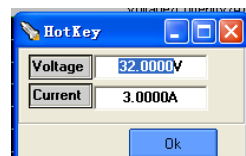

Note: The voltage/current value you set should not exceed the max voltage /current value.

Voltage Sweep

Before this operation, please select the channel you need: .

Enter parameters StartValue, StopValue, voltageStep and Delay. Press “View Scan Panel”, then “Run” to sweep from the Start to the Stop value once or “Step” to manually execute each test step.

Refer to the on line help for more details

6.5.2 Program

Write a simple sequence of test steps using this tool.

Before programming, please select the channel: .

Right-click in the Program area. The program tools (AppendLine, Insert Line, DeleteLine) will appear. Use these tools to define each test step and add new test steps.

Click on “View Test Control Panel” to execute your test sequence. Select “Run” to execute the sequence in a loop, “Once” or Custom (define the number of loops)

For more details, refer to the on-line help.

6.5.2 Go/NG

This tool allows you to write a simple test sequence including min/max values. The test program generates a pass fail verdict and an optional test report.

Before test, please select the channel: .

Right-click in the Program area. The program tools (AppendLine, Insert Line, DeleteLine) will appear. Use these tools to define each test step and add new test steps.

Click on “View Test Control Panel” to execute your test sequence. Select “Run” to execute the sequence in a loop, “Once” or Custom (define the number of loops)

For more details, refer to the on-line help.

[left intentionally blank]

Service Information

Warranty Service: Please return the product in the original packaging with proof of purchase to the address below. Clearly state in writing the performance problem and return any leads, probes, connectors and accessories that you are using with the device.

Non-Warranty Service: Return the product in the original packaging to the address below. Clearly state in writing the performance problem and return any leads, probes, connectors and accessories that you are using with the device. Customers not on open account must include payment in the form of a money order or credit card. For the most current repair charges please visit www.bkprecision.com and click on “service/repair”.

Return all merchandise to B&K Precision Corp. with pre-paid shipping. The flat-rate repair charge for Non-Warranty Service does not include return shipping. Return shipping to locations in North America is included for Warranty Service. For overnight shipments and non-North American shipping fees please contact B&K Precision Corp.

B&K Precision Corp.
22820 Savi Ranch Parkway
Yorba Linda, CA 92887
www.bkprecision.com
714-921-9095

Include with the returned instrument your complete return shipping address, contact name, phone number and description of problem.

Limited Three-Year Warranty

B&K Precision Corp. warrants to the original purchaser that its products and the component parts thereof, will be free from defects in workmanship and materials for a period of **three years** from date of purchase.

B&K Precision Corp. will, without charge, repair or replace, at its option, defective product or component parts. Returned product must be accompanied by proof of the purchase date in the form of a sales receipt.

To obtain warranty coverage in the U.S.A., this product must be registered by completing a warranty registration form on www.bkprecision.com within fifteen (15) days of purchase.

Exclusions: This warranty does not apply in the event of misuse or abuse of the product or as a result of unauthorized alterations or repairs. The warranty is void if the serial number is altered, defaced or removed.

B&K Precision Corp. shall not be liable for any consequential damages, including without limitation damages resulting from loss of use. Some states do not allow limitations of incidental or consequential damages. So the above limitation or exclusion may not apply to you.

This warranty gives you specific rights and you may have other rights, which vary from state-to-state.

B&K Precision Corp.
22820 Savi Ranch Parkway
Yorba Linda, CA 92887
www.bkprecision.com
714-921-9095



22820 Savi Ranch Parkway
Yorba Linda, CA 92887
www.bkprecision.com

© 2009 B&K Precision Corp.