

Since 1968

COMMAX
SmartHome & Security

User Manual

WI-249LM / WI-249LS



※ WI-249LM



※ WI-249LS

www.commax.com

COMMAX Co.,Ltd.



- Thank you for purchasing COMMAX products.
- Please carefully read this User's Guide (in particular, precautions for safety) before using a product and follow instructions to use a product exactly.
- The company is not responsible for any safety accidents caused by abnormal operation of the product.



1. Table of Contents

1. Table of Contents	1
2. Safety Warning & Caution	2
3. Parts and Description	4
4. Product Concept	6
5. Main Device (WI-249LM)	6
6. Sub Device (WI-249LS)	9
7. Specification and Features	12

2. Safety Warning & Caution

Please follow the things described below in order to prevent any danger or property damage.

	Warning	It may cause a serious damage or injury if violated.		Prohibition.
	Caution	It may cause a minor damage or injury if violated.		No disassembly
				No touch
				Must follow strictly.
				Shows plugging out the power cord without an exception
				Shows the warning and caution for an electric shock.
				Shows the warning and caution for a fire.

Warning

Power & Installation

Please don't use several products at the same time on one power socket.

- It may cause a fire due to an abnormal overheating.

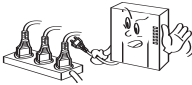

Please don't bend the power cable excessively or it may cause an electric shock.

- fire when using a damaged power cable.

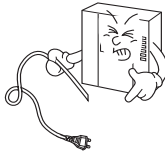

Please don't handle the power cable with a wet hand.

- It may cause an electric shock.

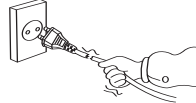

Please plug out the power cable from the socket when not using it for a long period of time.

- It may shorten the product lifespan or cause a fire.

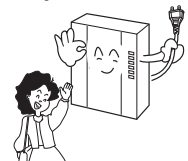

Please don't install the product in the place where there is much oil, smoke or humidity.

- It may cause an electric shock or fire.

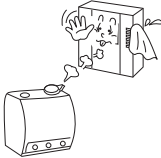

Please don't install the product with the lightning and thunder.

- It may cause an electric shock or fire.

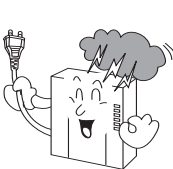

Please don't use and connect this product with other products with different rated voltage.

- It may cause a disorder or fire.

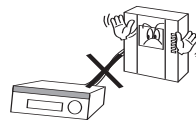

When installing the product that generates heat, please install the product away from the wall (10cm) for the ventilation.

- It may cause a fire due to the increased internal temperature.

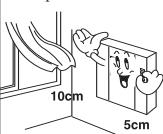

⚠ Warning

Cleaning & Use

Please don't disassemble, repair or rebuild this product arbitrarily (please contact the service center if a repair is needed).

- It may cause an electric shock or fire.



If an abnormal sound, burning smell or smoke is coming out of the product, please plug out the power cable and contact a service center.

- It may cause an electric shock or fire.

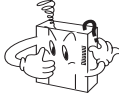

Please don't insert any metallic or burnable materials into the ventilation hole.

- It may cause an electric shock or fire.



Please use only the designated batteries for the products of using DC power.

- It may cause an electric shock or fire.



⚠ Caution

Power & Installation

Please plug the power cable firmly into the inner end

- It may cause a fire.

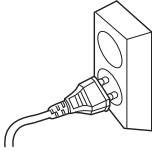

Please hold the plug tightly when unplugging the power cable (a part of the copper wire may be disconnected if the grabbing is only made on the cord when pulling out the cable).

- It may cause an electric shock or fire



When connecting the power cables after cutting the cable, please install the product with power off

- It may cause an electric shock or fire



When installing the product, please fix it firmly while using the wall-mounting unit and screws.

- It may cause an injury from the falling object.

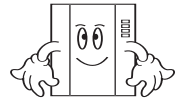

Please be careful when using an AC circuit breaker since there is a possibility of an electric shock.

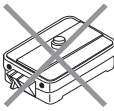

Please check the use voltage and current for the DC-only products and use the appropriate rectifier.

- It may cause a fire.



Please avoid direct rays of the sun or heating devices at a time of installation.

- It may cause a fire.



Please don't install the product on an unstable place or small support board.

- It may cause an injury if it falls down while in use.

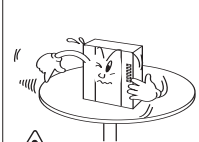

Cleaning & Use

When cleaning the product, please rub it with a soft and dry cloth after plugging out the power cable. (Please don't use any chemical products such as wax, benzene, alcohol or cleanser.)



Please don't drop the product on the ground and don't apply a shock.

- It may cause a failure.

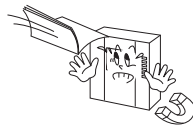

Please use the designated connection cable within the maximum calling distance designated for the product

- It may reduce the product performance.





3. Parts and Description

► Main Device : WI-249LM

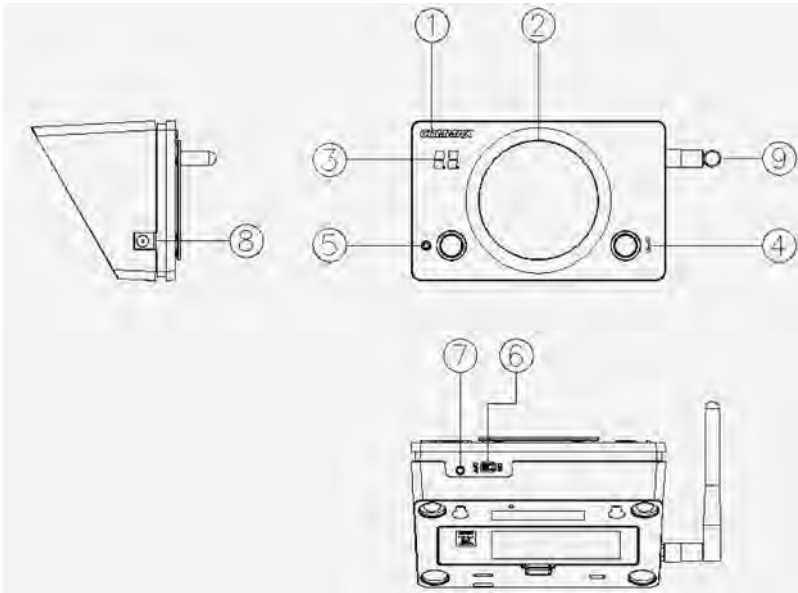

No.	Parts Name	No.	Parts Name
1	Microphone	6	Power switch
2	Speaker	7	Volume switch
3	FND display	8	DC adaptor input
4	Paging button	9	Antenna
5	Select button		

► Sub Device : WI-249LS

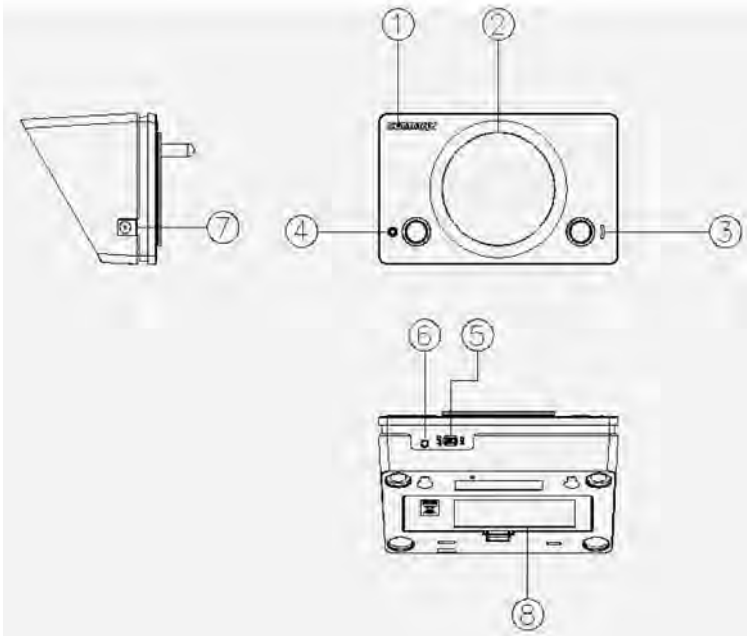

No.	Parts Name	No.	Parts Name
1	Microphone	5	Power switch
2	Speaker	6	Volume switch
3	Paging button	7	DC Adaptor Input
4	Select button & Battery	8	Battery



4. Product Concept

WI-249LM/S Devices are two-way wireless intercom system communicating via 2.4GHz frequency.

- **System Diagram**

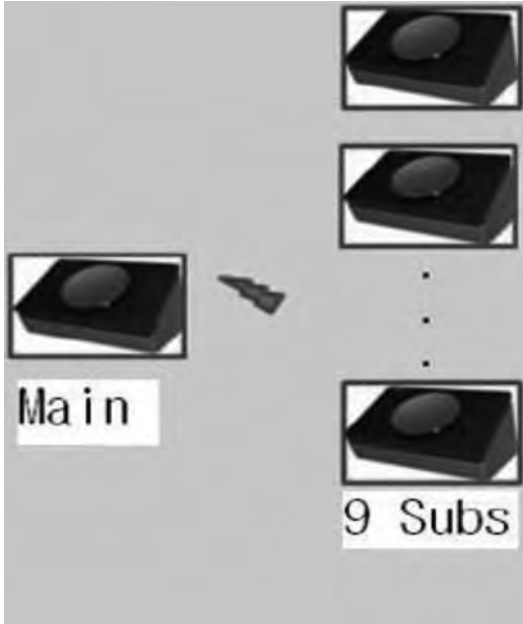

5. Main Device (WI-249LM)

- **Turning the power on**

Connect 5.0V / 1A power adaptor to ⑧ DC adaptor input located on the side of WI-249LM.

Turn the ⑥ Power switch on located at the bottom of WI-249LM. At the right-lower side of FND Display, a small dot LED is on to indicate the device is on.

- **Pairing (Main / Sub devices)**

The main device allocates a number to each sub device from number '00' to '99' when pairing. For example, if you would like to allocate the number '03' to a WI-249LS, use the ⑤ Select button to choose '03' and press ⑦ Volume switch for 5 seconds to pair each other.

When in pairing mode, two dot LEDs are blinking. When pairing is completed, '03' disappears and a double beep will sound. You can repeat the same method to pair all other sub devices with the main device. Only the numbers between 00 and 99 are valid for allocation.

- **Paging Volume Adjustment**

In standby mode, simply press the ⑦ Volume switch to adjust the paging volume. There are 3 levels (low-normal-high) of volume adjustments available and default is set as 'normal'.

Every time the volume switch is pressed, the volume level changes from normal → high → low → normal → high in this order. If no input for 3 seconds, the device stores the last input value and goes in to standby mode.

- **Call Volume Adjustment**

While in talking mode, press the ⑦ Volume switch to adjust the call volume. There are 3 levels (low-normal-high) of volume adjustments available and default is set as 'normal'. Every time the volume switch is pressed, the volume level changes from normal → high → low → normal → high in order. If no input for 3 seconds, the device stores the last input value and goes in to standby mode.

- **When Sub device (WI-249LS) Pages Main device (WI-249LM)**

When a sub device (WI-249LS) pages the main device (WI-249LM), the seven-segment display on the main device (WI-249LM) displays the ID number of the sub device (the number allocated to the sub device from the pairing process). When paged, the display blinks repeatedly every 0.25 seconds.

- **When Main device (WI-249LM) Pages Sub device (WI-249LS)**

Use the ⑤ Select button to choose a sub device you wish to page and press the ④ Paging button. While paging, the display blinks repeatedly every 0.25 seconds. If the ④ Paging button is pressed without any sub device being selected, the sub device with the allocated number '00' will be paged (***** the main device WI-249LM can page any sub-devices only when the sub devices are connected to DC power adaptor, not running on batteries.**)

- **To Hang Up the Call**

Simply press the paging button once again to hang up the call. While in talking mode, the display blinks repeatedly every 0.05 seconds.

- **Time Limit for Paging Mode**

Paging time is limited to 30 seconds. After 30 seconds, paging stops and the device goes in to standby mode.

- **Time Limit for Talking Mode**

Talking mode is limited to 3 minutes. After 3 minutes, the call is ended and the device goes in to standby mode.

- **Pagine Tone**

The paging tone is as follows :

Sol-Mi-Do Sol-Mi-Dol → 2 second pausel → Sol-Mi-Do Sol-Mi-Dol → 2 second pausel → Sol-Mi-Do Sol-Mi-Dol → Repeat until answered and/or stops paging after 30 seconds.

- **Low Voltage Indication of Sub devices on the Main device display**

If the sub devices (WI-249LS) are running on batteries and the batteries are low, the sub device will send the low voltage information to the main device as paging the main device.

The FND display on the main device, after disconnecting with the sub device, displays the ID

number of the sub device in a blinking mode.

After replacing the batteries, you need to page the main device to register the new battery level value and the main device must answer the call to register the new value.

- **Replacing a Sub device (WI-249LS)**

If any of the paired sub devices is replaced, please try to use the same ID number of the removed device to minimize the ID allocating processes.

- **Inverting the FND Display on Main device (WI-249LM)**

Press ④ Paging button and ⑤ Select button simultaneously for 5 seconds to invert the displayed number. This is useful when the main device is to be mounted on a wall or above the eye level shelf.

- **Factory Default Setting (Initializing)**

To initiate a factory default setting, first turn off the device using the ⑥ Power switch located at the bottom of the device. Turn the power switch back on while pressing ④ Paging button and ⑤ Select button simultaneously. The display blinks repeatedly every 0.1 second to indicate the device is in factory default setting mode. Press the ⑦ Volume switch to initiate the factory default setting. All data including volume levels and pairing information is now deleted and set with factory default setting.

- **Mute Mode**

In standby mode, press ⑤ Select button for 5 seconds to deactivate the built-in microphone. The device is now in mute mode. Repeat the same method to activate the microphone

- **SINGLE SPEED DIAL FUNCTION ON MAIN DEVICE (WI-249LM)**

Without selecting any sub devices and directly pressing the paging button will page the sub device with "00" ID number. If none of sub devices is being allocated with number "00", the main device does not page any devices.



6. Sub Device (WI-249LS)

- **Turning the power on**

There are two modes available to power on the sub devices.

- **AA Battery Mode**

4 x AA size batteries are to be placed in WI-249LS and turn on the ⑤ Power switch.

- **5.0V / 1A Power Adaptor**

When a DC power adaptor (5.0V / 1A) connected, the sub device recognizes it and automatically goes in to a “constant power mode”, enabling the 2-way paging mode between main and sub devices. Turn the power on by sliding the ⑤ Power switch located at the bottom of the device.

- **Pairing (Main / Sub Devices)**

A number between 00 and 99 must be allocated to each sub device WI-249LS. Turn the ⑤ Power switch on and press ③ Paging button and ⑥ Volume button for 5 seconds to activate the pairing mode. The Red LED is blinking repeatedly every 0.5 seconds to indicate that the devices are in pairing mode. A double beep sounds to indicate the pairing is completed. The pairing mode is limited to 60 seconds.

- **Paging Volume & Call Volume Adjustment**

Paging and Call volume of sub devices are adjusted simultaneously. The volume is to be adjusted while in talking mode with the main device by pressing the ⑥ Volume button located at the bottom of the device. There are 3 levels (low-normal-high) of volume adjustments available and default is set as 'normal'. Every time the volume switch is pressed, the volume level changes from normal → high → low → normal → high in this order. If no input for 3 seconds, the device stores the last input value and goes back in to talking mode.

- **Time Limit for Paging Mode**

Paging time is limited to 30 seconds. After 30 seconds, paging stops and the device goes in to standby mode.

- **Time Limit for Talking Mode**

Talking mode is limited to 3 minutes. After 3 minutes, the call is ended and the device goes in to standby mode.

- **Paging Tone (WI-249LS)**

The paging tone is as follows :

Sol-Mi-Do Sol-Mi-Do → 2 second pause → Sol-Mi-Do Sol-Mi-Do → 2 second pause → Sol-Mi-Do Sol-Mi-Do → Repeat until answered and/or stops paging after 30 seconds.

- **Line Busy Notice**

If a sub device pages the main device while the main device is already in connection with another sub device, a line busy tone sounds and the sub device goes back in to standby mode.

- **Factory Default Setting (Initializing)**

To initiate a factory default setting, first turn off the device using the ⑤ Power switch located at the bottom of the device. Turn the power switch back on while pressing ③ Paging button and ④ Select button simultaneously. The display blinks repeatedly every 0.1 second to indicate the device is in

factory default setting mode. Press the ⑥ Volume switch to initiate the factory default setting. All data including volume levels and pairing ID number is now deleted and set with factory default setting.

- **Red LED Indication When Paging**

When paging, the Red LED blinks repeatedly every 0.25 seconds.

- **Red LED Indication When Talking**

When in talking mode, the Red LED blinks repeatedly every 0.05 seconds.

- **WI-249LS with Constant Power Supply (5.0V / 1A Power Adaptor)**

When a DC power adaptor (5.0V / 1A) connected, the sub device recognizes it and automatically goes in to a "constant power mode", enabling the 2-way paging mode between main and sub devices. If battery powered, the main device WI-249LM is not being able to page any sub devices (Sub devices can page the main device), 1-way paging mode only.

- **Auto Call Accepting Mode**

When sub devices are on a constant power mode (connected with 5V/1A power adaptor), press 4Select button for 5 seconds to activate the auto call accepting mode. If the main device pages the sub device, the call is connected automatically without a paging sound and the time limit for talking mode is now unlimited.

- **Factory Default Setting**

To initiate a factory default setting, first turn off the device using the ⑤ Power switch located at the bottom of the device. Turn the power switch back on while pressing Paging button and Select button simultaneously. The display blinks repeatedly every 0.1 second to indicate the device is in factory default setting mode. Press the Volume switch to initiate the factory default setting. All data including volume levels and pairing ID number is now deleted and set with factory default setting.

- **Forced Voice Forwarding Function (PTT Mode)**

WI-249LM/S devices are half duplex type which automatically determines the direction of audio communication for effective sound quality by eliminating hauling and echo effects. If one side creates a constant loud noise or talks loud constantly, the microphone on the other side is deactivated at all times providing one sided communication. In this case, initiate a talk while pressing the "Select button". By releasing the Select button, the device is back to normal talking mode.

- **Repeater**

This is an optional mode for a sub device, WI-249LS.

After registering main and sub devices to a repeater, the communication is now enabled only through the repeater. It means if the repeater is turned off, the registered devices cannot communicate each other.

- **Repeater Setting**

Connect 5V / 1A DC power adaptor to WI-249LS. By pressing the ④ Select button and ③ Paging

button simultaneously for 5 seconds, you can turn the sub device into a repeater mode. The Red LED blinks every 1 second to indicate a repeater mode. To turn the power off, use the ⑤ Power switch at the bottom of the device. Repeater mode is enabled only if a constant power is supplied by a power adaptor (5V / 1A DC power adaptor).

- **Pairing (Main WI-249LM/Repeater)**

Press the ⑥ Volume switch on a repeater for 5 seconds to go in to pairing mode. The Red LED blinks every 0.5 seconds to indicate that the repeater is in pairing mode. A sound of a double beep indicates the pairing is completed. The pairing mode lasts for 60 seconds.

- **Pairing (Repeater/Sub WI-249LS)**

Press the 3Paging switch on a repeater for 5 seconds to go in to pairing mode. The Red LED blinks every 0.5 seconds to indicate that the repeater is in pairing mode. A sound of a double beep indicates the pairing is completed. The pairing mode lasts for 60 seconds.

Repeat the same method if more than one sub devices are to be paired with the repeater.

- **Red LED Indication When Setting Up a Repeater.**

Red LED blinks every 1 second if the sub device is in Repeater mode.

- **Red LED Indication When Main Pages Sub Device**

Red LED blinks every 0.05 seconds if the Main device pages sub devices including ones not paired with a repeater.

- **Red LED Indication When Sub Pages Main Device**

Red LED blinks every 0.05 seconds if the Sub device pages main device.

- **Factory Default Setting**

To initiate a factory default setting, first turn off the device using the 5Power switch located at the bottom of the device. Turn the power switch back on while pressing Paging button and Select button simultaneously. The display blinks repeatedly every 0.1 second to indicate the device is in factory default setting mode. Press the Volume switch to initiate the factory default setting. All data is deleted and set with factory default setting.



7. Specification and Features

Model	WI-249LM	WI-249LS
Call Method	GFSK	
Power Source	5V \equiv , 1A	5V \equiv , 1A or or AA Alkaline Battery 4EA
Standby Consumption	0.8W	0.8W(Adaptor)
Power Communication	1.4W	1.2W
Communication Method	HANDS FREE (half duplex)	
Display	FND	LED
Ring tone	Chime	
Distance	Open area : 200M,	Indoor : 40~50M
Temperature	0 ~+40°C (32°F ~ 104°F)	
Dimensions	140(W) X 72(H) X 88(D)	

- It is likely to be affected by surroundings. Call quality may be poor, if it is affected by Elevators, high voltage, Radio Frequency Interference and iron doors.

COMMAX

COMMAX Co.,Ltd.

513-11, Sangdaewon-dong, Jungwon-gu, Seongnam-si, Gyeonggi-do, Korea

Int'l Business Dept. Tel. : +82-31-7393-540~550 Fax. : +82-31-745-2133

Web site : www.commax.com

PM18249LMS10

Printed In Korea / 2014.04.104