

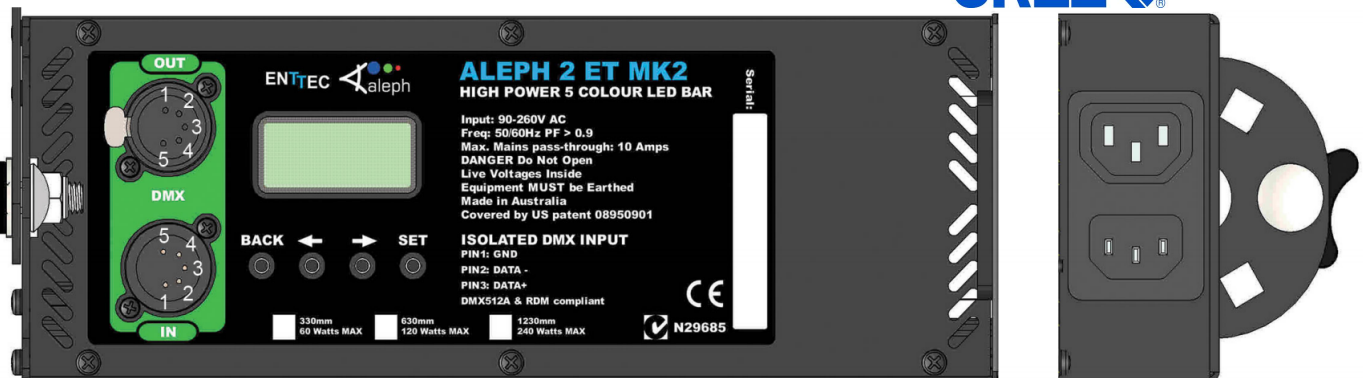

ALEPH2 ET Mk2

5 COLOUR HIGH POWER LED LIGHT BAR
300mm/600mm/1200mm



Back Panel



 Please make sure the Power pass-through current does not exceed 10 Amps

Features

- Strong aluminium chassis with small profile
- DMX512 Controllable and RDM Configurable
- Can use up to 12 DMX channels, depending on configuration
- Snapshots: 64 fully user recordable slots, 50 different pre-loaded stand-alone colours
- 16-bit or Smart 8-bit LED dimming
- Strobe Mode with controllable frequency from DMX
- Fan-less smart heat management
- Easy addressing and configuration interface
- 180° Adjustable mounting bracket
- Changeable diffuser using holder accessory (sold separately)

Cleaning

It is important to clean the ALEPH2 ET Mk2 to maintain a long service life. Make sure the unit is unplugged before you attempt any cleaning.

- Surface dust should be removed with an air compressor, please make sure you do not blow compressed air directly inside the unit.
- Optics can be cleaned with a glass cleaner or IPA with a soft cloth
- Make sure the unit is dry and there is no cleaning fluid residue before powering the unit after cleaning.





Safety

- Do not expose the ALEPH2 ET Mk2 to rain or moisture, doing this will void your warranty.
- Do not spill water or other liquids into or onto your unit.
- Do not look directly into the LEDs, doing so may damage your eyes.
- Check that the local power outlet matches the required voltage (120 → 240V AC)
- Make all the connections before you plug in the main power.
- Do not remove the cover under any condition. There are no user serviceable parts inside.
- Never operate this unit when its cover is removed.
- Never plug this unit in to a dimmer rack.
- Always be sure to mount this unit in an area that will allow proper ventilation. Allow at least 20 cm between this device and a wall.
- Make sure ventilation holes are clean and unobstructed.
- Do not attempt to operate this unit, if it becomes damaged.
- Always mount this unit in a safe and stable manner.
- Power-supply cords should be routed carefully.
- The unit should be situated away from heat sources

Control Panel

After powering up, the current firmware version is displayed, followed by the DMX Start Address.

The unit can be configured by using the 4 buttons under the display as follows.

 BACK	<ul style="list-style-type: none"> -If pressed while address is being displayed: It activates the back-light and goes to Main Menu -If pressed while setting a menu: It takes you to the previous level without changing anything
 ←	<ul style="list-style-type: none"> -Scrolls down when navigating the menu -Decreases the value displayed when setting a parameter -Hold the key for a few seconds to fast scroll down
 →	<ul style="list-style-type: none"> -Scrolls up when navigating the menu -Increases the value displayed when setting a parameter -Hold the key for a few seconds to fast scroll up
 SET	<ul style="list-style-type: none"> -Confirms the displayed value -Activates the displayed function or -Opens the next menu

The following is the menu setting structure:

Main Menu	Level 1	Level 2	
Setup	DMX Address	Value: 001 to 512	
	Personality	1 – 8bit RGBAW Mode	
		2 – 8bit RGBW Mode	
		3 – 8bit 6ch Mode	
		4 – 16bit 12ch Mode	
		5 – Extended 9ch Mode	
		6 – 8bit 1ch Mode	
	Pre-sets	Value: 01 to 64	
	Lamp On Mode	OFF	
		DMX	
PWM Frequency	ON		
	Value: 500 to 2000		
Back-lite	NORMAL		
	ON		
Factory Defaults	OFF		
	YES		
Temperature	NO		
	LED TEMP		
Test	CPU TEMP		
	LED 1		
	LED 2		
	LED 3		
	LED 4		
	LED 5		
	LED 6		
	ALL LEDs		
Firmware Version 2.xy			

DMX Address Menu

The DMX start address is the most important parameter to be defined when setting up your lights. By default the fitting will be set to 001.

The addressing will depend on the current selected personality. For example if the light is set to RGBAW mode (5 channels), the DMX address range will be 001 – 508.

Personality Menu

The ALEPH2 ET Mk2 has six different personalities or operational modes, which can either be selected remotely from any standard RDM controller tool or locally using the control panel. The light behaves differently in each mode, since the DMX channel distribution changes according to the desired working personality. Set the desired personality before patching your lights in any lighting desk or control system.

1 – 8BIT RGBAW MODE (5 Channel)

This basic mode will turn the ET into a 5 channel light, allowing to drive each available colour as an independent dimmer. Each DMX channel uses 8 bits resolution where 000 is OFF, 255 is Full intensity, as described in the following chart.

1 st Channel	2 nd Channel	3 rd Channel	4 th Channel	5 th Channel
RED GROUP	GREEN GROUP	BLUE GROUP	AMBER GROUP	WHITE GROUPS

2 – 8BIT RGBW MODE (4 Channel)

As some lighting control systems do not support RGBAW lights, we have implemented a RGBW mode so the fitting can be used with any controller. Each DMX channel uses 8 bits resolution where 000 is OFF, 255 is Full intensity, as described in the following chart.

1 st Channel	2 nd Channel	3 rd Channel	4 th Channel
RED GROUP	GREEN GROUP	BLUE GROUP	WHITE GROUPS

3 – 8BIT (6CHANNEL) MODE

This basic mode will allow you to drive each colour using 8 bits resolution, setting the values from one of the 6 DMX channels where 000 is OFF, 255 is Full intensity, as described in the following chart.

1 st Channel	2 nd Channel	3 rd Channel	4 th Channel	5 th Channel	6 th Channel
RED GROUP	GREEN GROUP	BLUE GROUP	AMBER GROUP	WHITES GROUP1	WHITES GROUP2

Example 1: to turn all the channels to full intensity, set all the channels to 255 value:

1 st Channel	2 nd Channel	3 rd Channel	4 th Channel	5 th Channel	6 th Channel
255	255	255	255	255	255

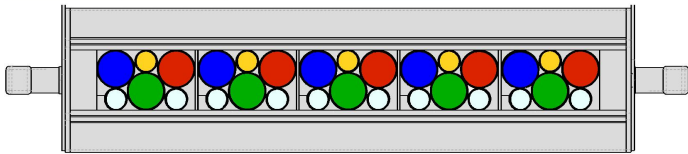

Example 2: to turn only the red group colour to full intensity, set the first channel to 255 value:

1 st Channel	2 nd Channel	3 rd Channel	4 th Channel	5 th Channel	6 th Channel
255	000	000	000	000	000

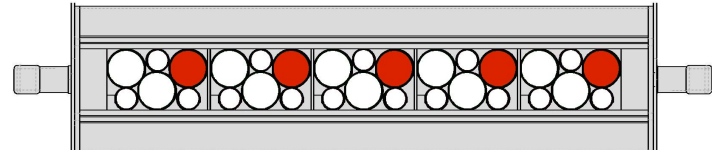

The smart dimming in this personality follows an “s” curve resulting in a smooth LED output all along the 8 bits range.

4 - 16BIT (12 CHANNEL) MODE

This mode will allow you to drive each colour using 16 bits resolution; setting the values from one of the 12 DMX channels from 000 to 255 where the first channel of each group will be (HIGH) and the following channel the (LOW) one, as described in the following chart.

1 st Channel	2 nd Channel	3 rd Channel	4 th Channel	5 th Channel	6 th Channel
RED GROUP (HIGH)	RED GROUP (LOW)	GREEN GROUP (HIGH)	GREEN GROUP (LOW)	BLUE GROUP (HIGH)	BLUE GROUP (LOW)
7 th Channel	8 th Channel	9 th Channel	10 th Channel	11 th Channel	12 th Channel
AMBER (HIGH)	AMBER (LOW)	WHITES (HIGH)	WHITES (LOW)	WHITES (HIGH)	WHITES (LOW)

This personality gives the user full control on the output dimming, so any colour combination can be generated.

5 - EXTENDED (9 CHANNEL) MODE

This extended mode offers a wide variety of output effects, turning the ALEPH2 ET Mk2 into a very versatile unit, using 9 DMX channels, as described in the following chart.

1 st Channel	2 nd Channel	3 rd Channel	4 th Channel	5 th Channel
RED GROUP	GREEN GROUP	BLUE GROUP	AMBER GROUP	WHITE GROUPS
6 th Channel	7 th Channel	8 th Channel	9 th Channel	
STROBE DURATION	STROBE FREQUENCY	MASTER DIMMER	TRUE CCT MODE	

COLOUR GROUP INTENSITY (CH1-CH5) operate as described in the RGBAW personality plus they can be modified or affected by the strobe function or master dimmer channel, as described further in this section.

Although these 6 channels have no effect when the true CCT mode is activated (9th channel > 010)

STROBE DURATION (CH6) this channel works in conjunction with the strobe frequency from CH7. It will only take any effect if the channel 7th > 10.

It defines the duration of the ON state and linearly increases the time from 2.5 milliseconds when 000 to 650 milliseconds when 255.

NOTE: Strobe duration time must be lower than Strobe frequency for flashing. If duration time is equal or greater than frequency, the light will be continuously ON.

STROBE FREQUENCY (CH7) will turn the ALEPH2 ET Mk2 bar into a versatile multi-colour strobe with user adjustable frequency. The strobe feature can be activated by setting the channel to a value between 011 and 255. In the same range, the strobe frequency can be adjusted by varying the channel value, with 011 the lowest frequency (about 0.3 flashes per second) and 255 the highest one (25 flashes per second).

The strobe channel can be used in conjunction with all the other channels, so you can change the current output colour or the master intensity whilst strobing at the selected frequency, all at the same time.

DMX Value	Color Temperature	Reference Colour
255	12000 K	
237	11000 K	
205	10000 K	
182	9000 K	Bluish White
166	8000 K	
144	7000 K	
118	6000 K	Cool White
093	5000 K	
070	4000 K	Neutral White
046	3000 K	
035	2500 K	
022	2000 K	Warm White
011	1800 K	

MASTER DIMMER (CH8) drives the general intensity, multiplying with all other current output channels, with 000 the lowest intensity 0% (light will be OFF, regardless of other channel values) and 255 the highest, allowing 100% whatever other channels are demanding.

TRUE CCT MODE (CH9) will turn the ALEPH2 ET Mk2 bar into a true colour temperature adjustable fitting, simulating a tungsten light behaviour.

The white colour feature can be activated by setting the channel to a value greater than 010. CH9=011 will produce the warmest white and 255 the coolest one. Values between 000-010 will stop the true CCT feature.

The true CCT mode channel can be used in conjunction with strobe and master dimmer features, so you can strobe and/or dim the current white output set by this channel.

The ALEPH2 ET Mk2 has been laboratory calibrated to closely follow the black body Locus curve. With 8 bits resolution allowing the light to travel from TRUE warm to cool whites (12000K to 1800K) keeping a high CRI for natural colours.

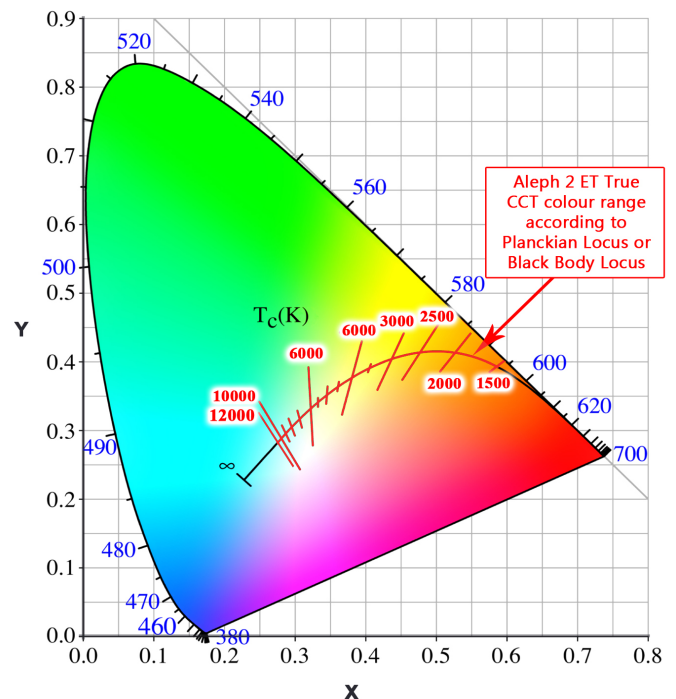

6 – 8BIT 1CHANNEL MODE

This mode turns the Aleph 2 ET Mk2 into a single colour, single channel dimmer.

The output colour is not any specific kind of white and this mode is not tuned up to produce balanced output. It is only

meant to produce as much light as possible using only one control channel.

This mode is often used to control custom built A2 lights where only white LEDs are populated instead of coloured LEDs.

Presets Menu

The Aleph2 ET Mk2 has 64 available slots where the user can record custom colours from DMX. These can later be activated from the menu. Presets turn the ET into a stand-alone fitting, where 64 different colours can easily be triggered on-site, without the need of DMX.

It is also possible to record user personalised presets on any of the 64 memory slots, overwriting the default ones.

RECORDING CUSTOM PRESETS:

To record your own colours, please scroll to the desired slot (from 01 to 64), feed the desired data through the DMX port until you are happy with the look. Then press the SET key to overwrite the preset.

Pre-Set	Factory Default Colour	Pre-Set	Factory Default Colour
01	All channels OFF (Default on Start-Up)	26	Cool Grey
02	Red	27	Ciel
03	Green	28	Sky Blue
04	Blue	29	Turquoise
05	Amber	30	Aquamarine
06	Cool White	31	Clover
07	RGB Yellow	32	Mint
08	RGB Purple	33	Dark Pastel Green
09	RGB Cyan	34	Pistachio
10	2000K White	35	Lawn Green
11	2500K White	36	Lime
12	2700K White	37	Pear
13	3000K White	38	Apple Green
14	4000K White	39	Lemon
15	5000K White	40	Corn
16	6000K White	41	Golden Yellow
17	6500K White	42	Pumpkin
18	Bubble Gum	43	Carrot Orange
19	Carmine	44	Khaki
20	Pink	45	Ochre
21	Pink1	46	Salmon
22	Pastel Violet	47	Coral
23	Dark Violet	48	Coquelicot
24	Lavender	49	High luminance Cool White
25	Lavender Blue	50	High luminance Natural White

Slots 51 to 64 are available for user custom colours

IMPORTANT NOTES:

When the light is powered on, it will automatically take preset 01 as the default power on value, if the Lamp On Mode setting is ON. This feature is handy for the user to set up the desired colour combination for the fitting to start every time it is powered up.

Note that the strobe feature is not a supported preset.

Any incoming DMX data will override the presets, so ensure that there is no DMX data coming in before navigating this menu intending to playback the different colours.

Running the Factory Defaults RDM command will restore all the presets to the original values and user recorded presets will not be recoverable.

Lamp On Mode Menu

This setting instructs the ET about what to do after a power up sequence.

If DMX or OFF settings are chosen, the ET will stay off and will wait for DMX instructions.

When Lamp On Mode = ON the ET will power up and then output whatever drop has been recorded in slot 01 of the presets. Please notice that any incoming DMX will override this preset, as DMX takes the highest precedence.

PWM Frequency Menu

The PWM driving frequency can be adjusted. This might have an impact on the way some cameras respond to the light emitted by the A2 ET Mk2.

Backlight Menu

The NORMAL setting will turn the display green back light on after any key operation. It will turn it off after a 15 seconds of in-activity. The ON setting will keep the back light always on. The OFF setting will keep the back light always off, regardless of any operation.

Factory Defaults Menu

Running the Factory default sequence will reset all the user configurable parameters, including DMX address, presets, Personality, Lamp On mode, Etc.

Temperature Menu

This menu shows the current fixture temperature in degrees Celsius.

LED and CPU operating temperatures can be monitored from the control panel as well as RDM.

Test Menu

Using this menu you can test every group of LEDs in the ET fitting. The LEDs will turn on at full power, so avoid looking at the light directly when performing the test.

Firmware Version

Indicates the current firmware version installed in the fitting. Please check ENTTEC website for latest firmware version.

Firmware Update

Updating the firmware of the ALEPH2 ET Mk2 requires an ENTTEC USB Pro or a Pro Mk2 usb interface plugged in to a PC USB port. Connect the USB PRO to the ET through a standard 5 pin DMX cable.

Please download and install the RDM Controller App from www.enttec.com website, connect the widget to the unit, power it up and run the application.

To make sure the process has been successful, please the firmware version has changed by looking at the "Software Version ID" RDM field or navigate to the Firmware Version menu using the control panel.

RDM Capabilities

The ALEPH2 ET Mk2 supports RDM features and any RDM Controller can be used to configure it using RDM. The "ENTTEC RDM Controller" free App can be downloaded from ENTTEC website and be used in combination with a DMX USB PRO or a PRO MK2 widget.

The supported RDM parameters are:

Read only fields

- Device Info
- Software Version ID
- Supported Parameters
- Parameters Description
- DMX Personality Description
- Sensor Value (temperature x 2)

- Sensor Definition
- Boot Software Version
- Manufacturing Label
- Device Label
- Status Messages

User configurable fields

- Identify Device
- DMX Start Address
- PID_8001: Master faders
- DMX Personality
- Factory Defaults
- Lamp On Mode
- Reset Device
- Capture Preset
- Preset Playback

Please note that DMX Personality, DMX Start Address, Factory Defaults, Lamp On Mode and Presets fields can also be configured from the menu interface at the back of the light.

Specifications

Due to continuous improvements and innovations of all ENTTEC products, specifications and features are subject to change without notice.

Item	300mm	600mm	1200mm
Input Voltage	110 – 240V AC		
Input Frequency	50/60Hz		
Maximum Power Consumption	60 Watts	120 Watts	240 Watts
Light Output (all leds)	2500 lumen	5000 lumen	10000 lumen
Lumen/Watt	41.6		
CREE XP-E Led Quantity	30	60	120
Colours	Red, Green, Blue, Amber, Cool White x 2		
Diffuser	Clear Acrylic included, Additional diffusers sold separately		
Beam Angle	25°		
Control Input	DMX512 & RDM E1.20		
Smart Dimming	16 bit dimming mapped to 8 bit S curve		
Weight (Kg)	3.7	4.9	11
Weight (Pounds)	8.2	10.8	24
Cooling Method	Convection		
Ambient Temperature	5° to 50° C		
Surface Operating Temperature	75°C at steady state (full intensity output and Ta=45°C)		
Smart Thermal Management	Output smoothly dims down when over heated		
Protection Rating	IP20		
Connectors	1x 5-Pin Male XLR for DMX input 1x 5-Pin Female XLR for DMX output 1x IEC C13/C14 IN/OUT Socket for mains		

Colour Gamut

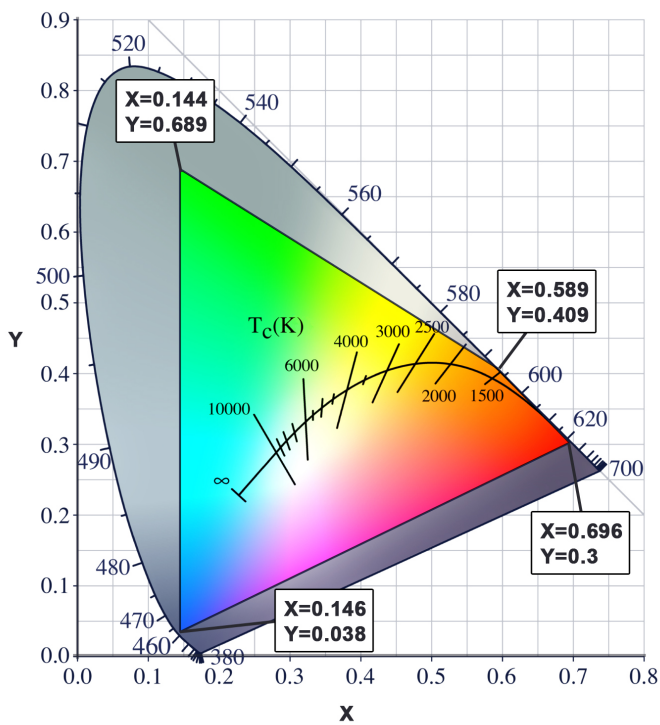

Dimensions

Item	A	B	C	D
ETMK2 300	340mm	400mm	100mm	3
ETMK2 600	640mm	700mm	200mm	3
ETMK2 1200	1240mm	1300mm	250mm	5

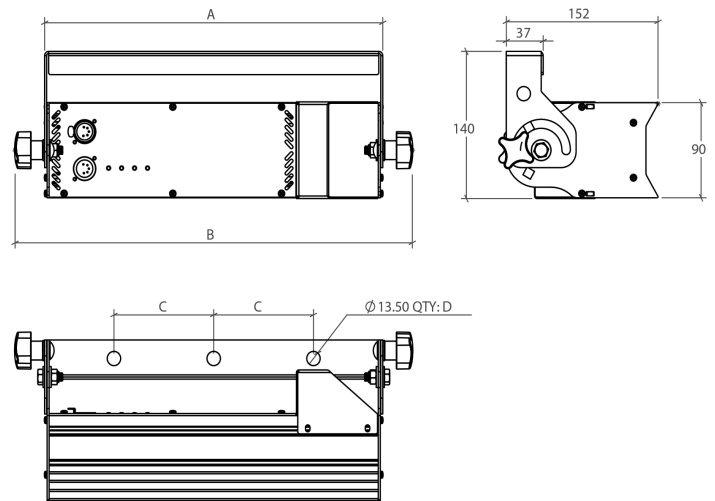

Ordering Information

Item	Part Number
A2 ET MK2 LED LIGHT BAR 300mm	73803-300
A2 ET MK2 LED LIGHT BAR 600mm	73803-600
A2 ET MK2 LED LIGHT BAR 1200mm	73803-1200
A2 ET 300m Diffuser Holder	79369
A2 ET 600m Diffuser Holder	79370
A2 ET 1200m Diffuser Holder	73972

Sales enquiries: sales@enttec.com

Support enquiries: support@enttec.com