

USER'S MANUAL

METER HOOD 60

Thank you for purchasing PIVOT METER HOOD 60 "Processing Kit" MH6-C. Please read these instructions carefully before installing or using this device. Please do not lose this user's guide, as you will held liable for the cost of reissuing it.

Check the contents

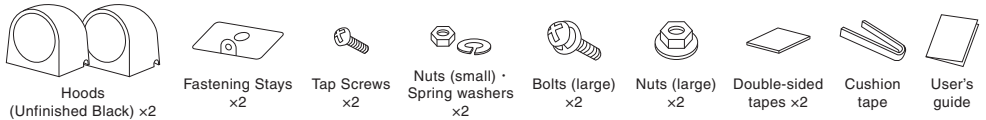

This Processing Kit allows you, the user, to cut, process and paint the hood to match the installation surface for the perfect fit and style.

※ If you are unsure about anything, please consult a professional at your local dealer or consider buying our "Multi-Purpose Type".

Preparation for process

Things to prepare



Convenient tool

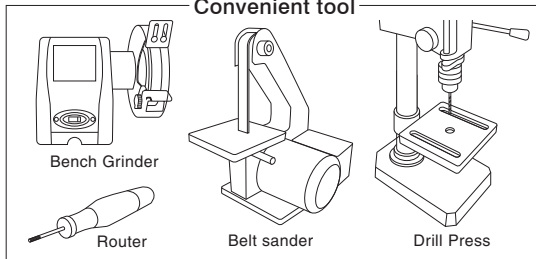

Actual size of mounting side of hood

Please use this for making sure the installation position will work properly.

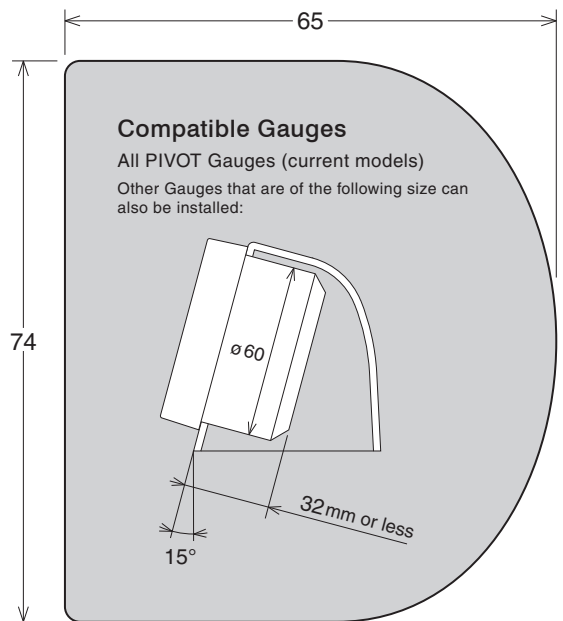

How to Process: An Example

1 Decide the Place of Installation

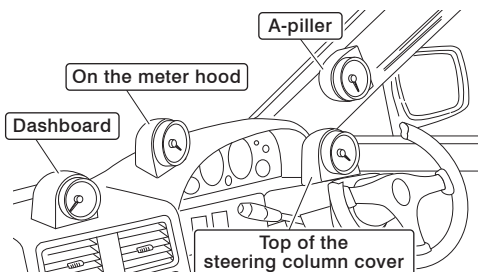

⚠ When deciding a place for installation make sure to select a place that does not interfere with airbags, standard measurement gauges, nor gets in the line of vision.

- ① Make a trial installation.
- ② Try to choose a flat surface.

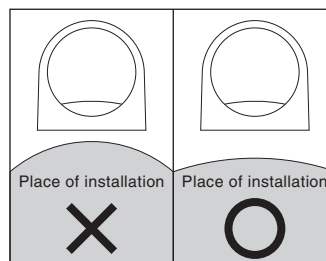

- ③ To install to the A-pillar it is necessary to drill a hole in the A-pillar.

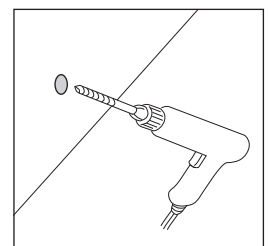

2 Process the Hood

Make necessary cuts to bottom of stand for a perfect fit to mounting surface and paint as desired.

- ① Take the gauge out from the hood, and slowly cut away spots that hinder a good fit.

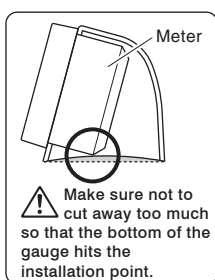
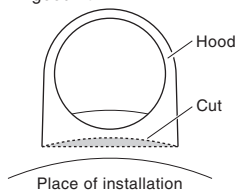

- ② Spot the stays on the hood and mark the position of the holes with a marker.

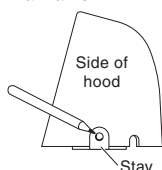

- ③ Open a 3mm hole with its center about 2mm above the marked circle made in step ②. (Please take into account the thickness of the stays and the double-sided tape.)

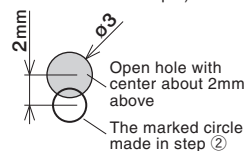

- ④ Paint the hood surface.



3 Fastening the Hood

Installing with the Double-sided tapes (dashboard, etc.)

- ① With screws fasten the stays to the holes made in the hood in ② above.

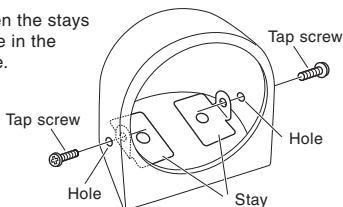

- ② With a mild detergent or alcohol remove all dirt and oil from the point of installation, lay the wires down in the wire channels and fasten down with the double-sided tape.

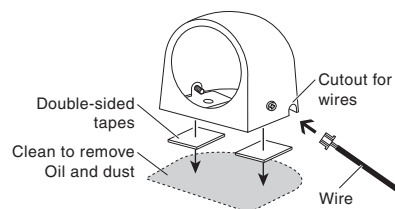

Installing to the A-pillar

※For details about how to remove the A-pillar, see the maintenance guide for your model of car.

- ① Temporarily fasten the stays to the hood and for now fasten to the location with double-sided tape.

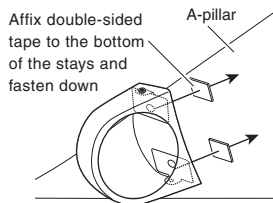
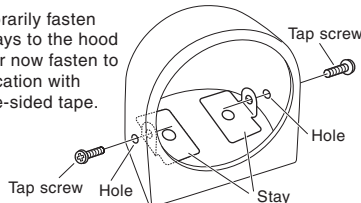

- ② With a marking pen make a mark for a wiring hole.

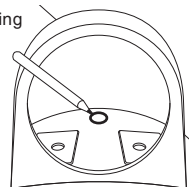

- ③ Remove the hood and tap screws.

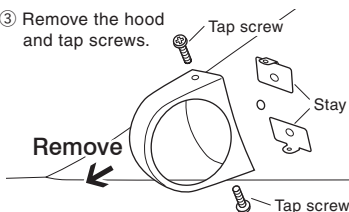

- ④ With the stays still fastened remove the A-pillar.

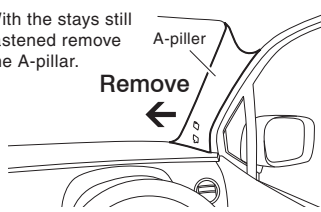

- ⑤ Open holes for the stays and for the wiring (wire size) that were made in ②.

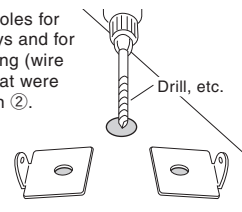

- ⑥ Using the holes made in ⑤ fasten hood to the stays with the screws.

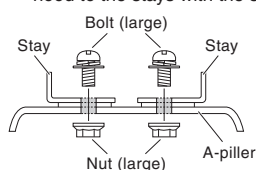

- ⑦ Screw the hood back onto the stays.

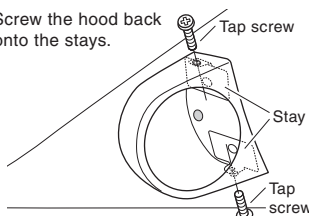

- ⑧ As you are leading the wires replace the A-pillar.

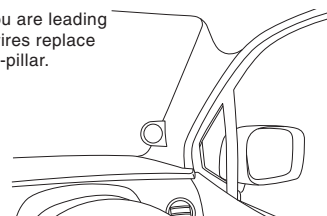

4 Fasten the meter to the meter hood

Fasten the supplied cushion tape to the meter case and fix the meter hood.

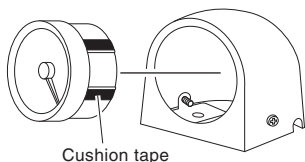

⚠ The tap screws will make ridges as they are being screwed in, but if closed too tightly they may not hold; if this happens please use the nuts and washers provided in the kit to securely fasten.

