

EN

User Manual

USER MANUAL

Oven

ZOE35511X

ZANUSSI

Contents

Safety information.....	2	Using the accessories.....	8
Safety instructions.....	3	Additional functions.....	10
Product description.....	5	Hints and tips.....	10
Before first use.....	5	Care and cleaning.....	15
Daily use.....	6	Troubleshooting.....	17
Clock functions.....	8	Energy efficiency.....	18

Subject to change without notice.

Safety information

Before the installation and use of the appliance, carefully read the supplied instructions. The manufacturer is not responsible if an incorrect installation and use causes injuries and damages. Always keep the instructions with the appliance for future reference.

Children and vulnerable people safety

- This appliance can be used by children aged from 8 years and above and persons with reduced physical, sensory or mental capabilities or lack of experience and knowledge if they have been given supervision or instruction concerning use of the appliance in a safe way and understand the hazards involved.
- Do not let children play with the appliance.
- Keep all packaging away from children.
- Keep children and pets away from the appliance when it operates or when it cools down. Accessible parts are hot.
- If the appliance has a child safety device, we recommend you activate it.
- Cleaning and user maintenance shall not be made by children without supervision.
- Children of less than 3 years should be kept away unless continuously supervised.

General Safety

- Only a qualified person must install this appliance and replace the cable.

- Internally the appliance becomes hot when in operation. Do not touch the heating elements that are in the appliance. Always use oven gloves to remove or put in accessories or ovenware.
- Before maintenance cut the power supply.
- Ensure that the appliance is switched off before replacing the lamp to avoid the possibility of electric shock.
- Do not use a steam cleaner to clean the appliance.
- Do not use harsh abrasive cleaners or sharp metal scrapers to clean the glass door since they can scratch the surface, which may result in shattering of the glass.
- If the supply cord is damaged, it must be replaced by the manufacturer, its Authorised Service Centre or similarly qualified persons in order to avoid a hazard.
- To remove the shelf supports first pull the front of the shelf support and then the rear end away from the side walls. Install the shelf supports in the opposite sequence.
- The means for disconnection must be incorporated in the fixed wiring in accordance with the wiring rules.

Safety instructions

Installation



WARNING!

Only a qualified person must install this appliance.

- Remove all the packaging.
- Do not install or use a damaged appliance.
- Obey the installation instruction supplied with the appliance.
- Always be careful when you move the appliance because it is heavy. Always wear safety gloves.
- Do not pull the appliance by the handle.
- The kitchen cabinet and the recess must have suitable dimensions.
- Keep the minimum distance from the other appliances and units.
- Make sure that the appliance is installed below and adjacent safe structures.
- Parts of the appliance carry current. Close the appliance with furniture to prevent touching the dangerous parts.
- The sides of the appliance must stay adjacent to appliances or to units with the same height.

Electrical connection



WARNING!

Risk of fire and electrical shock.

- All electrical connections should be made by a qualified electrician.
- The appliance must be earthed.
- Make sure that the electrical information on the rating plate agrees with the power supply. If not, contact an electrician.
- Always use a correctly installed shockproof socket.
- Do not use multi-plug adapters and extension cables.
- Make sure not to cause damage to the mains plug and to the mains cable. Should the mains cable need to be replaced, this must be carried out by our Authorised Service Centre.
- Do not let mains cables touch or come near the appliance door, especially when the door is hot.
- The shock protection of live and insulated parts must be fastened in such a way that it cannot be removed without tools.

- Connect the mains plug to the mains socket only at the end of the installation. Make sure that there is access to the mains plug after the installation.
- If the mains socket is loose, do not connect the mains plug.
- Do not pull the mains cable to disconnect the appliance. Always pull the mains plug.
- Use only correct isolation devices: line protecting cut-outs, fuses (screw type fuses removed from the holder), earth leakage trips and contactors.
- The electrical installation must have an isolation device which lets you disconnect the appliance from the mains at all poles. The isolation device must have a contact opening width of minimum 3 mm.
- This appliance complies with the E.E.C. Directives.

Use



WARNING!

Risk of injury, burns and electrical shock or explosion.

- Use this appliance in a household only.
- Do not change the specification of this appliance.
- Make sure that the ventilation openings are not blocked.
- Do not let the appliance stay unattended during operation.
- Deactivate the appliance after each use.
- Be careful when you open the appliance door while the appliance is in operation. Hot air can release.
- Do not operate the appliance with wet hands or when it has contact with water.
- Do not apply pressure on the open door.
- Do not use the appliance as a work surface or as a storage surface.
- Open the appliance door carefully. The use of ingredients with alcohol can cause a mixture of alcohol and air.
- Do not let sparks or open flames to come in contact with the appliance when you open the door.
- Do not put flammable products or items that are wet with flammable products in, near or on the appliance.



WARNING!

Risk of damage to the appliance.

- To prevent damage or discoloration to the enamel:

- do not put ovenware or other objects in the appliance directly on the bottom.
- do not put aluminium foil directly on the bottom of the appliance.
- do not put water directly into the hot appliance.
- do not keep moist dishes and food in the appliance after you finish the cooking.
- be careful when you remove or install the accessories.
- Discoloration of the enamel has no effect on the performance of the appliance. It is not a defect in the sense of the warranty law.
- Use a deep pan for moist cakes. Fruit juices cause stains that can be permanent.
- This appliance is for cooking purposes only. It must not be used for other purposes, for example room heating.
- Always cook with the oven door closed.

Care and cleaning



WARNING!

Risk of injury, fire, or damage to the appliance.

- Before maintenance, deactivate the appliance and disconnect the mains plug from the mains socket.
- Make sure the appliance is cold. There is the risk that the glass panels can break.
- Replace immediately the door glass panels when they are damaged. Contact the Authorised Service Centre.
- Be careful when you remove the door from the appliance. The door is heavy!
- Clean regularly the appliance to prevent the deterioration of the surface material.
- Remaining fat or food in the appliance can cause fire.
- Clean the appliance with a moist soft cloth. Only use neutral detergents. Do not use abrasive products, abrasive cleaning pads, solvents or metal objects.
- If you use an oven spray, obey the safety instructions on the packaging.
- Do not clean the catalytic enamel (if applicable) with any kind of detergent.

Internal light

- The type of light bulb or halogen lamp used for this appliance is only for household appliances. Do not use it for house lighting.



WARNING!

Risk of electrical shock.

- Before replacing the lamp, disconnect the appliance from the power supply.
- Only use lamps with the same specifications.

Disposal



WARNING!

Risk of injury or suffocation.

- Disconnect the appliance from the mains supply.

Product description

General overview

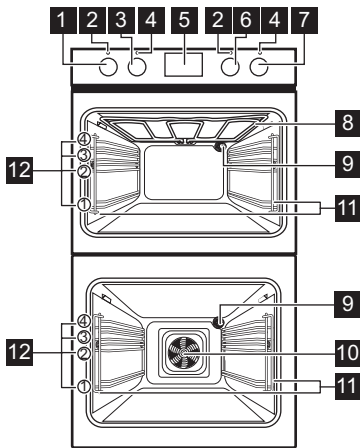

- Cut off the mains cable and discard it.
- Remove the door catch to prevent children and pets to get closed in the appliance.

Service

- To repair the appliance contact an Authorised Service Centre.
- Use original spare parts only.

- 1 Knob for the top oven functions
- 2 Power lamp / symbol / indicator
- 3 Knob for the top oven temperature
- 4 Temperature lamp / symbol / indicator
- 5 Electronic programmer
- 6 Knob for the main oven functions
- 7 Knob for the main oven temperature
- 8 Heating element
- 9 Lamp
- 10 Fan
- 11 Shelf support, removable
- 12 Shelf positions

Accessories

- **Wire shelf**
For cookware, cake tins, roasts.
- **Grill- / Roasting pan**
To bake and roast or as pan to collect fat.

Trivet

For roasting and grilling.



Use the trivet only with the Grill- / roasting pan.

Before first use



WARNING!

Refer to Safety chapters.

Initial Cleaning

Remove all accessories and removable shelf supports from the appliance.



Refer to "Care and cleaning" chapter.

Clean the appliance before first use. Put the accessories and the removable shelf supports back to their initial position.

Setting the time

You must set the time before you operate the oven.



Only the top oven works without the set time.

The indicator for the Time of day function flashes when you connect the appliance to the electrical supply, when there was a power cut or when the timer is not set.

Press the **+** or **-** button to set the correct time.
After approximately five seconds, the flashing stops and the display shows the time of day you set.

Changing the time

i You cannot change the time of day if the Duration **|→|** or End **→|** function operates.

Press **⌚** again and again until the indicator for the Time of Day function flashes.
To set a new time, refer to "Setting the time".

Preheating

Preheat the empty appliance to burn off the remaining grease.

Daily use

! **WARNING!**
Refer to Safety chapters.

Activating and deactivating the top / main oven



i **It depends on the model if your appliance has knob symbols, indicators or lamps:**

- The indicator comes on when the oven heats up.
- The lamp comes on when the oven operates.
- The symbol shows whether the knob controls one of the cooking zones, the oven functions or the temperature.

Top oven functions





Oven function	Application
 Light	To activate the lamp without a cooking function.

i Preheat the two ovens. Heat up one oven at a time.
Set the functions listed below, if applicable.



1. Set the function  and the temperature to 250°C.
Let the appliance operate for 1 hour.
2. Set the function  and the temperature to 250°C.
Let the appliance operate for 15 minutes.
3. Set the function  and the temperature to 250°C.
Let the appliance operate for 15 minutes.

Accessories can become hotter than usual. The appliance can emit an odour and smoke. This is normal. Make sure that the airflow is sufficient.

1. Turn the knob for the top / main oven functions to select an oven function.
2. Turn the knob for the temperature to select a temperature.
3. To deactivate the oven turn the knob for the top / main oven functions to the off position.

Oven function		Application
	Conventional Cooking	To bake and roast food on 1 shelf position.
	Top Heat	To brown bread, cakes and pastries. To finish cooked dishes.
	Bottom Heat	To bake cakes with crispy bottom and to preserve food.
	Grilling	To grill flat food and to toast bread.
	Fast Grilling	To grill flat food in large quantities and to toast bread.

Main oven functions

Symbol	Oven function	Application
	Light	To activate the lamp without a cooking function.
	True Fan Cooking	To bake on 1 shelf position and to dry food. Set the temperature 20 - 40 °C lower than for Conventional Cooking.
	Defrost	To defrost frozen food.

Display

 The electronic programmer works only with the main oven.

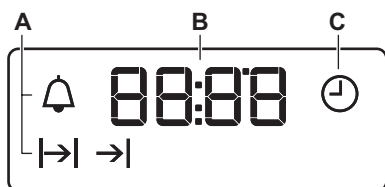

- A) Function indicators
- B) Time display
- C) Function indicator

Buttons

Button	Function	Description
—	MINUS	To set the time.

Button	Function	Description
	CLOCK	To set a clock function.
+	PLUS	To set the time.

Clock functions

Clock functions table

Clock function		Application
	Time of day	To set, change or check the time of day.
	Minute Minder	To set countdown time. This function has no effect on the operation of the appliance.
	Duration	To set the cooking time of the oven.
	End	To set the time of day when the oven should deactivate.

i You can use the functions Duration and End at the same time to set the time for how long the appliance should operate and when the appliance should deactivate. This lets you activate the appliance with a delay in time. First set the Duration and then the End .

Setting the clock functions

For Duration and End , set an oven function and temperature of cooking. This is not necessary for the Minute Minder .

1. Press again and again until the indicator for the necessary clock function starts to flash.
2. Press or to set the time for the necessary clock function.

The clock function operates. The display shows the indicator for the clock function you set.

Using the accessories



WARNING!

Refer to Safety chapters.

i For the Minute Minder function the display shows the time left.

3. When the time ends the indicator of the clock function flashes and an acoustic signal sounds. Press a button to stop the signal.
4. Turn the knob for the oven functions and the knob for the temperature to the off position.

i With the Duration and End functions, the appliance deactivates automatically. The functions work only for the main oven.

Cancelling the clock functions

1. Press the again and again until the necessary function indicator flashes.

2. Press and hold .

The clock function goes out after some seconds.

Inserting the accessories

Wire shelf:

Push the shelf between the guide bars of the shelf support and make sure that the feet point down.

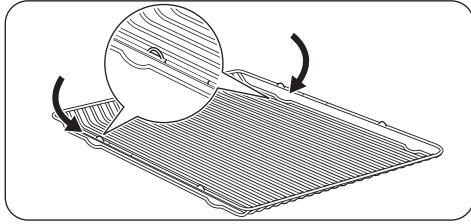

Deep pan:

Push the deep pan between the guide bars of the shelf support.

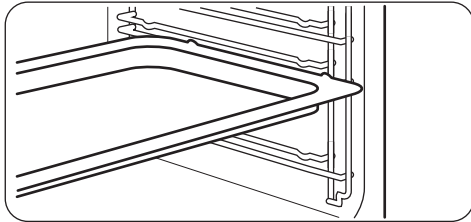

Wire shelf and the deep pan together:

Push the deep pan between the guide bars of the shelf support and the wire shelf on the guide bars above.

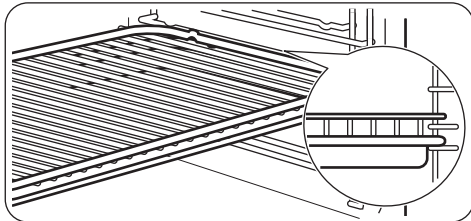

- All accessories have small indentations at the top of the right and left side to increase safety. The indentations are also anti-tip devices.
- The high rim around the shelf is a device which prevents cookware from slipping.

Trivet and Grill- / Roasting pan



WARNING!

Be careful when you remove the accessories from a hot appliance. There is a risk of burns.

You can use the trivet to roast larger pieces of meat or poultry on one shelf position.

1. Put the trivet into the deep pan so that the supports of the wire shelf point up.

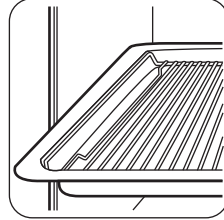

2. Put the deep pan into the oven on the necessary shelf position.

You can use the trivet to grill flat dishes in large quantities and to toast.

1. Put the trivet into the deep pan so that the supports of the wire shelf point down.

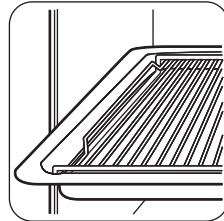

2. Put the deep pan into the oven on the necessary shelf position.

Additional functions

Cooling fan

When the appliance operates, the cooling fan activates automatically to keep the surfaces of

the appliance cool. If you deactivate the appliance, the cooling fan can continue to operate until the appliance cools down.

Hints and tips



WARNING!

Refer to Safety chapters.



The temperature and baking times in the tables are guidelines only. They depend on the recipes and the quality and quantity of the ingredients used.

Double oven

Top oven

The top oven is the smaller of the two ovens. It has 4 shelf positions. Use it to cook smaller quantities of food. It gives especially good results when used to cook fruitcakes, sweets and savoury flants or quiche.

Main oven

The main oven is the bigger of the two ovens. It is particularly suitable for cooking larger quantities of food.

Baking

- Your oven can bake or roast differently to the appliance you had before. Adapt your usual

settings (temperature, cooking times) and shelf positions to the values in the tables.

- The manufacturer recommends that you use the lower temperature the first time.
- If you cannot find the settings for a special recipe, look for the one that is almost the same.
- You can extend baking times by 10 – 15 minutes if you bake cakes on more than one shelf position.
- Cakes and pastries at different heights do not always brown equally at first. If this occurs, do not change the temperature setting. The differences equalize during the baking procedure.
- With longer baking times, you can deactivate the oven approximately 10 minutes before the end of the baking time and then use the residual heat.

When you cook frozen food, the trays in the oven can twist during baking. When the trays become cold again, the distortions are gone.

Tips on baking

Baking results	Possible cause	Remedy
The bottom of the cake is not browned sufficiently.	The shelf position is incorrect.	Put the cake on a lower shelf.
The cake sinks and becomes soggy, lumpy or streaky.	The oven temperature is too high.	The next time you bake, set a slightly lower oven temperature.
The cake sinks and becomes soggy, lumpy or streaky.	The baking time is too short.	Set a longer baking time. You cannot decrease baking times by setting higher temperatures.
The cake sinks and becomes soggy, lumpy or streaky.	There is too much liquid in the mixture.	Use less liquid. Be careful with mixing times, especially if you use a mixing machine.

Baking results	Possible cause	Remedy
The cake is too dry.	The oven temperature is too low.	The next time you bake, set a higher oven temperature.
The cake is too dry.	The baking time is too long.	The next time you bake, set a shorter baking time.
The cake browns unevenly.	The oven temperature is too high and the baking time is too short.	Set a lower oven temperature and a longer baking time.
The cake browns unevenly.	The mixture is unevenly distributed.	Spread the mixture evenly on the baking tray.
The cake is not ready in the baking time given.	The oven temperature is too low.	The next time you bake, set a slightly higher oven temperature.

Baking

To bake in the top oven use the function Conventional Cooking.

To bake in the main oven use the function True Fan Cooking.

Top oven

Food	Temperature (°C)	Time (min)	Shelf position
Biscuits	170 - 190	10 - 20	2
Bread	200 - 220	30 - 35	1
Bread rolls / buns	170-180	10 - 15	1
Cakes:			
- Small & Queen	160 - 170	18 - 25	2
- Sponges	160 - 175	20 - 30	2
- Victoria Sandwich	160 - 170	18 - 25	2
- Madeira	140 - 150	75 - 90	2
- Rich Fruit	140 - 150	120 - 150	2
- Gingerbread	140 - 150	75 - 90	2
- Meringues	90 - 100	150 - 180	2
- Flapjack	160 - 170	25 - 30	2
- Shortbread	130 - 150	45 - 65	2
Casseroles:			
- Beef / Lamb	160 - 170	150 - 180	1
- Chicken	160 - 180	75 - 90	1
Convenience Foods	Follow manufacturer's instructions.		

Food	Temperature (°C)	Time (min)	Shelf position
Fish	170 - 190	20 - 30	2
Fish Pie (Potato Topped)	190 - 200	20 - 30	2
Fruit Pies, Crumbles	190 - 200	30 - 50	2
Milk Puddings	150 - 170	90 - 120	2
Pasta, Lasagne etc.	170 - 180	40 - 50	2
Pastry:			
- Choux	180 - 190	30 - 40	2
- Eclairs, Profiteroles	180 - 190	30 - 40	2
- Flaky / Puff Pies	210 - 220	30 - 40	2
Shortcrust:			
- Mince Pies	190 - 210	15 - 20	2
- Meat Pies	190 - 210	25 - 35	2
- Quiche, Tarts, Flans	180 - 200	25 - 50	2
Scones	220 - 230	8 - 12	2
Shepard's Pie	180 - 190	30 - 40	2
Souffles	190 - 200	20 - 30	2
Vegetables:			
- Baked Jacket Potatoes	180 - 190	60 - 90	2
- Roast Potatoes	180 - 190	60 - 90	2
Yorkshire Pudding:			
- Large	200 - 210	25 - 40	1
- Individual	210 - 220	15 - 25	1

Main oven

Food	Temperature (°C)	Time (min)	Shelf position
Biscuits	180 - 190	10 - 20	3
Bread	190 - 210	30 - 35	3
Cakes:			
- Small & Queen	160 - 170	18 - 25	3
- Sponges	160 - 170	20 - 25	3
- Madeira	140 - 160	60 - 75	3

Food	Temperature (°C)	Time (min)	Shelf position
- Rich Fruit	130 - 140	120 - 150	3
- Christmas	130 - 140	180 - 270	3
Fish	160 - 180	20 - 30	3
Fish Pies, Crumbles	170 - 180	30 - 50	3
Milk Puddings	140 - 160	60 - 90	3
Pastry:			
- Choux	180 - 190	30 - 40	3
- Shortcrust	180 - 190	25 - 35	3
- Flaky	180 - 190	30 - 40	3
- Puff	Follow manufacturer's instructions. Reduce the temperature by 20°C.		
Plate Tarts	180 - 190	25 - 45	3
Quiches / Flans	170 - 180	25 - 45	3
Scones	210 - 230	8 - 12	3

Roasting

- Use heat-resistant ovenware to roast (refer to the instructions of the manufacturer).
- You can roast large roasting joints directly in the deep pan (if present) or on the wire shelf above the deep pan.
- Roast lean meats in the roasting tin with the lid. This keeps the meat more succulent.
- All types of meat that can be browned or have crackling can be roasted in the roasting tin without the lid.
- We recommend that you cook meat and fish weighing 1 kg and above in the appliance.
- To prevent the meat juices or fat from burning onto the pan, put some liquid into the deep pan.
- If necessary, turn the roast (after 1/2 - 2/3 of the cooking time).
- Baste large roasts and poultry with their juices several times during roasting. This gives better roasting results.
- You can deactivate the appliance approximately 10 minutes before the end of the roasting time, and use the residual heat.

Grilling

Always grill with the maximum temperature setting.

Set the shelf into the shelf position as recommended in the grilling table.

For grilling in the top oven adjust the shelf position to suit different thicknesses of food.

Always set the pan to collect the fat into the first shelf position.

Grill only flat pieces of meat or fish.

Always preheat the empty oven with the grill functions for 5 minutes.



CAUTION!

Always grill with the oven door closed.

Grilling and Fast Grilling - Top oven

Food	Time (min)
Bacon Rashers	5 - 6
Beefburgers	10 - 20
Chicken Joints	20 - 40
Lamb Chops	15 - 25
Pork Chops	20 - 25
Whole Fish, Trout / Makarel	10 - 12
Fillets, Plaice / Cod	4 - 6
Kebabs	12 - 18
Kidneys, Lamb / Pig	6 - 10
Sausages	20 - 30
Toasted Sandwiches	3 - 4
Steaks:	
- Rare	4 - 6
- Medium	6 - 8
- Well Done	12 - 15

Defrost - Main oven

Remove the food packaging and put the food on a plate.

Use the first shelf position from the bottom.

Do not cover the food with a bowl or a plate, as this can extend the defrost time.

Food	Quantity	Defrosting time (min)	Further defrosting time (min)	Comments
Chicken	1 kg	100 - 140	20 - 30	Put the chicken on an upturned saucer in a big plate. Turn halfway through.
Meat	1 kg	100 - 140	20 - 30	Turn halfway through.
Meat	500 g	90 - 120	20 - 30	Turn halfway through.
Trout	150 g	25 - 35	10 - 15	-
Strawberries	300 g	30 - 40	10 - 20	-
Butter	250 g	30 - 40	10 - 15	-

Food	Quantity	Defrosting time (min)	Further defrosting time (min)	Comments
Cream	2 x 200 g	80 - 100	10 - 15	Whip the cream when still slightly frozen in places.
Gateau	1.4 kg	60	60	-

Care and cleaning



WARNING!

Refer to Safety chapters.

Notes on cleaning

- Clean the front of the appliance with a soft cloth with warm water and a cleaning agent.
- To clean metal surfaces, use a usual cleaning agent.
- Clean the appliance interior after each use. Fat accumulation or other food remains may result in a fire. The risk is higher for the grill pan.
- Clean stubborn dirt with a special oven cleaner.
- Clean all accessories after each use and let them dry. Use a soft cloth with warm water and a cleaning agent.
- If you have nonstick accessories, do not clean them using aggressive agents, sharp-edged objects or a dishwasher. It can cause damage to the nonstick coating.

Stainless steel or aluminium appliances



Clean the oven door with a wet sponge only. Dry it with a soft cloth. Do not use steel wool, acids or abrasive materials as they can damage the oven surface. Clean the oven control panel with the same precautions.

Removing the shelf supports

To clean the oven, remove the shelf supports.

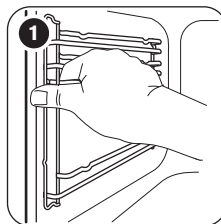

- 1 Pull the front of the shelf support away from the side wall.

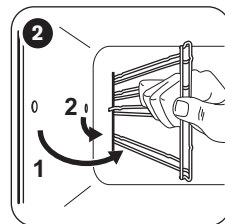

- 2 Pull the rear end of the shelf support away from the side wall and remove it.

Install the shelf supports in the opposite sequence.

Oven ceiling



WARNING!

Deactivate the appliance before you remove the heating element. Make sure that the appliance is cold. There is a risk of burns.

Remove the shelf supports.

You can fold down the heating element on the oven ceiling to clean the oven ceiling easily.

1. Hold the heating element with two hands at the front.
2. Pull it forwards against the spring pressure and out along the supports on the two sides.

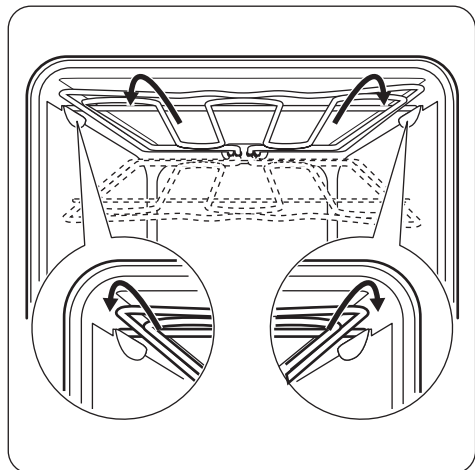

The heating element folds down.

3. Clean the oven ceiling.
4. Install the heating element in the opposite sequence.

i Install the heating element correctly above the supports on the inner walls of the appliance.

5. Install the shelf supports.

Removing and installing the door

You can remove the door and the internal glass panels to clean it. The number of glass panels is different for different models.

! **WARNING!**
Be careful when you remove the door from the appliance. The door is heavy.

1. Open the door fully.
2. Fully lift up the clamping levers (A) on the two door hinges.

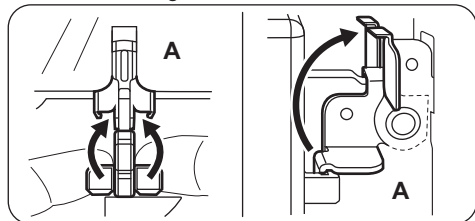

3. Close the door until it is at an angle of approximately 45°.

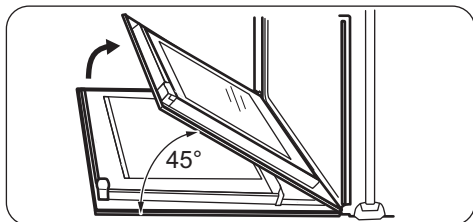

4. Hold the door with one hand on each side and pull it away from the appliance at an upwards angle.
5. Put the door with the outer side down on a soft cloth on a stable surface. This is to prevent scratches.
6. Hold the door trim (B) on the top edge of the door at the two sides and push inwards to release the clip seal.

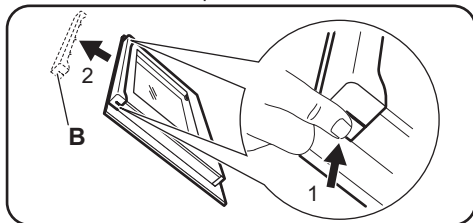

! **CAUTION!**
Rough handling of the glass, especially around the edges of the front panel, can cause the glass to break.

7. Pull the door trim to the front to remove it.
8. Hold the door glass panels on their top edge one by one and pull them up out of the guide.

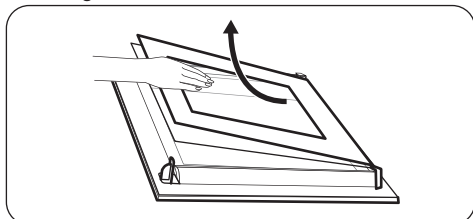

9. Clean the glass panel with water and soap. Dry the glass panel carefully. When the cleaning is completed, install the glass panels and the door. Do the above steps in the opposite sequence. Install the smaller panel first, then the larger.

Replacing the lamp

Put a cloth on the bottom of the interior of the appliance. It prevents damage to the lamp glass cover and the cavity.



WARNING!

Danger of electrocution! Disconnect the fuse before you replace the lamp.

The lamp and the lamp glass cover can be hot.

1. Deactivate the appliance.
2. Remove the fuses from the fuse box or deactivate the circuit breaker.

The back lamp



The lamp glass cover is at the back of the cavity.

1. Turn the lamp glass cover counterclockwise to remove it.
2. Clean the glass cover.
3. Replace the oven lamp with a suitable 300 °C heat-resistant oven lamp. Use the same oven lamp type.
4. Install the glass cover.

Troubleshooting



WARNING!

Refer to Safety chapters.

What to do if...

Problem	Possible cause	Remedy
The cooking zones do not operate.	Refer to the operating instructions for the built-in cooking surface.	
The oven does not heat up.	The oven is deactivated.	Activate the oven.
The oven does not heat up.	The clock is not set.	Set the clock.
The oven does not heat up.	The necessary settings are not set.	Make sure that the settings are correct.
The oven does not heat up.	The fuse is released.	Make sure that the fuse is the cause of the malfunction. If the fuse releases again and again, contact a qualified electrician.
The lamp does not operate.	The lamp is defective.	Replace the lamp.
Steam and condensation settle on the food and in the cavity of the oven.	You left the dish in the oven for too long.	Do not leave the dishes in the oven for longer than 15 - 20 minutes after the cooking process ends.
The display shows "12.00".	There was a power cut.	Reset the clock.

Service data

If you cannot find a solution to the problem yourself, contact your dealer or an Authorised Service Centre.

The necessary data for the service centre is on the rating plate. The rating plate is on the front frame of the appliance cavity. Do not remove the rating plate from the appliance cavity.

We recommend that you write the data here:

Model (MOD.)
Product number (PNC)
Serial number (S.N.)

Energy efficiency

Product Fiche and information according to EU 65-66/2014

Supplier's name	Zanussi
Model identification	ZOE35511XK
Energy Efficiency Index	Top oven: 106.8 Main oven: 106.6
Energy efficiency class	Top oven: A Main oven: A
Energy consumption with a standard load, conventional mode	Top oven: 0.78 kWh/cycle Main oven: not applicable
Energy consumption with a standard load, fan-forced mode	Top oven: not applicable Main oven: 0.81 kWh/cycle
Number of cavities	2
Heat source	Electricity
Volume	Top oven: 42 l Main oven: 46 l
Type of oven	Built-Under Oven
Mass	47.0 kg

EN 60350-1 - Household electric cooking appliances - Part 1: Ranges, ovens, steam ovens and grills - Methods for measuring performance.

Energy saving

The appliance contains features which help you save energy during everyday cooking.

General hints

- Make sure that the oven door is closed properly when the appliance operates and keep it closed as much as possible during the cooking.
- Use metal dishes to improve the energy saving.

- When possible, put the food inside the oven without heating it up.
- When the cooking duration is longer than 30 minutes, reduce the oven temperature to minimum, 3 - 10 minutes before the end of the cooking time, depending on the duration of the cooking. The residual heat inside the oven will continue to cook.
- Use the residual heat to warm up other foods.
- **Cooking with fan** - when possible, use the cooking functions with fan to save energy.
- **Keep food warm** - if you want to use the residual heat to keep the meal warm, choose the lowest possible temperature setting.

ENVIRONMENT CONCERNS

Recycle the materials with the symbol . Put the packaging in applicable containers to recycle it. Help protect the environment and human health and to recycle waste of electrical and electronic appliances. Do not dispose

appliances marked with the symbol  with the household waste. Return the product to your local recycling facility or contact your municipal office.



www.zanussi.com/shop



867300154-A-452014