

BOSCH

**Use and Care Manual
For Household Use Only
Notice d'utilisation et d'entretien
Usage domestique uniquement
Manual de instrucciones y cuidado
sólo para uso doméstico**

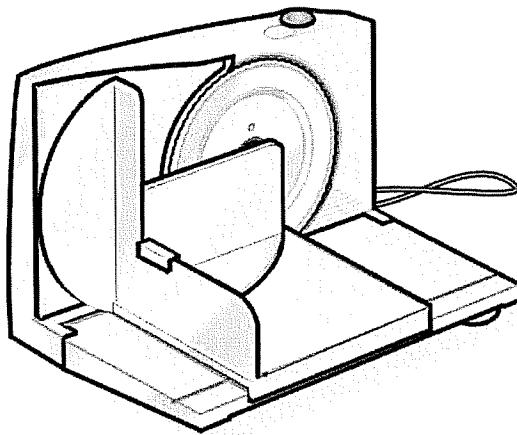

MS 4200

Slicer



Use and Care Manual **3**

READ THIS MANUAL thoroughly for important safety and operating instructions before using this appliance.

Notice d'utilisation et d'entretien **xx**

Avant tout utilisation, **LISEZ ATTENTIVEMENT** ce manuel, vous y trouverez des consignes importantes portant sur la sécurité et le fonctionnement de votre appareil.

Manual de instrucciones y cuidado **xx**

LEA ESTAS INSTRUCCIONES cuidadosamente por las instrucciones importantes de seguridad y funcionamiento antes de utilizar el electrodoméstico.

IMPORTANT SAFEGUARDS

READ AND SAVE THESE INSTRUCTIONS HOUSEHOLD USE ONLY

When using an electrical appliance, basic safety precautions should always be followed, including the following:

- READ ALL INSTRUCTIONS BEFORE USING THE APPLIANCE.
- To protect against risk of electrical shock, do not put power unit of this appliance in water or other liquid.
- Close supervision is necessary when any appliance is used by or near children.
- Unplug from outlet when not in use, before putting on or taking off parts, and before cleaning.
- Avoid contacting moving parts. Never feed food by hand. Always use completely assembled slicer with food platform and food grip.
- Blade is sharp. Handle carefully when cleaning.
- Do not operate any appliance with a damaged cord or plug, or after the appliance malfunctions or is dropped or damaged in any manner. Return appliance to the nearest authorized service facility for examination, repair or electrical or mechanical adjustment.
- The use of attachments not recommended or sold by the appliance manufacturer may cause fire, electrical shock or injury.
- Do not use outdoors.
- Do not let cord hang over edge of table or counter or touch hot surfaces.

Note: This appliance has a polarized plug (one prong is wider than the other). As a safety feature, this plug will fit into a polarized outlet only one way. If the plug does not fill fully into the outlet, reverse the plug. If it still does not fit, contact a qualified electrician. Do not modify the plug in any way.

Your new slicer

Congratulations on having selected a Bosch slicer. A Bosch universal slicer that we feel are the best available.

The Bosch slicer features:

- adjustable cutting width
- safety button to prevent injury
- stainless steel circular blade

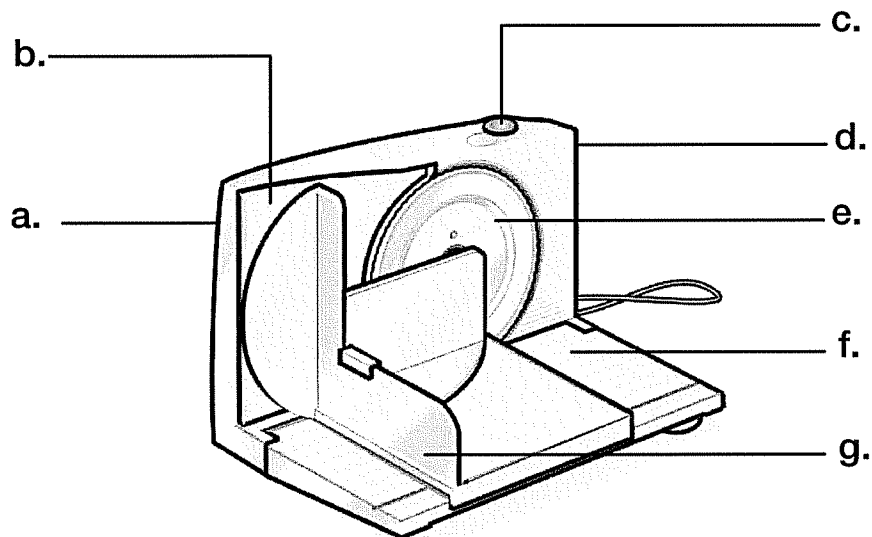

- a. turning knob
- b. stop plate
- c. switch
- d. safety button
- e. stainless steel, circular blade
- f. table
- g. folding carriage

Operating the appliance

⚠ Attention!

This appliance is designed for domestic use only.

Please keep the operating instructions.

If passing on the appliance to a third party, always include the operating instructions.

Preparing

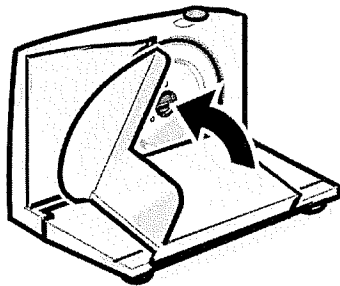
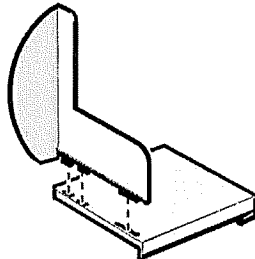
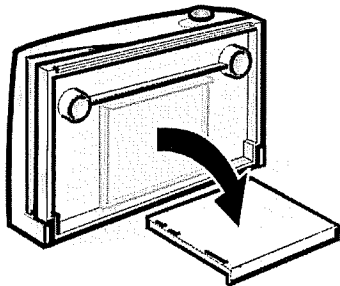

1. Clean the appliance before using for the first time.
2. Assemble folding carriage, insert diagonally from the right in the lateral guide rail and then place on the table.

3. Pull the cord out of the housing and insert the plug into outlet.

Operating

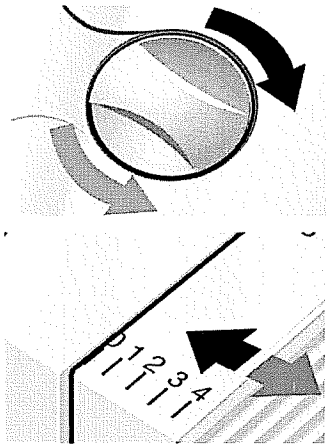

4. Use the turning knob to set the cutting width.

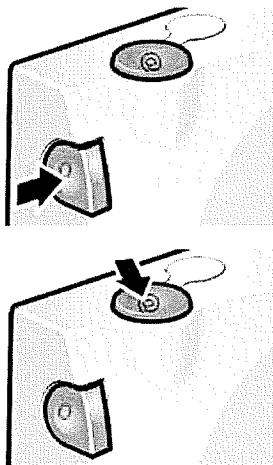

5. Switch on the appliance:

Press safety button, then

Press on switch. You can now release the safety button.
The device switches off if the on button is released.

⚠ Attention! The sharp knife may cause injury!
*The blade continues to rotate for a moment.
Keep your hands well away from the blade.*

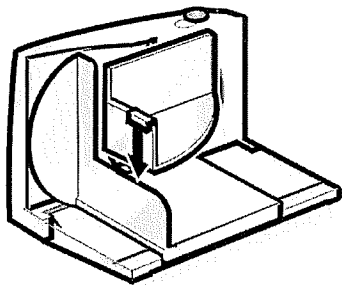

6. Insert retainer.

⚠ Always use the folding carriage and the retainer!

⚠ Cutting food without the retainer may cause injury!

The retainer may only be removed when cutting food with a size and form that would not permit the use of a folding carriage and retainer.

Tip: First cut sausage and cheese, then bread.
This makes it easier to clean the device.

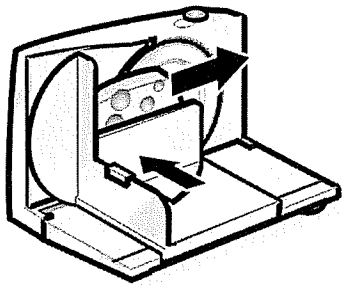

⚠ Attention! Motor may overheat!

Allow the device to cool down after uninterrupted operation of max. 5 min.

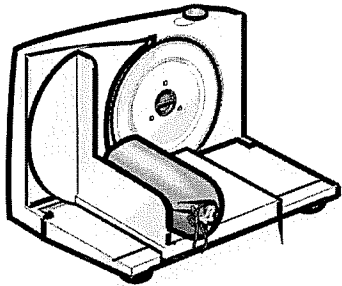

7. Fold the device away after use and immediate cleaning.

8. Wind up cord and lock in plug.

Keep device away from children.

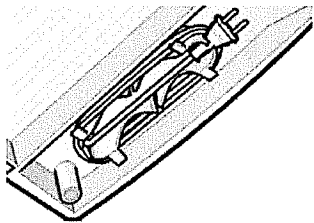

Cleaning and servicing

⚠ Warning!

Never immerse the appliance in water and do not clean in the dishwasher.

⚠ Warning!

The sharp blade may cause injury!

Pull the plug out and remove the blade before cleaning. Only touch the blade holder. Never touch the cutting edge.

Note: Do not use abrasive cleaning agents as these will damage the surfaces.

1. Pull out the plug.
2. Wipe the device and accessories with a damp cloth and leave to dry.

Clean circular blade

Always clean the circular blade thoroughly by hand immediately after use.

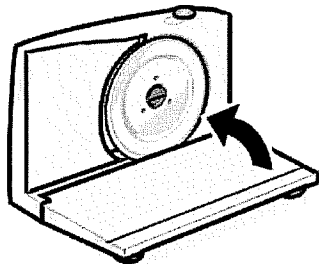

1. Fold the table upwards.

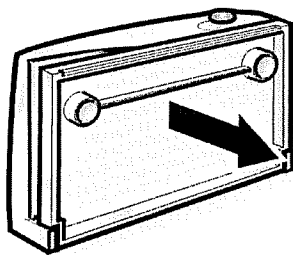

2. Pull to the right to remove the table from the hinge.

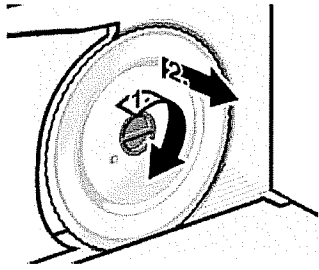

3. Turn the blade holder clockwise, place vertically and remove the circular blade.
4. Clean it carefully.

5. Make sure it locks correctly upon re-assembly: blade holder is always horizontal.

⚠ Warning!

A blade falling out may cause injury!

Thorough Cleaning

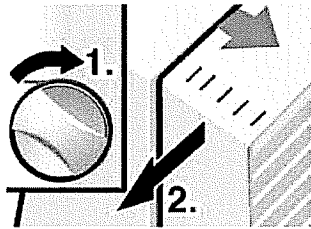

1. Remove the stop plate.
 - Turn the turning knob beyond the 0 setting.
 - Pull out the stop plate.
2. Clean the appliance thoroughly.
3. Refit the plate.
 - Lightly press it inwards. The turning knob must be in the position beyond the 0 setting.
 - Turn the turning knob back.

The device is otherwise maintenance-free.

BSH Home Appliances Corporation
5551 McFadden Avenue
Huntington Beach, CA 92649
USA

Web site: www.boschsmallappliances.com

Customer Service (toll free): 1-866-44BOSCH (1-866-442-6724)

Appelez le service-client (gratuit) : 1-866-44BOSCH (1-866-442-6724)

Servicio al cliente (libre de cargo): 1-866-44BOSCH (1-866-442-6724)

0203
509045????