

# USER MANUAL

# *ProLite*

## LCD Monitor

ENGLISH

*ProLite XB2472HD*  
*ProLite X2472HD*

Thank you very much for choosing the iiyama LCD monitor.

We recommend that you take a few minutes to read this comprehensive manual carefully before installing and switching on the monitor. Please keep this manual in a safe place for your future reference.





## Dear user, we congratulate you on the purchase of your iiyama LCD.

For details on warranty and locally used pixel policies that apply directly after installation of your product please check the iiyama website.

## To report a fault, please contact your local support centre found at [www.iiyama.com/service](http://www.iiyama.com/service)

### Things to check before you call the iiyama information line

- | if the power cable is connected securely and turned on?
- | if the display has been turned on?
- | if the signal cable is connected securely and the correct input selected?
- | if the computer has been restarted with the display connected?
- | if the graphics card is correctly installed with the latest drivers possible?
- | if the correct native resolution has been selected via 'Display Properties'?
- | If the R/G/B signal configuration is correct?
- | if the displays On Screen Menu is shown?
- | if the correct brightness and contrast settings have been set?
- | if given display tolerances and compatibility have been considered?
- | if via the On Screen Menu you have performed a Factory Reset/Recall?

### Before reporting the screen defect, please prepare the following information/evidence:

- | model number \*
- | purchase receipt and serial number \*
- | name and address for collection
- | telephone/fax number, for availability during the day
- | convenient collection date (date, time)
- | short description of the defect

### Important Note:

If there is no fault found in the collected equipment after inspection, the transferring party shall incur charges for transport and administration.

If you have checked all of the above and there is still no picture, call our information line for assistance in your country.

\* see the identification plate on the back of the case.

## CE MARKING DECLARATION OF CONFORMITY

This LCD monitor complies with the requirements of the EC Directive 2004/108/EC "EMC Directive", 2006/95/EC "Low Voltage Directive" and 2009/125/EC "ErP Directive".

The electro-magnetic susceptibility has been chosen at a level that gives correct operation in residential areas, business and light industrial premises and small-scale enterprises, inside as well as outside of the buildings. All places of operation are characterised by their connection to the public low voltage power supply system.

IYYAMA CORPORATION: Breguetlaan 8, 1438BC Oude Meer The Netherlands



We recommend recycling of used product. Please contact your dealer or iiyama service center. Recycle information is obtained via the Internet, using the address: <http://www.iiyama.com>

You can access the Web page of different countries from there.

- We reserve the right to change specifications without notice.
- All trademarks used in this user manual are the property of their respective owners.
- As an ENERGY STAR® Partner, iiyama has determined that this product meets the ENERGY STAR® guidelines for energy efficiency.

# TABLE OF CONTENTS

FOR YOUR SAFETY .....	1
SAFETY PRECAUTIONS.....	1
SPECIAL NOTES ON LCD MONITORS .....	3
CUSTOMER SERVICE .....	3
CLEANING .....	3
BEFORE YOU OPERATE THE MONITOR .....	4
FEATURES.....	4
CHEKING THE CONTENTS OF THE PACKAGE .....	4
FITTING AND REMOVAL OF BASE : ProLite X2472HD .....	5
CONTROLS AND CONNECTORS : ProLite XB2472HD .....	6
CONTROLS AND CONNECTORS : ProLite X2472HD.....	7
CONNECTING YOUR MONITOR : ProLite XB2472HD.....	8
CONNECTING YOUR MONITOR : ProLite X2472HD .....	9
COMPUTER SETTING .....	10
ADJUSTING THE VIEWING ANGLE : ProLite X2472HD .....	10
ADJUSTING THE HEIGHT AND THE VIEWING ANGLE :	
ProLite XB2472HD .....	11
PANEL ROTATION : ProLite B2472HD .....	11
OPERATING THE MONITOR.....	12
ADJUSTMENT MENU CONTENTS .....	13
SCREEN ADJUSTMENTS .....	18
POWER MANAGEMENT FEATURE.....	21
TROUBLE SHOOTING .....	22
RECYCLING INFORMATION.....	23
APPENDIX .....	24
SPECIFICATIONS : ProLite XB2472HD .....	24
SPECIFICATIONS : ProLiteX2472HD .....	25
DIMENSIONS : ProLite XB2472HD .....	26
DIMENSIONS : ProLite X2472HD .....	26
COMPLIANT TIMING .....	26



# FOR YOUR SAFETY

## SAFETY PRECAUTIONS

### WARNING

#### **STOP OPERATING THE MONITOR IF YOU ARE AWARE OF ANY PROBLEMS**

If you notice any abnormal phenomena such as smoke, strange sounds or fumes, unplug the monitor and contact your dealer or iiyama service center immediately. Further use may be dangerous and can cause fire or electric shock.

#### **NEVER REMOVE THE CABINET**

High voltage circuits are inside the monitor. Removing the cabinet may expose you to the danger of fire or electric shock.

#### **DO NOT PUT ANY OBJECT INTO THE MONITOR**

Do not put any solid objects or liquids such as water into the monitor. In case of an accident, unplug your monitor immediately and contact your dealer or iiyama service center. Using the monitor with any object inside may cause fire, electric shock or damage.

#### **INSTALL THE MONITOR ON A FLAT, STABLE SURFACE**

The monitor may cause an injury if it falls or is dropped.

#### **DO NOT USE THE MONITOR NEAR WATER**

Do not use where water may be splashed or spilt onto the monitor as it may cause fire or electric shock.

#### **OPERATE UNDER THE SPECIFIED POWER SUPPLY**

Be sure to operate the monitor only with the specified power supply. Use of an incorrect voltage will cause malfunction and may cause fire or electric shock.

#### **CORRECT USE OF THE AC ADAPTER**

Use only the AC Adapter provided by iiyama. Any deviation from this by using another type of adapter may result in damage to the accessory and the monitor by fire or electric shock.

#### **DO NOT DISASSEMBLE THE AC ADAPTER**

Disassembling the AC Adapter may expose you to the danger of fire or electric shock.

#### **PROTECT THE CABLES**

Do not pull or bend the AC adapter, the power cable and signal cable. Do not place the monitor or any other heavy objects on the cables. If damaged, the cables may cause fire or electric shock.

#### **ADVERSE WEATHER CONDITIONS**

It is advisable not to operate the monitor during a heavy thunder storm as the continual breaks in power may cause malfunction. It is also advised not to touch the plug in these circumstances as it may cause electric shock.

## CAUTION

### INSTALLATION LOCATION

Do not install the monitor where sudden temperature changes may occur, or in humid, dusty or smoky areas as it may cause fire, electric shock or damage. You should also avoid areas where the sun shines directly on the monitor.

### DO NOT PLACE THE MONITOR IN A HAZARDOUS POSITION

The monitor may topple and cause injury if not suitably located. Please also ensure that you do not place any heavy objects on the monitor, and that all cables are routed such that children may not pull the cables and possibly cause injury.

### MAINTAIN GOOD VENTILATION

Ventilation slots are provided to keep the monitor from overheating. Covering the slots may cause fire. To allow adequate air circulation, place the monitor at least 10 cm (or 4 inches) from any walls. Do not remove the tilt stand when operating the monitor. Ventilation slots on the back of the cabinet will be blocked and the monitor may overheat if the stand is removed. This may cause fire or damage. Operating the monitor on its back, side, upside down or on a carpet or any other soft material may also cause damage.

### DISCONNECT THE CABLES WHEN YOU MOVE THE MONITOR

When you move the monitor, turn off the power switch, unplug the monitor and be sure the signal cable is disconnected. If you do not disconnect them, it may cause fire or electric shock.

### UNPLUG THE MONITOR

If the monitor is not in use for a long period of time it is recommended that it is left unplugged to avoid accidents.

### HOLD THE PLUG WHEN DISCONNECTING

To disconnect the power cable or signal cable, always pull it by the plug. Never pull on the cable itself as this may cause fire or electric shock.

### HOLD THE PLUG WHEN DISCONNECTING

To disconnect the AC adapter, the power cable or signal cable, always pull it by the plug. Never pull on the cable itself as this may cause fire or electric shock.

### DO NOT TOUCH THE PLUG WITH WET HANDS

Pulling or inserting the plug with wet hands may cause electric shock.

### WHEN YOU INSTALL THE MONITOR ON YOUR COMPUTER

Be sure the computer is strong enough to hold the weight of the monitor, otherwise, you may damage your computer.

### CAREFUL! PROTECT YOUR HANDS AND FINGERS

- Be careful not to hurt your fingers or hands when you change the height or the angle.
- Injury can occur if care is not taken to avoid finger contact with the displays base when adjusting the height. (Just for height adjustable model.)

## OTHERS

### ERGONOMIC RECOMMENDATIONS

To eliminate eye fatigue, do not operate the monitor against a bright background or in a dark room. For optimal viewing comfort, the monitor should be just below eye level and 40-60 cm (16-24 inches) away from your eyes. When using the monitor over a prolonged time, a ten minute break every hour is recommended as looking at the screen continuously can cause eye strain.

## SPECIAL NOTES ON LCD MONITORS

The following symptoms are normal with LCD monitors and do not indicate a problem.

### NOTE

- When you first turn on the LCD monitor, the picture may not fit in the display area because of the type of computer that is used. In this case, adjust the picture position to the correct position.
- Due to the nature of the backlight, the screen may flicker during initial use. Turn off the Power Switch and then turn it on again to make sure the flicker disappears.  
You may find slightly uneven brightness on the screen depending on the desktop pattern you use.
- Due to the nature of the LCD screen, an afterimage of the previous screen may remain after switching the image, when the same image is displayed for hours. In this case, the screen can be recovered slowly by changing the image or turning off the Power Switch for some hours.
- Contact your dealer or iiyama service center for the backlight replacement when the screen is dark, flickering or not lighting up. Never attempt to replace it by yourself.

## CUSTOMER SERVICE

### NOTE

- If you have to return your unit for service and the original packaging has been discarded, please contact your dealer or iiyama service center for advice or replacement packaging.

## CLEANING

### WARNING

- If you drop any materials or liquids such as water into the monitor when cleaning, unplug the power cable immediately and contact your dealer or iiyama service center.

### CAUTION

- For safety reasons, turn off the power switch and unplug the monitor before you clean it.

### NOTE

- To protect the LCD panel, do not scratch or rub the screen with a hard object.
- Never use any of the following strong solvents. These will damage the cabinet and the LCD screen.

Thinner	Spray-type cleaner
Benzine	Wax
Abrasive cleaner	Acid or Alkaline solvent

- Touching the cabinet with any product made from rubber or plastic for a long time may cause degeneration or loss of paint on the cabinet.

### CABINET

Stains can be removed with a cloth lightly moistened with a mild detergent solvent. Then wipe the cabinet with a soft dry cloth.

### LCD SCREEN

Periodic cleaning with a soft dry cloth is recommended.

Don't use tissue paper etc. because these will damage the LCD screen.



## BEFORE YOU OPERATE THE MONITOR

### FEATURES

- ◆ Supports Resolutions up to 1920 × 1080
- ◆ High Contrast 3000:1 (Typical), ACR Function Available / Brightness 250cd/m<sup>2</sup> (Typical)
- ◆ Quick Response Time 8ms (Gray to Gray)
- ◆ Digital Character Smoothing
- ◆ Automatic Set-up
- ◆ Plug & Play VESA DDC2B Compliant  
Windows<sup>®</sup> 95/98/2000/Me/XP/Vista/7 Compliant
- ◆ Power Management (ENERGY STAR<sup>®</sup> VESA DPMS Compliant)
- ◆ Keyhole for Security Lock

### CHECKING THE CONTENTS OF THE PACKAGE

The following accessories are included in your package. Check to see if they are enclosed with the monitor. If anything is missing or damaged, please contact your local iiyama dealer or regional iiyama office.

- |                            |  |                      |
|----------------------------|--|----------------------|
| ■ AC Adapter* <sup>1</sup> | ■ Power Cable* <sup>1</sup>                                  | ■ D-Sub Signal Cable |
| ■ DVI-D Cable              | ■ Stand-Base (Screw for stand fixing attached)* <sup>2</sup> |                      |
| ■ Safety Guide             | ■ Quick Start Guide  |                      |

#### CAUTION \*1 1. TO USERS IN 120V AREA

The rating of the Power Cable enclosed in 120V area is 10A/125V. If you are using a power supply higher than this rating, then a power cable with a rating of 10A/250V must be used. However, all guarantees and warranties are void for any problems or damage caused by a power cable or AC adapter not supplied by iiyama.

#### 2 Applicable AC Adapter

AC Adapter Type Name : DA-50F19 (Asian Power Device Inc.)

\*2 Accessory for ProLite X2472HD.

## FITTING AND REMOVAL OF BASE : ProLite X2472HD

### CAUTION

- Put the monitor on a stable surface. The monitor may cause injury or damage if it falls or is dropped.
- Do not give a strong impact to the monitor. It may cause damage.
- Unplug the monitor before removal or installation to avoid electric shock or damage.

### <Installation>

- ① Put a piece of soft cloth on the table beforehand to prevent the monitor from being scratched. Lay the monitor flat on a table with front face down.
- ② Install the Stand-Base to the Monitor.
- ③ Fix the Monitor to the Stand by screwing the push-down knob in firmly.

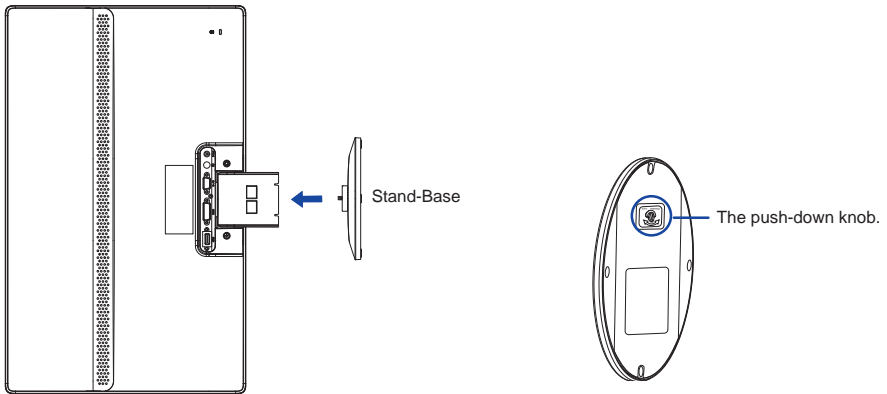

### <Removal>

- ① Put a piece of soft cloth on the table beforehand to prevent the monitor from being scratched. Lay the monitor flat on a table with front face down.
- ② Pull the knob upwards, then unfix the screw and remove the Stand-Base.

## CONTROLS AND CONNECTORS : ProLite XB2472HD

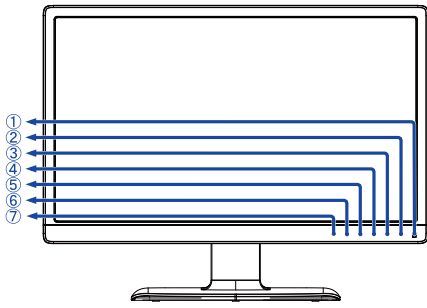

&lt;Front&gt;

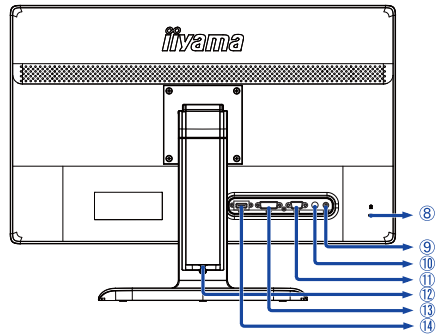

&lt;Back&gt;

- ① Power Indicator

**NOTE** Blue: Normal operation  
Orange: Power Management

- ② Power Switch (⏻)  
③ Menu / Select Button (ENTER)  
④ Scroll Up Button (▶)  
⑤ Scroll Down / ECO Mode Button\* (◀ / ⓪)  
⑥ Exit Button (EXIT)  
⑦ Auto Button (AUTO)  
⑧ Keyhole for Security Lock

**NOTE** You can fasten a security lock and cable to prevent the monitor from being removed without your permission.

- ⑨ Connector for AC Adapter (DC19V)  
⑩ Audio out Connector (Ⓛ-Ⓜ)  
⑪ D-SUB mini 15pin Connector (D-Sub)  
⑫ Cable Holder  
⑬ DVI-D 24pin Connector (DVI-D)  
⑭ HDMI Connector

\* You can skip the Menu items and display an adjustment scale directly.

**<Audio output>**

This Monitor does not have speakers.

To hear sound, please connect an external speakers or headphones.

## CONTROLS AND CONNECTORS : ProLite X2472HD

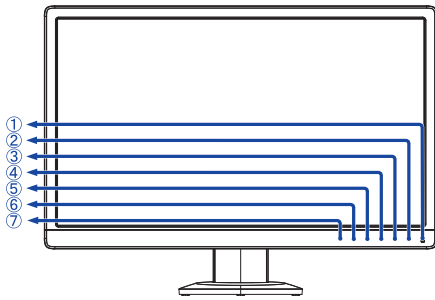

<Front>

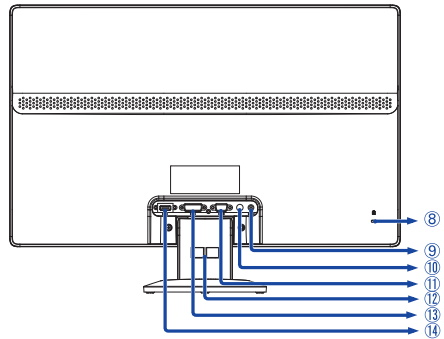

<Back>

### ① Power Indicator

**NOTE** Blue: Normal operation  
Orange: Power Management

### ② Power Switch (⏻)

### ③ Menu / Select Button (ENTER)

### ④ Scroll Up Button (▲)

### ⑤ Scroll Down / ECO Mode Button\* (▼ / ⓪)

### ⑥ Exit Button (EXIT)

### ⑦ Auto Button (AUTO)

### ⑧ Keyhole for Security Lock

**NOTE** You can fasten a security lock and cable to prevent the monitor from being removed without your permission.

### ⑨ Connector for AC Adapter (DC19V)

### ⑩ Audio out Connector (🔊)

### ⑪ D-SUB mini 15pin Connector (D-Sub)

### ⑫ Cable Holder

### ⑬ DVI-D 24pin Connector (DVI-D)

### ⑭ HDMI Connector

\* You can skip the Menu items and display an adjustment scale directly.

## <Audio output>

This Monitor does not have speakers.

To hear sound, please connect an external speakers or headphones.

## CONNECTING YOUR MONITOR : ProLite XB2472HD

- ① Ensure that both the computer and the monitor are switched off.
- ② Connect the computer to the monitor with the signal cable.
- ③ Connect the AC Adapter to the monitor and the Power Cable to the AC Adapter first and then connect to the power supply.
- ④ Turn on your monitor and computer.

### NOTE

- The signal cables used for connecting the computer and monitor may vary with the type of computer used. An incorrect connection may cause serious damage to both the monitor and the computer. The cable supplied with the monitor is for a standard 15 pin D-Sub connector. If a special cable is required please contact your local iiyama dealer or regional iiyama office.
- For connection to Macintosh computers, contact your local iiyama dealer or regional iiyama office for a suitable adaptor.
- Make sure you tighten the finger screws at each end of the signal cable.

[Example of Connection]

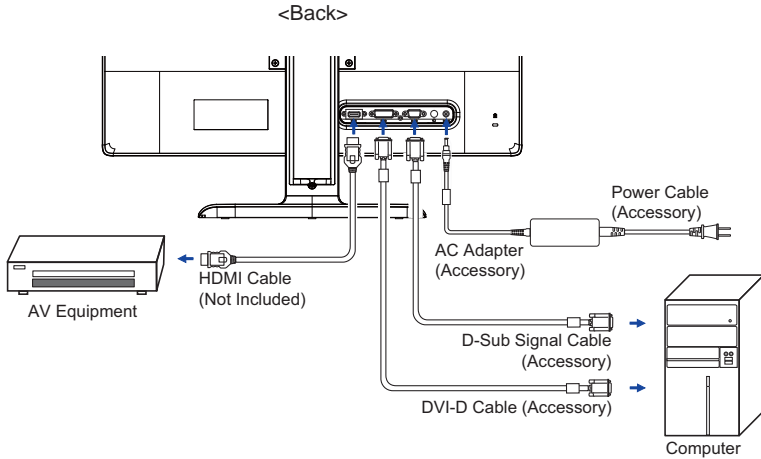

### [ Collect Cables ]

- ① Put the cables through the cable holder.
- ② Collect cables at the back of the stand.

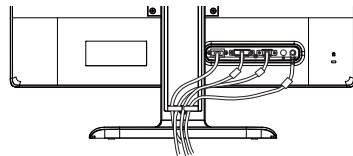

## CONNECTING YOUR MONITOR : ProLite X2472HD

- ① Ensure that both the computer and the monitor are switched off.
- ② Connect the computer to the monitor with the signal cable.
- ③ Connect the AC Adapter to the monitor and the Power Cable to the AC Adapter first and then connect to the power supply.
- ④ Turn on your monitor and computer.

### NOTE

- The signal cables used for connecting the computer and monitor may vary with the type of computer used. An incorrect connection may cause serious damage to both the monitor and the computer. The cable supplied with the monitor is for a standard 15 pin D-Sub connector. If a special cable is required please contact your local iiyama dealer or regional iiyama office.
- For connection to Macintosh computers, contact your local iiyama dealer or regional iiyama office for a suitable adaptor.
- Make sure you tighten the finger screws at each end of the signal cable.

[Example of Connection]

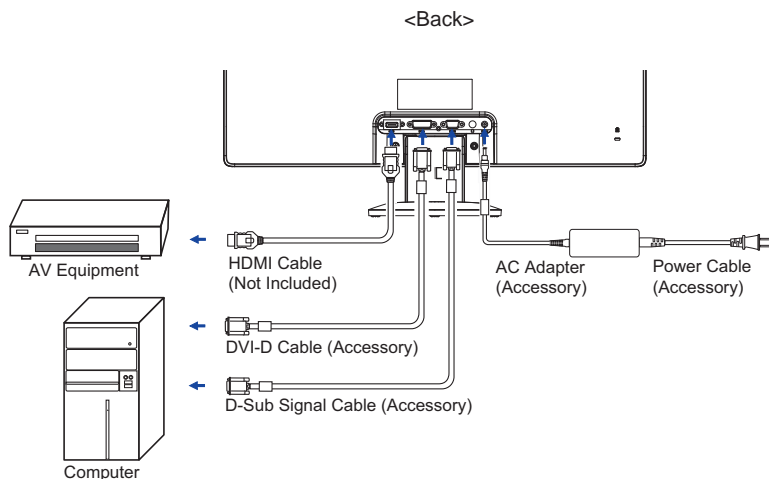

### [ Collect Cables ]

- ① Put the cables through the cable holder.
- ② Collect cables at the back of the stand.

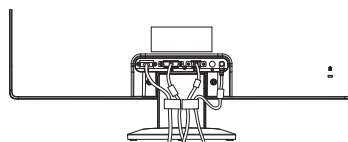

## COMPUTER SETTING

### ■ Signal Timing

Change to the desired signal timing listed on page 26: COMPLIANT TIMING.

### ■ Windows 95/98/2000/Me/XP/Vista/7 Plug & Play

The iiyama LCD monitor complies with DDC2B of VESA standard. The Plug & Play function runs on Windows 95/98/2000/Me/XP/Vista/7 by connecting the monitor to DDC2B compliant computer with the Signal Cable supplied.

For installation on Windows 95/98/2000/Me/XP: The monitor Information File for iiyama monitors may be necessary for your computer and obtained via the Internet, using the address:

<http://www.iiyama.com>

### NOTE

- For additional information on how to download the driver for your touch screen monitor, please access the internet site noted above.
- Monitor Drivers are not required in most cases for Macintosh or Unix operating systems. For further information, please contact your computer dealer first for advice.

## ADJUSTING THE VIEWING ANGLE : ProLite X2472HD

- For optimal viewing it is recommended to look at the full face of the monitor.
- Hold the stand so that the monitor does not topple when you change the monitor's angle.
- You are able to adjust the monitor's angle up to 15° upward, 5° downward.
- In order to ensure a healthy and relaxed body position when using the monitor at visual display workstations, it is recommended that the adjusted tilt angle should not exceed 10 degrees. Adjust the monitor's angle to your own preference.

### NOTE

- Do not touch the LCD screen when you change the angle. It may cause damage or break the LCD screen.
- Careful attention is required not to catch your fingers or hands when you change the angle.
- Do not tilt the post beyond 20 degrees except when repacking the monitor in its box. To do so may cause the monitor to fall over and break.

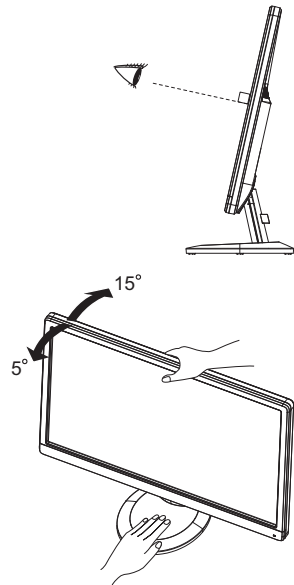

## ADJUSTING THE HEIGHT AND THE VIEWING ANGLE : ProLite XB2472HD

- For optimal viewing it is recommended to position yourself directly opposite to the full face of the monitor, then adjust the monitor's height and angle to your own preference.
- Hold the panel so that the monitor does not topple when you change the monitor's height or angle.
- You are able to adjust the monitor's height up to 130mm, angle up to 45 degrees right and left, 20 degrees upward, 5° downward.

### NOTE

- Do not touch the LCD screen when you change the height or the angle. It may cause damage or break the LCD screen.
- Careful attention is required not to catch your fingers or hands when you change the height or the angle.
- Injury can occur if care is not taken to avoid finger contact with the displays base when adjusting the height.

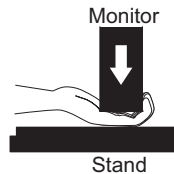
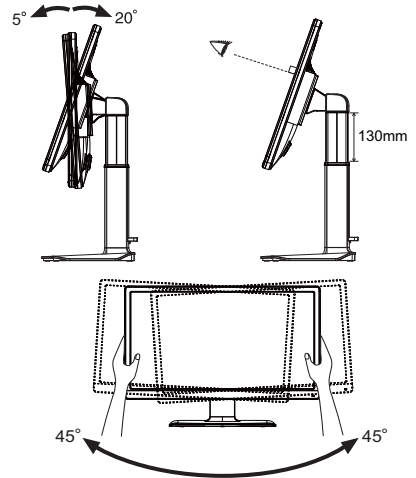

## PANEL ROTATION : ProLite XB2472HD

- ① Adjust the monitor's height.
- ② Rotate the panel 90 degrees.  
Portrait: Turn clockwise.  
Landscape: Turn counter clockwise.

- NOTE**
- Attempting to rotate without fully extending upward may cause damage to stand.
  - Video card for portrait display will be required for rotating the image on the screen.

- ③ Adjust the monitor's angle to your preference.

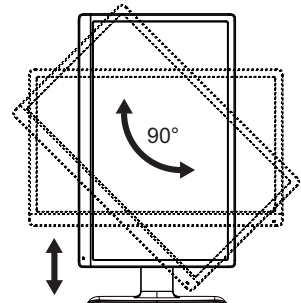





## OPERATING THE MONITOR

To create the best picture, your iiyama LCD monitor has been preset at the factory with the COMPLIANT TIMING shown on page 26. You are also able to adjust the picture by following the button operation shown below. For more detailed adjustments, see page 18 for SCREEN ADJUSTMENTS.

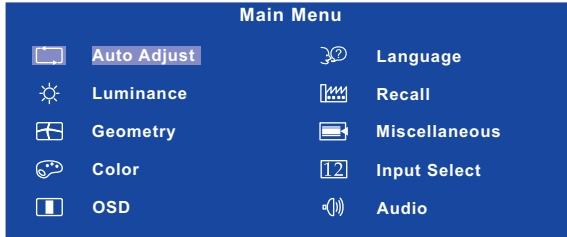
- 1 Press the ENTER Button to start the On Screen Display feature. There are additional Menu items which can be switched by using the ◀/ ▶ Buttons.



- 2 Select the Menu item which contains the adjustment icon relating to the adjustment you want to make. Press the ENTER Button. Then, use the ◀/ ▶ Buttons to highlight the desired adjustment icon.
- 3 Press the ENTER Button again. Use the ◀/ ▶ Buttons to make the appropriate adjustment or setting.
- 4 Press the EXIT Button to leave the menu, and the settings you just made would be automatically saved.

For example, to correct for vertical position, select Menu item of Geometry and then press the ENTER Button. Then, select  (V.Position) by using the ◀/ ▶ Buttons.

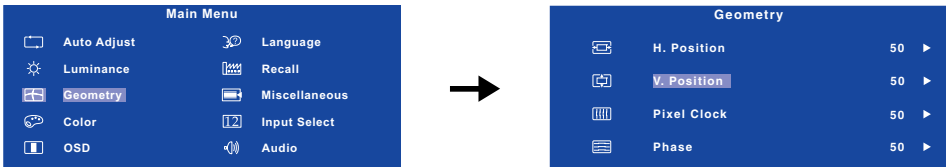

An adjustment page appears after you press the ENTER Button. Then, use the ◀/ ▶ Buttons to change the vertical position settings. The vertical position of the overall display should be changing accordingly while you are doing this.

Press the EXIT Button lastly, it ends, any changes are saved in the memory.

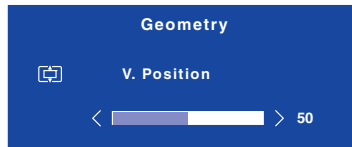

### NOTE

- When button operations are aborted during adjustment, On-Screen Display disappears when the time set for the OSD Time has passed. Also, press the EXIT button to quickly turn off the On-Screen Display.
- Any changes are automatically saved in the memory when the On Screen Display disappears. Turning off the power should be avoided while using the Menu.
- Adjustments for H. / V. Position, Pixel Clock and Phase are saved for each signal timing. Except for these adjustments, all other adjustments have only one setting which applies to all signal timings.

## ADJUSTMENT MENU CONTENTS











 <b>Auto Adjust</b>		Only Analog Input
Adjustment Item	Problem / Option	Button to Press
Auto Adjust * <b>Direct</b>	Adjust H. / V. Position, Pixel Clock and Phase automatically.	

\* For best results, use the Auto Adjust in conjunction with the adjustment pattern. See page 18 for SCREEN ADJUSTMENTS.

### Direct

You can skip the Menu items and display an adjustment scale directly by using the following button operations.

- Auto Adjust : Press the Auto Button when the Menu is not displayed.

 <b>Luminance</b> * <sup>1</sup>		
Adjustment Item	Problem / Option	Button to Press
 Brightness * <sup>2</sup> <b>Direct</b>	Too dark Too bright	   
 Contrast	Too dull Too intense	   



























\*<sup>1</sup> Luminance adjustment disabled when ACR mode is active.





\*<sup>2</sup> Adjust the Brightness when you are using the monitor in a dark room and feel the screen is too bright.

















### Direct

You can skip the Menu items and display an adjustment scale directly by using the following button operations.

- Brightness : Press the  Button when the Menu is not displayed.

 <b>Geometry</b> <span style="border: 1px solid black; padding: 2px;">Only Analog Input</span>		
Adjustment Item	Problem / Option	Button to Press
 H. Position	 Too left  Too right	   
 V. Position	 Too low  Too high	   
 Pixel Clock	 Too narrow  Too wide	   
 Phase	To correct flickering text or lines	   

 <b>Color</b>		
Adjustment Item	Problem / Option	Button to Press
9300K	Bluish white	
7500K	Yellowish white	
6500K	Reddish white	
User Preset	Red	Too weak   Too strong  
	Green	
	Blue	

 <b>OSD</b>		
Adjustment Item	Problem / Option	Button to Press
 H.Position	OSD is too left OSD is too right	   
 V.Position	OSD is too low OSD is too high	   
 OSD Time	You can set the OSD display duration time between 5 and 30 seconds.	   



















## Language

Adjustment Item	Problem / Option		Button to Press	
Language	English	English	Español	Spanish
	Français	French	Nederlands	Dutch
	Deutsch	German	日本語	Japanese
	Italiano	Italian	简体中文	Simplified Chinese
	Polski	Polish	Русский	Russian



## Recall

Adjustment Item	Problem / Option		Button to Press	
Recall All	Yes	Factory-preset data is restored.		
	No	Return to Menu.		

 <b>Miscellaneous</b>			
Adjustment Item	Problem / Option		Button to Press
 Sharpness	1 2 3 4 5 You can change the picture quality from 1 to 5 (sharp to soft). Press the ► Button to change the picture quality in numerical order. Press the ◀ Button to change the picture quality in reverse numerical order.		   
 DDC/CI	On	DDC/CI is turned ON.	
	Off	DDC/CI is turned OFF.	
<b>NOTE</b> DDC/CI On and Off are switched as follows by pressing the ► Button successively. ⇒ On → Off ⇐			
 Display Information	Displays information regarding the current input signal coming from the graphic card in your computer. <div data-bbox="565 643 918 760" style="border: 1px solid black; padding: 5px; margin: 10px 0;"> <p style="text-align: center; font-size: small;">Miscellaneous</p> <p style="text-align: center;">⊕ Display Information</p> <p style="text-align: center; font-size: x-small;">1920x1080 @ 60 Hz</p> </div>		
<b>NOTE</b> See your graphic card user guide for more information about changing the resolution and refresh.			
 ACR	On	Increased Contrast Ratio	
	Off	Typical Contrast Ratio	
 Display Mode	Full	Expansion display	
	Aspect	Expansion display of Aspect	
 OD	Off / 1 / 2 / 3 It will improve the gray level response time of the LCD panel. A higher level results in a faster response time.		   
 Opening Logo	On	iiyama Logo displayed when the monitor is turned on.	
	Off	iiyama Logo does not display when the monitor is turned on.	

12 Input Select		
Adjustment Item	Problem / Option	Button to Press
12 Input Select	D-sub	Select the Analog input.
	DVI	Select the Digital (DVI) input.
	HDMI	Select the Digital (HDMI) input.
<b>NOTE</b> When only one of the three signal inputs is connected to the signal source, the one connected is automatically selected. Input Select function is not available if there is no signal input from the selected connector or during the power management mode.		

Audio*		
Adjustment Item	Problem / Option	Button to Press
Volume	Too soft	
	Too loud	
Mute	On	Turn off the sound temporarily.
	Off	Return the sound volume to the previous level.
<b>NOTE</b> Mute On and Off are switched as follows by pressing the  Button successively. On → Off		

\* Suitable for HDMI input only.

**Direct**

You can skip the Menu items and display an adjustment scale directly by using the following button operations.

- ECO Mode : Press the Button when the Menu is not displayed.
  - On : Brightness of back light is reduced.
  - Off : Normal
- i-Style Color : Press the EXIT Button when the Menu is not displayed.
  - Standard : For general windows environment and monitor default setting.
  - Game : For PC game environment.
  - Cinema : For movie and video environment.
  - Scenery : For displaying outdoor scenery images.
  - Text : For text editing and viewing in a word processing environment.

## SCREEN ADJUSTMENTS

Adjust the image by following the procedure below to get the desired picture when selecting Analog input.

- The screen adjustments described in this manual are designed to set image position and minimize flicker or blur for the particular computer in use.
- The monitor is designed to provide the best performance at resolution of 1920 × 1080, but can not provide the best at resolutions of less than 1920 × 1080 because the picture is automatically stretched to fit the full screen. It is recommended to operate at resolution of 1920 × 1080 in normal use.
- Displayed text or lines will be blurred or irregular in thickness when the picture is stretched due to the screen enlargement process.
- It is preferable to adjust the image position and frequency with the monitor controls, rather than the computer software or utilities.
- Perform adjustments after a warm-up period of at least thirty minutes.
- Additional adjustments may be required after the Auto Adjust depending on the resolution or signal timing.
- The Auto Adjust may not work correctly when displaying the picture other than the screen adjustment pattern. In this case, manual adjustments are required.

There are two ways to adjust the screen. One way is automatic adjustment for Position, Pixel Clock and Phase. The other way is performing each adjustment manually.

Perform the Auto Adjust first when the monitor is connected to a new computer, or resolution is changed. If the screen has a flicker or blur, or the picture does not fit in the display area after performing the Auto Adjust, manual adjustments are required. Both adjustments should be made by using the screen adjustment pattern (Test.bmp) obtained via the IIYAMA web site (<http://www.iiyama.com>).

Adjust the image by following the procedure below to get the desired picture.

This manual explains adjustment under Windows 95/98/2000/Me/XP/Vista/7.

- ① **Display the picture at the optimum resolution.**
- ② **Enter the Test.bmp (screen adjustment pattern) to wallpaper.**

### NOTE

- Consult the appropriate documentation for doing this.
- Test.bmp is made at resolution of 1280 × 1024. Set the display position to center in the wallpaper setting dialogue box. If you use Microsoft® PLUS! 95/98 cancel the setting of "Stretch desktop wallpaper to fit the screen".

### [Adjustment pattern]

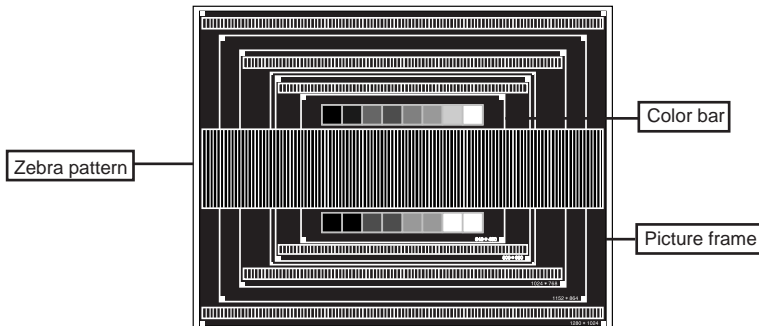

- ③ Press the Auto Button. (Auto Adjust)
- ④ Adjust the image manually by following procedure below when the screen has a flicker or blur, or the picture does not fit in the display area after performing the Auto Adjust.
- ⑤ Adjust the V.Position so that the top and bottom of the picture frame will fit to the display area.

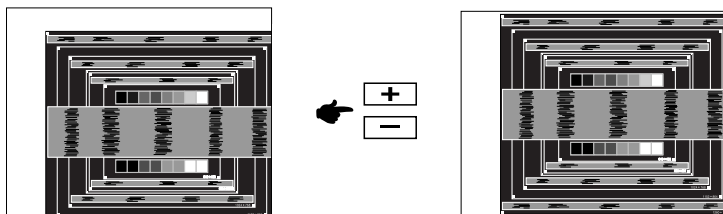

- ⑥ 1) Adjust the H.Position so that the left side of the picture frame will move to the left edge of the display area.

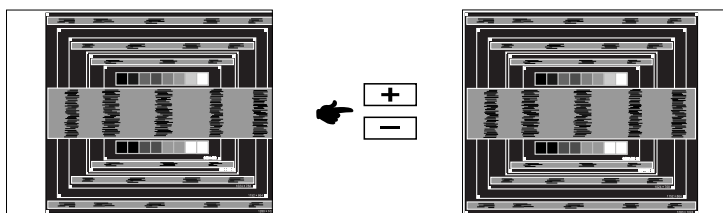

- 2) Stretch the right side of the picture frame to the right edge of the display area by adjusting the Pixel Clock.

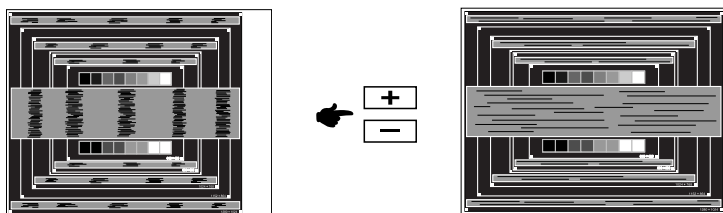
**NOTE**

- When the left side of the picture frame moves apart from the left edge of the display area during the Pixel Clock adjustment, adjust steps 1) and 2).
- Another way to make the Pixel Clock adjustment is to correct the vertical wavy lines in the zebra pattern.
- The picture may flicker during the Pixel Clock, H.Position and V.Position adjustment.
- In case the picture frame is bigger or smaller than the data display area after the Pixel Clock adjustment, repeat steps from ③.

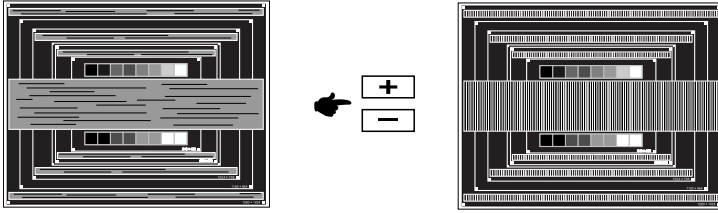

- ⑦ Adjust the Phase to correct horizontal wavy noise, flicker or blur in the zebra pattern.

**NOTE**

- In case the strong flicker or blurs remain on a part of the screen, repeat steps ⑥ and ⑦ because the Pixel Clock may not be adjusted correctly.
- Adjust the H.Position after the Phase adjustment if the horizontal position moves during the adjustment.

- ⑧ Adjust the Brightness and Color to get the desired picture after you complete the Pixel Clock and Phase adjustments.

Put back your favorite wallpaper.

## POWER MANAGEMENT FEATURE

The power management feature of this product complies with power saving requirement of ENERGY STAR® and VESA DPMS. When activated, it automatically reduces unnecessary power consumption of the monitor when your computer is not in use.

To use the feature, the monitor needs to be connected to a VESA DPMS compliant computer. There is a power management step the monitor takes as described below. The power management function, including any timer settings is configured by the operating system. Check your operating system manual for information on how this can be configured.

### ■ Power Management Mode

When the H-sync signal / V-sync signal / H and V sync signals from the computer are off, the monitor enters into Power Management Mode which reduces the power consumption to less than 1W. The screen becomes dark, and the power indicator turns to orange. From Power Management Mode, the image reappears in several seconds when either the keyboard or the mouse are touched again.

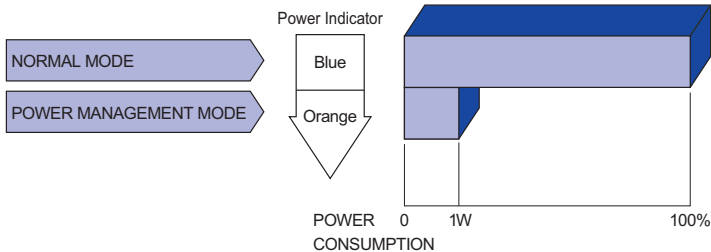

### NOTE

- Even when using the power management mode, the monitor consumes electricity. Turn off the Power Switch whenever the monitor is not in use, during the night and weekends, to avoid unnecessary power consumption.
- It is possible that the video signal from the computer may be on while the H or V sync signal is missing. In this instance, the POWER MANAGEMENT feature may not work properly.

## TROUBLE SHOOTING

If the monitor fails to operate correctly, please follow the steps below for a possible solution.

1. Perform the adjustments described in OPERATING THE MONITOR, depending on the problem you have. If the monitor does not get a picture, skip to 2.
2. Consult the following items if you cannot find an appropriate adjustment item in OPERATING THE MONITOR or if the problem persists.
3. If you are experiencing a problem which is not described below or you cannot correct the problem, discontinue using the monitor and contact your dealer or iiyama service center for further assistance.

<b>Problem</b>	<b>Check</b>
<p>① The picture does not appear.</p> <p>(Power indicator does not light up.)</p> <p>(Power indicator is blue.)</p> <p>(Power indicator is orange.)</p>	<ul style="list-style-type: none"> <li><input type="checkbox"/> The AC Adapter is firmly seated in the connector.</li> <li><input type="checkbox"/> The Power Cable is firmly seated in the socket of the AC Adapter.</li> <li><input type="checkbox"/> The Power Cable is firmly seated in the socket.</li> <li><input type="checkbox"/> The Power Switch is turned ON.</li> <li><input type="checkbox"/> The AC socket is live. Please check with another piece of equipment.</li> <li><input type="checkbox"/> If the blank screen saver is in active mode, touch the keyboard or the mouse.</li> <li><input type="checkbox"/> Increase the Contrast and/or Brightness.</li> <li><input type="checkbox"/> The computer is ON.</li> <li><input type="checkbox"/> The Signal Cable is properly connected.</li> <li><input type="checkbox"/> The signal timing of the computer is within the specification of the monitor.</li> <li><input type="checkbox"/> If the monitor is in power management mode, touch the keyboard or the mouse.</li> <li><input type="checkbox"/> The computer is ON.</li> <li><input type="checkbox"/> The Signal Cable is properly connected.</li> <li><input type="checkbox"/> The signal timing of the computer is within the specification of the monitor.</li> </ul>
<p>② The screen is not synchronized.</p>	<ul style="list-style-type: none"> <li><input type="checkbox"/> The Signal Cable is properly connected.</li> <li><input type="checkbox"/> The signal timing of the computer is within the specification of the monitor.</li> <li><input type="checkbox"/> The video output level of the computer is within the specification of the monitor.</li> </ul>
<p>③ The screen position is not in the center.</p>	<ul style="list-style-type: none"> <li><input type="checkbox"/> The signal timing of the computer is within the specification of the monitor.</li> </ul>
<p>④ The screen is too bright or too dark.</p>	<ul style="list-style-type: none"> <li><input type="checkbox"/> The video output level of the computer is within the specification of the monitor.</li> </ul>

## Problem

## Check

- |                                 |  |
|---------------------------------|--|
| <p>⑤ The screen is shaking.</p> | <p><input type="checkbox"/>The power voltage is within the specification of the monitor.<br/><input type="checkbox"/>The signal timing of the computer is within the specification of the monitor.</p> |
| <p>⑥ No sound.</p>              | <p><input type="checkbox"/>The Volume is turned up.<br/><input type="checkbox"/>The Mute is OFF.</p>   |

## RECYCLING INFORMATION

For better environment protection please don't dispose your monitor.  
Please visit our web site: [www.iiyama.com/recycle](http://www.iiyama.com/recycle) for monitor recycling.

# APPENDIX

## SPECIFICATIONS : ProLite XB2472HD

ENGLISH

Size Category		24"
LCD Panel	Driving system	a-Si TFT Active Matrix
	Size	Diagonal: 24" (61cm)
	Pixel pitch	0.277mm H x 0.277mm V
	Brightness	250cd/m <sup>2</sup> (Typical)
	Contrast ratio	3000 : 1 (Typical), ACR Function Available
	Viewable angle	Right / Left : 89 degrees each, Up / Down : 89 degrees each (Typical)
	Response time	25ms (Typical), 8ms (Gray to Gray)
Display Colors		16,777,216
Sync Frequency		Horizontal: 30.0-75.0kHz, Vertical: 55-70Hz
Maximum Resolution		1920 x 1080, 2.1 MegaPixels
Input Connector		D-Sub mini 15 pin, DVI-D 24 pin, HDMI
Plug & Play		VESA DDC2B™
Input Sync Signal		Separate sync: TTL, Positive or Negative
Input Video Signal		Analog: 0.7Vp-p (Standard), 75Ω, Positive Digital: DVI (Digital Visual Interface Standard Rev.1.0) compliance Digital: HDMI (Ver.1.3)
Output Audio Connector		ø 3.5mm mini jack (Stereo)
Maximum Screen Size		531.36mm W x 298.89mm H / 20.9" W x 11.8" H
Power Source		DC19V, 2.63A
AC Adapter (accessory)		Input: 100-240VAC, 50/60Hz
Power Consumption		34W typical, Power management mode: 1W maximum
Dimensions / Net Weight		570.0 x 438.0 - 568.0 x 214.5mm / 22.4 x 17.2 - 22.4 x 8.4" (WxHxD) 6.2kg / 13.67lbs (Excluding the AC Adapter)
Tilt Angle		Upward: 20 degrees Downward: 5 degrees Left/Right: 45 degrees each
Environmental Considerations		Operating: Temperature 5 to 35°C / 41 to 95°F Humidity 10 to 80% (No condensation) Storage: Temperature -20 to 60°C / -4 to 140°F Humidity 5 to 85% (No condensation)
Approvals		CE, TÜV-Bauart, VCCI-B, Energy Star

## SPECIFICATIONS : ProLiteX2472HD

Size Category	24"	
LCD Panel	Driving system	a-Si TFT Active Matrix
	Size	Diagonal: 24" (61cm)
	Pixel pitch	0.277mm H x 0.277mm V
	Brightness	250cd/m <sup>2</sup> (Typical)
	Contrast ratio	3000 : 1 (Typical), ACR Function Available
	Viewable angle	Right / Left : 89 degrees each, Up / Down : 89 degrees each (Typical)
	Response time	25ms (Typical), 8ms (Gray to Gray)
Display Colors	16,777,216	
Sync Frequency	Horizontal: 30.0-75.0kHz, Vertical: 55-70Hz	
Maximum Resolution	1920 x 1080, 2.1 MegaPixels	
Input Connector	D-Sub mini 15 pin, DVI-D 24 pin, HDMI	
Plug & Play	VESA DDC2B™	
Input Sync Signal	Separate sync: TTL, Positive or Negative	
Input Video Signal	Analog: 0.7Vp-p (Standard), 75Ω, Positive Digital: DVI (Digital Visual Interface Standard Rev.1.0) compliance Digital: HDMI (Ver.1.3)	
Output Audio Connector	ø 3.5mm mini jack (Stereo)	
Maximum Screen Size	531.36mm W x 298.89mm H / 20.9" W x 11.8" H	
Power Source	DC19V, 2.63A	
AC Adapter (accessory)	Input: 100-240VAC, 50/60Hz	
Power Consumption	34W typical, Power management mode: 1W maximum	
Dimensions / Net Weight	570.0 x 420.0 x 179.0mm / 22.4 x 16.5 x 7.0" (WxHxD) 3.8kg / 8.37lbs (Excluding the AC Adapter)	
Tilt Angle	Upward: 15 degrees Downward: 5 degrees	
Environmental Considerations	Operating: Temperature 5 to 35°C / 41 to 95°F Humidity 10 to 80% (No condensation) Storage: Temperature -20 to 60°C / -4 to 140°F Humidity 5 to 85% (No condensation)	
Approvals	CE, TÜV-Bauart, VCCI-B, Energy Star	

**DIMENSIONS : ProLite XB2472HD**

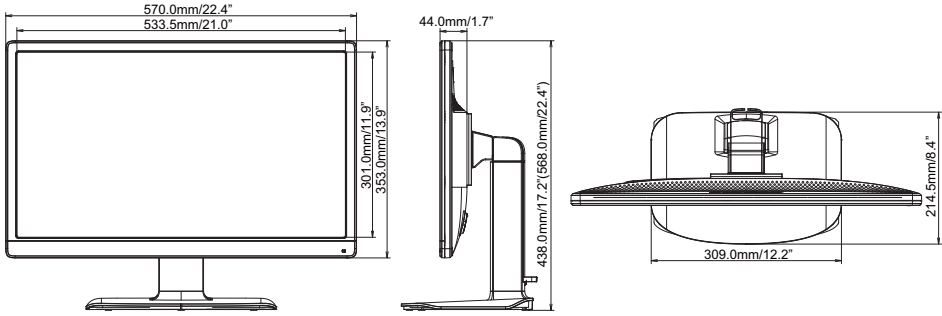

( ) : Maximum adjustment range

**DIMENSIONS : ProLite X2472HD**

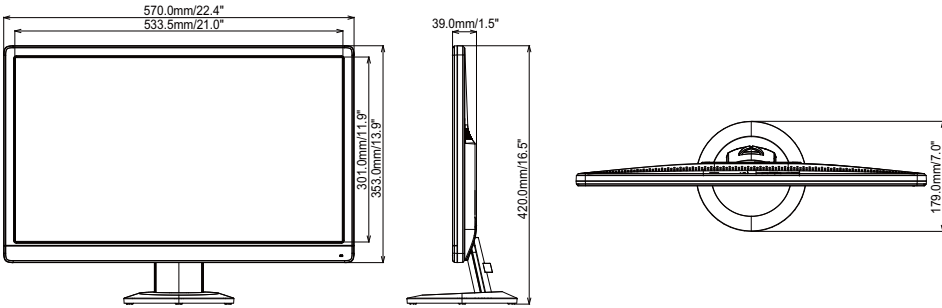

**COMPLIANT TIMING**

**PC Input**

Video Mode		Horizontal Frequency	Vertical Frequency	Dot Clock
VESA	VGA 640x480	31.469kHz	59.940Hz	25.175MHz
	SVGA 800x600	37.879kHz	60.317Hz	40.000MHz
	XGA 1024x768	48.363kHz	60.004Hz	65.000MHz
	SXGA 1280x1024	63.981kHz	60.020Hz	108.000MHz
	WXGA+ 1440x900	55.935kHz	59.887Hz	106.500MHz
	UXGA 1600x1200	75.000kHz	60.000Hz	162.000MHz
	WSXGA+ 1680x1050	65.290kHz	60.000Hz	146.250MHz
	Full HD 1920x1080	66.590kHz	59.930Hz	138.500MHz
VGA TEXT	640x350	31.469kHz	70.087Hz	25.175MHz *
	720x400	31.469kHz	70.087Hz	28.322MHz *

**NOTE** \* DVI input is not compliant.