



# LED Powerbrick Set v2

ORDERCODE 41322



**SHOWELECTRONICS FOR PROFESSIONALS**

## **Congratulations!**

You have bought a great, innovative product from Showtec.

The Showtec LED Powerbrick Set brings excitement to any venue. Whether you want simple plug-&-play action or a sophisticated DMX show, this product provides the effect you need.

You can rely on Showtec, for more excellent lighting products.

We design and manufacture professional light equipment for the entertainment industry.

New products are being launched regularly. We work hard to keep you, our customer, satisfied.

For more information: [iwant@showtec.info](mailto:iwant@showtec.info)

You can get some of the best quality, best priced products on the market from Showtec.

So next time, turn to Showtec for more great lighting equipment.

Always get the best -- with Showtec !

Thank you!



**Showtec LED Powerbrick Set™ Product Guide**

**Warning**..... 2  
    Safety-instructions..... 2  
    Operating Determinations..... 3

**Description**..... 4  
    Features and Overview ..... 4  
    Backside..... 4

**Installation**..... 5

**Set Up and Operation**..... 5  
    **1) Connected separate**..... 5  
    **2) Connected on top of each other by using the supplied brackets**..... 5  
    **3) Connected Side by Side**..... 5  
    Functions..... 7  
        Stand-alone ..... 7  
        Connection Stand-alone..... 10  
        DMX Controlled ..... 10  
        Connection DMX ..... 14

**Illuminance Distribution**..... 15  
    Candle Power distribution..... 16

**Maintenance**..... 17  
    Changing the Fuse..... 17

**Troubleshooting**..... 17

**Product Specifications**..... 18

## WARNING



**FOR YOUR OWN SAFETY, PLEASE READ THIS USER MANUAL CAREFULLY  
BEFORE YOUR INITIAL START-UP!**

## SAFETY INSTRUCTIONS

Every person involved with the installation, operation and maintenance of this device has to:

- be qualified
- follow the instructions of this manual

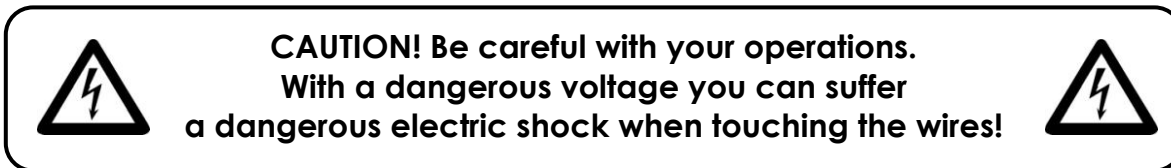

Before your initial start-up, please make sure that there is no damage caused by transportation. Should there be any, consult your dealer and do not use the device.

To maintain perfect condition and to ensure a safe operation, it is absolutely necessary for the user to follow the safety instructions and warning notes written in this manual.

Please consider that damages caused by manual modifications to the device are not subject to warranty.

This device contains no user-serviceable parts. Refer servicing to qualified technicians only.

## IMPORTANT:

*The manufacturer will not accept liability for any resulting damages caused by the non-observance of this manual or any unauthorized modification to the device.*

- Never let the power-cord come into contact with other cables! Handle the power-cord and all connections with the mains with particular caution!
- Never remove warning or informative labels from the unit.
- Never leave any cables lying around.
- Do not insert objects into air vents.
- Do not open the device and do not modify the device.
- Do not connect this device to a dimmerpack.
- Do not shake the device. Avoid brute force when installing or operating the device.
- Do not switch the device on and off in short intervals, as this would reduce the system's life.
- Only use device indoor, avoid contact with water or other liquids.
- Only operate the fixture after having checked that the housing is firmly closed and all screws are tightly fastened.
- Only operate the device after having familiarized with its functions.
- Avoid flames and do not put close to flammable liquids or gases.
- Always keep case closed while operating.
- Always allow free air space of at least 50 cm around the unit for ventilation.
- Always disconnect power from the mains, when device is not used or before cleaning! Only handle the power-cord by the plug. Never pull out the plug by tugging the power-cord.

- Make sure that the device is not exposed to extreme heat, moisture or dust.
- Make sure that the available voltage is not higher than stated on the rear panel.
- Make sure that the power-cord is never crimped or damaged. Check the device and the power-cord from time to time.
- If device is dropped or struck, disconnect mains power supply immediately. Have a qualified engineer inspect for safety before operating.
- If the device has been exposed to drastic temperature fluctuation (e.g. after transportation), do not switch it on immediately. The arising condensation water might damage your device. Leave the device switched off until it has reached room temperature.
- If your Showtec device fails to work properly, discontinue use immediately. Pack the unit securely (preferably in the original packing material), and return it to your Showtec dealer for service.
- The user is responsible for correct positioning and operating of the LED Powerbrick. The manufacturer will not accept liability for damages caused by the misuse or incorrect installation of this device.
- For adult use only. The device must be installed out of the reach of children. Never leave the unit running unattended.
- For replacement use fuses of same type and rating only.
- Repairs, servicing and electric connection must be carried out by a qualified technician.
- WARRANTY: Till one year after date of purchase.

## OPERATING DETERMINATIONS

If this device is operated in any other way, than the one described in this manual, the product may suffer damages and the warranty becomes void.

Any other operation may lead to dangers like short-circuit, burns, electric shock, lamp explosion, crash etc.

You endanger your own safety and the safety of others!

### Rigging

*Please follow the European and national guidelines concerning rigging, trussing and all other safety issues.*

*Do not attempt the installation yourself !*

*Always let the installation be carried out by an authorized dealer !*

### Procedure:

- If the projector is lowered from the ceiling or high joists, professional trussing systems have to be used.
- Use a clamp to mount the projector, with the mounting-bracket, to the trussing system.
- The projector must never be fixed swinging freely in the room.
- The installation must always be secured with a safety attachment, e.g. an appropriate safety net or safety-cable.
- When rigging, derigging or servicing the projector, always make sure, that the area below the installation place is blocked and staying in the area is forbidden.

*Improper installation can cause serious damage to people and property !*

# Description of the device

## Features

The LED Powerbrick Set is a LED system from Showtec.

- Powerbrick set contains 4 Powerbricks, one controller, power leads, DMX leads.
- Ultra bright LED
- First grade aluminum body construction
- Unlimited colors
- Low power consumption
- Low heat design, great for long time operation.
- Lifetime: 100.000 hours

NOTE: Knowledge of DMX is required to fully utilize this unit.

## Overview



Fig. 1

## Backside



Fig. 2



Fig. 3

- 1) 3-pin DMX signal connector (OUT)
- 2) 3-pin DMX signal connector (IN)
- 3) 5-pin DMX signal connector (OUT)
- 4) 5-pin DMX signal connector (IN)
- 5) IEC Connector + Fuse

- 6) LCD Display
- 7) EXIT
- 8) SET
- 9) UP
- 10) DOWN

## Installation

Remove all packing materials from the LED Powerbrick Set. Check that all foam and plastic padding is removed. Connect all cables.

**Always disconnect from electric mains power supply before cleaning or servicing.**

**Damages caused by non-observance are not subject to warranty.**

## Set Up and Operation

Before plugging the unit in, always make sure that the power supply matches the product specification voltage. Do not attempt to operate a 120V specification product on 230V power, or vice versa.

**Note : Link all cables before connecting electric power.**

You have 3 possibilities to set up your LED Powerbrick Set:

### 1) Separate



### 2) Connected on top of each other by using the supplied brackets



Bracket



Mounting the separate Powerbricks



Backside connection

### 3) Connected Side by Side

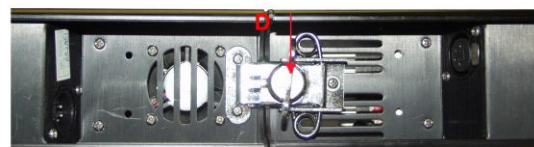
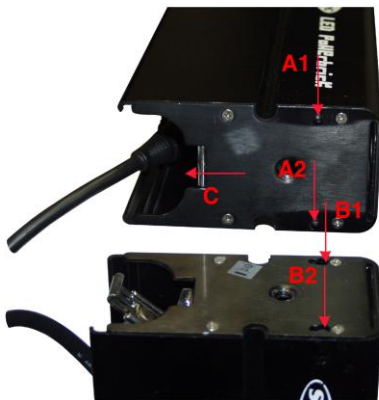

Be sure to put the devices next to each other and slide Pin **A1** in hole **B1**, do the same for pin **A2** in hole **B2**. Then slide the first device in the direction of **C**. The last step is securing the devices at the back by using clasp **D** and turning it clockwise to tighten the locking mechanism.



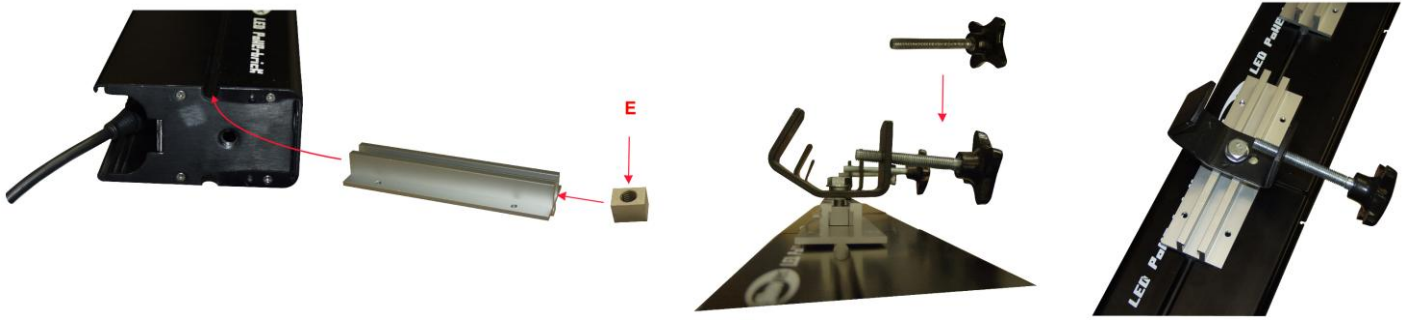

Be sure to put the small cube **E** and the aluminum section together in the small slot.

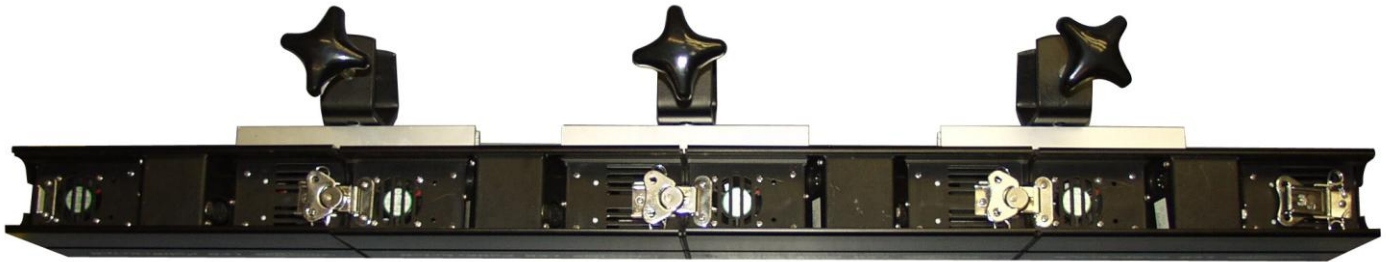

Backside connection of 4 LED Powerbricks

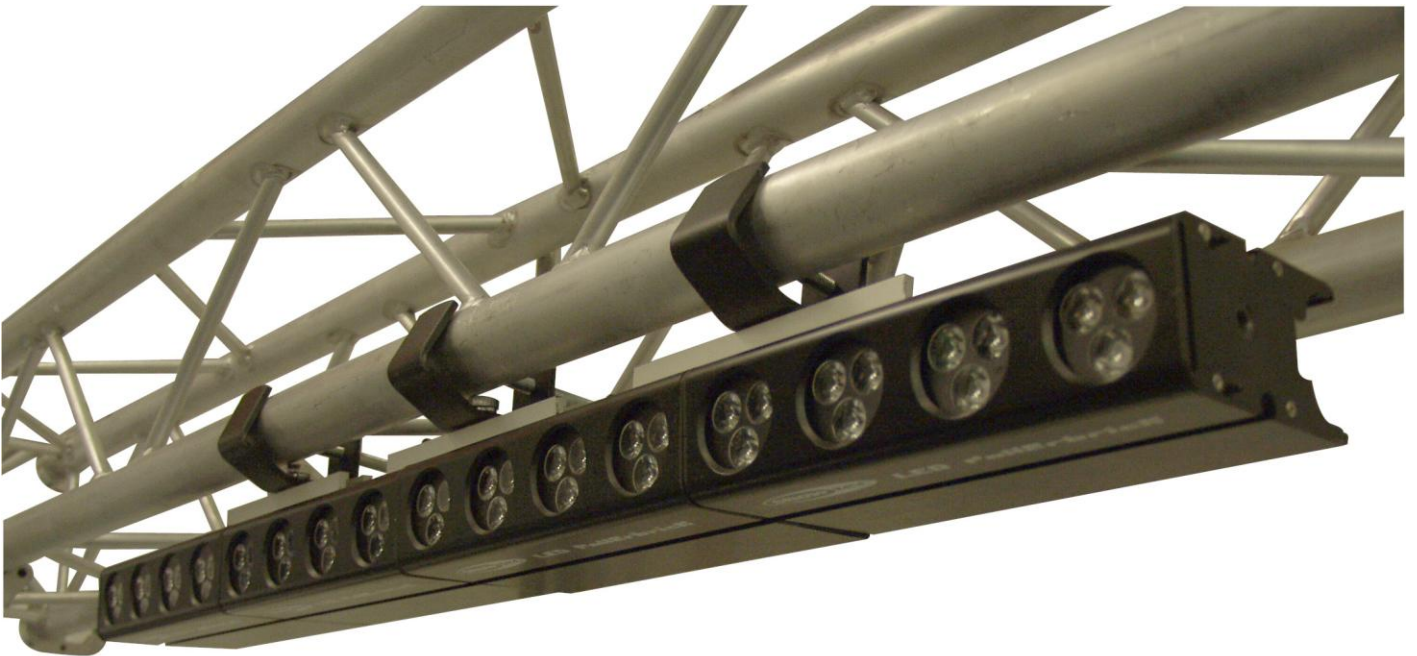

Connecting the entire LED Powerbrick system to a Truss system.



## **FUNCTIONS:**

There are 3 options to operate the LED Powerbrick: Stand-alone  
Master / Slave  
DMX Mode

After completing your settings, be sure to unplug the Powerbricks and the controller, otherwise errors could occur.

This way you reset the entire system, but your settings keep stored in the memory of the controller.

## **Stand-alone**

1. The device will start test-mode.
2. Press the Up/Down button until the display shows: **17. System Mode**.
3. Press the Set button to enter the menu.
4. Enter the amount of tubes you are using.
5. For **Stand-alone** you have to use **DMX Channel: 0**, then press the Set Up-button again.
6. The LCD now shows "Set Address YES"; press SETUP-Button (=NO) to keep your previous settings, or YES (=Up-Button) to store your choice. The LED Tubes will light up.
7. Now your unit is a stand-alone. You will find all the pre-programmed scenes below.

### **Menu**

1. Static RED	Function Set
2. Static GREEN	Function Set
3. Static YELLOW	Function Set
4. Static BLUE	Function Set
5. Static PURPLE	Function Set
6. Static CYAN	Function Set
7. Static WHITE	Function Set
8. Color Change	Function Set
9. Flow 1 (FF)	Function Set
10. Flow 2 (REW)	Function Set
11. Flow 3 (FF/REW)	Function Set
12. 2 Color Chase	Function Set
13. Multi-Color Chase	Function Set
14. Fade Change	Function Set
15. 2 Color Fade Chase	Function Set
16. Auto Run	Function Set
17. System Mode	Function Set

When "Function Set" appears in the LCD, then you are able to make some extra settings: Dimmer, Run Speed, Flash Freq, etc.

1. Static RED	<b>1) Red</b> Set < >	Function Set : Gray Level 0-100 (1X Set Up) Flash Freq 0-100 (2X Set Up) Exit : Return to the Mode Menu
2. Static GREEN	<b>2) Green</b> Set < >	Function Set : Gray Level 0-100 (1X Set Up) Flash Freq 0-100 (2X Set Up) Exit : Return to the Mode Menu
3. Static YELLOW	<b>3) Yellow</b> Set < >	Function Set : Gray Level 0-100 (1X Set Up) Flash Freq 0-100 (2X Set Up) Exit : Return to the Mode Menu
4. Static BLUE	<b>4) Blue</b> Set < >	Function Set : Gray Level 0-100 (1X Set Up) Flash Freq 0-100 (2X Set Up) Exit : Return to the Mode Menu
5. Static PURPLE	<b>5) Purple</b> Set < >	Function Set : Gray Level 0-100 (1X Set Up) Flash Freq 0-100 (2X Set Up) Exit : Return to the Mode Menu
6. Static CYAN	<b>6) Cyan</b> Set < >	Function Set : Gray Level 0-100 (1X Set Up)) Flash Freq 0-100 (2X Set Up) Exit : Return to the Mode Menu
7. Static WHITE	<b>7) White</b> Set < >	Function Set : Gray Level 0-100 (1X Set Up) Flash Freq 0-100 (2X Set Up) Exit : Return to the Mode Menu
8. Color Change	<b>8) Color Change</b> Set < >	Function Set : Run Speed 0-100 (1X Set Up) Flash Freq 0-100 (2X Set Up) Color Sort 0-20 (3X Set Up) Run Times 0-20 (4X Set Up) Exit : Return to the Mode Menu
9. Flow 1 (FF)	<b>9) Flow 1 (FF)</b> Set < >	Function Set : Run Speed 0-100 (1X Set Up) Flash Freq 0-100 (2X Set Up) Color Sort 0-20 (3X Set Up) Run Times 0-20 (4X Set Up) Exit : Return to the Mode Menu
10. Flow 2 (REW)	<b>10) Flow 2 (REW)</b> Set < >	Function Set : Run Speed 0-100 (1X Set Up) Flash Freq 0-100 (2X Set Up) Color Sort 0-20 (3X Set Up) Run Times 0-20 (4X Set Up) Exit : Return to the Mode Menu

11. Flow 3 (FF/REW)	<b>11) Flow 3 (FF/REW)</b> Set < >	Function Set : Run Speed 0-100 (1X Set Up) Flash Freq 0-100 (2X Set Up) Color Sort 0-20 (3X Set Up) Run Times 0-20 (4X Set Up) Exit : Return to the Mode Menu
12. 2 Color Chase	<b>12) 2. Color chase</b> Set < >	Function Set : Run Speed 0-100 (1X Set Up) Flash Freq 0-100 (2X Set Up) Color Sort 0-20 (3X Set Up) Run Times 0-20 (4X Set Up) Exit : Return to the Mode Menu
13. Multi-Color Chase	<b>13) M. Color chase</b> Set < >	Function Set : Run Speed 0-100 (1X Set Up) Flash Freq 0-100 (2X Set Up) Color Sort 0-20 (3X Set Up) Run Times 0-20 (4X Set Up) Exit : Return to the Mode Menu
14. Fade Change	<b>14) Fade change</b> Set < >	Function Set : Run Speed 0-100 (1X Set Up) Flash Freq 0-100 (2X Set Up) Color Sort 0-20 (3X Set Up) Run Times 0-20 (4X Set Up) Exit : Return to the Mode Menu
15. 2 Color Fade Chase	<b>15) 2. Color Fade chase</b> Set < >	Function Set : Run Speed 0-100 (1X Set Up) Flash Freq 0-100 (2X Set Up) Color Sort 0-20 (3X Set Up) Run Times 0-20 (4X Set Up) Exit : Return to the Mode Menu
16. Auto Run	<b>16) Auto run</b>	
17. System Mode	<b>17) System mode</b> Set < >	Function Set : Channels / Pixel (1X Set Up) DMX START Channel 0-510 (2X Set Up) Master / Slave (3X Set Up) Pixels / Tube (4X Set Up) Tubes Qty (5X Set Up) Exit : Return to the Mode Menu

In menu 8 - 15 you are also able to change the color of the chase or flow.  
There are 20 available color varieties.

Channels / Pixel: you can choose 3, 4 or 5 channels per pixel

Pixels / Tube: you can choose different the sections (1/5 – 4)

- 1/5 means all the 4 LED Powerbricks are as one
- 1 means one LED Powerbrick is 1 section
- 2 means each LED Powerbrick has 2 sections
- 4 means each LED Powerbrick has 4 sections

Tubes Qty: Choose the number of the LED Powerbricks to be controlled.

## Connection Stand-alone

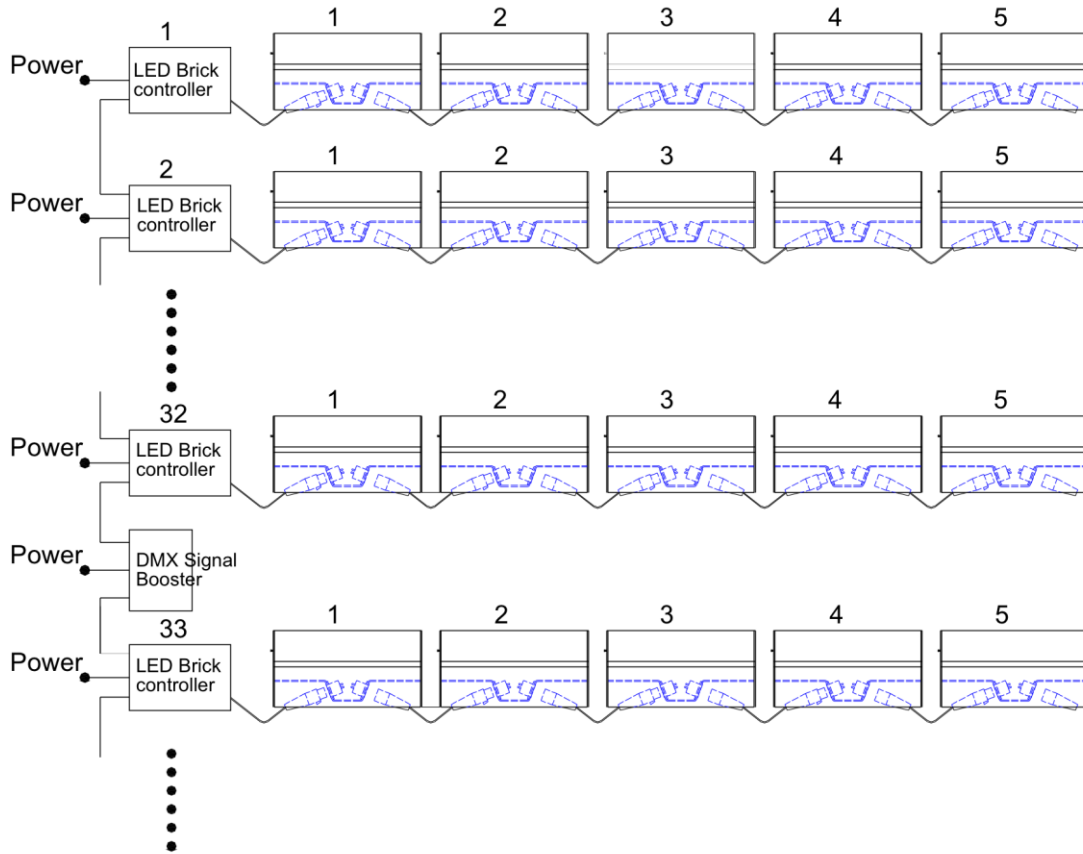

## DMX Controlled

1. The device will start test-mode.
2. Press the Up/Down button until the display shows: **17. System Mode**.
3. Press the Set button to enter the menu.
4. Enter the amount of tubes you are using.
5. For **DMX Controlled** you have to use **DMX Channel: 1-510**, then press the Set Up-button again.
6. The LCD now shows "Set Address YES"; press SETUP-Button (=NO) to keep your previous settings, or YES (=Up-Button) to store your choice.
7. Now your unit is DMX-Controlled. You will find all the pre-programmed scenes below.

There are 12 possibilities for working in DMX mode; See page 11 – 14 for all Modes

**Option 1**

CH/Pixel: 3

Pixels/Tube: 1/5

Total Channels: 3

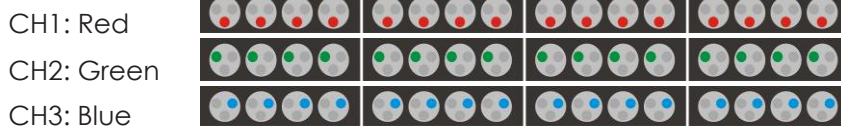

**Option 2**

CH/Pixel: 3

Pixels/Tube: 1

Total Channels: 12

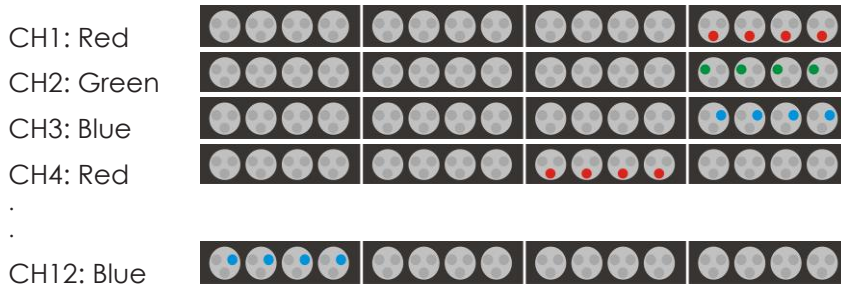

**Option 3**

CH/Pixel: 3

Pixels/Tube: 2

Total Channels: 24

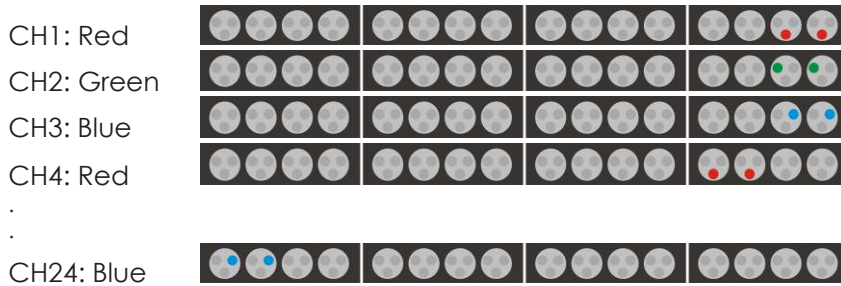

**Option 4**

CH/Pixel: 3

Pixels/Tube: 4

Total Channels: 48

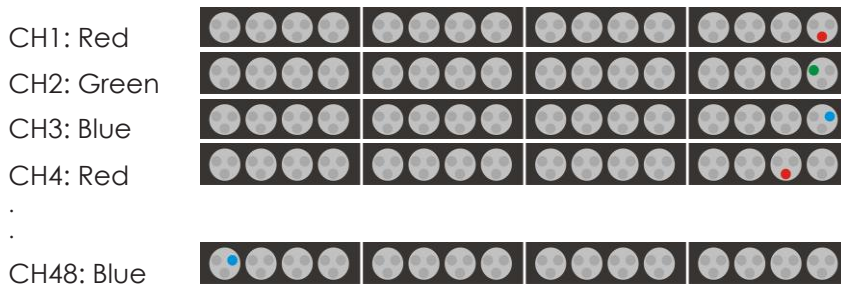

### Option 5

CH/Pixel: 4                      Pixels/Tube: 1/5

Total Channels: 4

CH1: Master Dimmer

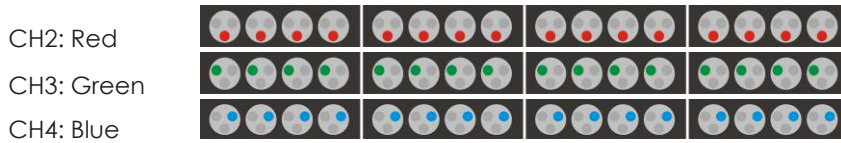

### Option 6

CH/Pixel: 4                      Pixels/Tube: 1

Total Channels: 16

CH1: Master Dimmer 1<sup>st</sup> Powerbrick

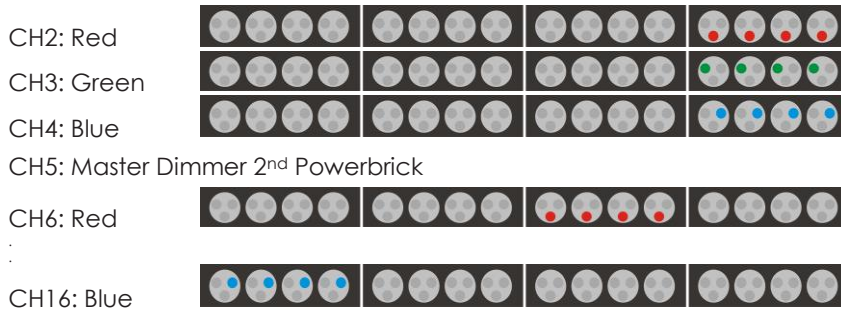

### Option 7

CH/Pixel: 4                      Pixels/Tube: 2

Total Channels: 32

CH1: Master Dimmer 1<sup>st</sup> Powerbrick (LED 1+2)

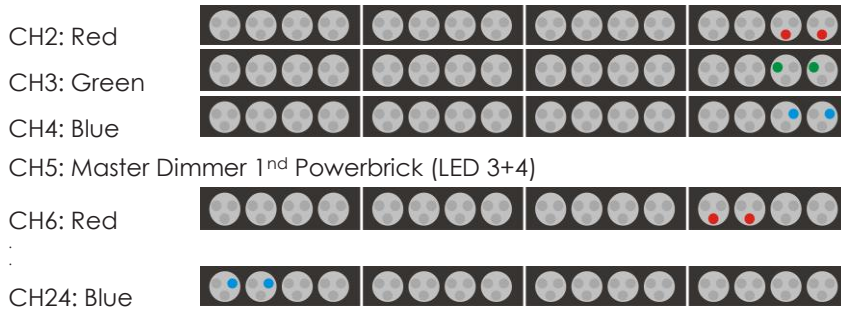

### Option 8

CH/Pixel: 4                      Pixels/Tube: 4

Total Channels: 64

CH1: Master Dimmer 1<sup>st</sup> Powerbrick (LED1)

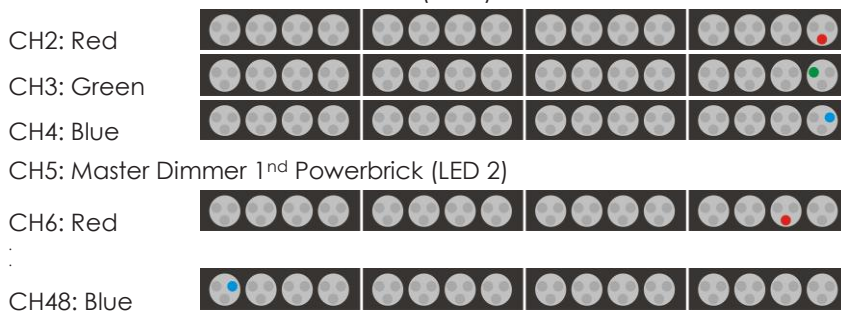



**Option 9**

CH/Pixel: 5

Pixels/Tube: 1/5

Total Channels: 5

CH1: Master Dimmer

CH2: Strobe

CH3: Red



CH4: Green



CH5: Blue



**Option 10**

CH/Pixel: 5

Pixels/Tube: 1

Total Channels: 20

CH1: Master Dimmer 1<sup>st</sup> Powerbrick

CH2: Strobe

CH3: Red



CH4: Green



CH5: Blue



CH6: Master Dimmer 2<sup>nd</sup> Powerbrick

CH7: Strobe

CH8: Red



.

CH20: Blue



**Option 11**

CH/Pixel: 5

Pixels/Tube: 2

Total Channels: 40

CH1: Master Dimmer 1<sup>st</sup> Powerbrick (LED 1+2)

CH2: Strobe

CH3: Red



CH4: Green



CH5: Blue



CH6: Master Dimmer 1<sup>nd</sup> Powerbrick (LED 3+4)

CH7: Strobe

CH8: Red



.

CH40: Blue



## Option 12

CH/Pixel: 5

Pixels/Tube: 4

Total Channels: 80

CH1: Master Dimmer 1<sup>st</sup> Powerbrick (LED 1)

CH2: Strobe

CH3: Red



CH4: Green



CH5: Blue

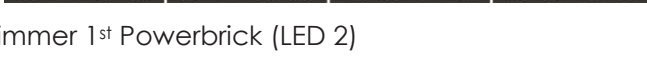

CH6: Master Dimmer 1<sup>st</sup> Powerbrick (LED 2)

CH7: Strobe

CH8: Red



.

CH80: Blue



## Connection DMX

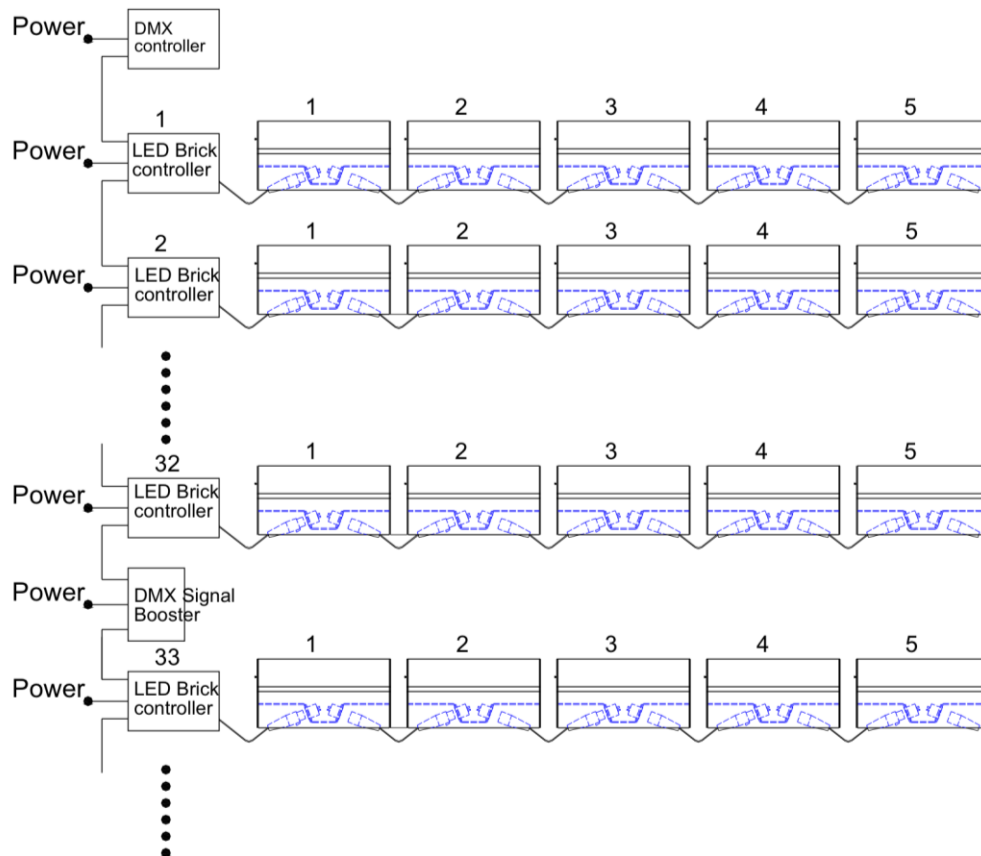

You can control the LED Powerbrick with 3, 4 or 5 channels:

- 3 channel: rRed, Green, Blue.
- 4 channel: Master dimmer, Red, Green, Blue.
- 5 channel: Master dimmer, strobe, Red, Green, Blue.

**Illuminance Distribution**

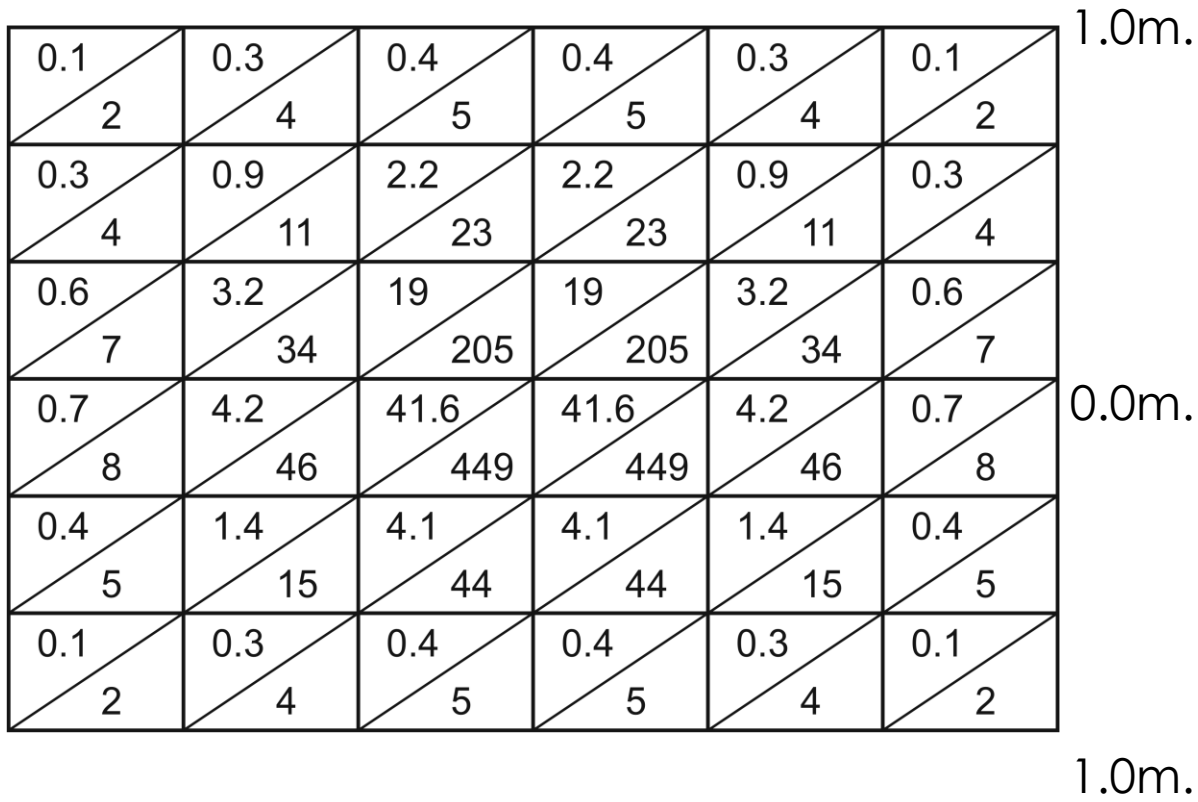

**Illuminance**

COLOR	1	2	3	4	5
WHITE	111 1188.3	27.2 297	12.3 132	6.9 74.2	4.5 47.5
RED	44.3 474.2	11 118.5	4.9 52.6	2.8 29.6	1.8 18.9
GREEN	55.9 599.1	13.9 149.7	6.2 66.5	3.5 37.4	2.2 23.9
BLUE	10.6 113.8	2.6 28.5	1.2 12.6	0.7 7.1	0.4 4.5

# CANDLE POWER DISTRIBUTION

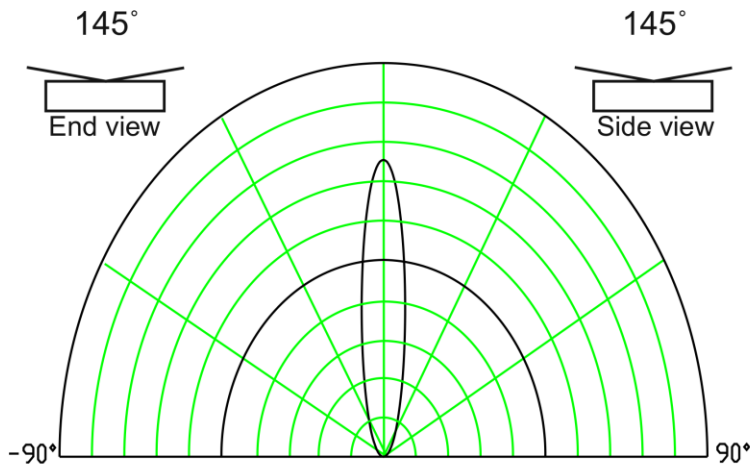

# LIGHT OUTPUT

End view and side view (Candelas)  
 Measured on: White  
 Beam center: 1503.21cd  
 Thin dashed lined: indicates 50% of peak  
 Multipliers: 0.33 Red, 0.33 Green, 0.33 Blue

## LIGHT OUTPUT

COLOR	TOTAL OUTPUT (LUMEN)	POWER (WATT)	EFFICIENCY (lm/W)
WHITE	276.2	38.1	7.2
RED	77.2	25.5	3.0
GREEN	158.3	23.7	6.7
BLUE	47.2	24.3	1.9

Note: The "POWER" in the label is effective power.

## Maintenance

The LED Powerbrick Set requires almost no maintenance. However, you should keep the unit clean. Disconnect the mains power supply, and then wipe the cover with a damp cloth. Do not immerse in liquid. Keep connections clean. Disconnect electric power, and then wipe the connections with a damp cloth. Make sure connections are thoroughly dry before linking equipment or supplying electric power.

### Replacing a Fuse

Power surges, short-circuit or inappropriate electrical power supply may cause a fuse to burn out. If the fuse burns out, the product will not function whatsoever. If this happens, follow the directions below to do so.

1. Unplug the unit from electric power source.
2. Insert a flat-head screwdriver into a slot in the fuse cover. Gently pry up the fuse cover. The fuse will come out.
3. Remove the broken fuse. If brown or unclear, it is burned out.
4. Insert the replacement fuse into the holder where the old fuse was. Reinsert the fuse cover.  
Be sure to use a fuse of the same type and specification. See the product specification label for details.

## Troubleshooting

### Showtec LED Powerbrick Set

This troubleshooting guide is meant to help solve simple problems.

If a problem occurs, carry out the steps below in sequence until a solution is found. Once the unit operates properly, do not carry out following steps.

If the light effect does not operate properly, refer servicing to a technician.

1. If the device does not operate properly, unplug the device.
2. Check the fuse, power from the wall, all cables etc.
3. If all of the above appears to be O.K., plug the unit in again.
4. If you are unable to determine the cause of the problem, do not open the LED Powerbrick Set, as this may damage the unit and the warranty will become void.
5. Return the device to your Showtec dealer.

## Product Specification

Model: Showtec LED Powerbrick Set

### 4 x Powerbrick

Working Voltage: 48V DC

Max. Power: 18W

Colors: 16.7million

Light Source: 1W RGB LED

12 LEDs (4 Red, 4 Green, 4 Blue)

Beam Angle: 25°

Housing: Aluminum body in black

Data connector: 4-pin XLR

Weight: 1,5 kg



### 1 x Powerbrick controller

Voltage: AC 230V-50Hz (CE)

Output 48V DC

Housing: Aluminum body in black

Data connector: 4-pin XLR

Weight: 3.2 Kg



Max. ambient temperature  $t_a$ : 40° C

### Minimum distance:

Minimum distance from flammable surfaces: 0.5m

Minimum distance to lighted object: 1m

Design and product specifications are subject to change without prior notice.



Website: [www.Highlite.nl](http://www.Highlite.nl)

Email: [service@highlite.nl](mailto:service@highlite.nl)







© 2007 Showtec.