



## Pocket Guide

VLT® Soft Starter – the single speed drive

# Contents

## Soft Starter Selection Guide

Warnings .....	5
Common Applications .....	6
MCD Soft Starter Features and Specifications .....	8
Current Ratings .....	11
Soft Starter Sizing .....	14

## FAQs

Adaptive Acceleration Control.....	15
AC53 Utilisation Codes .....	16
Auto-Transformer Starters .....	17
Braking.....	18
Bypass Contactor .....	19
Cabling .....	20
Extreme Conditions .....	22
Fault finding.....	22
Flying Loads .....	23
Harmonics .....	23
IP Ratings .....	24
NEMA Ratings .....	25
Inside delta Connection .....	26
Key Benefits .....	27
Line Contactor .....	28
Minimum Start Current .....	29
Multiple Motors .....	30
Power factor correction .....	31
Motor Thermal Capacity .....	31
Jog.....	32
Reversing .....	32
Sealed Enclosures .....	33
Primary Resistance Starters .....	33
Short Circuit Protection, Type 1.....	34
Short Circuit Protection, Type 2.....	35
Semiconductor Fuse Selection, Type 2.....	36
Slip-Ring Motors .....	39
Soft Braking .....	40

Star/Delta Starters .....	41
Thermal Model Protection .....	43
Two Speed Motors .....	44
Types of Soft Starter .....	45

## MCD Bus Options

MCD Bus Options – General Notes .....	46
MCD 200 with MCD Remote Operator Option .....	47
MCD 200 Modbus Option .....	48
MCD 200 DeviceNet Option .....	50
MCD 200 Profibus Option .....	51
MCD 200 USB Option .....	52
MCD 500 with MCD Remote Operator Option .....	53
MCD 500 Modbus Option .....	54
MCD 500 DeviceNet Option .....	55
MCD 500 Profibus Option .....	56
MCD 500 USB Option .....	57
MCD 3000 with MCD Remote Operator Option .....	58
MCD 3000 Modbus Option .....	59
MCD 3000 DeviceNet Option .....	60
MCD 3000 Profibus Option .....	61

## Glossary

Glossary .....	62
Abbreviations .....	67



**Soft starter selection requires information on the intended application, the features required, and the current rating of the associated motor.**

**For applications with extreme or unusual conditions, consult the relevant Design Guide and/or your supplier.**

### For example:

- High altitude installation (> 1000 m)
- High ambient temperatures (> 40° C)
- High and/or frequent operating overloads
- High start frequency
- Slip-ring motor operation
- Part speed operation
- Horizontal mounting of the starter

## Common Applications

This table lists common applications for soft starters and it's nominal duty ratings.

Application	Normal	Heavy	Severe
Agitator	•		
Auger		•	
Blower (axial fan)		•	
Bottle Washer	•		
Centrifuge			•
Chipper		•	
Compressor, centrifugal (rotary)	•		
Compressor (reciprocating, unloaded)		•	
Compressor (screw, unloaded)	•		
Conveyor (loaded)		•	
Conveyor (unloaded)	•		
Crusher, cone	•		
Crusher, jaw		•	
Crusher, rotary (unloaded)		•	
Debarker	•		
Drilling machine	•		
Dust Collector	•		
Edger	•		
Escalator	•		
Fan, centrifugal (damped)	•		
Fan, centrifugal (undamped)		•	
Grinder	•		
Hydraulic power pack	•		
Mill, ball			•
Mill, hammer			•
Mill, roller		•	
Milliscreen	•		

Application	Normal	Heavy	Severe
Mixer (low viscosity)	•		
Mixer (high viscosity)		•	
Pelletiser		•	
Planer	•		
Press	•		
Pump, bore	•		
Pump, centrifugal	•		
Pump, positive displacement		•	
Pump, slurry		•	
Pump, submersible	•		
Pump, vacuum	•		
Re-pulper			•
Rotary table		•	
Sander	•		
Saw, band			•
Saw, circular	•		
Shredder		•	
Separator, liquids			•
Separator, solids		•	
Slabber	•		
Slicer	•		
Travelator	•		
Tumbler/Dryer		•	
Vibrating screen		•	
Winch		•	
Wire Draw machine (hydraulic)	•		

# MCD Soft Starter Features and Specifications

## MCD 201

- Soft start/stop: Timed voltage ramp
- Motor protection: not included
- System protection: not included
- Metering: not included
- Start/stop control: via inputs or via optional controller
- Network communication: optional
- Bypass: Internally bypassed

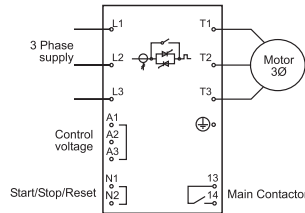

## MCD 202

- Soft start: Current limit
- Soft stop: Timed voltage ramp
- Motor protection: Thermistor, Motor overload, Phase imbalance
- System protection: Phase rotation, Excess start time, Bypass overload & Instantaneous overload
- Metering: optional extra
- Start/stop control: via inputs or via optional controller
- Network communication: optional
- Bypass: Internally bypassed

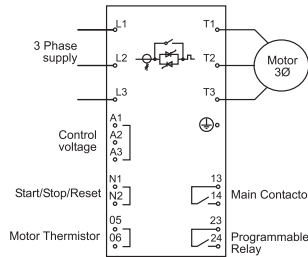

## MCD 201 and MCD 202

- Current: 7.5 kW ~ 110 kW @400 V
- Mains voltage: 200 ~ 575 VAC
- Supply frequency: 45 ~ 66 Hz
- Enclosure: 7.5 ~ 55 kW IP 20, 75 ~ 110 kW IP00

## MCD 500

- Soft start: Current limit, Current ramp, Kickstart, AAC Adaptive Acceleration Control
- Soft stop: Timed voltage ramp, AAC Adaptive Control, DC brake
- Motor protection: Motor connection, Power loss, Phase loss, Mains frequency, Current imbalance, Motor thermistor, Motor overload
- System protection: Phase sequence, Excess start time, Undercurrent, Instantaneous overcurrent, Bypass relay overload, Heatsink temperature
- Metering: Current, Motor temperature, Motor kW, motor kVA, Motor pf
- Control option: Local control panel plus remote inputs/outputs
- Network communication: options for DeviceNet, Modbus, Profibus and USB
- Bypass: 7.5 ~ 110 kW internally bypassed; 132 ~ 800 kW dedicated terminals for external bypass connection

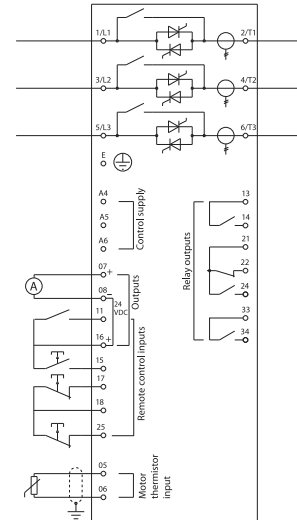

## MCD 500

- Current: 7.5 kW ~ 800 kW @400 V
- Mains voltage: 200 ~ 690 VAC
- Supply frequency: 50/60 Hz
- Enclosure: 7.5 ~ 55 kW IP 20, 60 ~ 800 kW IP 00

## MCD 3000

- Soft start: Current limit, Current ramp, Torque control, Torque boost
- Soft stop: Timed voltage ramp, Pump control, DC brake, Soft brake
- Motor protection: Thermistor, Motor overload, Phase imbalance
- System protection: Phase rotation, Excess start time, Undercurrent, Instantaneous overload
- Metering: Current, motor temperature
- Control option: Local pushbuttons plus remote inputs/outputs
- Network communication: AP ASCII plus options for DeviceNet, Modbus and Profibus
- Bypass: Dedicated terminals for external connection

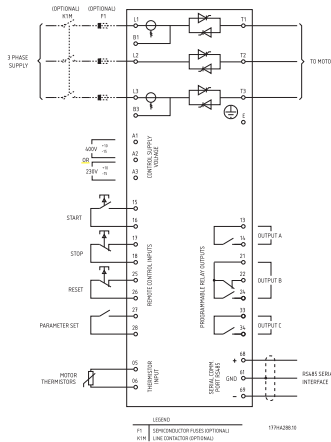

## MCD3000

- Current: 7.5 kW ~ 800 kW @400 V
- Mains voltage: 200 ~ 690 VAC
- Supply frequency: 50/60 Hz
- Enclosure: 7.5 ~ 132 kW IP 21, 185 ~ 800 kW IP 20

## MCD 100

- Micro Soft Start Controller for motors up to 11 kW
- Extremely robust SCR design with heavy ratings as standard
- Unlimited number of starts per hour
- Contactor style design for easy selection, installation and commissioning

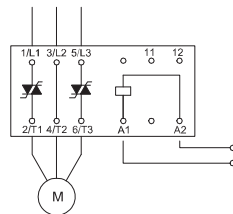

## MCD 100

- Current: 1.5 kW ~ 11 kW @400 V
- Mains voltage: 208 ~ 600 VAC
- Control voltage: 24 ~ 480 VAC/VDC
- Enclosure: 1.5 ~ 11 kW IP 20



**These duty ratings define the load requirements, not the starter capabilities. Starter capability is specified separately in User Manuals, Product Guides and WinStart. Use these charts to select a soft starter for a particular application.**

	Normal	Heavy	Severe
MCD5-0021	21 (32)	17 (26)	15 (22)
MCD5-0037	37 (56)	31 (47)	26 (39)
MCD5-0043	43 (65)	37 (56)	30 (45)
MCD5-0053	53 (80)	46 (69)	37 (55)
MCD5-0068	68 (102)	55 (83)	47 (71)
MCD5-0084	84 (126)	69 (104)	58 (87)
MCD5-0089	89 (134)	74 (112)	61 (92)
MCD5-0105	105 (158)	95 (143)	78 (117)
MCD5-0131	131 (197)	106 (159)	90 (136)
MCD5-0141	141 (212)	121 (181)	97 (146)
MCD5-0195	195 (293)	160 (241)	134 (201)
MCD5-0215	215 (323)	178 (268)	149 (223)
MCD5-0245	255 (383)	201 (302)	176 (264)
MCD5-0360	360 (540)	310 (465)	263 (395)
MCD5-0380	380 (570)	359 (539)	299 (449)
MCD5-0428	430 (645)	368 (552)	309 (463)
MCD5-0595	620 (930)	540 (810)	434 (651)
MCD5-0619	650 (975)	561 (842)	455 (683)
MCD5-0790	790 (1185)	714 (1072)	579 (869)
MCD5-0927	930 (1395)	829 (1244)	661 (992)
MCD5-1200	1200 (1800)	1200 (1800)	1071 (1607)
MCD5-1410	1410 (2115)	1319 (1979)	1114 (1671)
MCD5-1600	1600 (2400)	1600 (2400)	1353 (2030)

All ratings are for bypassed operation. Brackets denote ratings for inside delta connection.

	Normal	Heavy	Severe
MCD 201-007	18	17	Consult Danfoss for suitability
MCD 201-015	34	30	
MCD 201-018	42	36	
MCD 201-022	48	40	
MCD 201-030	60	49	
MCD 201-037	74	65	
MCD 201-045	85	73	
MCD 201-055	100	96	
MCD 201-075	140	120	
MCD 201-090	170	142	
MCD 201-110	200	165	
<hr/>			
MCD 202-007	18	17	Consult Danfoss for suitability
MCD 202-015	34	30	
MCD 202-018	42	36	
MCD 202-022	48	40	
MCD 202-030	60	49	
MCD 202-037	74	65	
MCD 202-045	85	73	
MCD 202-055	100	96	
MCD 202-075	140	120	
MCD 202-090	170	142	
MCD 202-110	200	165	

	Normal	Heavy	Severe
MCD3007	17	16	14
MCD3015	30	28	24
MCD3018	36	33	29
MCD3022	45	40	35
MCD3030	57	54	47
MCD3037	76	72	62
MCD3045	83	78	68
MCD3055	111	104	90
MCD3075	117	113	99
MCD3090	172	164	143
MCD3110	202	194	169
MCD3132	208	202	178
MCD3185	326 (489)	261 (392)	222 (333)
MCD3220	383 (575)	308 (462)	262 (394)
MCD3300	507 (761)	393 (590)	329 (493)
MCD3315	547 (820)	456 (684)	377 (566)
MCD3400	694 (1041)	567 (850)	458 (687)
MCD3500	822 (1233)	602 (904)	526 (789)
MCD3600	998 (1497)	797 (1195)	713 (1070)
MCD3700	1248 (1873)	990 (1485)	865 (1297)
MCD3800	1433 (2149)	1128 (1293)	961 (1442)

Brackets denote ratings for inside delta connection.

- The soft starter's current rating at the required start duty must be at least equal to the motor's nameplate rating. If the motor's nameplate rating is not available, approximate information is available from the following table.

Motor Power		Current rating at different voltages				
kW	HP	220-230 V	380-400 V	440 V	500 V	660-690 V
7.5	10	27	15.5	13.7	12	8.9
11	15	39	22	20.1	18.4	14
15	20	52	30	26.5	23	17.3
18.5	25	64	37	32.8	28.5	21.3
22	30	75	44	39	33	25.4
25	35	85	52	45.3	39.4	30.3
30	40	103	60	51.5	45	34.6
37	50	126	72	64	55	42
45	60	150	85	76	65	49
55	75	182	105	90	80	61
75	100	240	138	125	105	82
90	125	295	170	146	129	98
110	150	356	205	178	156	118
132	180	425	245	215	187	140
140	190	450	260	227	200	145
147	200	472	273	236	207	152
150	205	483	280	246	210	159
160	220	520	300	256	220	170
185	250	595	342	295	263	200
200	270	626	370	321	281	215
220	300	700	408	353	310	235
250	340	800	460	401	360	274
257	350	826	475	412	365	280
280	380	900	510	450	400	305
295	400	948	546	473	416	320
300	410	980	565	481	420	325
315	430	990	584	505	445	337
335	450	1100	620	518	472	355
355	480	1150	636	549	500	370
375	500	1180	670	575	527	395
400	545	1250	710	611	540	410
425	580	1330	760	650	574	445
445	600	1400	790	680	595	455
450	610	1410	800	690	608	460
475	645	1490	850	730	645	485
500	680	1570	900	780	680	515
560	760	1750	1000	860	760	570
600	800	1875	1085	937	825	625
650	870	2031	1176	1015	894	677
700	940	2187	1266	1093	962	729
750	1000	2343	1357	1172	1031	781
800	1070	2499	1447	1250	1100	833
850	1140	2656	1537	1328	1168	885
900	1250	2812	1628	1406	1237	937
950	1275	2968	1718	1484	1306	989
1000	1340	3124	1809	1562	1375	1041

Note: Information is based on a 4-pole motor

ACC is the next evolution in soft starter technology.

Using ACC, the soft starter learns your motor's performance during start and stop, then adjusts control to optimize performance.

The soft starter estimates the motor's speed throughout each AAC start and stop, and adjusts power to the motor to provide the selected acceleration or deceleration profile.

ACC is largely unaffected by changes in load, and is particularly suitable for pumping situations.

ACC offers three starting and stopping profiles: early, constant and late acceleration/deceleration.

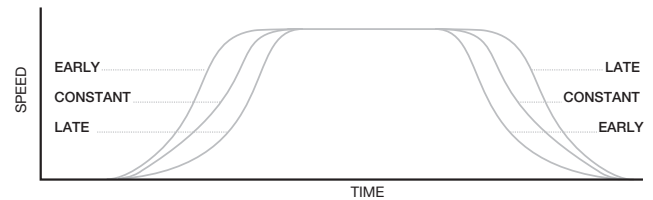

**ACC is only available on MCD 500 soft starters.**



AC53 utilisation codes describe the current rating for soft starters under specified operating conditions.

The utilisation code determines the maximum motor size the soft starter can be used with, under the specified conditions. The current rating may change under different operating conditions.

### AC53a: Non-bypassed soft starters

The rating depends on the number of starts per hour, the length and current level of the start, and the percentage of the operating cycle that the soft starter will be running (passing current).

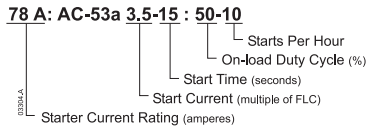

### AC53b: Bypassed soft starters

The rating depends on the number of starts per hour, the length and current level of the start, and the amount of time the soft starter will be off (not passing current) between starts.

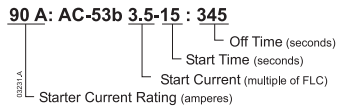

**Danfoss soft starters provide a relay output, which can be used to control the main contactor. Ensure that the inrush VA rating of the contactor coil does not exceed the rating of the soft starter's relay input.**

## Auto-Transformer Starters: How does soft start compare to auto-transformer starting?

Soft starters are much more flexible than auto-transformer starters and provide a much smoother start, generally at a lower cost.

Auto-transformer starters cannot accommodate varying load conditions (e.g. loaded or unloaded starts) and the start torque cannot be freely adjusted to match motor and load characteristics. Damaging torque and current transients still occur at the steps between voltages, and auto-transformer starters are not capable of providing soft stop. Auto-transformer starters are large and expensive, especially if high start frequency is required.

## Braking: What are DC braking and soft braking?

DC braking and soft braking both reduce motor stopping time, unlike soft stopping which increases the stop time on frictional loads.

DC braking uses DC injection to reduce the motor's stopping time. The soft starter slows the motor to approximately 70% of its full running speed, then applies brake torque to stop the motor in the selected braking time.

MCD 3000 soft starters can provide DC braking via a dedicated braking contactor.

DC braking support is built into MCD 500 soft starters, and no additional equipment is required. MCD 500 DC braking controls all three phases, which reduces stress on the motor compared with two phase braking solutions.

Soft braking uses reversing contactors on the input side of the starter to start the motor in the reverse direction, which applies braking torque to the load.

Soft braking causes less motor heating and provides more braking torque for a given current than DC braking, and is better for extremely high inertia loads (e.g. band saw and circular saw applications).

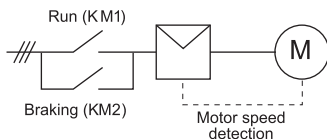

## Bypass Contactors: When should a bypass contactor be used?

Bypass contactors bridge out the SCRs when the motor is running at full speed, eliminating heat dissipation during run. This allows the soft starter to be installed in enclosures without the need for forced-air cabinet ventilation.

If a soft starter is installed in a totally sealed enclosure (>IP 54) it must be bypassed.

Bypass contactors should be AC1 rated for the motor FLC (the bypass contactor does not carry start current).

Soft starters may be internally or externally bypassed:

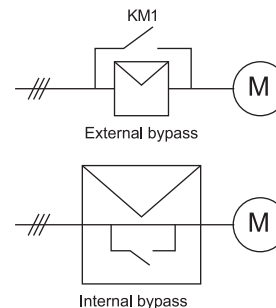

**MCD 200 soft starters are internally bypassed, with built-in bypass relays.**  
**MCD 500 soft starters are internally bypassed up to 110 kW. Non-bypassed models include relay outputs to control an external bypass contactor. Dedicated bypass terminals mean motor protection still operates even when the starter is bypassed.**  
**MCD 3000 soft starters provide relay outputs to control an external bypass contactor. Dedicated bypass terminals mean motor protection still operates even when the soft starter is bypassed.**

## Cabling: How is cable selected for a soft starter installation?

Cable selection criteria depends on the circuit and the location of the soft starter within the circuit.

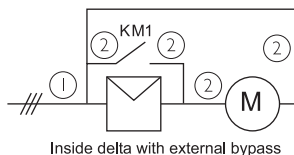
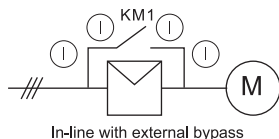

1. Supply cable rating > nominal fuse/MCCB rating > motor FLC x 1.2
2. Inside delta motor circuit cable rating > motor FLC x 0.7



**Installation factors (including grouping, ambient temperature, method of installation and single or parallel cabling) may affect the cable's current rating. Always follow the manufacturer's guidelines and derate appropriately.**

## Cabling: What is the maximum allowable cable, distance between a soft starter and the motor?

The maximum distance between the soft starter and motor depends on the voltage drop and the cable capacitance.

Cable must be selected so that when the motor is running fully loaded, the voltage drop at the motor terminals does not exceed the limit specified in local electrical regulations.

For distances greater than 500 metres, cable capacitance may be a factor. Contact Danfoss with details of the soft starter model, mains voltage and frequency.

## Extreme Conditions: How can soft starters be selected for extreme conditions?

Soft starter ratings are based on specific operating conditions. These generally specify start time, start current, starts per hour, duty cycle and environmental factors such as ambient temperature and altitude. If the soft starter will be used outside these conditions, the rating must be revised according to the manufacturer's instructions.



**Ratings for Danfoss soft starters are published in the soft starter's Operating Instructions. Alternatively, WinStart can be used to model requirements outside the published ratings.**

## Fault finding: What are the key questions?

To assist your service engineer, they require the following information:

- Model and serial number of the soft starter
- Motor kW and FLC
- Main supply voltage and frequency
- Control voltage
- Application (e.g. pump, compressor)
- Time installed before failure
- Details of other soft starters on the supply bus. Are these failing?
- If the soft starter trips, details of the code and mode of operation
- The installation's power and control schematic diagram

## Flying Loads: Are soft starters suitable for use with a flying load?

Soft starters can be used with flying loads (motors that are already rotating), without any special wiring or configuration.

As a general rule, the faster the motor is rotating in the forward direction, the shorter the start time will be.

If the motor is rotating in the reverse direction, it will be slowed to a standstill before accelerating in the forward direction. In this case allow for the extended start time when rating the soft starter.

## Harmonics: Are harmonics an issue for soft starter applications?

Harmonics are voltages and currents that create unwanted heating in motors, cables and other equipment. Harmonics may also disrupt operation of other electrical and electronic equipment.

Soft starters generate very low levels of harmonics, only during starting or soft stopping. According to IEC 60947-4-2 (8.3.2.1.1), "harmonic emissions are of short duration during starting, and there are no significant emissions in the FULL-ON state". No special considerations or filtering are required for soft start applications.



**All MCD soft starters comply with the EMC directive on radiofrequency emissions and immunity.**

IEC 60529 specifies protection ratings for enclosures. The first number describes the protection against solid objects, the second number describes the level of protection against entry of liquids. Example IP 20 is highlighted below.

IP	Solids	Liquids
0	No protection	No protection.
1	Protected against solid objects greater than 50 mm (e.g. accidental touching by hand).	Protected against vertically falling drops of water (e.g. condensation).
2	Protected against solid objects greater than 12 mm (e.g. fingers).	Protected against direct sprays of water up to 15° from vertical.
3	Protected against solid objects greater than 2.5 mm (e.g. tools or wires)	Protected against sprays of water up to 60° from vertical.
4	Protected against solid objects greater than 1 mm (e.g. tools and small wires).	Limited protection against water sprayed from all directions (limited ingress permitted).
5	Limited protection against dust (some ingress but no harmful deposit).	Limited protection against low pressure jets of water from all directions (limited ingress permitted).
6	Complete protection against dust.	Protected against strong jets of water (limited ingress permitted).
7		Protected against the effects of immersion in water between 15 cm and 100 cm.
8		Protected against extended immersion in water under pressure.

### Examples

- MCD200-007 ~ MCD200-055 is IP 20
- MCD200-075 ~ MCD200-110 is IP 00 IP 20 with optional finger guard kit, Order code 175G9007
- MCD5-0021 ~ MCD5-0105 is IP 20
- MCD5-0131 ~ MCD5-1600 is IP 00 IP 20 with optional finger guard kit.

Order codes are:

- MCD5-0131~0215: 175G5662
- MCD5-0245: 175G5663
- MCD5-0360~0927: 175G5664
- MCD5-1200~1600: 175G5665
- MCD3007 ~ MCD3132 is IP 21
- MCD3185 ~ MCD3800 is IP 20

NEMA 250 is a product standard for enclosure design and performance.

NEMA	Protection against solid objects	Approx. IP equivalent
1	Indoor, protection from contact.	IP 23
2	Indoor, limited protection from dirt and water.	IP 30
3	Outdoor, some protection from rain, sleet, windblown dust and ice.	IP 64
3R	Outdoor, some protection from rain, sleet and ice.	IP 32
4	Indoor or outdoor, some protection from windblown dust, rain, splashing water, hose-directed water and ice.	IP 66
4X	Indoor or outdoor, some protection from corrosion, windblown dust, rain, splashing water, hose-directed water and ice.	IP 66
6	Indoor or outdoor, some protection from ice, hose-directed water, entry of water when submerged at limited depth.	IP 67
12	Indoor, protection from dust, falling dirt and dripping non-corrosive liquids.	IP 55
13	Indoor, protection from dust, spraying water, oil and non-corrosive liquids.	IP 65

### Warning:

Conversion from NEMA to IEC (IP) degrees of enclosure **not** to be used for converting from IEC to NEMA.

Please refer to NEMA publication 250, 2003.

## Inside delta Connection: What is “inside delta” connection?

With inside delta (six wire connection), the soft starter SCRs are in series with each motor winding so that the soft starter carries only phase current, not line current. The soft starter can thus control a motor with greater full load current than normal.

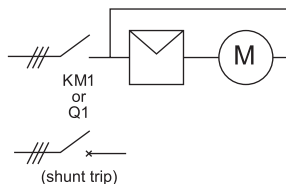

Inside delta connection is only possible with motors that allow each end of all three motor windings to be connected separately, and not all soft starters can be connected using inside delta. A line contactor or shunt trip MCCB must always be used to disconnect the motor and soft starter from the supply in the event of a trip.

Inside delta connection simplifies replacement of star/delta starters because the existing wiring can be used. In new installations, inside delta connection may reduce the size and cost of the soft starter, but there are additional costs for the line contactor/shunt trip MCCB and extra cabling.



**MCD 200 soft starters cannot be installed using inside delta connection.**

**MCD 500 soft starters have built-in support for inside delta connection.**

**MCD 3000 soft starters can be installed using an inside delta connection (models MCD3185 ~ MCD3800 only; an additional installation kit is required).**

## Key Benefits: What are the key benefits of soft start?

Soft start enhances motor start performance in many ways.

- The gradual application of voltage or current avoids the voltage and current transients associated with electro-mechanical reduced voltage starters.
- Acceleration is also smoother, as soft start avoids the torque transients associated with electro-mechanical reduced voltage starters.
- Constant current control gives higher torque as motor speed increases, resulting in lower start currents and/or shorter start times
- Start performance can be adjusted to suit the motor and load, including exact control over the current limit.
- Soft starting provides reliable performance even with frequent starts, or if load characteristics vary between starts (e.g. loaded or unloaded).

Soft starters also provide a range of features not available from other reduced voltage starters. This includes soft stop, which helps eliminate water hammer and DC braking.



**Other features such as built-in protection for the motor and system, and metering and monitoring options, can reduce the overall installed cost of the equipment and reduce the long-term maintenance requirement.**

## Line Contactors: When should a line contactor be used?

Soft starters can be installed with or without a line contactor.

A line contactor disconnects the SCRs from the supply when the motor is not in use. This isolates the soft starter, and protects the SCRs from damage due to severe overvoltage (e.g. lightning strikes) – SCRs are most susceptible to overvoltage damage when in the off state. The soft starter is also isolated from the supply in the event of a trip.

A line contactor may be required by local electrical regulations and should be AC3 rated for the motor FLC.



**The line contactor can be controlled via the soft starter's relay output. The inrush VA rating of the contactor coil must not exceed the rating of the soft starter's relay output.**

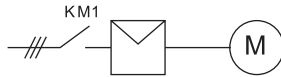

## Minimum Start Current: What is the minimum start current required by a soft starter?

Soft starters can limit start current to any specified level, but the practical minimum depends on the motor and load. Reducing the start current reduces the torque produced by the motor, so the load will stall if the start current is too low. In order to start successfully, the motor must produce more acceleration torque than the load requires throughout the start.

Successful start:

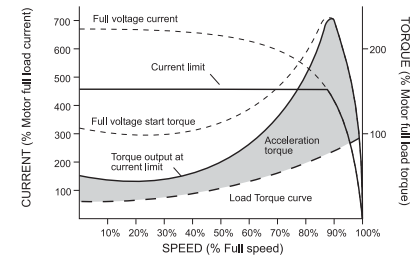

Unsuccessful start:

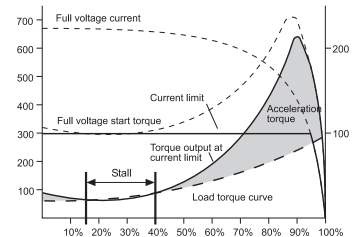

Start current can be estimated based on previous experience, or the motor and load speed/torque curves can be analysed for a precise calculation.

## Multiple motors: Can one soft starter be used to control multiple motors?

A single soft starter can be used to control multiple motors, either in sequence or in parallel, provided the soft starter is correctly selected for the application.

### Motors in sequence

For two or more motors in sequence, the soft starter must be capable of bearing the total start duty.

Installation requires additional wiring, plus separate overload protection and line and bypass contactors for each motor. The additional installation costs may be greater than the cost of individual soft starters.

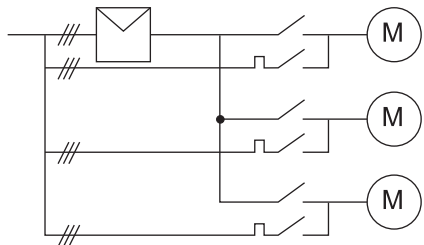

\* This control method is complex and would require the use of a PLC or smart relay.

## Power factor correction: Can power factor correction be used with soft starters?

Power factor correction (PFC) capacitors can be used with soft starters, provided they are switched in using a dedicated contactor when the motor is running at full speed. PFC must always be installed on the input side of the soft starter; connecting PFC capacitors to the output of a soft starter causes resonance between the inductance of the motor and the power factor capacitance, resulting in severe overvoltage and equipment failure.

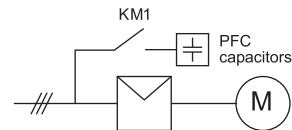

The contactor should be AC6 rated for the motor full load current. PFC capacitors can be sized using the following formula:

$$\text{kVA (Cap)} = \frac{\sqrt{3} \times V_{\text{line}} \times 0.8 \times \text{motor no load current}}{1000}$$

## Motor thermal capacity: What is it?

Thermal capacity, also called “maximum locked rotor time” or “maximum DOL start time”, describes the maximum time a motor can run at locked rotor current from cold. This information is usually available from the motor datasheet.

The MCD 202 and MCD 3000 overload protection can be set to match the motors thermal capability using the motors locked rotor time (cold).



## Jog: What is the jog function?

MCD 500 includes a slow speed “jog” function which allows the operator to run the motor at reduced speed (approximately 11% of full speed) in either the forward or reverse direction. This is ideal for positioning of loads such as mixers or hopper bins ready for unloading.

## Reversing: Can soft starters be used to reverse motor direction?

On their own, soft starters cannot run motors in reverse direction at full speed. However, an arrangement of forward and reverse contactors can be used to provide the same effect.

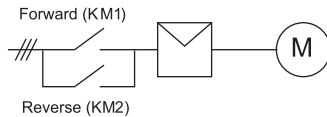

MCD 500 soft starters offer a part speed function that runs the motor at slow speed in either forward or reverse direction, without a reversing contactor. Reverse operation is limited to short periods at a fixed slow speed.

## Sealed enclosures: Can soft starters be installed in sealed enclosures?

Soft starters can be installed in sealed enclosures, provided the ambient temperature within the enclosure will not exceed the soft starter's rated temperature.

All heat generated within the enclosure must be dissipated, either by ventilation or through the enclosure's walls. This includes heat not only from the soft starter but also from other components such as fuses, cabling and switchgear. Heating from the soft starter can be minimised by installing the starter in a bypassed configuration. To minimise external heating, protect the enclosure from direct sunlight.

WinStart includes a function to help design enclosure ventilation.

## Primary Resistance Starters: How does soft start compare to primary resistance starting?

Soft starters are more flexible and reliable than primary resistance starters.

Primary resistance starters cannot accommodate varying load conditions (e.g. loaded or unloaded starts) and the start torque cannot be fine-tuned to match motor and load characteristics. Performance may vary with multiple starts in close succession, because the start profile changes as the resistance heats up. Damaging torque and current transients still occur at the steps between voltages, and primary resistance starters are not capable of providing soft stop. Primary resistance starters are large and expensive, and liquid resistance starters require frequent maintenance.

## Short Circuit Protection: What is required for Type 1 short circuit protection of a soft starter?

Type 1 protection requires that in the event of a short circuit on the output of a soft starter the fault must be cleared without risk of injury to personnel. The soft starter may or may not be operational after the fault.

Type 1 protection is provided by HRC fuses or a MCCB within the motor branch circuit, which must be able to bear the required motor start current.

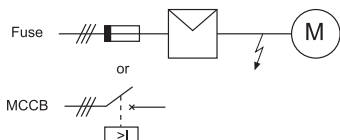

Typical selection criteria are as follows:

Starter type	Protection Type	Rating (% Motor FLC), Start Current	
		< 350% FLC 15 seconds	> 350% FLC 15 seconds
MCD 200	Fuse (non time delayed)	175%	200%
	Fuse (time delayed)	150%	175%
	MCCB*	150 – 200%	
MCD 500 MCD 3000	Fuse (non time delayed)	150%	
	Fuse (time delayed)	125%	
	MCCB*	150 – 200%	

\* Consult the manufacturer's specification.

Maximum fuse ratings for Type 1 motor protection are specified in UL and IEC standards.

Fuse	Rating (% Motor FLC)
Fuse (non-time delayed)	300%
Fuse (time delayed)	175%

## Short Circuit Protection: What is required for Type 2 short circuit protection of a soft starter?

Type 2 protection requires that in the event of a short circuit on the output of a soft starter the fault must be cleared without risk of injury to personnel or damage to the soft starter.

Type 2 protection is provided by semiconductor fuses, which must be able to carry motor start current and have a total clearing  $I^2t$  less than the  $I^2t$  of the soft starter SCRs.

Semiconductor fuses for Type 2 circuit protection are additional to HRC fuses or MCCBs that form part of the motor branch circuit protection.

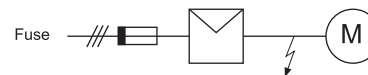

Refer to the soft starter's Design Guide for semiconductor fuse recommendations.

## Semiconductor Fuse Selection: Type 2

- Semiconductor fuses may be used with MCD soft starters. Use of semiconductor fuses will provide Type 2 coordination and reduce the potential of SCR damage due to transient overload currents and short circuits. MCD soft starters have been tested to achieve Type 2 coordination with semiconductor fuses. The following table provides a list of suitable Bussman fuses. If selecting alternate brands ensure the selected fuse has a lower total clearing I<sub>2</sub>t rating than the SCR, and can carry start current for the full start duration.

MCD 200	200~575 V		SCR I <sup>2</sup> t (A <sup>2</sup> s)
	Bussmann Fuse Square Body (170M)	Bussmann Fuse British Style (B588)	
MCD200-007	170M-1314	63 FE	1150
MCD200-015	170M-1317	160 FEE	8000
MCD200-018	170M-1318	160 FEE	10500
MCD200-022	170M-1318	180 FM	15000
MCD200-030	170M-1319	180 FM	18000
MCD200-037	170M-1321	250 FM	51200
MCD200-045	170M-1321	250 FM	80000
MCD200-055	170M-1321	250 FM	97000
MCD200-075	170M-1322	500 FMM	168000
MCD200-090	170M-3022	500 FMM	245000
MCD200-110	170M-3022	500 FMM	320000

- Semiconductor fuses listed below are manufactured by Bussman and should be ordered directly from Bussman or their local supplier. Instruction for selection for alternative semi-conductor fuses is available from Danfoss.

MCD 500	400 V		690 V		SCR I <sup>2</sup> t (A <sup>2</sup> s)
	Square Body	British Style	Square Body	British Style	
MCD5-0021	170M1314	63FE	170M1314	63FE	1150
MCD5-0037	170M1316	120FEE	170M1316	120FEE	8000
MCD5-0043	170M1318	120FEE	170M1318	120FEE	10500
MCD5-0053	170M1318	200FEE	170M1318	200FEE	15000
MCD5-0068	170M1319	200FEE	170M1318	200FEE	15000
MCD5-0084	170M1321	200FEE	170M1319	200FEE	51200
MCD5-0089	170M1321	280FM	170M1321	280FM	80000
MCD5-0105	170M1321	280FM	170M1321	280FM	125000
MCD5-0131	170M1321	280FM	170M1321	280FM	125000
MCD5-0141	170M2621	450FMM	170M2621	450FMM	320000
MCD5-0195	170M2621	450FMM	170M2621	450FMM	320000
MCD5-0215	170M2621	450FMM	170M2621	450FMM	320000
MCD5-0245	170M2621	450FMM	170M2621	450FMM	320000
MCD5-0360	170M6010	---	170M6010	---	238000
MCD5-0380	170M6011	2 x 400FMM	---	2 x 400FMM	320000
MCD5-0428	170M6011	---	---	---	320000
MCD5-0595	170M6015	2 x 630FMM	170M6014	---	1200000
MCD5-0619	170M6015	2 x 630FMM	170M6014	---	1200000
MCD5-0790	170M6017	---	170M6016	---	2530000
MCD5-0927	170M6019	---	170M6019	---	4500000
MCD5-1200	170M6021	---	---	---	4500000
MCD5-1410	170M6021	---	---	---	6480000
MCD5-1600	---	---	---	---	12500000

## Slip-Ring Motors: Are soft starters suitable for use with slip-ring motors?

- Semiconductor fuses listed below are manufactured by Bussmann and should be ordered directly from Bussmann or their local supplier. Instruction for selection for alternate semi-conductor fuses is available from Danfoss.

MCD3000	Bussmann Fuse 400V	Bussmann Fuse 690V	SCR I <sup>2</sup> t (A <sup>2</sup> s)
MCD3007	170M1315	170M1314	1150
MCD3015	170M1318	170M1317	8000
MCD3018	170M1319	170M1317	10500
MCD3022	170M1319	170M1318	15000
MCD3030	170M1319	170M2616	15000
MCD3037	170M1322	170M1320	51200
MCD3045	170M1322	170M1321	80000
MCD3055	170M1322	170M1322	97000
MCD3075	170M2621	170M1322	97000
MCD3090	170M3021	170M3020	245000
MCD3110	170M3023	170M3023	414000
MCD3132	170M3023	170M3023	414000
MCD3185	170M6011	170M4145	238000
MCD3220	170M6012	170M6011	320000
MCD3300	170M6014	170M4018	781000
MCD3315	170M5017	170M6014	1200000
MCD3400	170M6019	170M6017	2532000
MCD3500	170M6021	170M6151	4500000
MCD3600	170M6021	170M6151	4500000
MCD3700	170M6021	2 x 170M5018	6480000
MCD3800	170M6021	2 x 170M5018	13000000

Soft starters are suitable for use with slip-ring motors provided that the motor can still deliver the torque required to accelerate the load. Soft starters are not suitable if the load requires extremely high start torque, or if the slip-ring motor is intended to provide speed control. When considering a soft starter for slip-ring applications, a trial should be conducted to verify the performance.

To develop starting torque, some resistance must remain in the rotor circuit during motor starting. This resistance must be bridged out using a contactor (AC2 rated for rotor current) once the motor is running close to full speed.



Rotor resistance (R) can be sized using the following formula:

$$R \text{ (per phase)} = 0.2 \times \frac{V_R}{\sqrt{3} \times I_R}$$

Where  $V_R$  = open circuit rotor voltage

$I_R$  = full load rotor current

$$\text{Power (per phase)} = \frac{20\% \times \text{motor kW}}{3}$$

## Soft Braking: What is soft braking?

Soft braking is a technique used by the soft starter to reduce motor stopping time, unlike soft stopping which increases the stop time on frictional loads. Soft braking requires the use of reversing contactors.

When the soft starter receives a stop command, it operates the reversing contactor connected on its input side to soft start the motor in the reverse direction. This applies braking torque to the load.

Motor speed detection is required to shut down the braking at motor standstill.

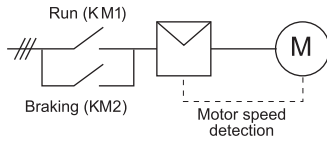

Soft starters can also use 'DC braking' to reduce the stopping time, but soft braking causes less motor heating and provides more braking torque for a given current, and is better for extremely high inertia loads (e.g. band saw and circular saw applications).

## Star/Delta Starters: How does soft start compare with star/delta starting?

Soft starters are much more flexible than star/delta starters and provide a smooth start with no risk of transients.

Star/delta starters cannot accommodate varying load conditions (e.g. loaded or unloaded starts) and the start torque cannot be adjusted to match motor and load characteristics. In addition, the open transition between star and delta connection causes damaging torque and current transients. Star/delta starters are not capable of providing soft stop.

However, star/delta starters may be cheaper than a soft starter and they may limit the start current to a lower level than a soft starter when used on an extremely light load. However, severe current and torque transients may still occur.

## Star/Delta Starters: Can soft starters be used to replace star/delta starters?

If the soft starter supports inside delta connection, simply connect it in place of the star/delta starter.

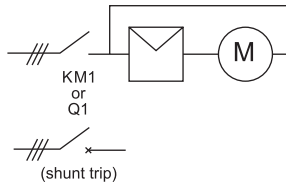

If the soft starter does not support inside delta connection, connect the delta connection to the output side of the soft starter.

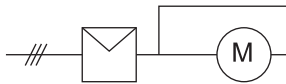

**MCD 500 soft starters include built-in support for inside delta connection.**

**MCD 3000 soft starters support inside delta connection (models MCD3185 ~ MCD3800 only; an additional installation kit is required).**

## Thermal Model Protection: How is a motor thermal model different from other forms of overload protection?

The motor thermal model used in MCD soft starters offers precise motor protection normally only available from high-end motor protection relays. The thermal model constantly models motor temperature, based on information on the motor's design characteristics and actual operation. The thermal model accounts for different heating and cooling rates when the motor is starting, running or stopped. Accurate modelling allows the motor to be used to its maximum potential without nuisance tripping.



**The MCD 500 uses an advanced second order thermal model, which models iron and copper losses separately. This gives more precise modelling and provides greater protection for the motor.**

Compared with a motor thermal model, thermal overload relays are less precise.

They do not account for iron loss or for different cooling rates at different stages of motor operation, and cannot be adjusted to match the characteristics of the individual motor because the mass of the bimetal strips is fixed. The bimetal strips are also affected by their own ambient temperature, which may be different from the motor's ambient temperature.

Thermal modelling is also superior to inverse time-current and I<sup>2</sup>T electronic overloads, which do not account for iron loss or for different cooling rates at different stages of motor operation. They offer only limited adjustment and the trip curves do not closely match motor heating. Inverse time-current protection also does not allow for motor temperature before the overload.

## Two-Speed Motors: Are soft starters suitable for use with two-speed motors?

Soft starters are suitable for use with Dahlander and dual winding motors, provided that separate motor protection is used for both low and high speed operation.

Dual-winding motors have one shaft with two separate pole configurations (e.g. 4 pole and 8 pole), providing two different speeds. The speed is selected using external contactors (AC3 rated).

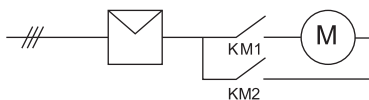

Dahlander motors are often used for two-speed compressor or fan applications. The motor windings are externally configured using contactors for high speed (dual star) and low speed (delta) operation.

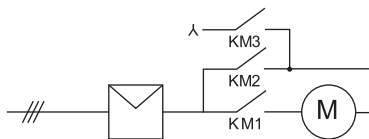

KM1, KM3 = High speed  
KM2 = Low speed



**MCD 201 soft starters are designed for use with external motor protection devices and are ideal for two-speed motor applications. MCD 202 soft starters have motor protection built in and are less suitable for two-speed applications.**

**MCD 500 and MCD 3000 soft starters offer dual motor settings, which allows separate start profiles to be configured for each speed.**

## Types of Soft Starter: What are the different types of soft starters?

There are three different types of soft starter which offer different features and control the motor in different ways.

1. Torque controllers control only one phase during start. This reduces the torque shock at start but does not reduce start current. Torque controllers must be used in conjunction with a direct on-line starter.

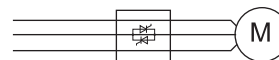

2. Soft starters which control two phases can reduce start current as well as eliminating torque transients, and are suitable for normal and heavy duty loads, but not severe loads. The start current on the uncontrolled phase is slightly higher than the two controlled phases.



3. Soft starters which control all three phases provide the maximum level of soft start control and are the only soft start solution that is suitable for severe duty applications.

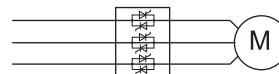

All bus options have the ability to:

- Control the soft starter
- Monitor the soft starter status
- Monitor the soft starter trip state
- Monitor the soft starter current (not available on MCD 201)
- Monitor the soft starter thermal model overload temperature (not available on MCD 201)

Parameters can also be uploaded to or downloaded from MCD 500 soft starters on Modbus, DeviceNet or Profibus networks.

In order for the MCD 500 to accept commands from the serial network, the soft starter must be in Auto On mode and links must be fitted to terminals 17 and 25 to 18. In Hand On mode, the starter will not accept commands from the serial network but the starter's status can still be monitored.

The following information is a general guide to MCD 500, MCD 3000 and MCD 200 bus options. Refer to the relevant installation instructions and users manual for more detail.

This requires an MCD Serial Interface Module which clips onto the side of the MCD 200. It is supplied with the MCD Remote Operator when ordering Cat. No: 175G9004.

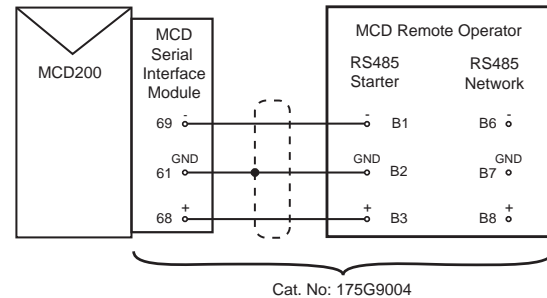

### Notes

- A single MCD Remote Operator and MCD Serial interface Module is required for each MCD 200.
- No set-up or configuration is required for operation.
- If two Remote Operators are required, the RS485 Network side of the first Remote Operator (terminals B6, B7, B8) must be connected to the RS485 Starter side of the second Remote Operator (terminals B1, B2, B3). The first Remote Operator is ordered using Cat. No: 175G9004 and the second Remote Operator is ordered using Cat. No: 175G3061.
- The Serial Interface Module is powered by the MCD 200. The Remote Operator requires an external 18-30 VAC/DC auxiliary supply.
- For more information on the MCD Remote Operator, refer to the User Manual (MG.17.Ex.02) located at [www.danfoss.com/drives](http://www.danfoss.com/drives).



There are two options to connect an MCD 200 to a Modbus network.

Option 1: Using an MCD Modbus Module (Cat. No: 175G9000)

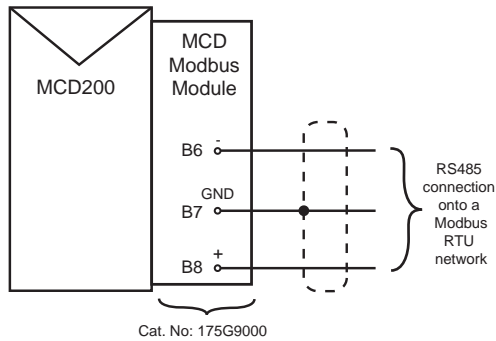

**Notes**

- A single Modbus Module is required for each MCD 200.
- Modbus Module settings are provided using two 8-way DIP switches on the module.
- Up to 31 Modbus Modules can be used as Modbus slave devices on a single Modbus RTU network.
- The Modbus Module is powered-up by the MCD 200.
- For more information about operating the MCD Modbus Module, refer to the Installation Instructions (MG.17.Fx.02), located at [www.danfoss.com/drives](http://www.danfoss.com/drives).

Option 2: Using the MCD Remote Operator as a Modbus RTU Gateway device (Cat. No: 175G9004)

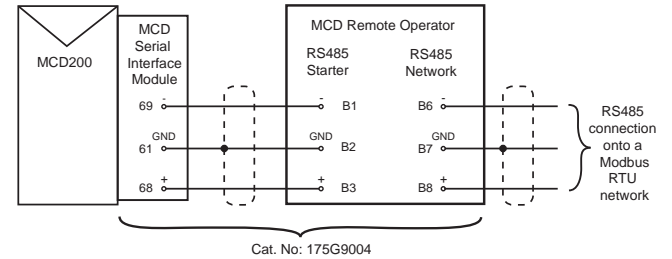

**Notes:**

- A single Remote operator and Serial Interface Module is required for each MCD 200.
- Parameters 1 to 5 of the Remote Operator are used to set it up as a Modbus slave device.
- Up to 31 Remote Operators can be used as Modbus slave devices on a single Modbus network.
- The Serial Interface Module is powered via the MCD200. The Remote Operator requires an external 18-30 VAC/DC auxiliary supply.
- For more information about operating the MCD Remote Operator as a Modbus RTU gateway, refer to the Installation Instructions (MG.17.Fx.02), Appendix A, located at [www.danfoss.com/drives](http://www.danfoss.com/drives).

## MCD 200 DeviceNet Option

This requires an MCD DeviceNet Module which clips onto the side of the MCD 200 (Cat. No: 175G9002).

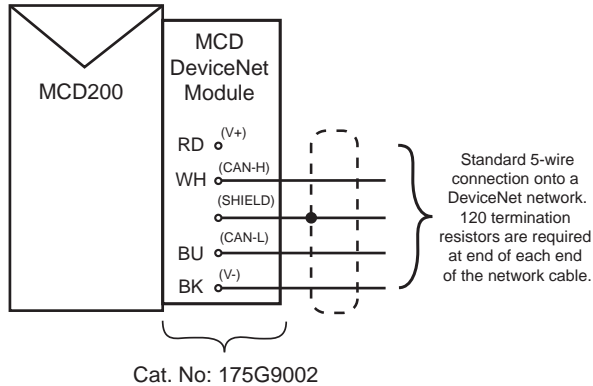

### Notes

- A single DeviceNet Module is required for each MCD 200.
- DeviceNet node address (MAC ID) and data rate are selected using three rotary switches on the DeviceNet Module.
- Up to 63 DeviceNet Modules can be used as DeviceNet slaves on a single DeviceNet network.
- The DeviceNet Module is powered via the network cable.
- The MCD DeviceNet Module is ODVA tested and certified.
- For more information on the MCD DeviceNet Module, refer to the Installation Instructions (MG.17.Hx.02), located at [www.danfoss.com/drives](http://www.danfoss.com/drives).

## MCD 200 Profibus Option

This requires an MCD Profibus Module which clips onto the side of the MCD 200 (Cat. No: 175G9001).

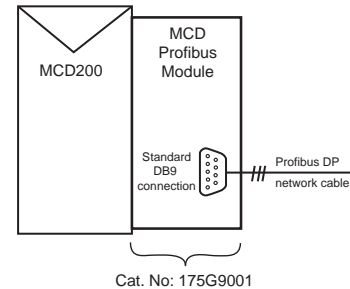

### Notes:

- A single Profibus Module is required for each MCD 200.
- Profibus node address is selected using two rotary switches. Data rate is automatically detected.
- Up to 31 Profibus Modules can be used as Profibus slaves on a single Profibus DP network.
- The Profibus Module requires an external 24 VDC auxiliary supply.
- The MCD Profibus Module is Profibus tested and certified.
- For more information on the MCD Profibus Module, refer to the Installation Instructions (MG.17.Gx.02) at [www.danfoss.com/drives](http://www.danfoss.com/drives).

This is achieved using the MCD USB Module (Cat. No: 175G9009).

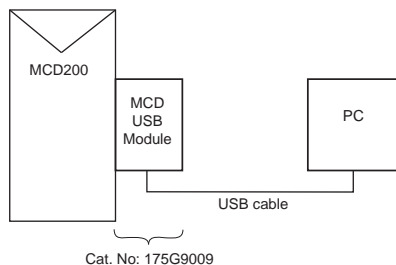

#### Notes

- A single USB Module is required for each MCD 200
- The USB Module acts as a physical interface when using PC based Master software such as WinMaster V4.x or MCT10
- Driver software must be installed before the USB Module can be used (supplied with the module on CD-ROM).
- For more information on the MCD USB Module, refer to the Installation Instructions (MI.17.Cx.02) located at [www.danfoss.com/drives](http://www.danfoss.com/drives)

This requires a MCD Modbus Module which clips onto the side of the MCD 500. The MCD Modbus Module is ordered using Cat. No: 175G9000 and the Remote Operator is ordered using Cat. No: 175G3061.

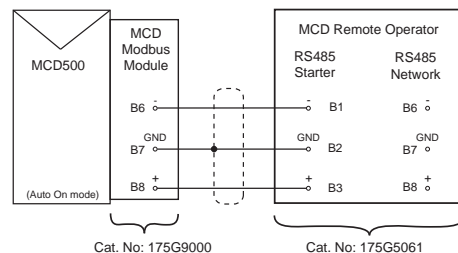

#### Notes

- A single MCD Remote Operator and MCD Modbus Module is required for each MCD 500.
- No set-up or configuration is required for the MCD Remote Operator.
- The MCD Modbus Module DIP switches must be set for ASCII, Address 20, Baud Rate 9600, No Parity, No Timeout.
- If two Remote Operators are required, the RS485 Network side of the first Remote Operator (terminals B6, B7, B8) must be connected to the RS485 Starter side of the second Remote Operator (terminals B1, B2, B3).
- The Modbus Module is powered by the MCD 500. The Remote Operator requires an external 18-30 VAC/DC auxiliary supply.
- For more information on the MCD Remote Operator, refer to the User Manual (MG.17.Ex.02)) located at [www.danfoss.com/drives](http://www.danfoss.com/drives).

This requires an MCD Modbus Module which clips onto the side of the MCD 500 (Cat. No: 175G9000).

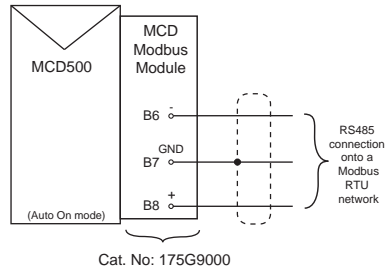

### Notes:

- A single Modbus Module is required for each MCD 500.
- Modbus Module settings are provided using two 8-way DIP switches on the module.
- Up to 31 Modbus Modules can be used as Modbus slave devices on a single Modbus RTU network.
- The Modbus Module is powered by the MCD 500.
- For more information about operating the MCD Modbus Module, refer to the Installation Instructions (MG.17.Fx.02), located at [www.danfoss.com/drives](http://www.danfoss.com/drives).

This requires an MCD DeviceNet Module which clips onto the side of the MCD 500 (Cat. No: 175G9002).

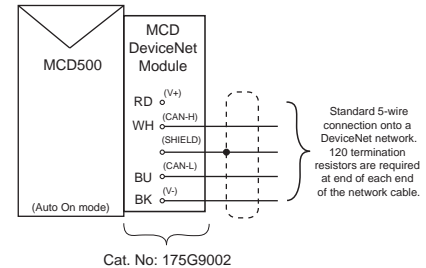

### Notes

- A single DeviceNet Module is required for each MCD 500.
- DeviceNet node address (MAC ID) and data rate are selected using three rotary switches on the DeviceNet Module.
- Up to 63 DeviceNet Modules can be used as DeviceNet slaves on a single DeviceNet network.
- The DeviceNet Module is powered via the network cable.
- The MCD DeviceNet Module is ODVA tested and certified.
- For more information on the MCD DeviceNet Module, refer to the Installation Instructions (MG.17.Hx.02), located at [www.danfoss.com/drives](http://www.danfoss.com/drives).

This requires an MCD Profibus Module which clips onto the side of the MCD 500 (Cat. No: 175G9001).

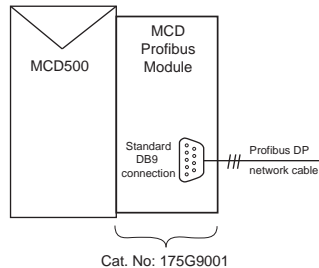

### Notes:

- A single Profibus Module is required for each MCD 500.
- Profibus node address is selected using two rotary switches. Data rate is automatically detected.
- Up to 31 Profibus Modules can be used as Profibus slaves on a single Profibus DP network.
- The Profibus Module requires an external 24 VDC auxiliary supply.
- The MCD Profibus Module is Profibus tested and certified.
- For more information on the MCD Profibus Module, refer to the Installation Instructions (MG.17.Gx.02) at [www.danfoss.com/drives](http://www.danfoss.com/drives)

This is achieved using the MCD USB Module (Cat. No: 175G9009).

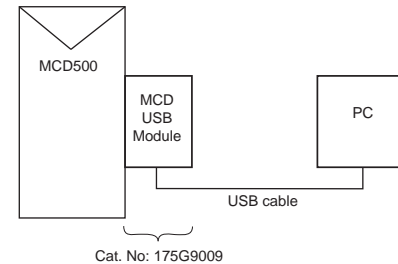

### Notes:

- A single USB Module is required for each MCD 500
- The USB Module acts as a physical interface when using PC based Master software such as WinMaster V4.x or MCT10
- Driver software must be installed before the USB Module can be used (supplied with the module on CD-ROM).
- For more information on the MCD USB Module, refer to the Installation Instructions (MI.17.Cx.02) located at [www.danfoss.com/drives](http://www.danfoss.com/drives)

This is achieved using the MCD Remote Operator (Cat. No: 175G3061).

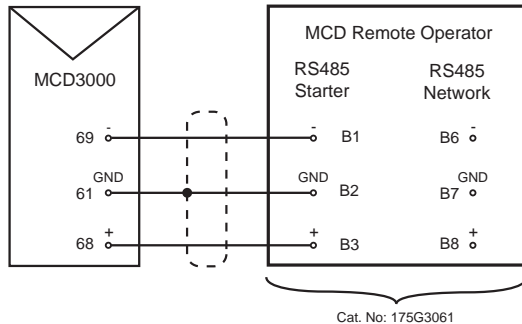

#### Notes

- A single Remote Operator is required for each MCD 3000
- If two Remote Operators are required, the RS485 Network side of the first Remote Operator (terminals B6, B7, B8) must be connected to the RS485 starter side of the second Remote operator (terminals B1, B2, B3)
- The Remote Operator requires an external 18-30 VAC/DC auxiliary supply.
- For more information on the MCD Remote Operator, refer to the Users Manual (MG.17.Ex.02) located at [www.danfoss.com/drives](http://www.danfoss.com/drives)

This is achieved using the MCD Remote Operator (Cat. No: 175G3061) as a Modbus RTU Gateway on the RS485 Network side.

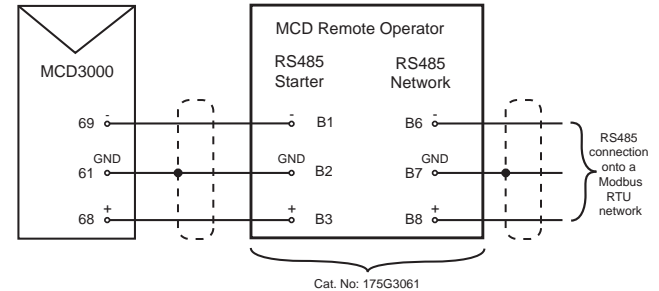

#### Notes

- A single Remote Operator is required for each MCD 3000
- Parameters 1 to 5 of the Remote Operator are used to set it up as a Modbus slave device.
- Up to 31 Remote Operators can be used as Modbus slave devices on a single Modbus network.
- The Remote Operator requires an external 18-30 VAC/DC auxiliary supply.
- For more information on operating the MCD Remote Operator as a Modbus RTU gateway, refer to the MCD Modbus Module Installation Instructions (MG.17-Fx.02), Appendix A, located at [www.danfoss.com/drives](http://www.danfoss.com/drives).

This is achieved using an externally fitted MCD3000 DeviceNet Gateway (Cat. No: 175G9005)

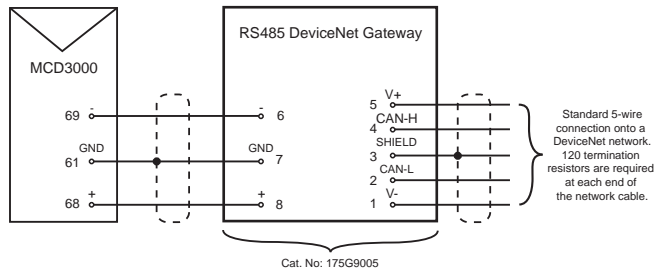

### Notes

- A Single DeviceNet Gateway is required for each MCD 3000
- DeviceNet node address (MAC ID) and data rate are set using DIP switches 1 to 8 in the DeviceNet Gateway.
- Up to 63 DeviceNet Gateways can be used as DeviceNet slaves on a single DeviceNet network.
- The DeviceNet Gateway is powered via the network cable.
- For more information on the MCD3000 DeviceNet Gateway, refer to the User Manual (MG.15.Ex.02) at [www.danfoss.com/drives](http://www.danfoss.com/drives).

This requires an externally fitted MCD Profibus Gateway (Cat. No: 175G0092)

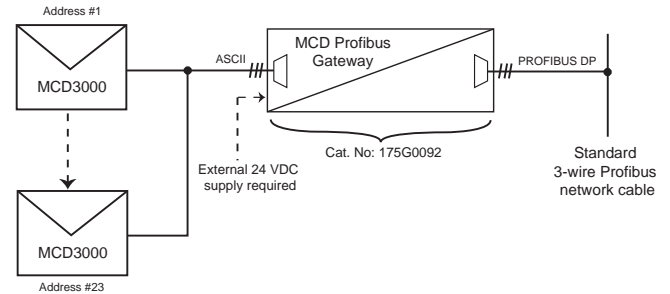

### Notes

- Up to 23 MCD 3000 soft starters can be used as ASCII slave devices with a single MCD Profibus Gateway.
- Each MCD 3000 must have a unique slave address starting from slave address 1 to the number of MCD3000 soft starters connected on the ASCII side of the MCD Profibus Gateway.
- The MCD Profibus gateway address (as seen by the Profibus DP master) is set using DIP switches 1 to 8 on the MCD Profibus Gateway.
- Both ASCII soft starter and Profibus DP cable termination is provided using standard DB9 connectors on the MCD Profibus Gateway.
- If you require use of the MCD Remote Operator with your installation, refer to product note 01, MCD Profibus Gateway and Remote Operator compatibility.
- For more information on the MCD 3000 Profibus Gateway, refer to the MCD Profibus Gateway User Manual (V2.03) located at [www.danfoss.com/drives](http://www.danfoss.com/drives).

**AAC – Adaptive Acceleration Control.** A new soft start control technique that allows the soft starter to estimate the motor's speed and control it to match a selected acceleration or deceleration profile.

**AC53 Utilisation Code** – The specification of a soft starter's current rating and intended operating conditions.

**Auger** – a device which uses a screw-like mechanism to move material or liquid, similar to the process that drives shavings up a drill bit and out of a hole during drilling.

**Blower** – see Fan.

**Bow thruster** – a steering mechanism in large ships which uses an impeller to force water through a tunnel in the bow below the waterline, causing the ship to turn.

**Centrifuge** – a machine which separates materials of different densities (e.g. solids from liquids or liquids from liquid mixtures).

**Chipper** – a machine which cuts large pieces of wood into chips.

**Compressor, centrifugal** – a machine which accelerates gas through a housing then converts the velocity energy to pressure energy. Normally used in heavy industrial applications.

**Compressor, positive displacement** – see Compressor, reciprocating.

**Compressor, piston** – see Compressor, reciprocating.

**Compressor, reciprocating** – a machine which compresses gas using pistons driven by a crankshaft. Small reciprocating compressors (up to 30 HP) are suitable for intermittent use and are commonly found in automotive applications. Larger units (up to 1000 HP) may be used for large industrial applications.

**Compressor, screw** – a machine which forces gas into a smaller space, using two meshed rotating positive-displacement screws.

**Crusher** – a machine which crushes material into smaller pieces.

**Crusher, cone** – a crusher consisting of two cones inside each other. Material is fed into the top of the large, outer cone and is broken into progressively smaller pieces by the rotation of the inverted inner cone.

**Crusher, jaw** – a crusher with one fixed side and one moving "jaw". The crusher is wider at the top than the bottom, and material is fed in at the top and moves down as it is broken into progressively smaller pieces.

**Crusher, roller** – a crusher with two horizontal rollers which rotate in opposite directions, crushing the material into smaller pieces.

**Current limit** – (1) a method of soft starting a motor by limiting the maximum amount of current the motor can draw during the start. (2) The maximum amount of current the soft starter will allow a motor to draw during a current limit start.

**Current ramp** – a method of soft starting a motor by gradually increasing the amount of current from a specified point to the current limit.

**Debarker** – a machine that strips bark from logs.

**Decanter** – a type of centrifuge.

**Edger** – a machine that cuts large pieces of timber into usable sizes.

**Escalator** – a type of conveyor which is used to move people up or down, much like a moving staircase.

**Fan, axial** – a fan with blades that turn around a shaft, forcing air along the shaft and across the axis of the fan.

**Fan, centrifugal** – a fan which pulls air in near the shaft and forces it out through an opening in the outer edge of the fan casing. A centrifugal fan produces more pressure for a given air volume than an axial fan.

**Fan, radial** – see Fan, centrifugal.

**Full load current** – the amount of current a motor will draw when operating fully loaded and at full speed.

**Full load torque** – the amount of torque a motor will produce when operating fully loaded and at full speed.

**Grinder** – a machine which reduces the size of small particles through compression and attrition. For machines operating on larger items, see Crusher.



**Gyratory crusher** – see Crusher, cone.

**Hydraulic power pack** – A hydraulic pump which is used to supply pressurised hydraulic fluid.

**IP rating** – a description of the soft starter's level of physical protection, according to IEC 60529.

**Kickstart** – a method of soft starting a motor which uses a high level of current for a short period at the beginning of a current limit or current ramp start.

**Locked rotor current** – the amount of current a motor will draw in locked rotor situations, including full voltage starts. Locked rotor current is described as a percentage of full load current.

**Locked rotor time** – the maximum amount of time a motor can safely run at locked rotor current.

**Locked rotor torque** – the amount of torque a motor will produce at locked rotor current (such as a full voltage start). Locked rotor torque is described as a percentage of full load torque.

**Mill, ball** – a machine which grinds or mixes materials such as ores, chemicals, ceramics and paints. The machine consists of a horizontal cylinder which is rotated, causing the grinding medium, commonly stainless steel balls, to repeatedly crush the material inside into a powder.

**Mill, hammer** – a machine which crushes material into smaller pieces. Hammers attached to rotating disks repeatedly strike the material until it is small enough to fall through openings at the bottom of the mill.

**Mill, roller** – a machine which crushes material into smaller pieces. Material is passed between two horizontal rollers which rotate in opposite directions, crushing the material into smaller pieces.

**Milliscreen** – a machine which separates solids from slurry, using an inclined rotating drum with perforated sides.

**Mixer** – a machine which combines ingredients.

**Nameplate rating** – See Full load current.

**NEMA** – a description of the soft starter's physical format, according to the National Electrical Manufacturers' Association standard.

**Pelletiser** – a machine which turns powders into pellets.

**Planer** – a machine which draws boards over a cutting head to reduce them to a specified thickness.

**Press** – a machine which changes the shape and internal structure of metals (usually steel).

**Pump** – a machine which moves fluids.

**Pump, bore** – a submersible pump with a small diameter, suitable for operation down bores.

**Pump, centrifugal** – a pump with an impeller which causes fluid to rotate and move from the inlet to the outlet under its own momentum. The fluid's velocity increases as it progresses through the impeller passage. Diffuser, ring or volute cavities reduce the velocity of the fluid and convert the energy into pressure energy.

**Pump, positive displacement** – a pump which reduces the volume of the pump chamber to cause the fluid to move. Positive displacement pumps may be used for viscous fluids, and include rotary (lobe, screw or gear pump) and reciprocating (piston or diaphragm pump) types.

**Pump, slurry** – a centrifugal pump for pumping slurry.

**Pump, submersible** – a pump which is submerged in the fluid to be pumped. The sealed motor is close-coupled to the pump body.

**Pump, vacuum** – a pump which removes gas from a sealed chamber in order to create a partial vacuum. Multiple vacuum pumps may be used together for a single application.

**Re-pulper** – a machine which re-pulps raw product for further processing.

**Rotary table** – a large rotating table which is used to sort or move material.

**Sander** – a machine which smooths raw material by abrading the surface.

**Saw** – a machine which uses a serrated edge to cut materials.

**Saw, band** – a saw where the cutting edge is a long, thin strip of metal with teeth on one side, commonly used for ripping lumber.

**Saw, circular** – a saw where the cutting edge is a large rotating disk with teeth on the outer edge.

**Screw feed** – see Auger.

**Separator** – a type of centrifuge.

**Shredder** – a machine that tears objects such as paper, plastic or wood into smaller pieces.

**Slabber** – a machine consisting of several saws, which cuts edged logs into smaller pieces before further processing.

**Slicer** – a machine that slices materials, normally using more than one blade.

**Travelator** – a type of conveyor which is used to move people along a flat or inclined surface.

**Tumbler** – a machine which rotates to turn material over during drying or other processes.

**Vibrating screen** – a machine which separates particles of different sizes by vibrating horizontally. Smaller particles fall through gaps in the plane.

**Winch** – a machine which winds ropes or cables.

**Wire draw machine** – a machine which draws metal wire through progressively narrower dies to create finer wire.

AC – Alternating Current

DC – Direct Current

DOL – Direct On Line

FLC – Full Load Current

FLT – Full Load Torque

HRC – High Rupturing Capacity

IP – International Protection

kW – Kilowatt

LRC – Locked Rotor Current

MCCB – Moulded Case Circuit Breaker

PFC – Power Factor Correction

SCR – Silicon Controlled Rectifier

TVR – Time Voltage Ramp

