

COMPACT
disc
DIGITAL AUDIO



For U.S.A.

As an ENERGY STAR® Partner, Panasonic has determined that this product meets the ENERGY STAR® guidelines for energy efficiency.

Before connecting, operating or adjusting this product, please read these instructions completely.
Please keep this manual for future reference.

SC-PM193 is available in the U.S.A only

Panasonic

CD Stereo System

Operating Instructions

Model No. **SC-PM19**
SC-PM193

Table of contents

Before use

Supplied accessories	3
IMPORTANT SAFETY INSTRUCTIONS ..	4
Product Service	4
Listening caution	4
The remote control	5
Placement of speakers	5
Connections	5
Front panel controls	7
Demo function	8
Setting the time	8
Convenient functions	8

Listening operations

The radio: manual tuning	9
The radio: preset tuning	10
CDs	11
Enjoying MP3	16
Cassette tapes	20

Recording operations

Before recording	21
Recording the radio	21
Recording CDs	22
Auto-off function	22

Timers and others

Using the timers	23
Using the sound quality settings	25
Enhancing the sound quality	25
Using an external unit	25

Reference

Troubleshooting guide	26
Warranty (ONLY FOR U.S.A.)	27
Customer Services Directory (ONLY FOR U.S.A.)	27
Specifications	Back cover
Maintenance	Back cover
When moving the unit	Back cover



P PC

RQT7364-P

Dear customer

Thank you for purchasing this product.
For optimum performance and safety, please read these instructions carefully.

These operating instructions are applicable to the following system.

System	SC-PM19	SC-PM193
Main unit	SA-PM19	SA-PM193
Speakers	SB-PM19	SB-PM193

The model number and serial number of this product can be found on either the back or the bottom of the unit. Please note them in the space provided below and keep for future reference.

MODEL NUMBER _____

SERIAL NUMBER _____

User memo:

DATE OF PURCHASE _____

DEALER NAME _____

DEALER ADDRESS _____

TELEPHONE NUMBER _____

WARNING:

TO REDUCE THE RISK OF FIRE, ELECTRIC SHOCK OR PRODUCT DAMAGE, DO NOT EXPOSE THIS APPARATUS TO RAIN, MOISTURE, DRIPPING OR SPLASHING AND THAT NO OBJECTS FILLED WITH LIQUIDS, SUCH AS VASES, SHALL BE PLACED ON THE APPARATUS.

Except for U.S.A.

CAUTION	- INVISIBLE LASER RADIATION WHEN OPEN. AVOID EXPOSURE TO BEAM. IEC60825-1 / Class 3b
VARNING	- OSYNLIG LASERSTRÅLNING NÄR DENNA DEL ÄR ÖPPNAD. BETRÄKTA EJ STRÅLEN.
ADVARSEL	- USYNLIG LASERSTRÅLING VED ÅBNING. UNDGÅ UDSÆTTELSE FOR STRÅLING.
ADVARSEL	- USYNLIG LASERSTRÅLING NÄR DEKSEL ÄPNES. UNNGÅ EKSPONERING FÖR STRÅLEN.
VARO!	- AVIATTAESSA OLET NÄKYMÄTÖNTÄ. ÄLTIIMÄ LASERSÄTELYLLE. ÄLÄ KATSO SÄTEESEEN.
VORSICHT	- UNSICHTBARE LASERSTRÄHLUNG. WENN ABDECKUNG GEÖFFNET, NICHT DEM STRAHL AUSSETZEN.
ATTENTION	- RAYONNEMENT LASER INVISIBLE EN CAS D'OUVERTURE. EXPOSITION DANGEREUSE AU FAISCEAU.
注意	- 打州時有不可見激光辐射。避免激光照射。
注意	- ここを開くと不可視レーザー光が出ます。ビームを見たり、触れたりしないで下さい。 RQLXS0058

Inside of product

THE FOLLOWING APPLIES ONLY IN THE U.S.A.

CAUTION:

This equipment has been tested and found to comply with the limits for a Class B digital device, pursuant to Part 15 of the FCC Rules.

These limits are designed to provide reasonable protection against harmful interference in a residential installation. This equipment generates, uses and can radiate radio frequency energy and, if not installed and used in accordance with the instructions, may cause harmful interference to radio communications. However, there is no guarantee that interference will not occur in a particular installation. If this equipment does cause harmful interference to radio or television reception, which can be determined by turning the equipment off and on, the user is encouraged to try to correct the interference by one or more of the following measures:

- Reorient or relocate the receiving antenna.
- Increase the separation between the equipment and receiver.
- Connect the equipment into an outlet on a circuit different from that to which the receiver is connected.
- Consult the dealer or an experienced radio/TV technician for help.

Any unauthorized changes or modifications to this equipment would void the user's authority to operate this device.

This device complies with Part 15 of the FCC Rules. Operation is subject to the following two conditions: (1) This device may not cause harmful interference, and (2) this device must accept any interference received, including interference that may cause undesired operation.



CAUTION: TO REDUCE THE RISK OF ELECTRIC SHOCK, DO NOT REMOVE SCREWS. NO USER-SERVICEABLE PARTS INSIDE. REFER SERVICING TO QUALIFIED SERVICE PERSONNEL.



The lightning flash with arrowhead symbol, within an equilateral triangle, is intended to alert the user to the presence of uninsulated "dangerous voltage" within the product's enclosure that may be of sufficient magnitude to constitute a risk of electric shock to persons.



The exclamation point within an equilateral triangle is intended to alert the user to the presence of important operating and maintenance (servicing) instructions in the literature accompanying the appliance.

CAUTION!

THIS PRODUCT UTILIZES A LASER.
USE OF CONTROLS OR ADJUSTMENTS OR
PERFORMANCE OF PROCEDURES OTHER THAN
THOSE SPECIFIED HEREIN MAY RESULT IN
HAZARDOUS RADIATION EXPOSURE.
DO NOT OPEN COVERS AND DO NOT REPAIR
YOURSELF. REFER SERVICING TO QUALIFIED
PERSONNEL.

CAUTION!

DO NOT INSTALL OR PLACE THIS UNIT IN A
BOOKCASE, BUILT-IN CABINET OR IN ANOTHER
CONFINED SPACE. ENSURE THE UNIT IS WELL
VENTILATED. TO PREVENT RISK OF ELECTRIC
SHOCK OR FIRE HAZARD DUE TO OVERHEATING,
ENSURE THAT CURTAINS AND ANY OTHER
MATERIALS DO NOT OBSTRUCT THE VENTILATION
VENTS.

Supplied accessories

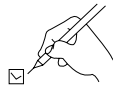

Please check and identify the supplied accessories.

Use numbers indicated in parentheses when asking for replacement parts.

In U.S.A. to order accessories, refer to "Accessory Purchases" on page 27.

- AC power supply cord 1 pc.
(K2CB2CB00006)

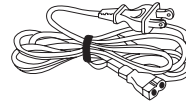

- FM indoor antenna 1 pc.
(RSA0007-L)

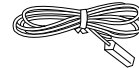

- AM loop antenna 1 pc.
(N1DAAAA00001)



- Remote control transmitter 1 pc.
(EUR7711150)

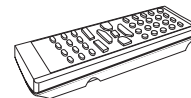

- Remote control batteries 2 pcs.
R6, AA, UM-3



IMPORTANT SAFETY INSTRUCTIONS

Read these operating instructions carefully before using the unit. Follow the safety instructions on the unit and the applicable safety instructions listed below. Keep these operating instructions handy for future reference.

- 1) Read these instructions.
- 2) Keep these instructions.
- 3) Heed all warnings.
- 4) Follow all instructions.
- 5) Do not use this apparatus near water.
- 6) Clean only with dry cloth.
- 7) Do not block any ventilation openings. Install in accordance with the manufacturer's instructions.
- 8) Do not install near any heat sources such as radiators, heat registers, stoves, or other apparatus (including amplifiers) that produce heat.
- 9) Do not defeat the safety purpose of the polarized or grounding-type plug. A polarized plug has two blades with one wider than the other. A grounding-type plug has two blades and a third grounding prong. The wide blade or the third prong are provided for your safety. If the provided plug does not fit into your outlet, consult an electrician for replacement of the obsolete outlet.

- 10) Protect the power cord from being walked on or pinched particularly at plugs, convenience receptacles, and the point where they exit from the apparatus.
- 11) Only use attachments/accessories specified by the manufacturer.
- 12) Use only with the cart, stand, tripod, bracket, or table specified by the manufacturer, or sold with the apparatus. When a cart is used, use caution when moving the cart/apparatus combination to avoid injury from tip-over.
- 13) Unplug this apparatus during lightning storms or when unused for long periods of time.
- 14) Refer all servicing to qualified service personnel. Servicing is required when the apparatus has been damaged in any way, such as power-supply cord or plug is damaged, liquid has been spilled or objects have fallen into the apparatus, the apparatus has been exposed to rain or moisture, does not operate normally, or has been dropped.



Before use

Product Service

1. **Damage requiring service**—The unit should be serviced by qualified service personnel if:
 - (a) The AC power supply cord or AC adaptor has been damaged; or
 - (b) Objects or liquids have gotten into the unit; or
 - (c) The unit has been exposed to rain; or
 - (d) The unit does not operate normally or exhibits a marked change in performance; or
 - (e) The unit has been dropped or the cabinet damaged.
2. **Servicing**—Do not attempt to service the unit beyond that described in these operating instructions. Refer all other servicing to authorized servicing personnel.
3. **Replacement parts**—When parts need replacing ensure the servicer uses parts specified by the manufacturer or parts that have the same characteristics as the original parts. Unauthorized substitutes may result in fire, electric shock, or other hazards.
4. **Safety check**—After repairs or service, ask the servicer to perform safety checks to confirm that the unit is in proper working condition.

Product information

For product information or assistance with product operation: In the U.S.A., refer to "Customer Services Directory" below. For assistance in the continental U.S.A. in obtaining repairs please ship the product to:

Panasonic Services Company - Customer Servicer
Suite B 4900 George McVay Drive
McAllen, TX 78503

In Puerto Rico contact the Panasonic Sales Company.
Tel. (787) 750-4300 Fax. (787) 768-2910

When shipping the unit carefully pack and send it prepaid, adequately insured and preferably in the original carton. Include a letter detailing the complaint and provide a day time phone number where you can be reached.

IF REPAIR IS NEEDED DURING THE WARRANTY PERIOD THE PURCHASER WILL BE REQUIRED TO FURNISH A SALES RECEIPT/PROOF OF PURCHASE INDICATING DATE OF PURCHASE, AMOUNT PAID AND PLACE OF PURCHASE. CUSTOMER WILL BE CHARGED FOR THE REPAIR OF ANY UNIT RECEIVED WITHOUT SUCH PROOF OF PURCHASE.

Also, the purchaser will be responsible for shipping the unit to the above address.

In Canada, contact the Panasonic Canada Inc. Customer Care Centre at 905-624-5505, or visit the website (www.panasonic.ca), or an authorized Servicer closest to you.

Listening caution



Selecting fine audio equipment such as the unit you've just purchased is only the start of your musical enjoyment. Now it's time to consider how you can maximize the fun and excitement your equipment offers. This manufacturer and the Electronic Industries Association's Consumer Electronics Group want you to get the most out of your equipment by playing it at a safe level. One that lets the sound come through loud and clear without annoying blaring or distortion—and, most importantly, without affecting your sensitive hearing.

We recommend that you avoid prolonged exposure to excessive noise.

Sound can be deceiving. Over time your hearing "comfort level" adapts to higher volumes of sound. So what sounds "normal" can actually be loud and harmful to your hearing. Guard against this by setting your equipment at a safe level BEFORE your hearing adapts.

To establish a safe level:

- Start your volume control at a low setting.
- Slowly increase the sound until you can hear it comfortably and clearly, and without distortion.

Once you have established a comfortable sound level:

- Set the dial and leave it there.

Taking a minute to do this now will help to prevent hearing damage or loss in the future. After all, we want you listening for a lifetime.

A

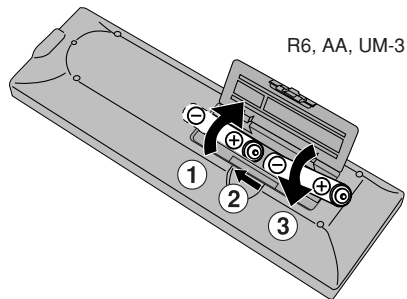

B

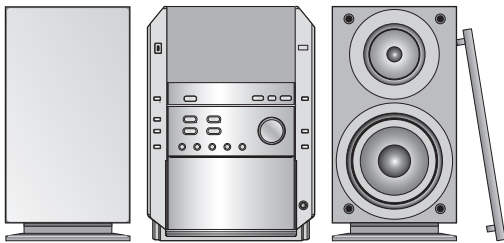

C

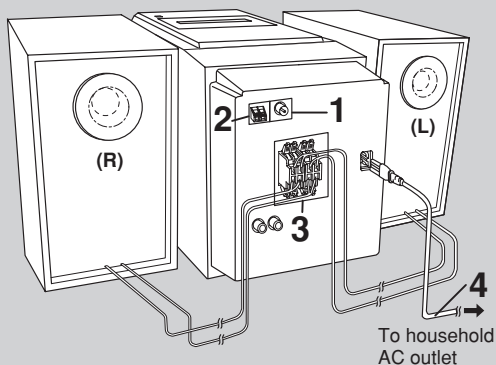

1

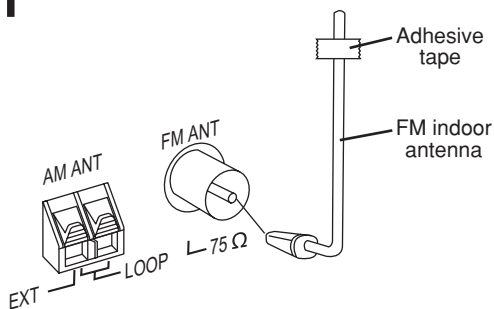

A The remote control

■ Batteries

- Insert so the poles (+ and -) match those in the remote control.
- Do not use rechargeable type batteries.

Do not:

- mix old and new batteries.
- use different types at the same time.
- heat or expose to flame.
- take apart or short circuit.
- attempt to recharge alkaline or manganese batteries.
- use batteries if the covering has been peeled off.

Mishandling of batteries can cause electrolyte leakage which can damage items the fluid contacts and may cause a fire.

Remove if the remote control is not going to be used for a long period of time. Store in a cool, dark place.

■ Use

Aim at the remote control sensor, avoiding obstacles, at a maximum range of 7 m (23 feet) directly in front of the unit. Refer to page 7 for the remote control sensor position.

B Placement of speakers

Speakers are designed identically so that no left or right channel orientation is necessary.

Notes

- Keep your speakers at least 10 mm ($13/32$ "") away from the system for proper ventilation.
- These speakers do not have magnetic shielding. Do not place them near televisions, personal computers or other devices easily influenced by magnetism.
- To avoid damage to the speakers, do not touch the speaker cones if you have taken the nets off.

C Connections

- Plug the AC power supply cord into a household AC outlet only after all other connections have been made.
- To prepare the AM loop antenna wire and speaker cords, twist the vinyl cover tip and pull off.

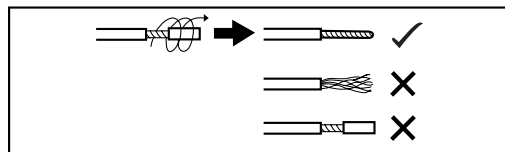

1 Connect the FM indoor antenna.

Tape the antenna to a wall or column, in a position where radio signals are received with the least amount of interference.

Note

For the best reception:

An FM outdoor antenna is recommended. (→ page 6)

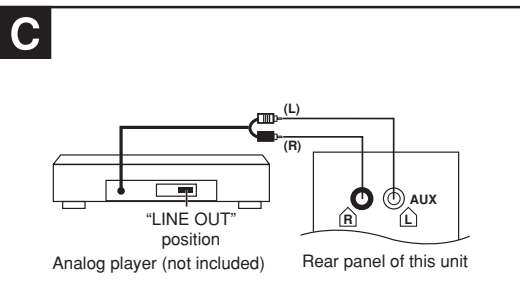
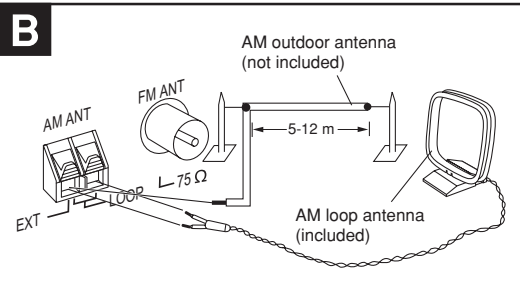
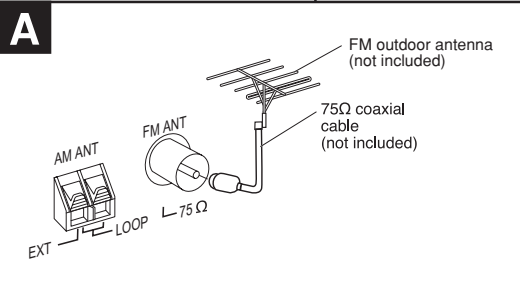
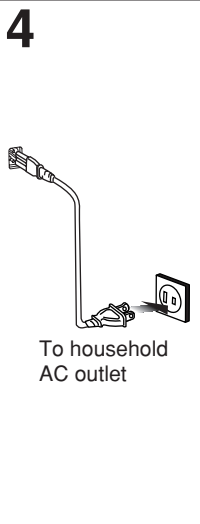
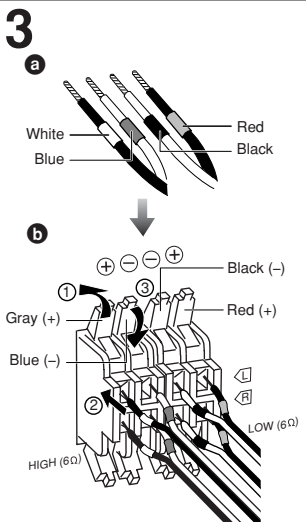
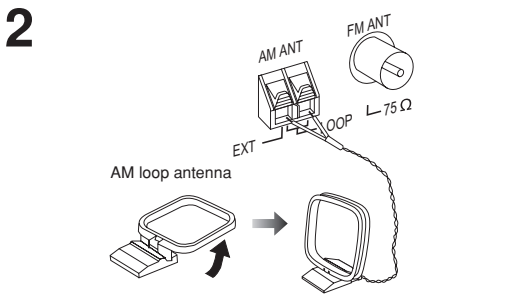

Connections

2 Connect the AM loop antenna.

Stand the antenna up on its base. Keep loose antenna cord away from other wires and cords.

3 Connect the speaker cords.

- a** Confirm the colors of the tags on the ends of the cords.
 - b** For White tags:
Connect cords to gray terminals.
For Blue, Black and Red tags:
Connect cords so tag colors match the terminal colors.
Cords with white and blue tags are for high frequency.
Cords with red and black tags are for low frequency.
- Incorrect connection can damage the unit.**

Caution

Use only the supplied speakers.

The combination of the main unit and speakers provide the best sound. Using other speakers can damage the unit and sound quality will be negatively affected.

Caution

- Use the speakers only with the recommended system. Failure to do so may lead to damage to the amplifier and/or the speakers, and may result in the risk of fire. Consult a qualified service person if damage has occurred or if you experience a sudden change in performance.
- Do not attach these speakers to walls or ceilings.

4 Connect the AC power supply cord.

Note

The included AC power supply cord is for use with this unit only. Do not use it with other equipment.

Optional antenna connections

You may need an outdoor antenna if you use this system in a mountainous region or inside a reinforced-concrete building, etc.

A FM outdoor antenna

Disconnect the FM indoor antenna if an FM outdoor antenna is installed.

Note

An outdoor antenna should be installed by a qualified technician only.

B AM outdoor antenna

Connect the outdoor antenna without removing the AM loop antenna. Run 5 to 12 m of vinyl-covered wire horizontally along a window or other convenient location.

Note

When the unit is not in use, disconnect the outdoor antenna to prevent possible damage that may be caused by lightning. Never use an outdoor antenna during a lightning storm.

External unit connections

- Make sure that the power supply for all components has been turned off before making any connections.
- For details, refer to the operating instructions of the unit which is to be connected.
- All peripheral components and cables sold separately.

C Connecting analog equipment

This example shows how to connect an analog player with a PHONO OUT/LINE OUT switch. When units other than those described are to be connected, please consult your audio dealer.

Note

- Only an analog player with a built-in phono equalizer can be connected.
- Set the switch to the "LINE OUT" position at the back of the analog player.

Top of the unit

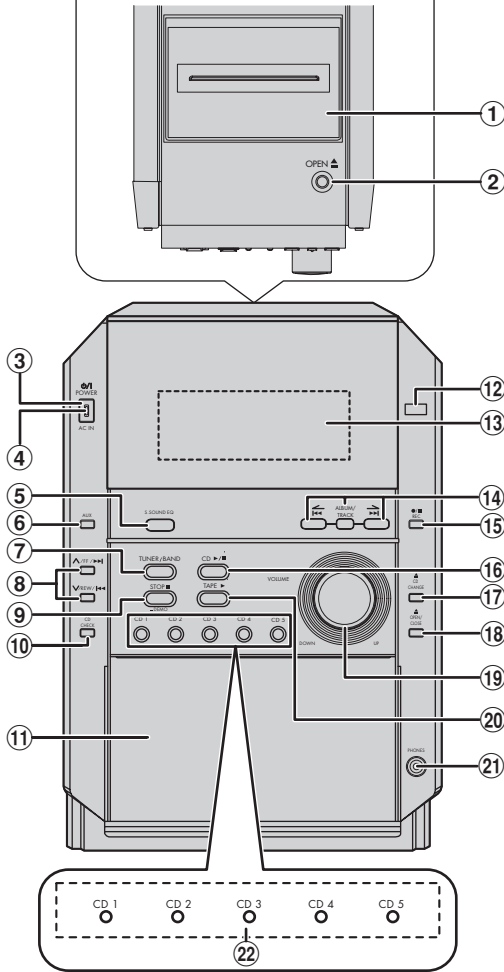

Front panel controls

Main unit

- ① **Cassette lid**
- ② **Cassette open button (OPEN ▲)** 20
- ③ **Standby/on switch (⏻/ I POWER)** 8
Press to switch the unit from on to standby mode or vice versa. In standby mode, the unit is still consuming a small amount of power.
- ④ **AC supply indicator (AC IN)**
This indicator lights when the unit is connected to the AC outlet.
- ⑤ **Super sound EQ button (S.SOUND EQ)** 25
- ⑥ **Aux button (AUX)** 25
- ⑦ **Tuner/band select button (TUNER/BAND)** 9
- ⑧ **CD skip/search, tape fast-forward/rewind/TPS, tune/preset channel select, time adjust buttons (√/REW/⏪, ⏩/FF/▶▶)** 9, 11, 20, 23
- ⑨ **Stop and demonstration button (STOP ■, -DEMO)** 8, 11
- ⑩ **Checking CD position (CD CHECK)** 12
- ⑪ **CD trays**
- ⑫ **Remote control sensor**
- ⑬ **Display**
- ⑭ **Album/track selection button (⏪ ALBUM/TRACK ⏩)** 16
- ⑮ **Recording start/pause button (●/|| REC)** 21
- ⑯ **CD play/pause button (CD ▶/||)** 11
- ⑰ **CD change button (▲ CD CHANGE)** 12
- ⑱ **CD tray open/close button (▲ OPEN/CLOSE)** 11
- ⑲ **Volume control (VOLUME DOWN, UP)** 9
- ⑳ **Tape play button (TAPE ▶)** 20
- ㉑ **Headphone jack (PHONES)** 25
- ㉒ **CD selection (CD 1~CD 5)** 12

Remote Control

- Buttons such as ③ function in exactly the same way as the buttons on the main unit.
- ㉓ **Auto off/Sleep timer button (AUTO OFF, SLEEP)** 22, 24
 - ㉔ **Disc button (DISC)** 13
 - ㉕ **CD Program, tuner preset button (PROGRAM)** 10, 15
 - ㉖ **Play mode select button (PLAY MODE)** 9, 13
Use this for selecting CD play mode, tune mode and FM mode.
 - ㉗ **Repeat button (REPEAT)** 14
 - ㉘ **Delete button (DEL)** 18
 - ㉙ **Album selection button (ALBUM, ⏪ ⏩)** 16
 - ㉚ **Intro button (INTRO)** 17
 - ㉛ **Marker memory/recall button (MARKER)** 19
 - ㉜ **Shift button (SHIFT)**
To use functions labelled in orange ✱:
While pressing [SHIFT], press the corresponding button.
 - ✱ For buttons [AUTO OFF], [CLOCK/TIMER], [⊙PLAY/REC] and [SURROUND].
 - ㉝ **Surround, Super sound EQ button (SURROUND, S.SOUND EQ)** 25
 - ㉞ **Play timer/record timer/Dimmer button (⊙PLAY/REC, DIMMER)** 8, 23
 - ㉟ **Clock/timer/CD display button (CLOCK/TIMER, DISPLAY)** 8, 14
 - ㊱ **Numbered, character buttons (≥10, 1-9, 0, A-Z, SPACE!#)** 10, 18
 - ㊲ **Stop/clear button (■ CLEAR)** 15
 - ㊳ **Enter button (ENTER)** 18
 - ㊴ **Title search mode select button (TITLE SEARCH)** 18
 - ㊵ **Muting button (MUTING)** 8
 - ㊶ **Preset EQ/Manual EQ button (SOUND)** 25

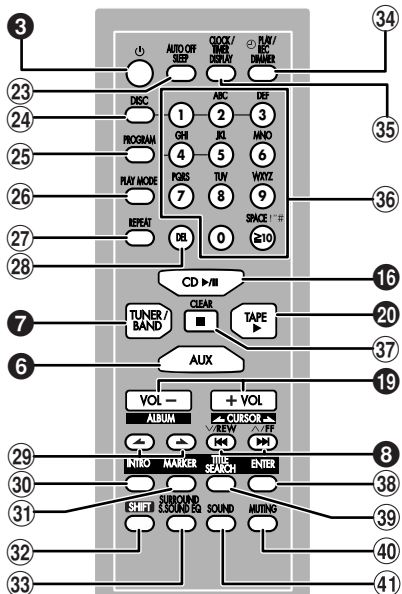

A

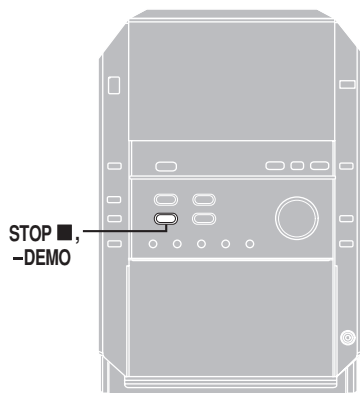

B

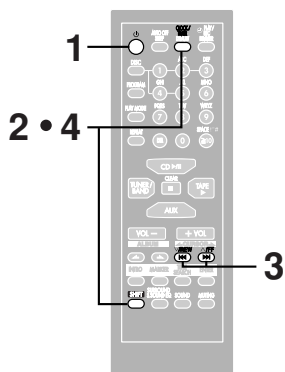

1



2

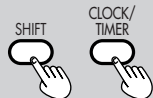

3

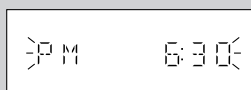
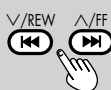

4

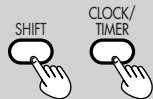

C

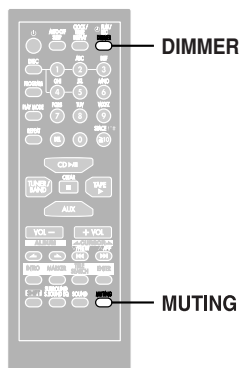

A Demo function

When the unit is first plugged in, a demonstration of its functions may be shown on the display. If the demo setting is off, you can show a demonstration by selecting "DEMO ON".

Press and hold [STOP ■, -DEMO].

The display changes each time the button is held down.

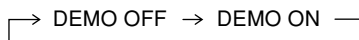

While in the standby mode, select "DEMO OFF" to reduce power consumption.

B Setting the time

This is a 12-hour clock.

1 Press [⏻] to turn the unit on.

2 Press [SHIFT] + [CLOCK/TIMER] to display "CLOCK".

Every time you press the button:

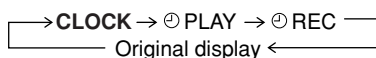

3 Within 5 seconds

Press and hold [V/REW/◀] or [^/FF/▶] to set the time.

4 Press [SHIFT] + [CLOCK/TIMER].

Displaying the clock:

Press [SHIFT] + [CLOCK/TIMER].

The clock is shown for about 5 seconds.

Note

The clock may lose or gain some time over a period. Readjust if necessary.

C Convenient functions

To dim the display panel

Press [DIMMER].

The display brightness will be reduced except for [AC IN] indicator.

To cancel, press [DIMMER] again.

To mute the volume

Press [MUTING].

To cancel, press [MUTING] again.

Muting can also be cancelled by lowering the volume all the way to "--dB".

When the system is turned off, the muting operation will be automatically cancelled.

The radio: manual tuning

1 Press [TUNER/BAND] to select:

→ FM → AM

2 Press [PLAY MODE] to select "MANUAL".

→ PRESET → MANUAL

3 Press [V/REW/◀◀] or [V/FF/▶▶] to select the frequency of the required station.

"ST" is displayed when a stereo FM broadcast is being received.

4 Adjust the volume.

Auto tuning

Press and hold [V/REW/◀◀] or [V/FF/▶▶] for a moment. The unit begins auto tuning when the frequency starts changing rapidly and stopping when it finds a station.

- To cancel, press [V/REW/◀◀] or [V/FF/▶▶] again.
- Excessive interference may interrupt auto tuning.

A To improve FM sound quality

Press and hold [PLAY MODE] to display "MONO".

To cancel, press and hold [PLAY MODE] again.

MONO is also cancelled if the frequency is changed. For normal listening, turn off "MONO".

B FM allocation setting

By main unit only

This system allows you to receive FM broadcasts allocated in 0.1 MHz steps.

To change the step to 0.1 MHz

- ① Press and hold [TUNER/BAND].
After a while the display flashes with the current minimum frequency.
- ② Continue to hold [TUNER/BAND] down.
When the minimum frequency changes, release the button.
To cancel, repeat the above steps.

Notes

- After changing the setting, previously preset frequency will be cleared.
- Sound is momentarily interrupted if you load/unload a cassette while listening to an AM broadcast.

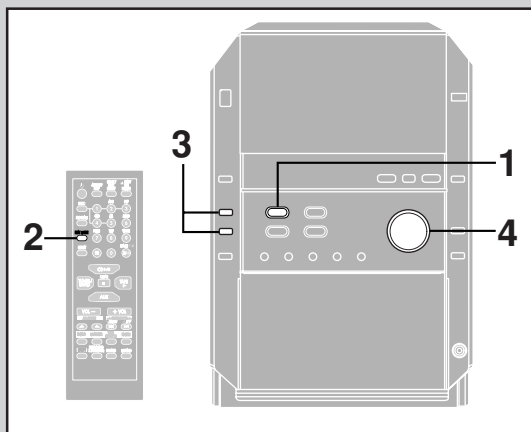

1 TUNER/BAND



2 PLAY MODE



3 V/FF/▶▶
V/REW/◀◀



4 VOLUME

DOWN UP

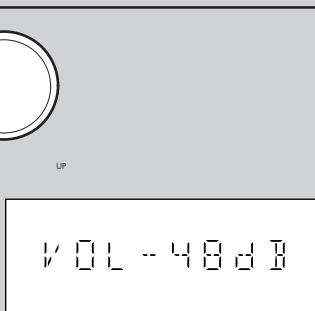

A PLAY MODE



B TUNER/BAND

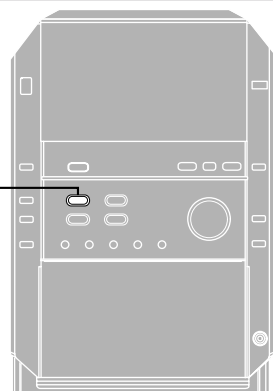

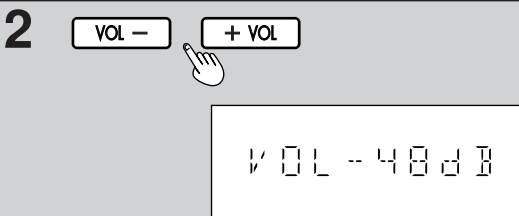
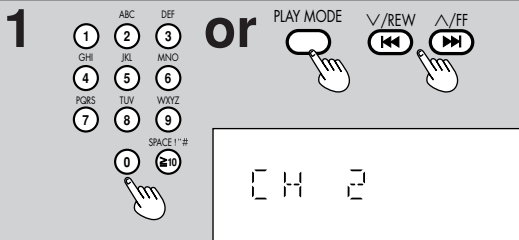
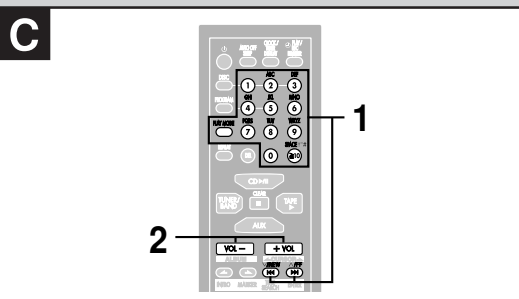
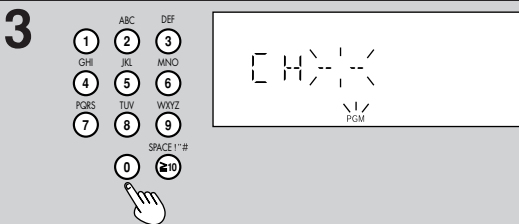
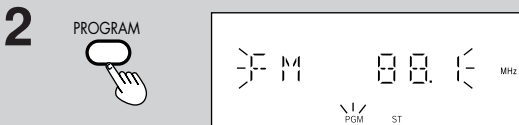
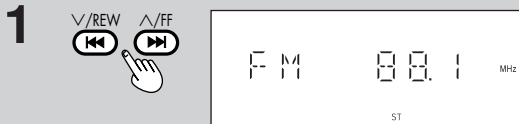
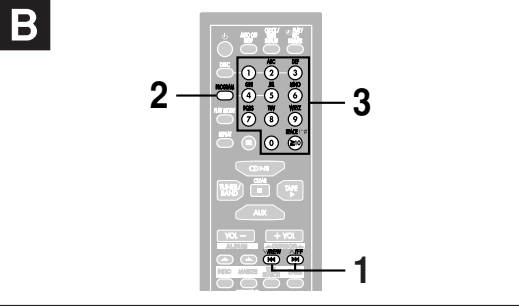
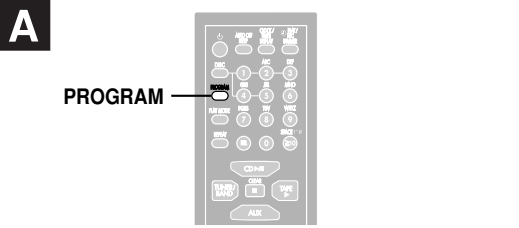

The radio: preset tuning

There are two methods of pre-setting stations:

Automatic presetting: Stations the tuner can receive are preset automatically.

Manual presetting: You can select the stations to preset and the order they are preset in.

Up to 15 stations can be preset for FM and AM bands. Press [TUNER/BAND] to select "FM" or "AM".

A Automatic presetting

Auto presetting for AM and FM each.

1 Tune to the frequency where presetting is to begin (⇒ page 9).

2 Press and hold [PROGRAM]. Auto presetting starts and the last station memorized is tuned in.

B Manual presetting

Preset the stations one at a time.

1 Press [V/REW/◀◀] or [^/FF/▶▶] to tune to the required station.

2 Press [PROGRAM].

3 Press numeric buttons to select a channel. The station occupying a channel is erased if another station is preset in that channel.

C Selecting channels

1 Press numeric buttons to select the channel. For channels 10 to 15 press [≥10], then the two digits.

OR

① Press [PLAY MODE] to select "PRESET".

② Press [V/REW/◀◀] or [^/FF/▶▶] to select the channel.

2 Adjust the volume.

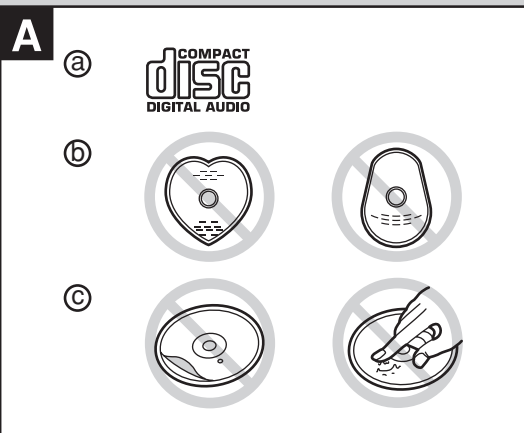
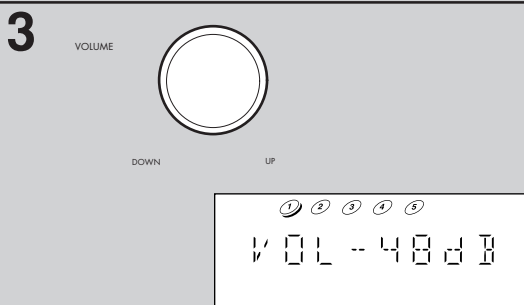
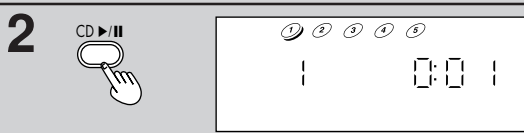
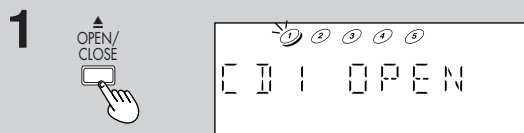
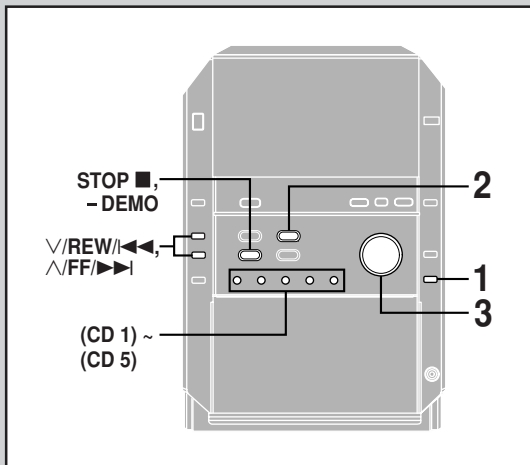

CDs

This unit can play CD-DA (digital audio) format audio CD-R and CD-RW that have been finalized (a process performed after recording that enables this unit to play audio CD-R and CD-RW).

It may not be able to play some CD-R or CD-RW due to the condition of the recording.

The unit contains five CD trays.

You can simply listen to the CD on a single tray, or you can select and listen to the CD in a particular tray. See the section on All-Disc play (→ page 13) for information on how to listen to all the CDs one after another.

Listening to CD on a single tray

- 1** Press [▲ OPEN/CLOSE] to insert the CD on the disc tray. Press again to close.
- 2** Press [CD ►/||] to start play from the first track. The player stops after playing the last track.
- 3** Adjust the volume.

To	Action
stop the disc	Press [STOP ■ , -DEMO].
pause play	Press [CD ►/]. Press again to resume play.
skip tracks	Press [V/REW/◀◀] or [▲/FF/▶▶].
search through tracks	Press and hold [V/REW/◀◀] or [▲/FF/▶▶] during play or pause.
view CD indicator	The CD indicator on the display lights whenever the tray is in the playing position.
start one touch play	If the unit is in standby mode and a CD is loaded, press [CD ►/] or [CD 1] ~ [CD 5]. The unit will come on automatically and play will start.

A CD selection and care

Only play CDs with COMPACT disc DIGITAL AUDIO trademark. (see (a))

Do not;

- Use irregularly shaped CDs. ((b))
- Attach extra labels and stickers.
- Use discs with labels and stickers that are coming off or with adhesive exuding from under labels and stickers. ((c))
- Attach scratch-proof covers or any other kind of accessory.
- Write anything on the CD.
- Clean CDs with liquids. (Wipe with a soft, dry cloth.)
- Use CDs printed with label printer available on the market.

To prevent damage

Always observe the following points.

- Set the system on a flat, level surface.
Do not set it on top of magazines, inclined surfaces, etc.
- Do not move the system while tray is opening/closing, or when loaded. Always unload all CDs before moving the system.
- Do not put anything except a CD in the tray.
- Do not use cleaning CDs or CDs which are badly warped or cracked.
- Do not disconnect the AC power cord from the household AC outlet during CD changing operation.

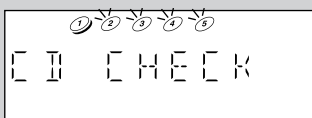
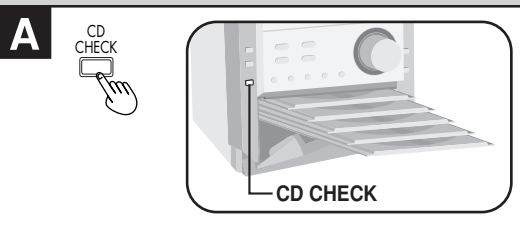
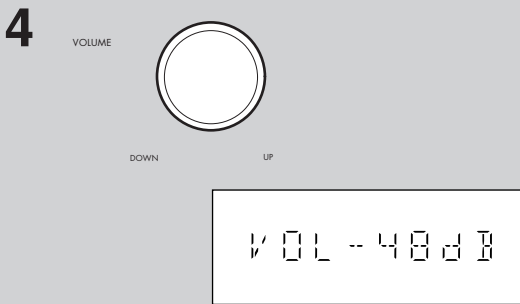
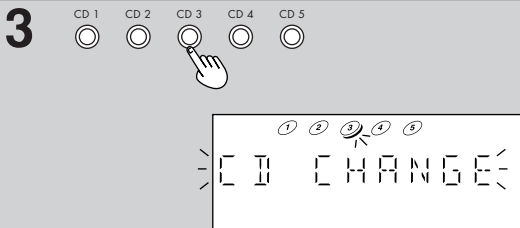
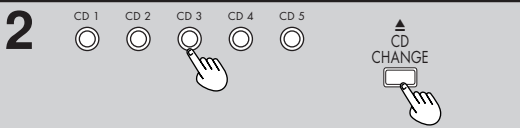
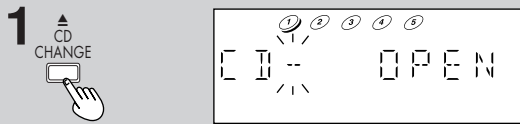
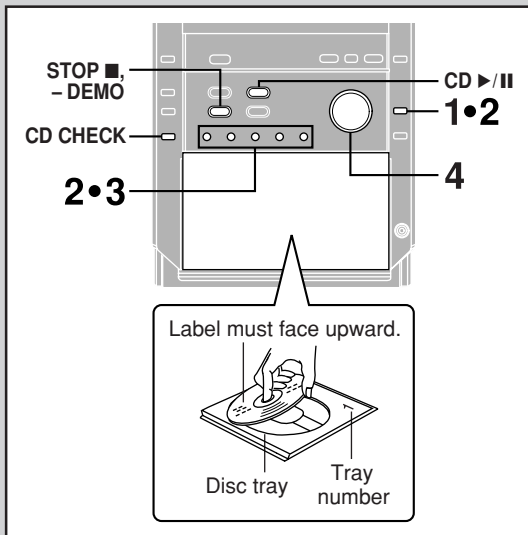

CDs

Listening to a CD placed in a specific tray

Preparation:

Press [CD ►/II] and then [STOP ■, -DEMO].

Placing a CD in your desired tray

- 1** Press [**▲** CD CHANGE].
- 2** (Within about 10 seconds)
Press [CD 1] ~ [CD 5] and insert the CD on the tray.
Press [**▲** CD CHANGE] again to close.
Repeat steps 1 and 2 to insert up to 5 CDs.

Listening to the CD placed in a specific tray

- 3** Press [CD 1] ~ [CD 5] to start play.
The player stops after playing the last track.
- 4** Adjust the volume.

To remove the CD

You can change the CDs in the other trays while one CD is playing (except in All-Disc Random play or program play).

- ① Press [**▲** CD CHANGE].
- ② Press [CD 1] ~ [CD 5].

Press [**▲** CD CHANGE] again to close the tray.

A To check which CDs are in the trays (CD CHECK)

Press [CD CHECK].

The tray with a CD being played will not open.
If the player is stopped, all trays will open.

Press [CD CHECK] again to close the trays.

- Do not remove or insert CDs during a CD check.
- Do not pull out the trays during a CD check.
- 8 cm (3³/₂₀") CDs cannot be checked.

Marking a track

You can mark one track each on the 5 discs loaded so that you can start play from them later. (➔ page 19)

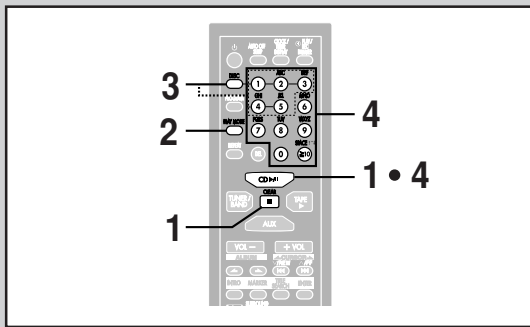

1 →

20 68:43

2

1-DISC

ALL-DISC

1-TRACK

1-RANDOM

A-RANDOM

3

1 2 3
4 5

CD CHANGE

4 or

CDs

Listening to specific CDs and tracks (CD Play Mode function)

Mode	To play
1-DISC	one selected disc.
ALL-DISC	all loaded discs in succession from the selected disc to the final disc *.
1-TRACK	one selected track on the selected disc.
1-RANDOM	one selected disc in random order.
A-RANDOM	all loaded discs in random order.

1 Press [CD ►/||] and then [■ CLEAR].

2 Press [PLAY MODE] to select your desired mode.

→ 1-DISC → ALL-DISC → 1-TRACK
← A-RANDOM ← 1-RANDOM ←

If A-RANDOM was selected in this step, press the play button.

3 Press [DISC] and (within 10 seconds) press [1]-[5] to select the disc.

The CD starts if 1-DISC, ALL-DISC or 1-RANDOM was selected in step 2.

4 • When 1-TRACK is selected in step 2
Select the track with the numeric buttons to start play.

To select track 10 or over, press [≥10] then the two digits.

• When 1-RANDOM or A-RANDOM is selected in step 2

Press [CD ►/||] to play CD.

When playback ends

The current play mode will be retained.

* Final disc

For example, if play starts from disc 4, disc 3 will be the "final disc".

Order of progression:

Disc 4→5→1→2→3

Notes

- You can use the CD Play Mode function together with repeat play.
- During 1-RANDOM play or A-RANDOM play, you cannot skip to tracks which have already been played.
- During 1-RANDOM play or A-RANDOM play, you can search forward or backward only within the current track.

A

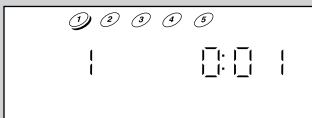
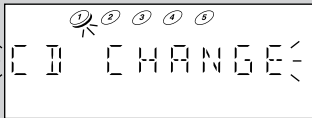
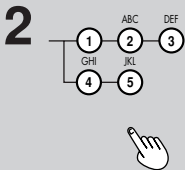
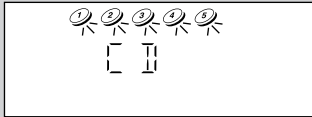
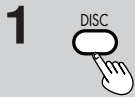
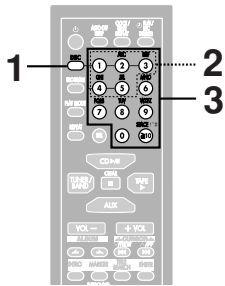

B

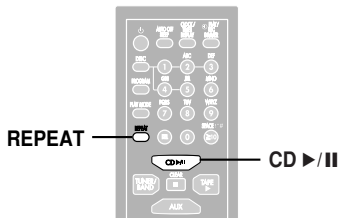

C

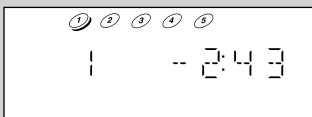
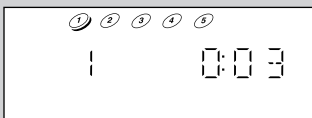
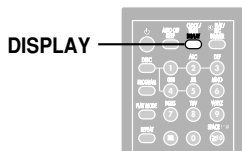

CDs

A Direct access play

Direct access allows you to start normal play from a specific track to the last track on the CD.

- 1** Press [DISC].
- 2** (Within 10 seconds or so)
Press [1] ~ [5] to select the disc you want.
- 3** Press the numeric button(s) to select and play your desired track number.

To select a two-digit track

Press [≧10] and then the two numbers you want.

Note

You cannot use direct access play with 1-RANDOM or A-RANDOM mode.

B Repeat play

Press [REPEAT] before or during play.

"REPEAT ON" and "Ⓜ" are displayed.

To cancel repeat play

Press [REPEAT] once again. "REPEAT OFF" is displayed and "Ⓜ" is cleared.

To repeat your favorite tracks

1. Program the tracks you want (perform steps 1 ~ 6 on page 15.)
2. Press [REPEAT] and make sure "REPEAT ON" and "Ⓜ" are displayed.
3. Press [CD ▶/II]. Playback will start.

To use repeat play with CD Play Mode function

Set the desired mode, press [REPEAT] before or during playback, and make sure "REPEAT ON" and "Ⓜ" are displayed.

C CD display

This function allows you to display the remaining play time of the current track.

During play or pause mode

Press [DISPLAY] to display:

→ Elapsed play time → Remaining play time →

Note

When track number 25 or greater is playing, remaining play time display shows "--:--".

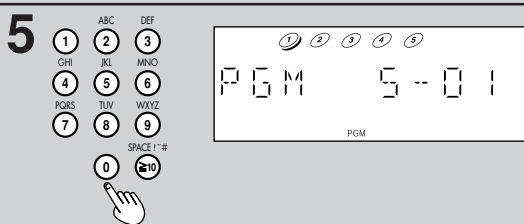
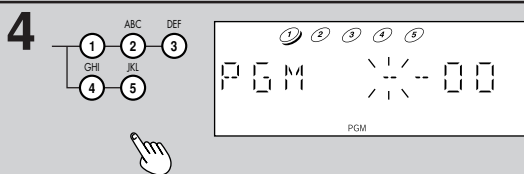
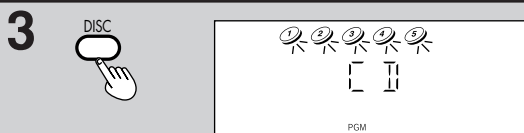
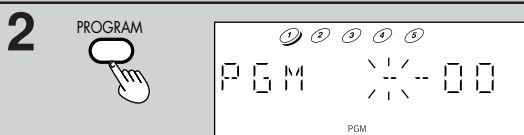
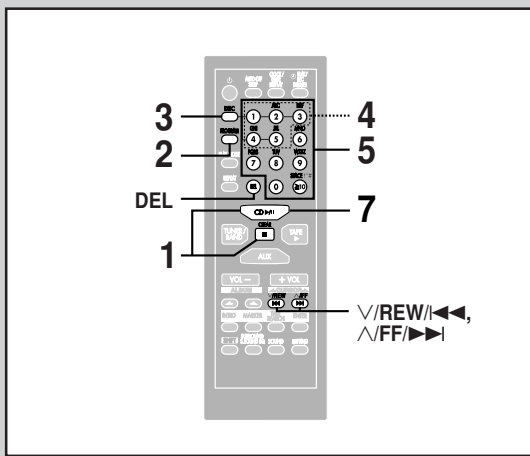

6 Repeat steps 3, 4, 5.



CDs

Program play

This function allows you to program up to 24 tracks.

- 1** Press [CD >||] and then [■ CLEAR].
- 2** Press [PROGRAM].
- 3** Press [DISC].
- 4** (within 10 seconds or so)
Press [1] – [5] to select the disc you want.
- 5** Press the numeric button(s) to select the desired track.
- 6** Repeat steps 3 through 5 to program other tracks.
- 7** Press [CD >||] to start play.

To	Action
cancel program play mode	Press [PROGRAM] in the stop mode. Programmed contents will be saved in memory.
clear the last track	Press [DEL] in the stop mode.
clear all programmed tracks	Press [■ CLEAR]. Within 5 seconds, press the button again to clear all tracks. "CLEAR ALL" is displayed.
select a two-digit track	Press [≥10] and then the two numbers you want.

When "CD FULL" appears

The number of programmed tracks is limited to 24 only.

You can do the following during program mode:

Check program contents on the display.
Press [V/REW/FF] or [V/FF/FF].

Add to the program.

Repeat steps 3 through 5 in the stop mode.

Memory retention

Your program is retained in memory for about 1 week while the system is unplugged.

To replay your program

If you turned OFF your program with [PROGRAM], you can play it again as explained below.

1. Press [PROGRAM].
2. Press [CD >||].

Notes

- During program play, you can search forward or backward only within the current track.
- During program play, skipping is always in the programmed order, whether forward or backward.
- You can use repeat mode with program play.
- You cannot program CD-DA together with MP3 tracks.

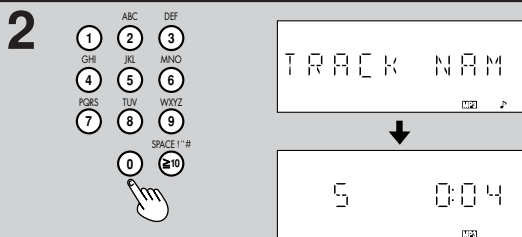
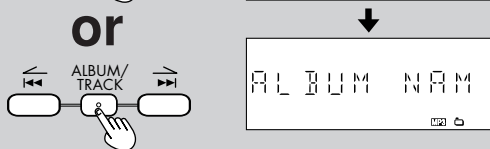
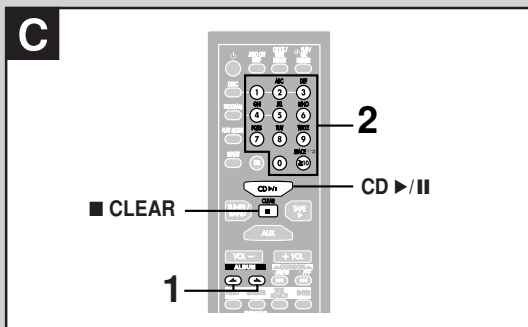
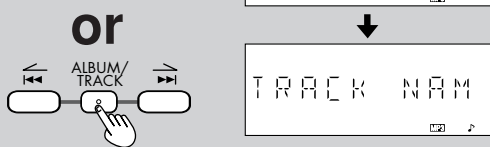
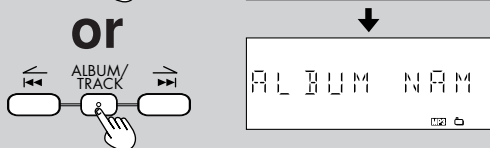
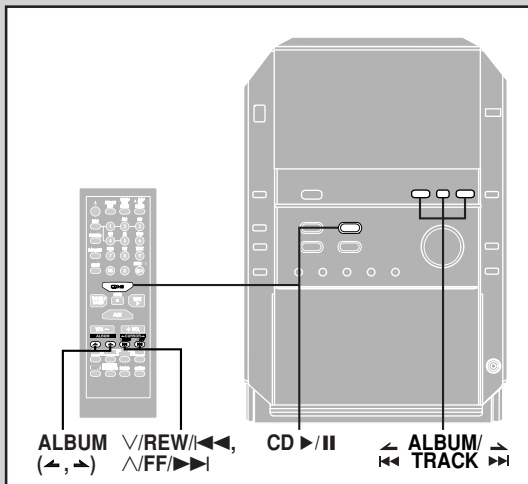

Enjoying MP3

This unit allows you to play MP3 files and access up to 999 tracks (files), 255 albums (folders) and 20 sessions.

When making MP3 files to play on this unit

Disc format

Discs must conform to ISO9660 level 1 or 2 (except for extended formats).

File format

- MP3 files must have the extension “.MP3” or “.mp3”.

To play in a certain order

Prefix the folder and file names with 3-digits numbers in the order you want to play them.

MPEG Layer-3 audio decoding technology licensed from Fraunhofer IIS and Thomsom multimedia.

Limitations on MP3 play

- This unit is not compatible with packet-write format.
- You cannot use 1-Disc Random play, All-Disc Random play and search function.
- Some MP3 may not be played due to the condition of the disc or recording.
- Recordings will not necessarily be played in the order you recorded them.

Display when in the stop mode

“MP3” : Indicates the disc contains MP3 files

A Album skip play

During play or stop

Press [ALBUM (← or →)] to select the desired album.

You can also press the center button of [ALBUM/TRACK], followed by [← or →] on the main unit to select an album.

When selecting in the stop mode:

Press [CD ▶/||] to start play.

B Track skip play

During play or stop

Press [V/REW/FF] or [V/FF/FF] to select a desired track.

You can also press the center button of [ALBUM/TRACK], followed by [← or →] on the main unit to select a track.

When selecting in the stop mode:

Press [CD ▶/||] to start play.

Note

During 1-ALBUM mode, track skipping can only be done within the current album.

C Starting play from a desired track in a desired album

Preparation: Press [CD ▶/||] and then [CLEAR].

1 Press [ALBUM (← or →)] to select the album.

You can also press the center button of [ALBUM/TRACK], followed by [← or →] on the main unit to select an album.

2 Press the numeric buttons to select your desired track in the current album.

For two digit numbers, press [≥10] once then the two digits. For three digit numbers, press [≥10] twice then the three digits.

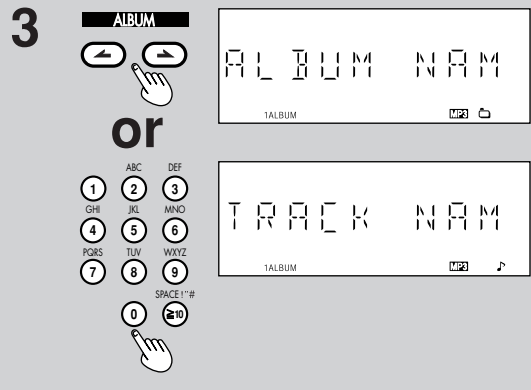
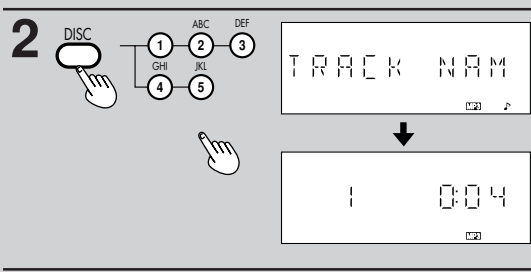
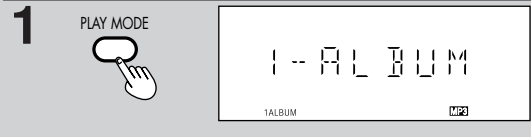
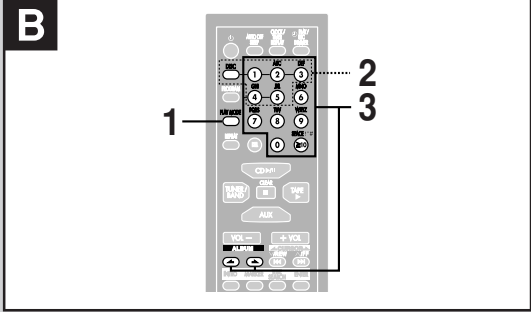
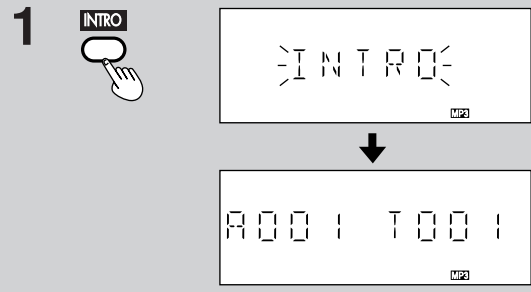
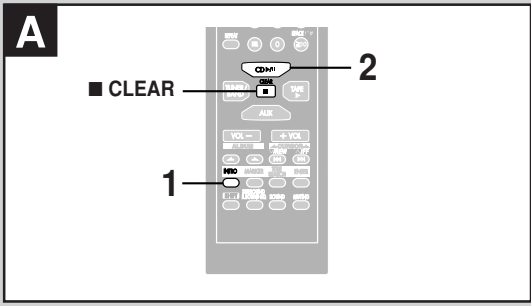

Enjoying MP3

A INTRO function (Album scan)

Listen to the first track of all albums in the current disc for 10 seconds each to find your desired album.

Preparation: Press [CD ►/||] and then [■ CLEAR].

- 1 Press [INTRO] to start INTRO function.
(INTRO function is cancelled after playing the first track in the last album on the current disc.)
- 2 While your desired album is playing, press [CD ►/||].
Play starts from the first track of the album.

To stop during the process, press [INTRO] or [■ CLEAR].

B CD Play Mode function for MP3

Mode	To
1-DISC	play one selected disc.
ALL-DISC	play all loaded discs in succession from the selected disc to the final disc ※.
1-TRACK	play one selected track on the selected disc.
1-ALBUM	play one selected album on the selected disc.

- 1 Press [PLAY MODE] to select:
 → 1-DISC → ALL-DISC → 1-TRACK
 ← 1-ALBUM ←
- 2 Press [DISC] and (within 10 seconds) [1]–[5] to select and start the disc.
- 3 • When you have selected 1-ALBUM in step 1. Press [ALBUM (← or →)] to select and start the album.
 • When you have selected 1-TRACK in step 1, press the numeric buttons to select and play will start.
 For two digit numbers, press [≥10] once then the two digits.
 For three digit numbers, press [≥10] twice then the three digits.

When playback ends
The current play mode will be retained.

When “NOT MP3/ERROR1” appears on the display
An unsupported MP3 format is being played. The unit will skip that track and play the next one.

※ **Final disc**
For example, if play starts from disc 4, disc 3 will be the “final disc”.

Order of progression:
Disc 4→5→1→2→3

Notes

- You can use repeat mode (↔ page 14) with CD Play Mode function.
- You cannot use program mode together with CD Play Mode function.

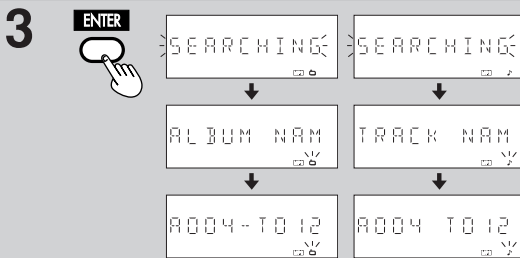
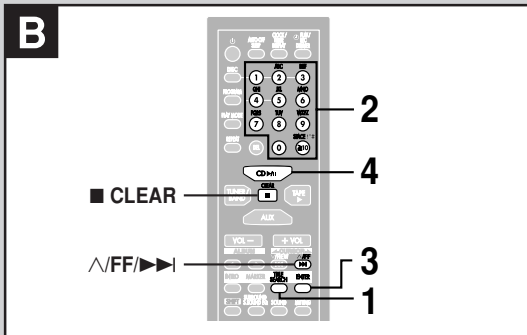
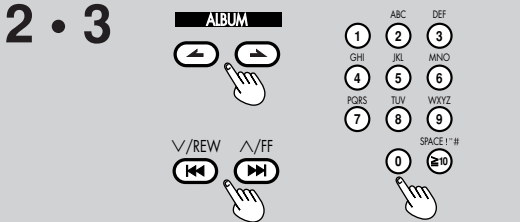
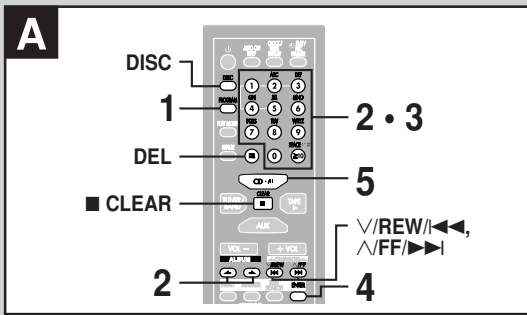

Enjoying MP3

A Program play for MP3

You can program up to 24 tracks.

Preparation:

1. Press [DISC] and (within 10 seconds) [1]–[5] to select the disc.
2. Press [CLEAR].

1 Press [PROGRAM].

“PGM” appears.

2 Press [ALBUM (← or →)] to select the album. To select an album directly, press the numeric buttons after pressing [ALBUM (← or →)].

For two digit numbers, press [≥10] once then the two digits.

For three digit numbers, press [≥10] twice then the three digits.

3 Press [V/REW/|<<<] or [^/FF/|>>>] to select the track. To select a track directly, press the numeric buttons after pressing [V/REW/|<<<] or [^/FF/|>>>].

4 Press [ENTER].

Repeat steps 2 to 4 to program other tracks.

5 Press [CD >||] to start play.

Play will start according to programmed sequence until the end.

To exit program mode.

Press [PROGRAM] in the stop mode. (You can replay your program by pressing [PROGRAM] then [CD >||].) You can do the following while “PGM” is displayed.

To	Action
check program contents	Press [V/REW/ <<<] or [^/FF/ >>>] in the stop mode.
add to the program	Repeat steps 2~4.
clear the last track	Press [DEL] in the stop mode.
clear all programmed tracks	Press [CLEAR]. Within 5 seconds, press the button again to clear all tracks. “CLEAR ALL” is displayed.

Notes

- You can use repeat mode (⇒ page 14) with program play.
- You cannot program more than one CD for MP3.
- You cannot program CD-DA together with MP3 tracks.
- The program memory is cleared when you change a disc or open the CD tray.

B Album/Track title search

Preparation: Press [CD >||] and then [CLEAR].

1 For album title search, press [TITLE SEARCH] once.

For track title search, press [TITLE SEARCH] twice.

2 Enter the album/track title keyword. (⇒ page 19)

3 Press [ENTER].

Press [^/FF/|>>>] to display the next title search result. “NOT FOUND” is displayed when there is no match.

4 Press [CD >||] to start play from the album/track found.

Title search mode is cancelled.

To cancel partway through

Press [CLEAR].

A

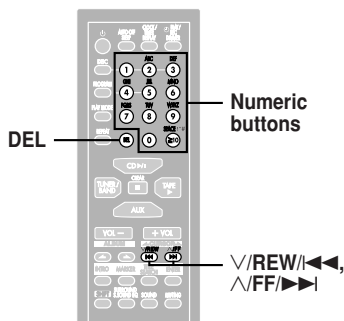

B

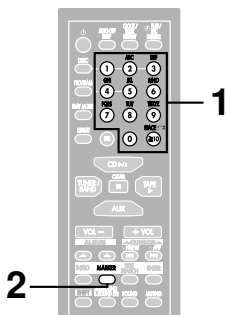

1



2

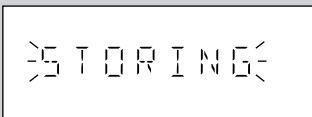

C

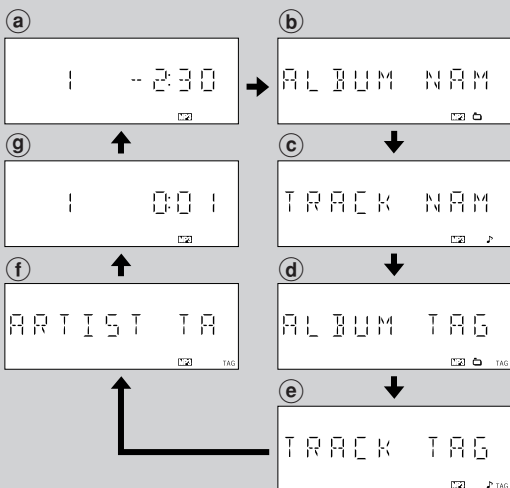
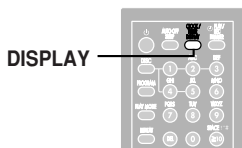

Enjoying MP3

A Entering characters

You can enter up to 9 characters for album/track title search.

- 1 Press the numeric buttons to select the required character.

Numbered buttons	Characters	Numbered buttons	Characters
1	1	6	M N O 6
2	A B C 2	7	P Q R S 7
3	D E F 3	8	T U V 8
4	G H I 4	9	W X Y Z 9
5	J K L 5	0	0
≥10	space !"# \$%&'()*+,-./:;=?_		

- 2 Press [▲/FF/▶▶] to enter character.

Editing keywords

Press [V/REW/◀◀] or [▲/FF/▶▶] to revise any characters. To delete, move the cursor over the character and press [DEL].

B Marking a track

You can mark one track each on the discs loaded so that you can start play from them later.

To mark a track number

- 1 During play or stop

For MP3, refer to "Track skip play" on page 16. For CD-DA, press the numbered buttons.

Select your desired track with the numeric buttons.

For two digit numbers, press [≥10] once then the two digits. For three digit numbers, press [≥10] twice then the three digits.

- 2 Hold down [MARKER] until "STORING" blinks on the display.

If you store a new track, the old track will be cleared.

To recall a marked track number in the current disc

During play or stop

Press [MARKER] to recall a marker and start play.

Notes

- "NO MARKER" indicates that the marker in the current disc is empty.
- The marker memory will be cleared when you open the CD tray.
- For CD-DA, you cannot use this function during 1-Disc Random play and All-Disc Random play.
- You cannot use this function during program mode.

C Display for MP3

During play or pause

Press [DISPLAY] to select your desired CD display.

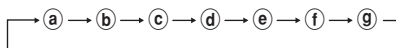

Notes

- When a title is longer than 9 characters, it will scroll across the display.
- "NO ID3" is displayed if titles with ID3 tags haven't been entered.
- Maximum number of displayable characters:
Album/track title: 31
ID3 album/title/artist name: 30
(ID3 is a tag embedded in MP3 track to provide information about the track.)
- This unit can display album and track titles with ID3 tags (version 1.0 and 1.1). Titles containing text data that the unit doesn't support cannot be displayed.

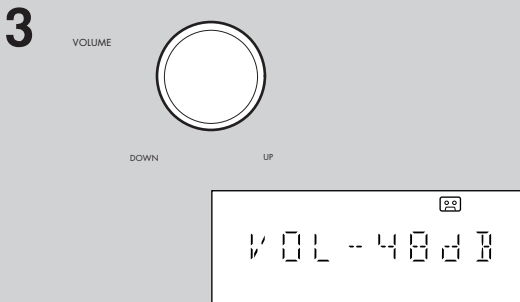
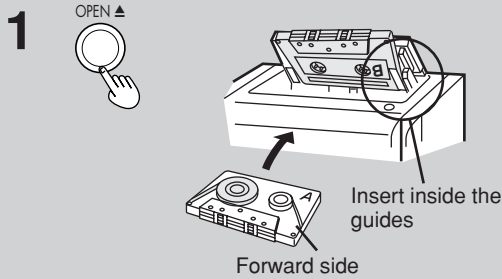
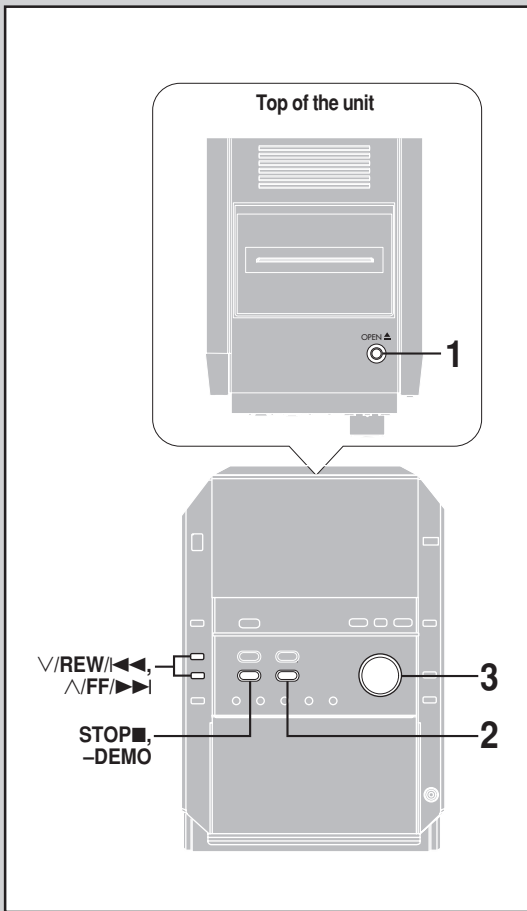

Cassette tapes

- 1 Press [OPEN ▲] to insert a cassette.**
Close the lid by hand.
- 2 Press [TAPE ▶] to start playback.**
Repeat step 1 and 2 to play the other side of the tape.
- 3 Adjust the volume.**

To	Action
stop tape playback	Press [STOP ■, - DEMO].
start one touch play	Press [TAPE ▶] when the system is OFF with the cassette loaded.
fast-forward and rewind	Press [V/REW/◀◀] or [∧/FF/▶▶] in the stop mode.

Cassette tape selection and care

Types of cassettes which can be played correctly
Only normal position tapes are recommended.

NORMAL POSITION/TYPE I	✓
HIGH POSITION/TYPE II	×
METAL POSITION/TYPE IV	×

- Tapes exceeding 100 minutes are thin and can break or get caught in the mechanism.
- Tape slack can get caught up in the mechanism and should be wound up before the tape is played.
- Endless tapes can get caught up in the deck's moving parts if used incorrectly.

To find the beginning of a program (TPS: Tape Program Sensor)

TPS finds the beginning of a track and resumes play from there. Each press increases the number of tracks skipped, up to a maximum of 9.

Press [V/REW/◀◀] or [∧/FF/▶▶] during play.

Note

The TPS function searches for silent parts of about 4 seconds in length which are normally found between tunes. As a result, it may not function properly in the following cases:

- With short silent parts
- When noise occurs between tunes
- With silent parts found within tunes

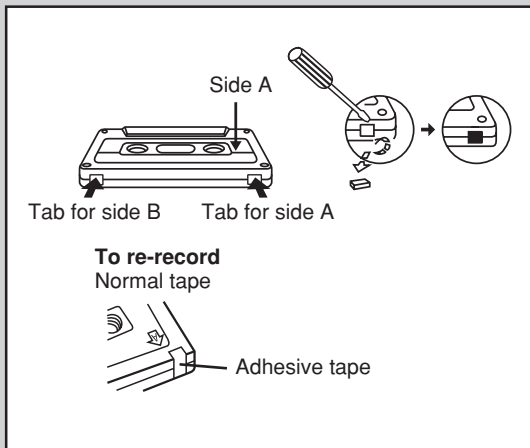

To re-record
Normal tape



OPEN ▲

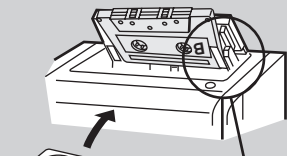

Insert inside the guides

Forward side

A

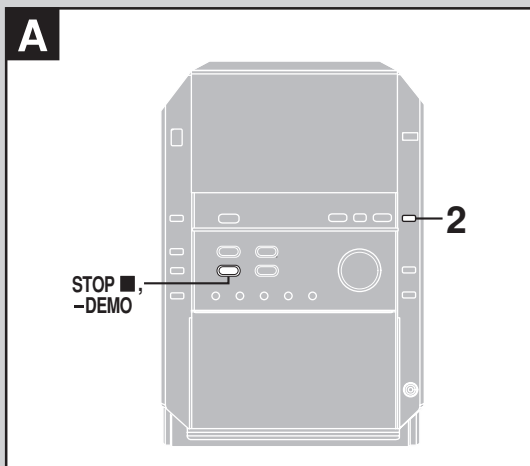

2



Before recording

- Only normal position tapes are recommended.
- Remove tabs to prevent recording. To record, cover tabs as shown.
- Volume and sound quality during playback have no effect on recording.

To erase a recorded sound

- ① Press [TAPE ►] and then [STOP ■, -DEMO].
- ② Insert the recorded cassette with the tape facing out.
- ③ Press [●/|| REC].

Preparatory steps

Wind up the leader tape to begin recording immediately.

Preparation: Press [TAPE ►] and then [STOP ■, -DEMO] to select tape as the source.

Press [OPEN ▲], insert a cassette with the tape facing out.

Close the lid by hand.

A Recording the radio

Preparation: Do the preparatory steps as above.

1 Tune to the required station.

(→ page 9)

2 Press [●/|| REC] to start recording.

To	Action
stop recording	Press [STOP ■, -DEMO].
stop recording temporarily	Press [●/ REC]. Press [●/ REC] again to resume recording.
cut an unnecessary part while recording	Press [●/ REC] during the unnecessary part. Press [●/ REC] again to resume recording.
record on the other side of the tape	Turn the tape over and press [●/ REC].

A

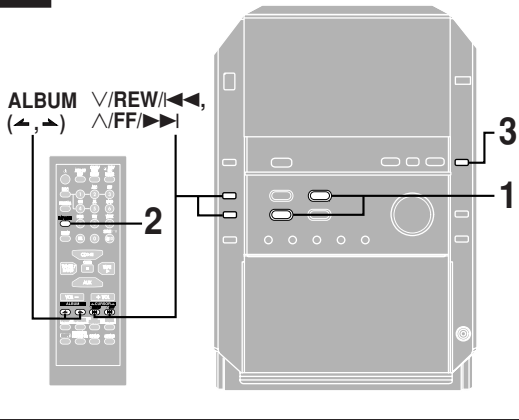

1



2



3

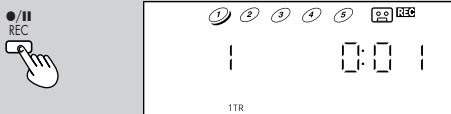

B

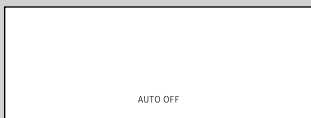
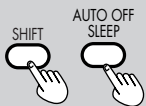
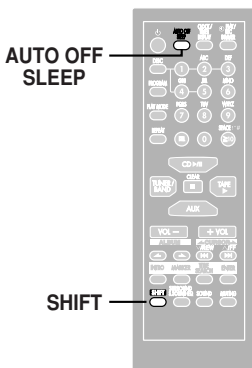

A Recording CDs

Mode	To
1-DISC	record one selected disc.
ALL-DISC	record all loaded discs in succession from the selected disc to the final disc.
1-TRACK	record one selected track on the selected disc.
1-ALBUM (MP3)	record one selected album on the disc.
1-RANDOM	record the disc in random order.
A-RANDOM	record all loaded discs in random order.

1 Press [CD ▶/||] and then [STOP ■, -DEMO].

2 Press [PLAY MODE] to select your desired mode.

For 1-TRACK mode

Press [V/REW/FF] or [V/FF/PAUSE] to select the track.

For 1-ALBUM mode (MP3)

Press [ALBUM (◀ or ▶)] to select the album.

For 1-DISC/1-RANDOM mode

Do steps 1 to 3 on page 13.

Ensure CD is stopped.

3 Press [●/|| REC] to start recording.

To	Action
stop recording	Press [STOP ■, -DEMO].
stop recording temporarily	Press [●/ REC]. If the tape finishes before the CD, press [STOP ■, -DEMO] to stop the CD. Press [●/ REC] to resume recording.

To record programmed tracks

This function allows you to record up to 24 programmed tracks.

1 Programme the track(s) you want.

(→ steps 1 - 6 on page 15)

2 Press [●/|| REC] to start recording.

B Auto-off function

To save power, the unit turns off if it is left unused for 10 minutes. This function works only if CD or tape is selected as the source. This function does not work if the source is tuner or AUX.

Press [SHIFT] + [AUTO OFF].

"AUTO OFF" is shown on the display.

To cancel

Press [SHIFT] + [AUTO OFF] again to clear "AUTO OFF" from the display.

For your reference

The setting is maintained even if the unit is turned off. When the unit is turned on again, "AUTO OFF" is displayed and the unit functions as described above.

"AUTO OFF" disappears from the display if either tuner or AUX is selected as the source but continues to function normally.

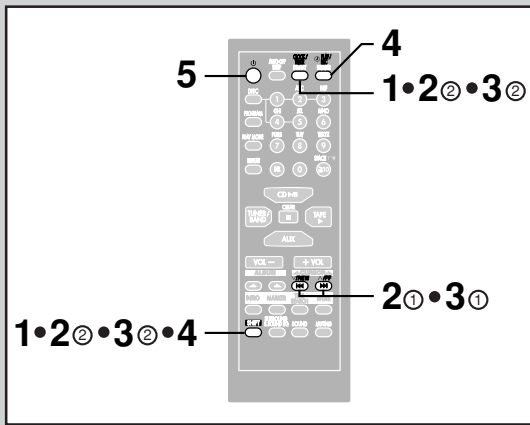

For Play Timer

For Record Timer



⊖PLAY ON

⊖REC ON

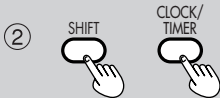
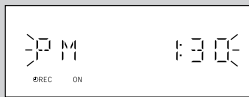

⊖PLAY OFF

⊖REC OFF

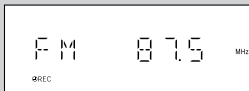
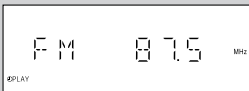
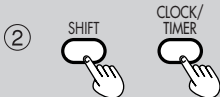
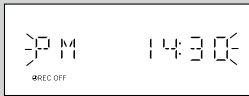

Using the timers

Using the play/record timer

The timer can be set as an alarm or radio recorder. Play timer and record timer cannot be used together.

Preparations:

Turn the unit on and set the clock (→ page 8).

Timer	Action
Play timer	Prepare the music source you want to listen to; tape, CD, radio or aux, and set the volume.
Record timer	Check the cassette's erasure prevention tabs (→ page 21), insert the cassette and tune to the radio station (→ page 10) or select the aux source (→ page 25).

1 Press [SHIFT] + [CLOCK/TIMER] to select:

Every time you press the button:

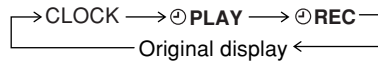

Timer	To
CLOCK	set the clock.
⊖ PLAY	set the play timer.
⊖ REC	set the record timer.
Original display	resume original display.

Setting the start and finish times

(Within 3 seconds)

- 1 Press [V/REW/◀◀] or [^/FF/▶▶] to select the starting time.
- 2 Press [SHIFT] + [CLOCK/TIMER].
- 3 1 Press [V/REW/◀◀] or [^/FF/▶▶] to select the finishing time.
- 2 Press [SHIFT] + [CLOCK/TIMER].

Turning the timer on

4 Press [SHIFT] + [⊖PLAY/REC] to select:

Every time you press the button:

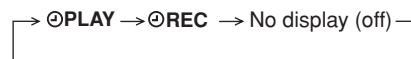

Timer	To
⊖ PLAY	turn on the play timer.
⊖ REC	turn on the record timer.
No display	turn off.

(The indicator doesn't appear if the start and finish times or the clock haven't been set.)

5 Press [⏻] to turn off the unit and timer will start.

Timer	Action
Play timer	Play will start in the set condition at the set time with volume increasing gradually to the set level.
Record timer	The unit comes on 30 seconds before the set time with the volume muted.

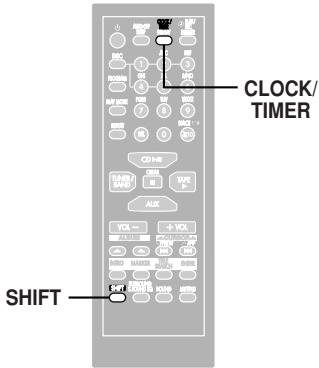
A**B**

Using the timers

To cancel the timer

Press [SHIFT] + [OPLAY/REC].

To change the settings when the unit is on

To change	Action
play/record times	Repeat steps 1, 2, 3, and 5 on previous page.
source/volume	<ol style="list-style-type: none"> ① Press [SHIFT] + [OPLAY/REC]. ② Make changes to the source or volume. ③ Do steps 4 to 5 on previous page.

A Using the play/record timer

To check the settings when the unit is on

Press [SHIFT] + [CLOCK/TIMER] until "OPLAY" or "OREC" appears. Two seconds after "OPLAY" or "OREC" appears, the settings are displayed in the following order:

Timer	Setting display
Play timer	Play start time → Play finish time → Play source → Playback volume.
Record timer	Recording start time → Recording finish time → Recording source.

When the unit is off, press [SHIFT] + [CLOCK/TIMER] to check the settings.

To enjoy the desired source after the timer setting is completed.

The volume level (for play timer) and music source are stored in the timer memory and the timer will start in these preset conditions. However, the CD numbers do not get stored in the timer memory.

1. After step 4 on the previous page, start playing the desired source.
2. Reset the CD numbers if you have changed any of them, confirm that a CD or cassette is inserted, then press [O] to put the unit on standby.

Notes

- If you turn the unit off and on again while a timer is functioning, the finish time setting will not be activated.
- If the unit is on, the timer will not function. The unit must be in the standby mode.
- If AUX is selected as the source, when the timer comes on, the system turns on and engages AUX as the source. If you want to playback or record from a connected unit, set the other unit's timer to the same time. (See the other unit's instruction manual.)

B Using the sleep timer

Using the sleep timer to turn off the unit automatically.

Press [SLEEP] to select:

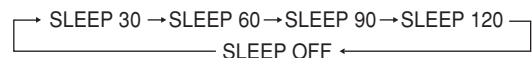

To cancel, Press [SLEEP] to select "SLEEP OFF".

To display the remaining time, press [SLEEP].

Press [SLEEP] again to change your desired time.

Notes

- The play and sleep timer or the record and sleep timer can be used together.
- The sleep timer always has priority. Be sure not to overlap timer settings.

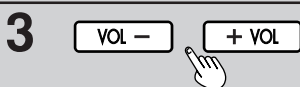
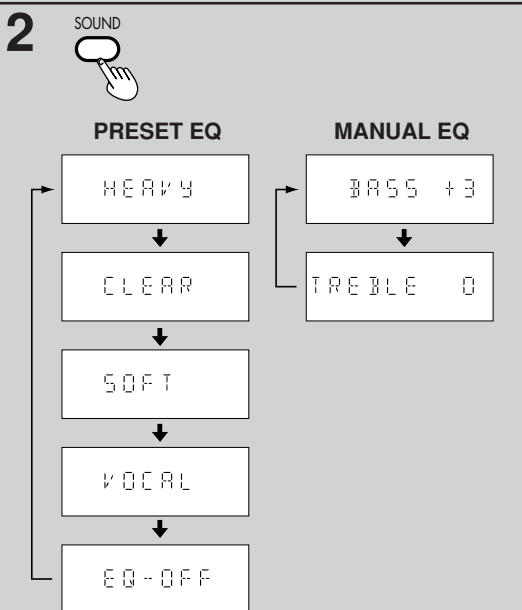
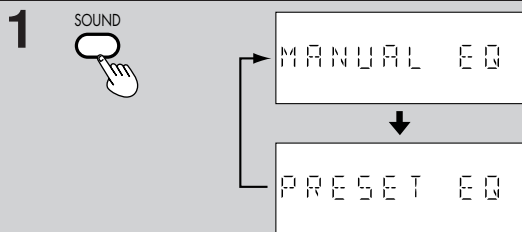
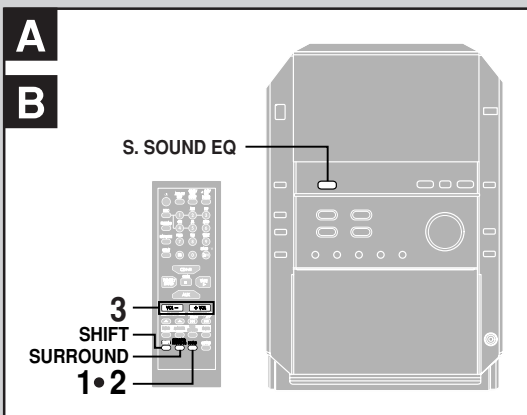
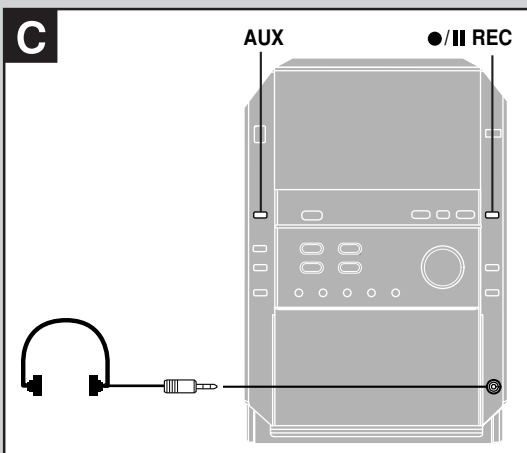
A**B****C****A Using the sound quality settings**

You can select sound quality with Preset EQ and improve bass and treble effect with Manual EQ.

Preset EQ

1 Press and hold [SOUND] to select “PRESET EQ”.

Each time you press and hold the button:

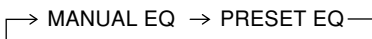

2 Press [SOUND] to select:

Each time you press the button:

Setting**Sound quality**

HEAVY	Adds punch to rock
CLEAR	Clarifies higher frequencies
SOFT	For background music
VOCAL	Adds gloss to vocal
EQ-OFF	Cancelled

Manual EQ

1 Press and hold [SOUND] to select “MANUAL EQ”.

Each time you press and hold the button:

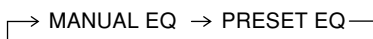

2 Press [SOUND] to select a setting.

Each time you press the button:

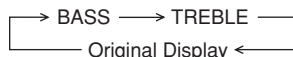

3 Press [VOL -] or [+ VOL] to adjust the level.

The tone level can be varied within a range of -3 to +3.

Notes

- Preset EQ cannot be used together with Super Sound EQ.
- Changes to sound quality do not affect recordings.

B Enhancing the sound quality

Press [S.SOUND EQ].

The button light is on.

Press the button again to cancel.

The button light goes out.

Using the “live” effect (SURROUND)

Press [SHIFT] + [SURROUND] to add natural width and depth to the stereo sound. “■■■■■ ■■■■” indicator will appear.

To cancel

Press [SHIFT] + [SURROUND] to clear the “■■■■■ ■■■■” indicator.

- When listening through headphones, the effect is less discernible than through the unit’s speakers.
- If interference in FM stereo reception increases, cancel the surround sound effect.

C Using an external unit

① Press [AUX].

② **For listening:** Proceed to step ③.

For recording: Press [●/|| REC] (recording starts).

③ Start playback from the external source. (For details, refer to the external unit’s instruction manual.)

Listening with headphones

Reduce the volume level, and connect the headphones. Plug type: 3.5 mm stereo.

Note

Avoid listening for prolonged periods of time to prevent hearing damage.

Troubleshooting guide

Before requesting service, make the following checks. If you are in doubt about some of the check points, or if the remedies indicated in the chart do not solve the problem, refer to the “Customer Services Directory” on page 27 if you reside in the U.S.A., or refer to the “Product information” on page 4 if you reside in Canada.

Reference pages are shown as black circled numbers.

Common Problems

No sound.	Turn the volume up. The speaker cords may be shorted. Turn the unit off, check and correct the connections and turn the unit on. ⑥
Sound is unfixed, reversed or comes from one speaker only.	Check the speaker connections. ⑥
Humming heard during play.	An AC power supply cord or fluorescent light is near the cables. Keep other appliances and cords away from this unit's cables.
“ERROR” is displayed.	Incorrect operation performed. Read the instructions and try again.
“_ _: _ _” appears on the display.	You plugged the AC power supply cord in for the first time or there was a power failure recently. Set the time. ⑧
“F61” is displayed.	Check and correct the speaker cord connections. ⑥ If this does not fix the problem, there is a power supply problem. Consult the dealer.

Listening to the radio

Noise is heard. The stereo indicator flickers or doesn't light. Sound is distorted.	Use an outdoor antenna. ⑥
A beat sound is heard.	Turn the TV off or separate it from the unit.
A low hum is heard during AM broadcast.	Separate the antenna from other cables and cords.

When there is a television set nearby

The picture on the TV disappears or stripes appear on the screen.	The location and orientation of the antenna are incorrect. If you are using an indoor antenna, change to an outdoor antenna. ⑥ The TV antenna wire is too close to the unit. Separate the antenna wire of the TV set from the unit.
---	--

Using the cassette deck

Recording is not possible.	If the erasure prevention tabs have been removed, cover the holes with adhesive tape. ⑫
----------------------------	---

Playing discs

The display is wrong or play won't start.	The disc may be upside down. ⑫ Wipe the disc. Replace the disc if it is scratched, warped, or non-standard. Condensation may have formed inside the unit due to a sudden change in temperature. Wait about an hour for it to clear and try again.
The total number of tracks displayed differs each time the same disc is inserted. Unusual sound is heard.	The disc may be scratched, or its data may be defective. Replace the disc.
CD-RW cannot be read.	The disc was incompletely formatted. Use the recording equipment to fully format the disc before recording.
“VBR-” is displayed instead of the remaining play time.	The unit cannot display the remaining play time for variable bit rate (VBR) tracks.
“TAKE OUT/DISC” appears on the display.	There is a problem with the disc mechanism. (A power failure may have occurred.) The tray will open automatically. Remove the disc from the tray, and after ensuring there is no disc in the tray, close it. The unit will make the disc changing noises for a few moments and then it should operate normally.

The remote control

Remote control doesn't work.	Check that the batteries are inserted correctly. ⑤ Replace the batteries if they are worn.
------------------------------	---

Warranty (ONLY FOR U.S.A)

Panasonic Consumer Electronics Company,
Division of Matsushita Electric Corporation of America
One Panasonic Way Secaucus, New Jersey 07094

Panasonic Sales Company, Division of Matsushita Electric
of Puerto Rico, Inc.
Ave. 65 de Infantería, Km. 9.5
San Gabriel Industrial Park, Carolina, Puerto Rico 00985

Panasonic Audio Products Limited Warranty

Limited Warranty Coverage

If your product does not work properly because of a defect in materials or workmanship, Panasonic Consumer Electronics Company or Panasonic Sales Company (collectively referred to as "the warrantor") will, for the length of the period indicated on the chart below, which starts with the date of original purchase ("warranty period"), at its option either (a) repair your product with new or refurbished parts, or (b) replace it with a new or a refurbished product. The decision to repair or replace will be made by the warrantor.

Product or Part Name	Parts	Labor
Audio Products (except items listed below)	One (1) year	One (1) year
All Audio Racks (cabinets)	Thirty (30) days	Not Applicable
Technics Stand Alone Speakers, Subwoofer Speakers	Three (3) years	Three (3) years
USB Reader-Writer, Personal Computer Card Adapters (in exchange for defective item)	One (1) year	Not Applicable
Accessories: Headphones, Cartridges, Microphones, Adapters	Ninety (90) days	Ninety (90) days
Rechargeable Batteries, DVD-R/-RAM Discs (in exchange for defective item)	Ten (10) days	Not Applicable
SD Memory Cards, Rechargeable Battery Packs (in exchange for defective item)	Ninety (90) days	Not Applicable

During the "Labor" warranty period there will be no charge for labor. During the "Parts" warranty period, there will be no charge for parts. You must carry-in or mail-in your product during the warranty period. If non-rechargeable batteries are included, they are not warranted. This warranty only applies to products purchased and serviced in the United States or Puerto Rico. This warranty is extended only to the original purchaser of a new product which was not sold "as is". A purchase receipt or other proof of the original purchase date is required for warranty service.

Carry-In or Mail-In Service

For Carry-In or Mail-In Service in the United States call 1-800-211-PANA (1-800-211-7262) or visit Panasonic web site: <http://www.panasonic.com>
For assistance in Puerto Rico call Panasonic Sales Company (787)-750-4300 or fax (787)-768-2910.

Limited Warranty Limits And Exclusions

This warranty ONLY COVERS failures due to defects in materials or workmanship, and DOES NOT COVER normal wear and tear or cosmetic damage. The warranty ALSO DOES NOT COVER damages which occurred in shipment, or failures which are caused by products not supplied by the warrantor, or failures which result from accidents, misuse, abuse, neglect, mishandling, misapplication, alteration, faulty installation, set-up adjustments, misadjustment of consumer controls, improper maintenance, power line surge, lightning damage, modification, or commercial use (such as in a hotel, office, restaurant, or other business), rental use of the product, service by anyone other than a Factory Servicenter or other Authorized Servicer, or damage that is attributable to acts of God.

THERE ARE NO EXPRESS WARRANTIES EXCEPT AS LISTED UNDER "LIMITED WARRANTY COVERAGE". THE WARRANTOR IS NOT LIABLE FOR INCIDENTAL OR CONSEQUENTIAL DAMAGES RESULTING FROM THE USE OF THIS PRODUCT, OR ARISING OUT OF ANY BREACH OF THIS WARRANTY. (As examples, this excludes damages for lost time, travel to and from the servicer, loss of media or images, data or other memory content. The items listed are not exclusive, but are for illustration only.) **ALL EXPRESS AND IMPLIED WARRANTIES, INCLUDING THE WARRANTY OF MERCHANTABILITY, ARE LIMITED TO THE PERIOD OF THE LIMITED WARRANTY.**

Some states do not allow the exclusion or limitation of incidental or consequential damages, or limitations on how long an implied warranty lasts, so the exclusions may not apply to you.

This warranty gives you specific legal rights and you may also have other rights which vary from state to state. If a problem with this product develops during or after the warranty period, you may contact your dealer or Servicenter. If the problem is not handled to your satisfaction, then write to the warrantor's Consumer Affairs Department at the addresses listed for the warrantor.

PARTS AND SERVICE WHICH ARE NOT COVERED BY THIS LIMITED WARRANTY ARE YOUR RESPONSIBILITY.

Customer Services Directory (ONLY FOR U.S.A)

Obtain Product Information and Operating Assistance; locate your nearest Dealer or Servicenter; purchase Parts and Accessories; or make Customer Service and Literature requests by visiting our Web Site at:

<http://www.panasonic.com/support>

or, contact us via the web at:

<http://www.panasonic.com/contactinfo>

You may also contact us directly at:

1-800-211-PANA (7262),

Monday-Friday 9 am-9 pm; Saturday-Sunday 10 am-7 pm, EST.

For hearing or speech impaired TTY users, TTY: 1-877-833-8855

Accessory Purchases

Purchase Parts, Accessories and Instruction Books online for all Panasonic Products by visiting our Web Site at:

<http://www.pasc.panasonic.com>

or, send your request by E-mail to:

npcparts@panasonic.com

You may also contact us directly at:

1-800-332-5368 (Phone) 1-800-237-9080 (Fax Only) (Monday-Friday 9 am to 8 pm, EST.)

Panasonic Services Company

20421 84th Avenue South, Kent, WA 98032

(We Accept Visa, MasterCard, Discover Card, American Express, and Personal Checks)

For hearing or speech impaired TTY users, TTY: 1-866-605-1277

Service in Puerto Rico

Matsushita Electric of Puerto Rico, Inc. Panasonic Sales Company/Factory Servicenter:
Ave. 65 de Infantería, Km. 9.5, San Gabriel Industrial Park, Carolina, Puerto Rico 00985
Phone (787)750-4300, Fax (787)768-2910

Specifications

AMPLIFIER SECTION

Power output

10% Total harmonic distortion
60 Hz–3 kHz, both channels driven

(Low channel) **SC-PM19** 26 W per channel (6 Ω)

SC-PM193 25 W per channel (6 Ω)

3 kHz–16 kHz, both channels driven

(High channel) **SC-PM19** 29 W per channel (6 Ω)

SC-PM193 25 W per channel (6 Ω)

Total Bi-Amp power **SC-PM19** 55 W per channel

SC-PM193 50 W per channel

Power output

10% Total harmonic distortion
1 kHz, both channels driven

(Low channel) **SC-PM19** 35 W per channel (6 Ω)

SC-PM193 30 W per channel (6 Ω)

8 kHz, both channels driven

(High channel) **SC-PM19** 35 W per channel (6 Ω)

SC-PM193 30 W per channel (6 Ω)

Total Bi-Amp power **SC-PM19** 70 W per channel

SC-PM193 60 W per channel

Output Impedance

Headphone 16 Ω – 32 Ω

FM TUNER SECTION

Frequency range

87.5 MHz – 108.0 MHz (100 kHz steps)

87.9 MHz – 107.9 MHz (200 kHz steps)

Sensitivity 1.5 μV (IHF)

S/N 26 dB 1.5 μV

Antenna terminal(s) 75 Ω (unbalanced)

AM TUNER SECTION

Frequency range 520 kHz – 1710 kHz (10 kHz steps)

Sensitivity 560 μV/m

S/N 20 dB (at 1000 kHz)

CASSETTE DECK SECTION

Track system 4 track, 2 channel

Heads

Record/playback Solid permalloy head

Erase Double gap ferrite head

Motor DC servo motor

Recording system AC bias 100 kHz

Erasing system AC erase 100 kHz

Tape speed 4.8 cm/s

Overall frequency response

(+3 dB, –6 dB at DECK OUT)

NORMAL (TYPE I) 35 Hz – 14 kHz

S/N RATIO 45 dB (A weighted)

Wow and flutter 0.10% (WRMS)

Fast forward and rewind time

Approx. 120 seconds with
C-60 cassette tape

CD SECTION

Disc

CD, CD-R, CD-RW, MP3 8 cm/12 cm (3³/₂₀"/4⁷³/₁₀₀"

Sampling frequency 44.1 kHz

Decoding 16 bit linear

Beam source/wavelength Semiconductor laser/780 nm

Number of channels Stereo

Frequency response 20 Hz–20 kHz (+1 dB, –2 dB)

Wow and flutter Below measurable limit

Digital filter 8 fs

D/A converter MASH (1 bit DAC)

MP3

Bit rate 32 kbps–320 kbps

Sampling frequency 32 kHz, 44.1 kHz, 48 kHz

SPEAKER SECTION

Type 2 way, 2 speaker system

Speaker(s)

Full Range 10 cm (4") cone type

Tweeter 6 cm (2³/₈") cone type

Impedance 6 Ω

Input power

HIGH 70 W (Max)

LOW 70 W (Max)

Output sound pressure level 80 dB/W (1.0 m)

Frequency range 55 Hz–22 kHz (–16 dB)

70 Hz–20 kHz (–10 dB)

Dimensions (WxHxD) 128 mm x 250 mm x 222 mm

(5¹/₃₂" x 9²⁷/₃₂" x 8³/₄"

Mass 1.95 kg (4.30 lbs.)

GENERAL

Power supply AC 120 V, 60 Hz

Power consumption 130 W

Dimensions (WxHxD) 179 mm x 250 mm x 383 mm

(7¹/₁₆" x 9²⁷/₃₂" x 15³/₃₂"

Mass 5.24 kg (11.55 lbs.)

Power consumption in standby mode: 0.8W

Notes:

- Specifications are subject to change without notice. Mass and dimensions are approximate.
- Total harmonic distortion is measured by the digital spectrum analyzer.
- The labels "HIGH" and "LOW" on the rear of the speakers refer to High frequency and Low frequency.

Maintenance

If the surfaces are dirty

To clean this unit, wipe with a soft, dry cloth.

- Never use alcohol, paint thinner or benzine to clean this unit.
- Before using chemically treated cloth, read the instructions that came with the cloth carefully.

For a cleaner crisper sound

Clean the heads regularly to assure good quality playback and recording.

Use a cleaning tape (not included).

When moving the unit

- Remove all discs.
- Press [⏻/I POWER] to turn the unit off.
- Disconnect the AC power supply cord.

Panasonic Consumer Electronics Company, Division of Matsushita Electric Corporation of America

One Panasonic Way Secaucus, New Jersey 07094

<http://www.panasonic.com>

Panasonic Sales Company, Division of Matsushita Electric of Puerto Rico, Inc. ("PSC")

Ave. 65 de Infantería, Km. 9.5 San Gabriel Industrial Park, Carolina, Puerto Rico 00985

Panasonic Canada Inc.

5770 Ambler Drive Mississauga, Ontario, L4W 2T3 www.panasonic.ca

