



**Wireless Serial-Ethernet Server  
STW-602C  
User's Manual**

Version 1.1

---

## Important Announcement

The information contained in this document is the property of Aaxeon Technologies, LLC and is supplied for the sole purpose of operation and maintenance of products of Aaxeon Technologies, LLC. No part of this publication is to be used for any other purposes, and it is not to be reproduced, copied, disclosed, transmitted, stored in a retrieval system, or translated into any human or computer language, in any form, by any means, in whole or in part, without the prior explicit written consent of Aaxeon Technologies, LLC.

### **Published by**

Aaxeon Technologies, LLC  
Toll-Free: 1-877-AAXEON-5  
1-877-229-3665  
e-Mail: [info@aaxeon.com](mailto:info@aaxeon.com)  
Website: [www.aaxeon.com](http://www.aaxeon.com)

Copyright © 2008 Aaxeon Technologies, LLC All rights reserved.

All other product names referenced herein are registered trademarks of their respective companies.

# **FCC WARNING**

## **Class B for this product**

This product has been tested and found to comply with the limits for a Class B digital device, pursuant to Part 15 of the FCC Rules. These limits are designed to provide reasonable protection against harmful interference in a residential installation. This equipment generates uses and can radiate radio frequency energy and, if not installed and used in accordance with the instructions, may cause harmful interference to radio communications. However, there is no guarantee that interference will not occur in a particular installation. If this equipment does cause harmful interference to radio or television reception, which can be determined by turning the equipment off and on, the user is encouraged to try to correct the interference by one of the following measures:

- Reorient or relocate the receiving antenna.
- Increase the separation between the equipment and receiver.
- Connect the equipment into an outlet on a circuit different from that to which the receiver is connected.
- Consult the dealer or an experienced radio/TV technician for help.

This product complies with Part 15 of the FCC Rules. Operation is subject to the following two conditions: (1) This device may not cause harmful interference, and (2) this device must accept any interference received, including interference that may cause undesired operation.

**FCC Caution: Any changes or modifications not expressly approved by the party responsible for compliance could void the user's authority to operate this equipment.**

### **IMPORTANT NOTE:**

#### **FCC Radiation Exposure Statement:**

This product complies with FCC radiation exposure limits set forth for an uncontrolled environment. This model should be installed and operated with minimum distance 20cm between the radiator & your body.

This transmitter must not be co-located or operating in conjunction with any other antenna or transmitter. IEEE 802.11b/g operation of this product in the U.S.A. is firmware-limited to channels 1 through 11.

# **UL NOTICE FOR POWER SUPPLIER**

The STW-602C product is intended to be supplied by a Listed Power Unit marked with "LPS", "Limited Power Source" or "Class 2" and output rate 9~48VDC, 1.0A minimum. Or, use the recommended power supply in "Optional Accessories".

# Contents

<b>1. Introduction</b> .....	<b>1</b>
1.1. Overview .....	1
1.2. Features .....	1
<b>2. Getting Started</b> .....	<b>2</b>
2.1. Packaging Include.....	2
2.2. Ordering information .....	2
2.3. Interfaces .....	2
2.4. Installation Procedures .....	2
<b>3. Software Setup</b> .....	<b>3</b>
3.1. Default Settings.....	3
3.2. IP Assignment .....	3
3.2.1. <i>Configure IP by SerialManager Utility</i> .....	4
3.2.2. <i>Configure IP by web server</i> .....	5
3.2.3. <i>Configure IP by Telnet utility</i> .....	5
3.2.4. <i>Auto IP with DHCP</i> .....	5
3.3. TCP/IP Port Number .....	5
<b>4. Application Connectivity</b> .....	<b>6</b>
4.1. TCP & UDP Protocols .....	6
4.1.1. <i>Transmission Control Protocol (TCP)</i> .....	6
4.1.2. <i>User Datagram Protocol (UDP)</i> .....	6
4.2. Connectivity Topology .....	6
4.2.1. <i>Virtual COM Mode</i> .....	6
4.2.2. <i>Tunneling Mode</i> .....	8
<b>5. Configure STW-602C by web interface</b> .....	<b>10</b>
5.1. Login to System .....	10
5.2. General Information .....	10
5.3. Network Configuration .....	13
5.3.1. <i>LAN Settings</i> .....	14
5.3.2. <i>WLAN Settings</i> .....	14
5.3.3. <i>DNS Settings</i> .....	14
5.3.4. <i>SNMP Settings</i> .....	14
5.4. Wireless Configuration.....	15
5.4.1. <i>Wireless Detail Settings</i> .....	16
5.4.2. <i>Sample Wireless Application Cases</i> .....	16
5.5. COM Port Configuration.....	18
5.5.1. <i>Link Mode Settings</i> .....	19
5.5.2. <i>TCP Server Mode</i> .....	19
5.5.3. <i>TCP Client Mode</i> .....	20
5.5.4. <i>UDP Mode</i> .....	20
5.5.5. <i>Serial Settings</i> .....	21
5.5.6. <i>Delimiter Settings</i> .....	21
5.6. Configure System .....	22
5.6.1. <i>Configure Time by NTP Service</i> .....	22

5.6.2.	Configure WLAN Region .....	23
5.6.3.	<i>Change the Password</i> .....	23
5.6.4.	<i>Restoring Factory Default</i> .....	24
5.6.5.	<i>Restart System</i> .....	24
<b>6.</b>	<b>Telnet Configuration .....</b>	<b>25</b>
6.1.	General Information .....	26
6.2.	Networking Configuration.....	27
6.2.1.	<i>LAN Settings</i> .....	28
6.2.2.	<i>DNS Settings</i> .....	28
6.2.3.	<i>SNMP Settings</i> .....	29
6.3.	Wireless Configuration.....	32
6.3.1.	Wireless IP, Netmask, Gateway, and IP mode Settings .....	33
6.3.2.	Configure Region.....	34
6.3.3.	<i>Site Survey</i> .....	34
6.3.4.	<i>Manual Wireless Settings</i> .....	35
6.3.5.	<i>Configure Ad-Hoc Mode:</i> .....	36
6.3.6.	<i>Configure Infrastructure Mode</i> .....	37
6.4.	COM Port Configuration.....	37
6.4.1.	<i>TCP Server Mode for Link Mode</i> .....	38
6.4.2.	<i>TCP Client for Link Mode</i> .....	39
6.4.3.	<i>UDP for Link Mode</i> .....	39
6.4.4.	<i>Serial Settings</i> .....	40
6.4.5.	<i>Packet Delimiter</i> .....	40
6.5.	Security Configuration.....	42
6.5.1.	<i>Change the Password</i> .....	43
<b>Appendix A.</b>	<b>Using Virtual COM .....</b>	<b>44</b>
A.1.	<i>Pre-installation Requirements</i> .....	44
A.2.	<i>Applying to the Serial Server</i> .....	44
A.3.	<i>Virtual COM Communication</i> .....	45
<b>Appendix B.</b>	<b>Configuration Utility .....</b>	<b>48</b>
B.1.	<i>SerialManager Utility Introduction</i> .....	53
B.2.	<i>Interface</i> .....	53
B.3.	<i>Functions</i> .....	53
<b>Appendix C.</b>	<b>Upgrading System Software .....</b>	<b>64</b>
C.1.	<i>System Upgrading Procedures</i> .....	64
C.2.	<i>Critical Issues in Upgrading Process</i> .....	64
<b>Appendix D.</b>	<b>Specifications .....</b>	<b>66</b>
D.1.	<i>Hardware Specifications</i> .....	66
D.2.	<i>Software Specifications</i> .....	67
D.3.	<i>Pin Assignments</i> .....	67
D.4.	<i>Beep &amp; LED Status</i> .....	61

## **1. Introduction**

### **1.1. Overview**

The STW-602C Wireless Serial Server is a gateway between wireless LAN or Ethernet (TCP/IP) and RS-232/RS-485 communications. It allows almost any serial devices to be connected to a new or existing wireless network. The information transmitted by Serial Server is transparent to both host computers (IP network over wireless LAN or Ethernet) and devices (RS-232/RS-485). Data from the wireless LAN or Ethernet (TCP/IP) is transmitted to the designated RS-232/RS-485 port and data from RS-232/RS-485 port is transmitted to the Wireless or Ethernet (TCP/IP) transparently.

In the computer integration manufacturing or industrial automation area, Wireless Serial Server is used for field devices to direct connect to network. Terminal Server (main control program run in the STW-602C) transforms whatever data received from RS-232/RS-485 to TCP/UDP port then connects devices to the IP network via a single application program or multiple application programs.

Many control devices provide the ability to communicate with hosts through RS-232/RS-485 however RS-232/RS-485 serial communication has its limitations. For instance, it is hard to transfer data through a long distance. With the STW-602C, it is possible to communicate with a remote device in the Intranet environment or even in the Internet and thus, increases the communication distance dramatically.

Flexible configuration options enable this unit to be setup remotely over IP network by Telnet, web browser, or Window utility. Packed in a rugged DIN Rail mountable case and 9~48V DC power input range, the STW-602C is ideal for almost any industrial and manufacturing automation.

### **1.2. Features**

- Dual-port DIN-Rail mounting module.
- Metal housing with IP50 standard.
- 15KV ESD protection for serial ports
- IEEE 802.11g 54Mbps wireless network connectivity
- Support UDP, TCP server and client protocols for Virtual COM mode and pair connection
- Selectable RS-232/RS-485/RS-422 serial mode by software
- Configurable via console, telnet, built-in web server and Windows-based utilities
- Standard 2.4GHz High-gain antenna
- Upgradeable firmware via network

## 2. Getting Started

### 2.1. Packaging Include

- Wireless Serial Server x 1
- 5 pins Terminal Block for Serial Connector (TB model only) x 2
- 3 pins Terminal Block for Power Connector (TB model only) x 1
- 4 dBi Antenna x 1
- Wall mount kits x 2
- Wireless Serial Server quick start guide x 1
- Product CD containing configuration utility x 1

\* **NOTE:** Notify your sales representative if any of the above items is missing or damaged.

### 2.2. Ordering information

**STW-601C**

2-ports wireless serial server with D-Sub 9pin serial connector

### 2.3. Interfaces

The STW-602C interface is shown by **Fig 1.**

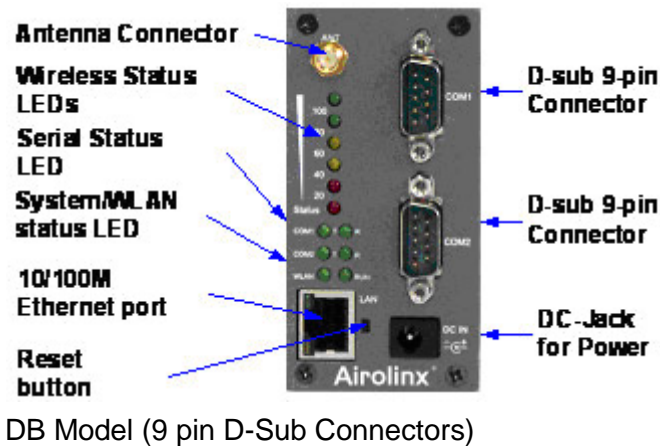

**Fig 1. STW-602C Interfaces**

### 2.4. Installation Procedures

- Prepare necessary cables, DC power adapter and RS-232/RS-485 connector.
- Place STW-602C under the access point signal coverage area, or connect STW-602C to Ethernet cable with RJ45 connector.
- Connect STW-602C serial port to serial device, make sure the connector and wiring of RS-232 or RS-485 is correct.
- Plug in STW-602C to DC-9-48V power source (with DC-jack or 3-pin terminal block connector), buzzer will beep and the RUN LED will blink if STW-602C functions normally. For LED Status sees Appendix D4

Use **SerialManager** configuration utility on the product CD to check the status of STW-602C. If it starts up successfully, User shall find the IP and MAC address of STW-602C. User can change IP address, gateway IP address and subnet mask networking parameters of STW-602C according to user networking configurations.

## Software Setup

Now the STW-602C hardware is installed and power is on, network IP configuration will be set in this section.

### 2.5. Default Settings

The STW-602C has two IP addresses one for Ethernet interface and another one for wireless network interface. These default settings are shown from under information

#### Default IP addresses

Interface	Device IP	Subnet mask	Gateway IP
LAN port	10.0.0.50.100	255.255.0.0	10.0.0.254
WLAN Port	192.168.1.1	255.255.255.0	192.168.1.254

The other default settings of STW-602C are shown in the following table

Property	Default Value
<b>Ethernet Port</b>	
IP Address	10.0.50.100
Gateway	10.0.0.254
Subnet Mask	255.255.0.0
<b>WLAN Port</b>	
IP Address	192.168.1.100
Gateway	192.168.1.254
Subnet Mask	255.255.255.0
<b>Security</b>	
User Name	<b>Admin</b>
Password	<b>Null (Leave it blank)</b>
<b>Serial</b>	
COM	9600/None/ 8/1, No flow control, packet delimiter disabled
Link Mode	TCP Server, Listen port 4660/4661, No Filter, Virtual COM disabled
<b>SNMP</b>	
SysName of SNMP	Name
SysLocation of SNMP	Location
SysContact of SNMP	Contact

Table 1. Default settings of the STW-602C device

\* **NOTE:** Press reset button for 5 seconds then release the button to restart STW-602C to the default settings.

\* **Warning:** Please avoid setting LAN and WLAN IP address in the same subnet, that may make unexpect networking problem.

### 2.6. IP Assignment



### 2.6.1. Configure IP by SerialManager Utility

Use **SerialManager** configuration utility that comes with product CD or diskette to configure the network parameters. For more details, please refer to [Appendix B1](#).

#### Find new device and IP assignment

- Use **SerialManager Utility** for finding new device IP address, get device's current IP from table list
- Re-assigned IP, network mask and gateway if need with **SerialManager Utility**.
- User can configure User ID, Password and Host Name with **SerialManager Utility**.



Fig 2. IP settings for SerialManager Utility tool

\* **Note:** All settings were NOT changed if user ID or password was incorrect.

If there is more than one device using the same IP address in same Subnet. User has to correct mapping between MAC address & IP address by ARP commands.

#### ARP commands

ARP (address resolution protocol) commands can be used to assign a static IP address on STW-602C using its hardware MAC (media access control) address. The MAC address "0060E9-xxxxxx" is printed on the rear side of STW-602C. The following figure shows how to use ARP command on MS-DOS command prompt window.

**Example:** Set IP 10.0.50.101 to MAC address 00-60-E9-00-79-F8.

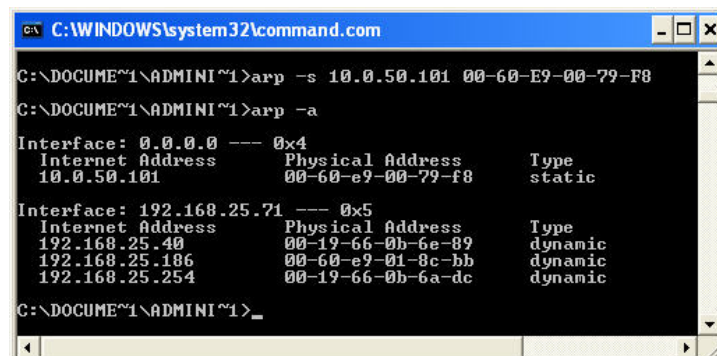

Fig 3. Map IP address to MAC address by ARP Command

\* **Note:** ARP commands can only be used to set a static IP address of STW-602C

- **arp -a** command show the current mapping IP and MAC addresses.
- **arp -s** "IP address" "MAC address" map the IP address to specify MAC address.

### 2.6.2. Configure IP by web interface

Use common Web browser, ex. Microsoft Internet Explorer or Mozilla Firefox, to configure the network parameters of STW-602C.

- Open web browser, type in the **IP address** (default IP: 10.0.50.100) of STW-602C to be configured. Default user name is **admin** and default password is **null** (leave it blank).
- Configure IP settings from web **Network links page** then click "**Save Configuration**" to save settings.
- Click on "**Restart**" button to make the change effective.

Please refer to contents of [Web Configuration section](#) for more details.

### 2.6.3. Configure IP by Telnet utility

Use common Telnet utility, ex. Microsoft Hyper-terminal, to configure the network parameters of STW-602C.

- Run command **telnet "IP address"** to telnet to STW-602C. **Default IP address is 10.0.50.100** and default password is **null** (leave it blank).
- Configure IP settings from **network settings** menu, and **restart** system after saved settings.

Please refer to [Telnet Configuration](#) section for more details.

### 2.6.4. Auto IP with DHCP

**DHCP** server will automatically supply an **IP address gateway address**, and **subnet mask** to STW-602C. By default, the DHCP client function on STW-602C is disabled, user can activate the DHCP functions by the following steps

- Execute **SerialManager Utility**
- Click on the **IP address** (of STW-602C)
- Click "**Config**" to pop-up the static IP Dialog Window
- Check on "**Auto IP**"
- Click "**Config Now**" (The STW-602C will restart and obtain the IP from the DHCP server automatically)

### 2.7. TCP/IP Port Number

Default Port numbers of STW-602C is **4660** (1<sup>st</sup> port) & **4661** (2<sup>nd</sup> Port) and it is associated with the serial port **COM1** and **COM2** respectively. After the application program connected to the TCP port 4660 (or 4661) on the STW-602C, data of user's application program are transmitted transparently to STW-602C and vice versa.



the Virtual COM driver redirects communications from the virtual COM port to the destination IP address (and the designated port number) by encapsulated COM data into IP data. **Fig 5.** illustrates a Virtual COM connection diagram.

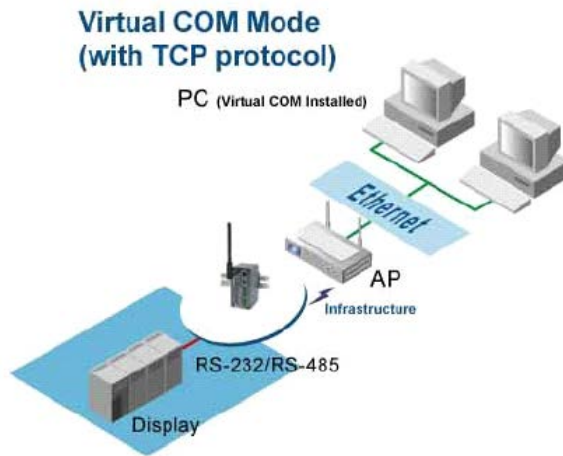

**Fig 5. TCP Connection in Virtual COM Mode**

### TCP Server in Virtual COM Mode

STW-602C can be configured in the TCP server mode (PC as a client) with a unique IP and Port number, and STW-602C waits passively for the PC to establish a connection to. After the connection is established, PC can communicate to serial devices through STW-602C.

### Configure STW-602C to be TCP server

Using one of the three configuration methods (Telnet, Web, and console), User can configure STW-602C to be as TCP Server as following.

- Disabled the IP filter (default)
- Set the port number (default port is 4660 for COM1, 4661 for COM2).
- If IP filter is enabled, only the assigned source IP is allowed to be connected to STW-602C.

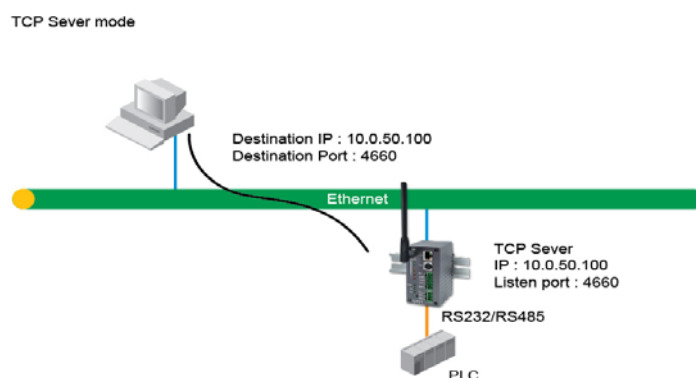

**Fig 6. TCP Server in Virtual COM Mode**

### TCP Client in Virtual COM Mode

STW-602C can be configured to be TCP Client mode (PC as a server) to establish a TCP connection to an application server on PC, or the Remote Control Host. Once the connection is established, PC or Remote Control Host can exchange data with several serial devices at the same time through STW-602C.

### Configuring STW-602C to be TCP client

User can configure STW-602C to be as TCP Client for example, from **Fig. 7**. PC, as a server, has IP address 10.0.0.100 and listening on port 1000. Each STW-602C, connected with serial device, configured as TCP client mode with destination IP address 10.0.0.100 and the destination port 1000, and the IP filter is disabled (by default).

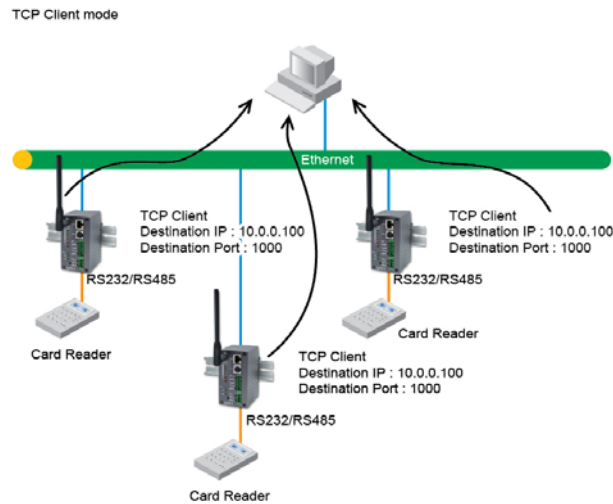
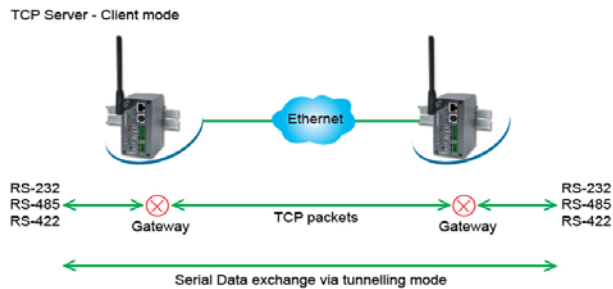

**Fig 7. TCP Client in Virtual COM Mode**

### 3.2.2. Tunneling Mode

Tunneling Mode is used for multiple serial devices to “talk” among one another through STW-602C’s wireless LAN or wired Ethernet. This mode is particularly useful when two or more serial devices are far away. This mode can be used to extend the normal serial communication distance of 15 m to 100 m or longer.

One STW-602C can be configured to be the TCP Server Mode with serial device connected and also another STW-602C is configured as TCP client with serial device connected. After the connection is established, both serial devices can exchange data to each other transparently. For example, User can implement STW-602C tunneling mode for Master /Slave mode PLCs or between other serial devices.



**Fig 8. TCP Link in Tunneling mode**

### Configuring STW-602C to Tunneling Mode

Using one of three configuration methods (Telnet, Web, or Console), user can configure STW-602C to TCP Server mode with a desired IP address and port, and with other STW-602C is configured as TCP Clients mode with Server IP and port as destination IP and port respectively.

※ **Note: TCP client has to assign the destination IP and the destination port corresponding to TCP server’s IP and listening port (example: TCP 4660 port).**

※

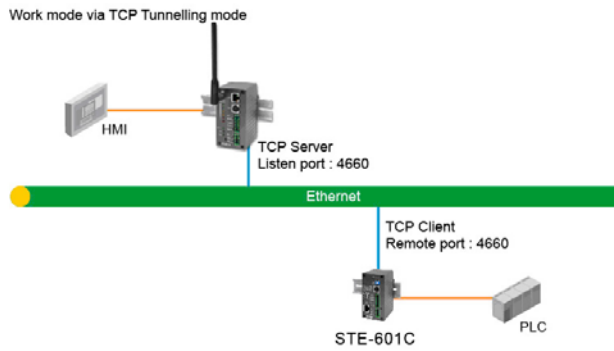

**Fig 9. TCP Tunneling Mode**

## UDP

In UDP mode, User may exchange Multicast data from one STW-602C with multiple STW-602Cs, Vice versa is also true.

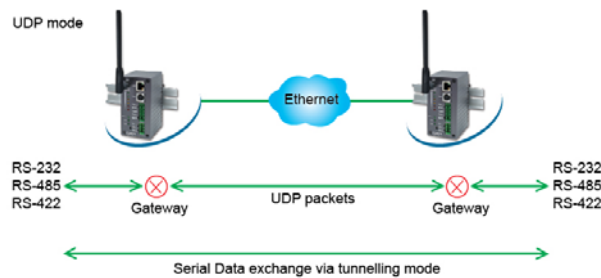

**Fig 10. UDP Link in Tunneling mode**

## Configure STW-602C in UDP Mode

Use one of the three configuration methods (Telnet, Web, and console). User can configure STW-602C to UDP mode. In UDP mode, STW-602C can be configured to communicate to more than one node (Multicasting). Note that the **Multicast** IP address is limited by the Class of IP address and subnet mask. As an example, for a network of Class C of subnet 192.168.1.X and a subnet mask of 255.255.255.0, the maximum Multicast IP address to be configured is **four** destinations IP's.

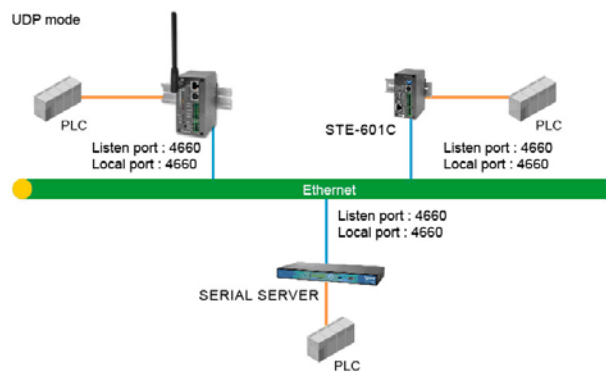

**Fig 11. Multi-UDP Link in Tunneling Mode**

## 4. Configure STW-602C by web interface

User has to assign IP address to STW-602C before working on web configuration operations. Please refer to [section 3.2](#) for more detail.

### 4.1. Login to System

Open one of the web browsers, ex. Microsoft IE or Firefox etc. Enter the IP address of STW-602C on the URL. **Example:** <http://10.0.50.100> or <http://user-device-IP>

The following authentication screen shall appear. Enter **user name** and **password** then click on “OK”. The default user name is **admin** and password is **null** (leave it blank).



**Fig 12. Authorization request for system security**

The overview screen shall appear (**Fig. 13**).

### 4.2. General Information

This system overview window gives the general information on STW-602C, included Network, and Serial information.

## Devolinx Ethernet-Serial Server

### Overview

The general device information of Ethernet-Serial Server.

Device Information	
Model Name	STW-602C
Device Name	0060e9035aa9
Kernel Version	1.16
AP Version	1.37

Network Information		
LAN	MAC Address	00:60:E9:03:5A:A9
	IP Address	192.168.1.160
WLAN	MAC Address	00:1D:7D:30:03:17
	Region	America
	IP Address	192.168.1.161
	Status	2WIRE019 00:12:88:98:2E:09  100%

COM 1 Information	
Serial Interface	RS-232
Link Mode	TCP Server
Baud Rate	9600
Parity	None
Data bits	8
Stop bits	1
Flow Control	None
Link Status	SERVER MODE: Listening[0]

COM 2 Information	
Serial Interface	RS-232
Link Mode	TCP Server
Baud Rate	9600
Parity	None
Data bits	8
Stop bits	1
Flow Control	None
Link Status	SERVER MODE: Listening[0]

Link Status: [N] is the session number connected.  
It's [0] when the link is connecting or listening.

Copyright (c) Aaxeon Technologies, Inc. All rights reserved. Copyright(c) ATOP All right reserved.

Fig 13. Overview for system information by Web Interface

### Device Information

STW-602C's system information includes **model name**, **Device Name**, **Kernel version** and **AP version**. The information is read only and is attributed from another setting page or system status



Device Information	
Model Name	STW-602C
Device Name	0060e9035aa9
Kernel Version	1.16
AP Version	1.37

Fig 14. Device Information from Overview web page

## Networking information

Networking information fields are displayed both 'LAN & Wireless LAN (WLAN) Information. The information provided LAN MAC address, LAN IP address, WLAN MAC address, WLAN IP address and WLAN status

Network Information		
LAN	MAC Address	00:60:E9:03:5A:A9
	IP Address	192.168.1.160
WLAN	MAC Address	00:1D:7D:30:03:17
	Region	America
	IP Address	192.168.1.161
	Status	2WIRE019 00:12:88:98:2E:09  100%

Fig 15. Network Information from Overview web page

## Serial Information

STW-602C COM1 (COM2) information includes **UART mode, link mode, baud rate, parity, data bits, stop bits, flow control and link status**. The COM1 (COM2) information is read only and is attributed from Serial settings of COM1 or COM2 Port of STW-602C.

COM 1 Information	
Serial Interface	RS-232
Link Mode	TCP Server
Baud Rate	9600
Parity	None
Data bits	8
Stop bits	1
Flow Control	None
Link Status	SERVER MODE: Listening[0]

Fig 16. Serial Information from Overview web page

### 4.3. Network Configurations

There are four items allowed to change on Network page, included **LAN**, **WLAN**, **DNS** and **SNMP** Information.

Devolinx Ethernet-Serial Server

#### Networking

**TCP/IP**  
To configure network settings of Serial Server. After saving configuration you have to restart the device to make the settings effective.

LAN Settings				
DHCP	<input type="checkbox"/> Obtain IP automatically			
IP Address	192	168	1	160
Subnet Mask	255	255	255	0
Default Gateway	192	168	1	1

WLAN Settings				
DHCP	<input type="checkbox"/> Obtain IP automatically			
IP Address	192	168	1	161
Subnet Mask	255	255	255	0
Default Gateway	192	168	1	1

**DNS**

DNS Settings				
DNS1	192	168	1	1
DNS2	0	0	0	0

**SNMP**  
By enabling SNMP you allow the management utility to collect the information of Serial Server. You can change the device network identity as well by changing the system name, location and contact.

SNMP Settings	
SNMP	<input checked="" type="checkbox"/> Enable SNMP
SysName	<input type="text" value="0060E9-035AA9"/>
SysLocation	<input type="text" value="location"/>
SysContact	<input type="text" value="contact"/>
Read Community	<input type="text" value="public"/>
Write Community	<input type="text" value="private"/>
SNMP Trap Server	<input type="text" value="0"/> <input type="text" value="0"/> <input type="text" value="0"/> <input type="text" value="0"/>
Alert Event	<input type="checkbox"/> Cold Start <input type="checkbox"/> Warm Start <input type="checkbox"/> Link Down <input type="checkbox"/> Link Up <input type="checkbox"/> Authentication Failure

Fig 17. Network information by Web page

### 4.3.1. LAN Settings

Operation: [Network] → [LAN Setting]

Click on the “**Network**” link and the following screen shall appear. Fill in IP information on TCP/IP field. Alternatively, click on DHCP to automatically obtain **IP address**, **gateway** and **subnet mask** information.

LAN Settings				
DHCP	<input type="checkbox"/> Obtain IP automatically			
IP Address	192	168	1	160
Subnet Mask	255	255	255	0
Default Gateway	192	168	1	1

Fig 18. LAN Setting from Network web page

### 4.3.2. WLAN Settings

Operation: [Network] → [WLAN Settings]

Click on the “**Network**” link Mode and the following screen shall appear. Fill in **WLAN IP** information on WLAN settings fields. Alternatively, User may activate DHCP client function by checking on “**Obtain an IP automatically**” field to automatically obtain **IP address**, **gateway** and **subnet mask** from DHCP server.

WLAN Settings				
DHCP	<input type="checkbox"/> Obtain IP automatically			
IP Address	192	168	1	161
Subnet Mask	255	255	255	0
Default Gateway	192	168	1	1

Fig 19. WLAN Setting from Network web page

### 4.3.3. DNS Settings

Operation: [Network] → [DNS Settings]

Click on the “**Network**” link and the following screen shall appear. Fill in DNS information on **DNS Settings** field. Alternatively, User can configure DNS by checking on “**Obtain an IP automatically**” field in **LAN Settings** or **WLAN Settings** fields to automatically obtain DNS from DHCP server.

DNS Settings				
DNS1	192	168	1	1
DNS2	0	0	0	0

Fig 20. DNS Setting from Network web page

### 4.3.4. SNMP Settings

**Operation: [Network] → [SNMP Settings]**

Click on the **“Network”** link and the following screen shall appear. Check on **“Enabling Settings”** field. Fill in desired **SysName**, **SysLocation**, **SysContact** information on SNMP Settings fields. The changes of SNMP Settings will take effect only after the STW-602C restarted.

SNMP Settings	
SNMP	<input checked="" type="checkbox"/> Enable SNMP
SysName	0060E9-035AA9
SysLocation	location
SysContact	contact
Read Community	public
Write Community	private
SNMP Trap Server	0 0 0 0
Alert Event	<input type="checkbox"/> Cold Start <input type="checkbox"/> Warm Start <input type="checkbox"/> Link Down <input type="checkbox"/> Link Up <input type="checkbox"/> Authentication Failure

**Fig 21. SNMP Setting from Network web page**

**4.4. Wireless Configuration**

There are three fields of information on Wireless Configuration page which are Default, Current and Site-Survey Information. Click on **“Wireless”** link and the following screen shall appear.

**Devolinx Ethernet-Serial Server**

**Wireless**

There are three buttons in this page.  
 "Rescan": Search wireless AP.  
 "Select" : Start to connect or Change to default.  
 "User Define": Set wireless manually.

Default Information						
SSID	BSSID (AP MAC)	Topology	TxRate	Channel	Encryption	IP Address
(Any)	FF:FF:FF:FF:FF:FF	Infrastructure	54.0 Mb/s	Auto	None	192.168.1.161

Current Information						
SSID	BSSID (AP MAC)	Topology	TxRate	Channel	Encryption	Status
2WIRE019	00:12:88:98:2E:09	Infrastructure	54.0 Mb/s	6	WEP	<div style="display: flex; align-items: center;"> <div style="width: 20px; height: 10px; background-color: #00ff00; margin-right: 5px;"></div> <div style="width: 20px; height: 10px; background-color: #00ff00; margin-right: 5px;"></div> <div style="width: 20px; height: 10px; background-color: #00ff00; margin-right: 5px;"></div> <div style="width: 20px; height: 10px; background-color: #00ff00; margin-right: 5px;"></div> <span>100%</span> </div>

Region: [ Americas ] Wireless Band Mode: [ BG Mixed ]						
Select	SSID	BSSID (AP MAC)	Topology	Channel	Encryption	Strength%
<input checked="" type="radio"/>	(Any)	(Any)	Infrastructure	1	None	None

**Fig 22. Wireless information by Web page**

There are 3 buttons can be operated on Wireless page

- **Rescan:** Click on the “**Rescan**” button, and STW-602C will start site-survey procedures, then on the site-survey list will display the access points founded.
- **Select:** On the site-survey list, click on radio button to attach the access point you wanted
- **User defined:** Users can also define information for wireless parameters by themselves.

#### 4.4.1. Wireless Detail Settings

User can configure wireless LAN parameters through web pages. Pop-up windows page will be shown for advanced wireless settings if “**select**” or “**user define**” button was clicked (**FIG. 23**). For example, User can configure **SSID**, **wireless topology**, **Wireless Band Mode**, **TxRate**, **Channel**, **Authentication**, and **Encryption** of the access point that STW-602C want to connect to.

The advanced wireless settings also include roaming threshold. User can configure roaming signal threshold for the STW-602C. STW-602C will change to the stronger wireless signal access point, if the original access point’s signal is less than roaming threshold.

Wireless Setting	
Roaming Threshold (%dBm)	<input type="radio"/> Low (25%/-80) <input checked="" type="radio"/> Normal (50%/-70) <input type="radio"/> High (75%/-60)
SSID	AAXEON
BSSID (AP MAC)	<input type="text"/> <input type="checkbox"/> Enable
Topology	Infrastructure Mode
Wireless Band Mode	BG Mixed
TxRate	Auto
Channel	1
Authentication	Open
Encryption	None
WPA-PSK ( 8 ~ 63 ASCII or 64 HEX )	<input type="text"/>
WEP Key1	Hexadecimal 64bits <input type="text"/>
WEP Key2	Hexadecimal 64bits <input type="text"/>
WEP Key3	Hexadecimal 64bits <input type="text"/>
WEP Key4	Hexadecimal 64bits <input type="text"/>

Fig 23. Pop-up Windows for Wireless Detail settings

#### 4.4.2. Sample Wireless Application Cases

Below are some screen shot examples of **wireless detail settings** for different wireless security schemes.

##### Attach access point without Authorization

- **Topology:** Infrastructure
- **Channel:** Auto-assignment from Access point
- **Authentication:** open
- **Encryption:** None

Wireless Setting	
Roaming Threshold (%/dBm)	<input type="radio"/> Low (25%/-80) <input checked="" type="radio"/> Normal (50%/-70) <input type="radio"/> High (75%/-60)
SSID	AAXEON
BSSID (AP MAC)	<input type="text"/> <input type="checkbox"/> Enable
Topology	Infrastructure Mode
Wireless Band Mode	BG Mixed
TxRate	Auto
Channel	1
Authentication	Open
Encryption	None
WPA-PSK ( 8 ~ 63 ASCII or 64 HEX )	<input type="text"/>
WEP Key1	Hexadecimal 64bits <input type="text"/>
WEP Key2	Hexadecimal 64bits <input type="text"/>
WEP Key3	Hexadecimal 64bits <input type="text"/>
WEP Key4	Hexadecimal 64bits <input type="text"/>

Fig 24. Open Authorization and no Encryption

### Attach access point with WEP

- **Topology:** Infrastructure
- **Channel:** Auto-assignment from Access point
- **Authentication:** share
- **Encryption:** WEP
- **WEP Key1~4:** Hexadecimal or ASCII / 64 or 128bit / <WEP Key>

Wireless Setting	
Roaming Threshold (%/dBm)	<input type="radio"/> Low (25%/-80) <input checked="" type="radio"/> Normal (50%/-70) <input type="radio"/> High (75%/-60)
SSID	AAXEON
BSSID (AP MAC)	<input type="text"/> <input type="checkbox"/> Enable
Topology	Infrastructure Mode
Wireless Band Mode	BG Mixed
TxRate	Auto
Channel	1
Authentication	Shared
Encryption	WEP
WPA-PSK ( 8 ~ 63 ASCII or 64 HEX )	<input type="text"/>
<input checked="" type="radio"/> WEP Key1	Hexadecimal 64bits 0123456789
<input type="radio"/> WEP Key2	Hexadecimal 64bits <input type="text"/>
<input type="radio"/> WEP Key3	Hexadecimal 64bits <input type="text"/>
<input type="radio"/> WEP Key4	Hexadecimal 64bits <input type="text"/>

Fig 25. Share Authorization and WEP Encryption

- \* **Note1:** Enter 5 ASCII value or 10 Hexadecimal digit if select WEP64 encryption.
- \* **Note2:** Enter 13 ASCII value or 26 Hexadecimal digit if select WEP128 encryption

### Attach access point with WPA-PSK

- **Topology:** Infrastructure
- **Channel:** Auto-assignment from Access point

- **Authentication:** WPA-PSK
- **Encryption:** TKIP or AES
- **WPA-PSK:** 8~ 63 Characters

Wireless Setting	
Roaming Threshold (%dBm)	<input type="radio"/> Low (25%/-80) <input checked="" type="radio"/> Normal (50%/-70) <input type="radio"/> High (75%/-60)
SSID	AAXEON
BSSID (AP MAC)	<input type="text"/> <input type="checkbox"/> Enable
Topology	Infrastructure Mode
Wireless Band Mode	BG Mixed
TxRate	Auto
Channel	1
Authentication	WPA-PSK
Encryption	TKIP
WPA-PSK ( 8 ~ 63 ASCII or 64 HEX )	01234567
WEP Key1	Hexadecimal 64bits
WEP Key2	Hexadecimal 64bits
WEP Key3	Hexadecimal 64bits
WEP Key4	Hexadecimal 64bits

Fig 26. WPA-PSK Authorization and TKIP Encryption

#### 4.5. COM Port Configuration

Here User can configure **Serial parameters**, include alias, baud rate, parity, data bit and type of flow control defined by user.

**Devolinx Ethernet-Serial Server**

**COM 1**

To choose specific working mode for COM 1 port.

TCP Server   
 TCP Client   
 UDP

TCP Server	
Virtual COM	<input type="checkbox"/> Enable
IP Filter	<input type="checkbox"/> Enable
Source IP	<input type="text" value="0"/> <input type="text" value="0"/> <input type="text" value="0"/> <input type="text" value="0"/>
Local Port	<input type="text" value="4660"/>
Connect Number Limit	<input type="text" value="1"/>

To configure COM 1 port parameters.

Serial Settings	
Serial Interface	<input checked="" type="radio"/> RS232 <input type="radio"/> RS422 <input type="radio"/> RS485
Baud Rate	<input type="text" value="9600"/> bps
Parity	<input checked="" type="radio"/> None <input type="radio"/> Odd <input type="radio"/> Even <input type="radio"/> Mark <input type="radio"/> Space
Data bits	<input type="radio"/> 5 bits <input type="radio"/> 6 bits <input type="radio"/> 7 bits <input checked="" type="radio"/> 8 bits
Stop bits	<input checked="" type="radio"/> 1 bit <input type="radio"/> 2 bits
Flow Control	<input checked="" type="radio"/> None <input type="radio"/> Xon/Xoff <input type="radio"/> RTS/CTS
Packet Delimiter (Network to Serial)	<input type="checkbox"/> Enable Timer <input type="text" value="10"/> (10~30000) ms Characters <input type="text" value="0x0d0a"/> ("0x"+ASCII Code, Ex. 0x0d or 0x0d0a)
Packet Delimiter (Serial to Network)	<input type="checkbox"/> Enable Timer <input type="text" value="10"/> (10~30000) ms Characters <input type="text" value="0x0d0a"/> ("0x"+ASCII Code, Ex. 0x0d or 0x0d0a)

Packet Delimiter: Collect data into single packet for reduce overhead.

**Fig 27. COM port Information Web Page**

#### 4.5.1. Link Mode Settings

- Click on the “**Serial**” link and the **Fig. 27** screen will appear.
- Fill in Serial parameter information on **Serial Settings** field
- Click on “**Save Configuration**” button to save the changes.

#### 4.5.2. TCP Server Mode

**TCP Server** mode is default Link mode of **Serial Settings**, and it can wait for connecting requirement from remote host PC which running “serial-to IP” utility or setting STW-602Cs in tunneling mode. User has to configure listening port to allow client establish connection to this server. Default port number of STW-602C is 4660.

**IP filtering** function is a simple **ACL** (Access Control List). It can be disabled by setting FILTER\_IP to “0.0.0.0”.

User can configure one or group IP for **source IP**. If IP filter is enabled, only source IP assigned can be connected to STW-602C



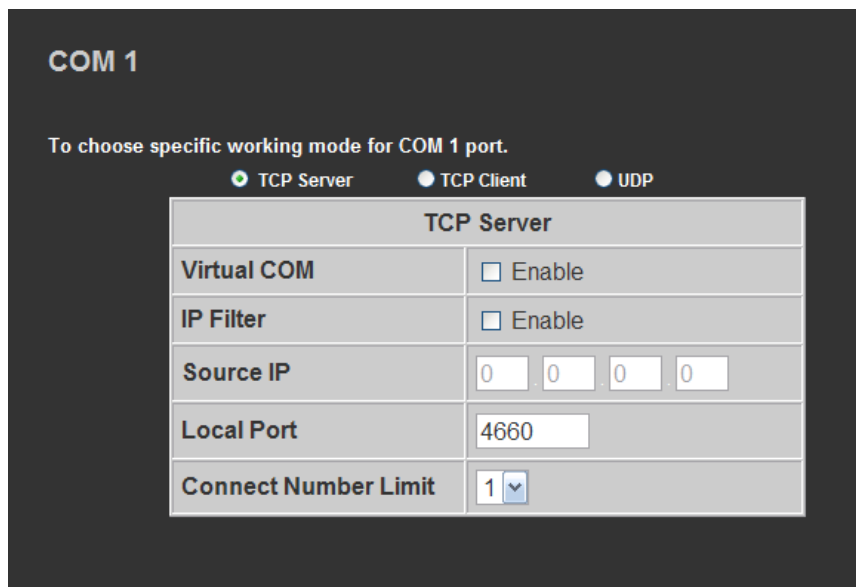

Fig 28. TCP Server in Link mode

\* Note: Enable Virtual COM mode if the remote site PC's "Serial to IP" tool is installed

### 4.5.3. TCP Client Mode

User may enter destination IP & port (default: 4660) to establish connection of counter-pair (remote) host (For example, another STW-602C, or PC for data-collection). STW-602C can support two destination hosts simultaneously.

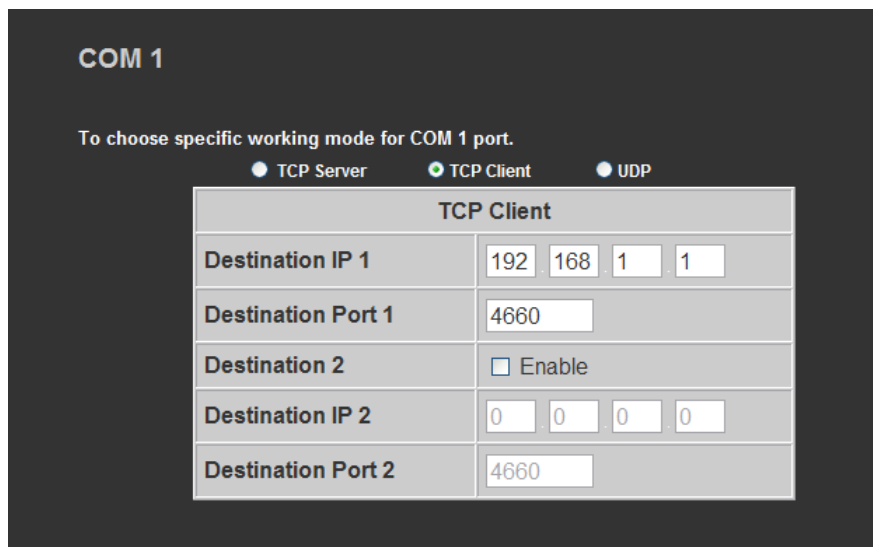

Fig 29. TCP Client in Link mode

### 4.5.4. UDP Mode

STW-602C can be configured in a **UDP mode** to establish connection using **Unicast** or **Multicast** data from the serial device to one or multiple host computers. Vice versa is also true. For example, the original **RS-422/ RS485** bus can be transferred and extended connected distance by STW-602Cs.

The destination IP is assigned by single IP or group IPs, The configuration is limited by the Local Listening Port. For example, on STW-602C listening port is 4660 which receive data sending from the host computers. STW-602C can support up to **4-group** IPs for UDP connection, if users needed.

**COM 1**

To choose specific working mode for COM 1 port.

TCP Server   
 TCP Client   
 UDP

UDP	
Local Port	4660
Destination IP Address 1	<input checked="" type="checkbox"/> Enable    192 168 1 26 ~ 50    Port 4660
Destination IP Address 2	<input checked="" type="checkbox"/> Enable    192 168 2 51 ~ 75    Port 4661
Destination IP Address 3	<input checked="" type="checkbox"/> Enable    192 168 3 76 ~ 100    Port 4662
Destination IP Address 4	<input type="checkbox"/> Enable    0 0 0 0 ~ 0    Port 4660

**Fig 30. UDP protocol in Link mode**

\* **Note:** In this phase, UDP mode does not support Virtual COM mode.

### 4.5.5. Serial Settings

This field can be configured with serial parameters for STW-602C. Here User can configure Serial parameters, include **UART Mode**, **baud rate**, **parity**, **data bit** and **type of flow control**.

- **Configure UART Mode:** RS-232 or RS-485 or RS-422
- **Baud rate:** 1200/2400/4800/9600/19200/38400/57600/115200
- **Parity:** None or Odd or Even or Mark or Space
- **Data bits:** 7 or 8
- **Stop bits:** 1 or 2
- **Flow control:** None or Xon/Xoff or Hardware (RTS/CTS).

Serial Settings	
Serial Interface	<input type="radio"/> RS232 <input checked="" type="radio"/> RS422 <input type="radio"/> RS485
Baud Rate	115200 bps
Parity	<input checked="" type="radio"/> None <input type="radio"/> Odd <input type="radio"/> Even <input type="radio"/> Mark <input type="radio"/> Space
Data bits	<input type="radio"/> 5 bits <input type="radio"/> 6 bits <input type="radio"/> 7 bits <input checked="" type="radio"/> 8 bits
Stop bits	<input checked="" type="radio"/> 1 bit <input type="radio"/> 2 bits
Flow Control	<input checked="" type="radio"/> None <input type="radio"/> Xon/Xoff <input type="radio"/> RTS/CTS
Packet Delimiter (Serial to Network)	<input type="checkbox"/> Enable Timer: 10 (10~30000) ms Characters: 0x0d0a ("0x"+ASCII Code, Ex. 0x0d or 0x0d0a)

**Fig 31. Serial Communication Settings from Web Page**

### 4.5.6. Delimiter Settings

#### Packet delimiter

Packet delimiter is a way of controlling the number of packets in a serial communication. It is designed to keep packets in track. STW-602C provides two ways in parameter setting: (1) **Packet delimiter by timer** and (2) **packet delimiter by Character pattern**. By default, packet delimiter timer is 10 ms. the range of

packet delimiter timer is **10** to **30,000** msec. For Character pattern terminator, if “character pattern is selected and a data stream ended with “0x0a04”, then the entire data buffer of the serial device is transmitted.

User can also choose character pattern as the packet delimiter indicated.

## 4.6. Configure System

There are five subsystems for system settings, included **Time**, **WLAN Region**, **Security**, **Set to default** and **Restart**.

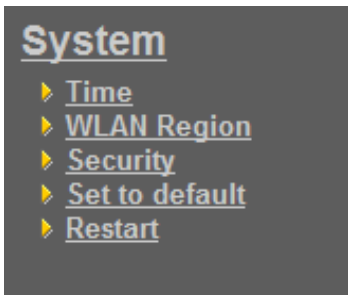

Fig 32. Subsystem menu of system settings Web Interface

### 4.6.1. Configure Time by NTP Service

#### Operation: System→Time

User can set date and time manually by fill in “**Set Date and Time manually**” field. User can also configure **NTP Server** to obtain Network time automatically.

A screenshot of a web page titled "Time". It contains several sections for configuring time services. At the top, it says "By enabling NTP you allow to adjust and set the device internal time, relative to Greenwich Mean Time." Below this is a box for "Current System Time" showing "Fri Jan 6 00:27:55 UTC 2006" and a "Refresh" button. A section for "Local Time Zone Setting" has a checked "Enable NTP" checkbox and a dropdown menu for "Time Zone" set to "(GMT-08:00) Pacific Time (US & Canada); Tijuana". A "Sync with Time Server (NTP)" section has an "NTP Server" field containing "time.nist.gov". A section for "Date and Time Settings" has an unchecked "Enable Manual Setting" checkbox and dropdown menus for "Date" (Year: 2006, Month: Jan, Day: 6) and "Time" (Hour: 0, Minute: 27, Second: 55). A "Save Configuration" button is at the bottom.

Fig 33. Time service settings from System web page

## 4.6.2. WLAN Region

Operation: System->WLAN Region

Click on the “WLAN Region” link and the following screen shall appear (Fig. 34).

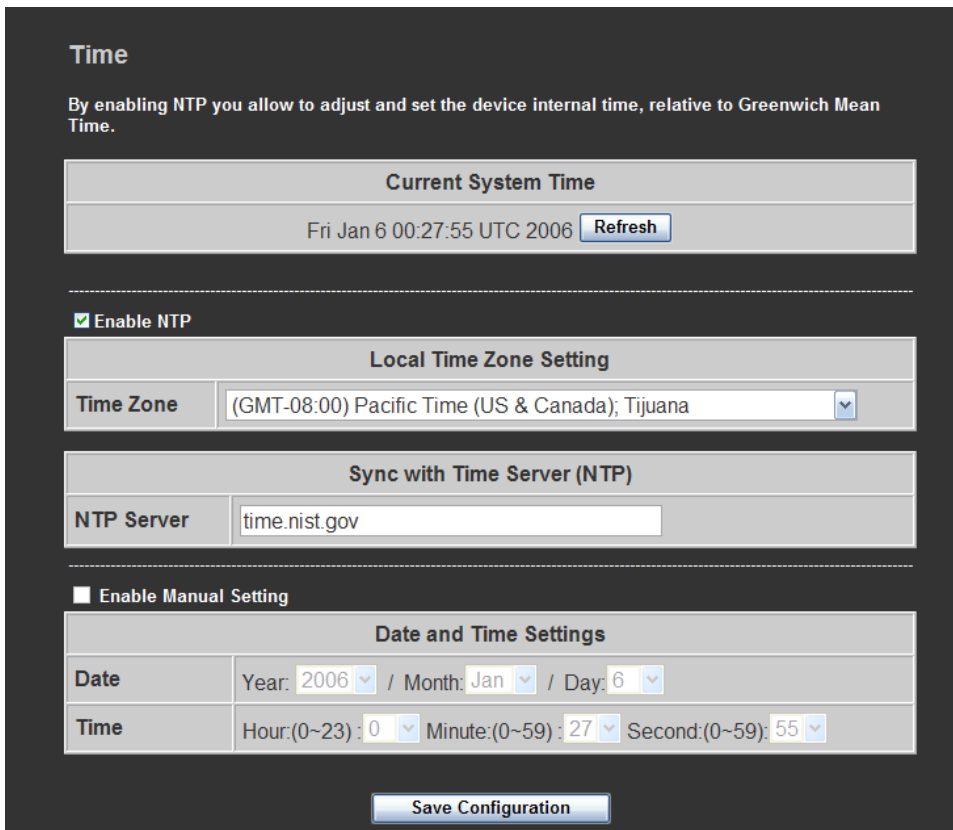
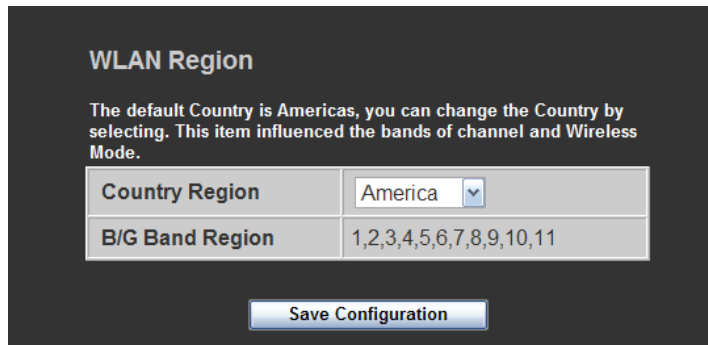

WLAN Region	
The default Country is Americas, you can change the Country by selecting. This item influenced the bands of channel and Wireless Mode.	
Country Region	America
B/G Band Region	1,2,3,4,5,6,7,8,9,10,11
<input type="button" value="Save Configuration"/>	

Fig 34. Time service settings from System web page

Select the country from drop-down list box to country that user wants to implement the STW-602C. This selection will be effected to the bands of channel of STW-602C wireless mode. For example, the normal system level channel configurations for deployments are channels 1, 6 and 11 for FCC countries and 1, 5, 9 and 13 for European Union countries

## 4.6.3. Security (change the Password)

Operation: System->Security

Click on the “Security” link and the following screen shall appear (Fig. 35).

Enter the old password on “Old Password” field then enter the new password on “New Password” and the “Verified Password” fields, and then click on “Save Configuration” to update the password. The maximum is 8 characters.

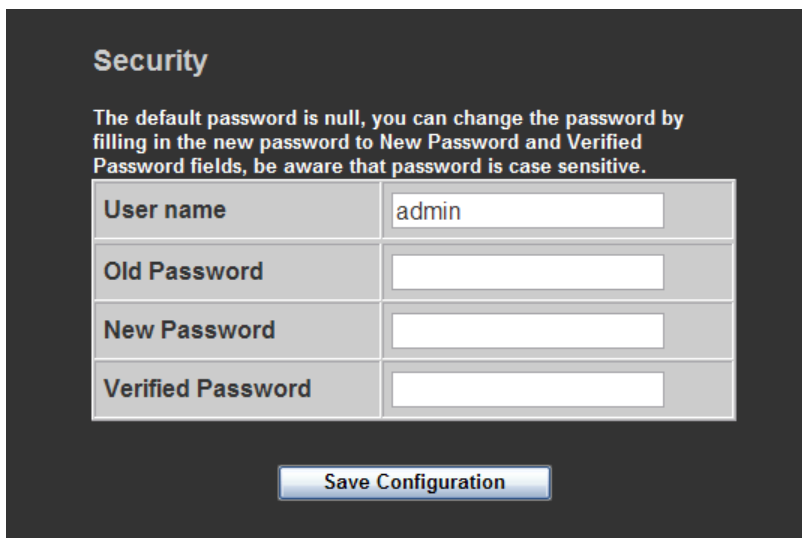

Security	
The default password is null, you can change the password by filling in the new password to New Password and Verified Password fields, be aware that password is case sensitive.	
User name	admin
Old Password	
New Password	
Verified Password	
<input type="button" value="Save Configuration"/>	

Fig 35. Change password from System Security Page

\* Note: User may press the default reset key to reset password to the default value(blank)

#### 4.6.4. Restoring Factory Default Configurations

##### Operation: System→ Set to Default

User can click on “*set to default and restart*” button to restore STW-602C’s settings to factory default (Fig. 36).

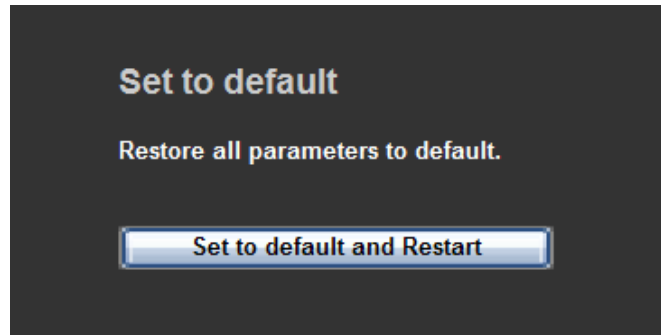

Fig 36. Set all parameters to factory default by Web Interface

#### 4.6.5. Restart System

##### Operation: System→ Restart

The changes of networking parameters will take effect only after the STW-602C is restarted. User can restart the STW-602C manually by click on Restart button on the restart menu web page (Fig 37).

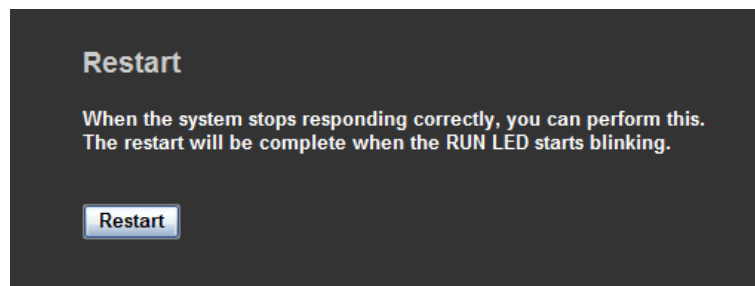
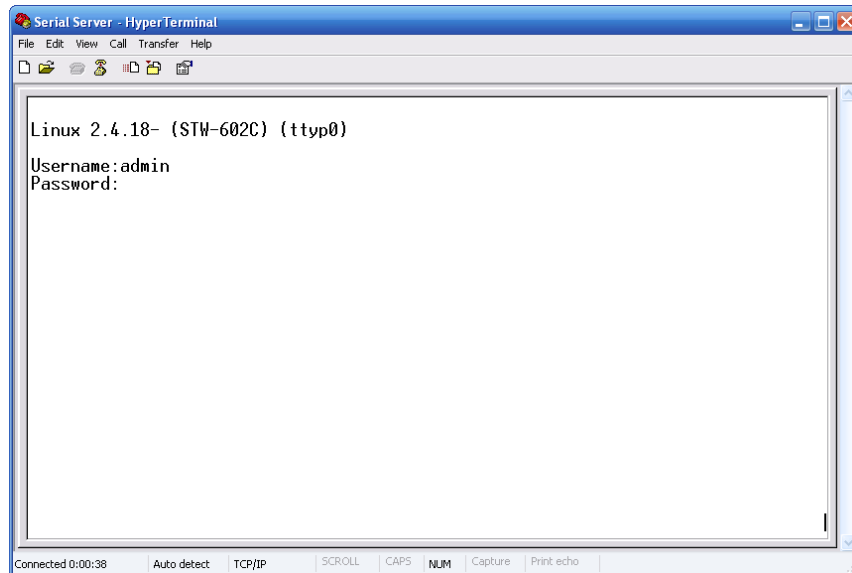

Fig 37. Restart system by Web

## 5. Telnet Configuration

User can also use Telnet utility to change STW-602C configuration settings.

- Open Ms-DOS command prompt window or other telnet tools
- Enter the “**IP address**” of the STW-602C (For example, **Telnet 10.0.50.100**). The system then prompts for username and password, the default username is “**admin**” and the default password is **null (blank)**.



**Fig 38. Login into System by Telnet**

Then the following main menu shall appear

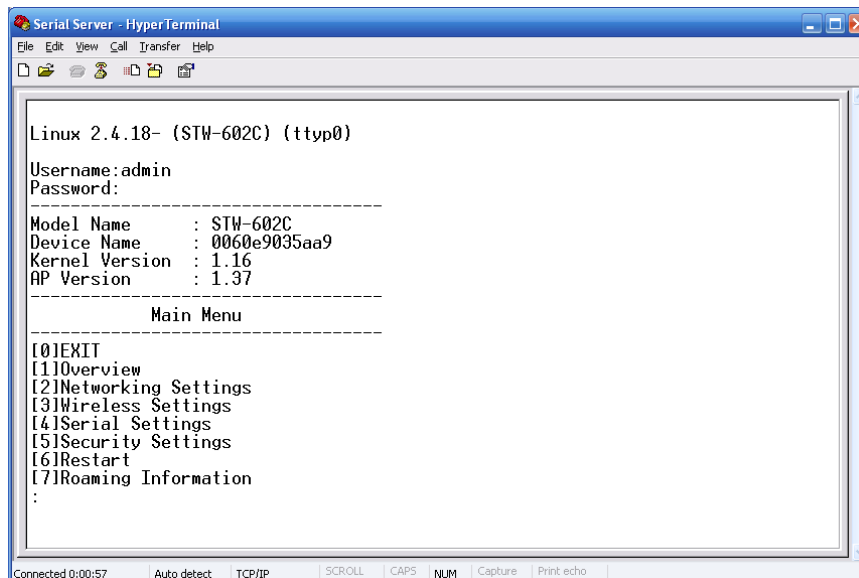

**Fig 39. Overview information by telnet**

- If the STW-602C does not receive any command within **1 minute**, Telnet will be terminated automatically.
- The changes of networking parameters will take effect only after the STW-602C is restarted.

## 5.1. General Information

**Operation:** [Main]→[1 Overview]

Select "1" from "**Input choice (0-6) and enter:**" to enter "**overview page**."

This system overview window gives the general information on **Ethernet & WLAN IP, MAC address, SNMP information, kernel and AP version, and the connection status** of the STW-602C (Fig. 39).

The following overview information shall appear.

### Device Information:

**Model Name:** STW-602C's Model

**Device Name:** [Allows for changes in SNMP settings]

**Kernel Version:** [Read Only, Generated by system]

**AP Version:** [Read Only, Generated by system]

### Ethernet Information:

**MAC:** [Read Only]

**IP:** [Allows for changes in Network Page]

### WLAN Information:

**MAC:** [Read Only]

**IP:** [Allows for changes in Auto IP of Network Page]

**Connected:** [SSID name, if Wireless STW-602C is connected]

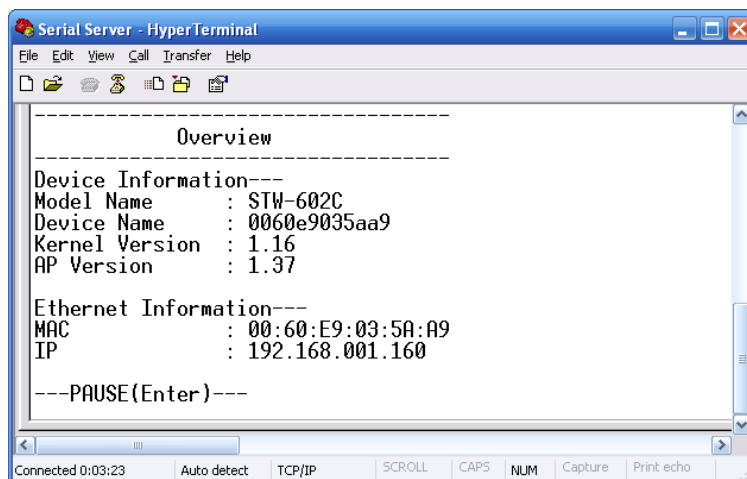

**Fig 40. System Information from Overview**

### DNS Information:

**DNS1:** [IP address of 1<sup>st</sup> DNS Server, Allows for changes in Auto IP of Networking Page]

**DNS2:** [IP address of 2<sup>nd</sup> DNS Server, Allows for changes in Auto IP of Networking Page]

### SNMP Information:

**SNMP Status:** Enable [or Disable, Allows for changes in Networking Page]

**SysName:** [Allows for changes in Networking Page]

**SysLocation:** [Allows for changes in Networking Page]

**SysContact:** Allows for changes in Networking Page]

**Serial Information:**

**UART mode** RS485/RS232/RS422

**Link Mode:** TCP Server [or TCP Client/UDP Mode, Allows for changes in Serial Page]

**Baud rate:** 115200 [or 1200/2400/4800/9600...Allows for changes in Serial Page]

**Parity:** None [or Even/Odd/Space/Mark...Allows for changes in Serial Page]

**Data bits:** 8 [or 7 (bits).Allows for changes in Serial Page]

**Stop bits** 1 bit or 2 bits

**Flow Control** None, Xon/Xoff, RTS/CTS

## 5.2. Networking Configuration

**Operation:** [Main]→[2 Networking]:

Select “2” on “Input choice (0~6) and enter:” to enter **Networking settings** page.

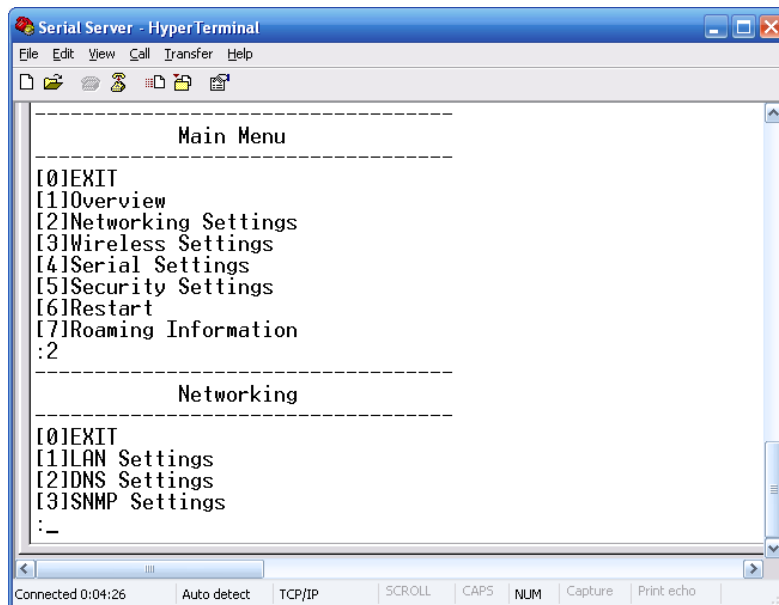

**Fig 41. Networking Settings by Telnet**

✳ **Note:** Press “0” key to return to the previous menu

This section allows for changes in **IP address, subnet mask, gateway IP address and SNMP** information. Please note that setting changes will not take effect until the STW-602C is restarted.



## 5.2.1. LAN Settings

Operation: [Main]→[2 Networking]→[1 LAN Settings]

Select “1” from “*Input choice (0~3) and enter on Networking page.*” to enter **LAN Settings page**. The **MAC address, IP address, subnet mask, gateway address, and IP mode information** will be shown (Fig. 42). User also can set **IP, Netmask, Gateway, and IP mode** of LAN interfaces by enter the corresponding menus and values. For example, **enter 1** for setting the **IP address** on LAN interface.

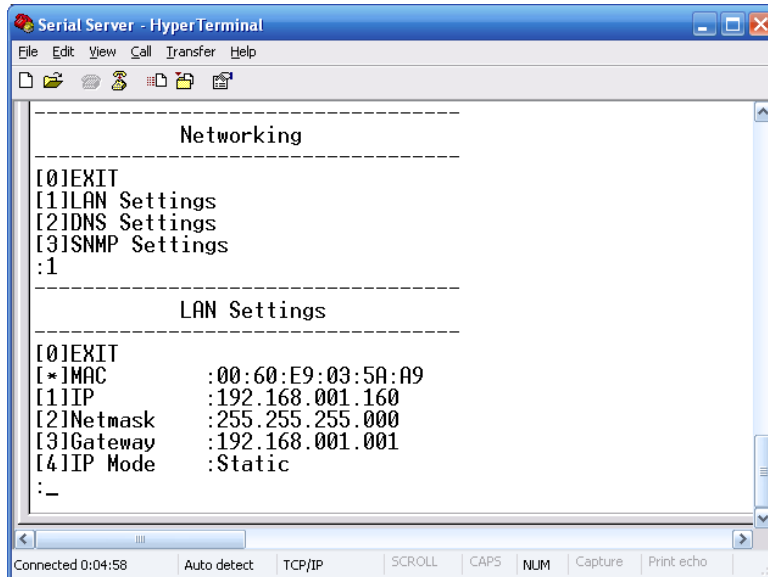

```
Serial Server - HyperTerminal
File Edit View Call Transfer Help
-----
Networking
[0]EXIT
[1]LAN Settings
[2]DNS Settings
[3]SNMP Settings
:1
-----
LAN Settings
[0]EXIT
[*]MAC      :00:60:E9:03:5A:A9
[1]IP       :192.168.001.160
[2]Netmask  :255.255.255.000
[3]Gateway  :192.168.001.001
[4]IP Mode  :Static
:-
-----
Connected 0:04:58  Auto detect  TCP/IP  SCROLL  CAPS  NUM  Capture  Print echo
```

Fig 42. LAN Settings by Telnet

## 5.2.2. DNS Settings

Operation: [Main]→[2 Networking]→[2 DNS Settings]

Select “2” from “*Input choice (0~3) and enter on Networking page.*” to enter **DNS Settings page**. Fill in the DNS information DNS1 or DNS2 or both according to user DNS server (Fig. 43).

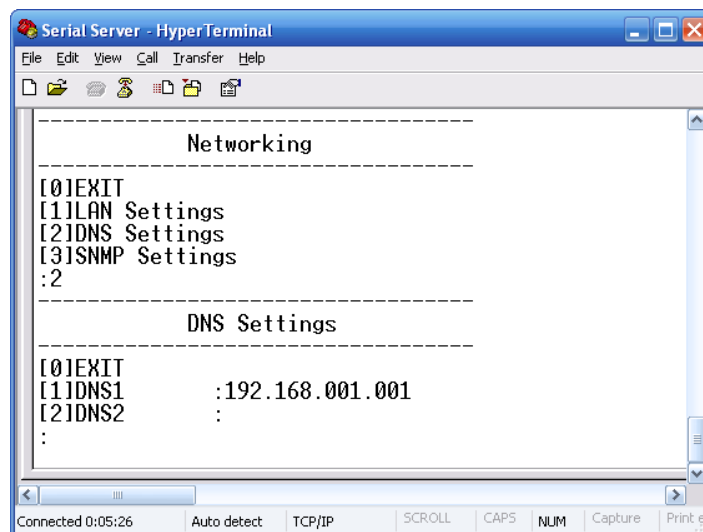

```
Serial Server - HyperTerminal
File Edit View Call Transfer Help
-----
Networking
[0]EXIT
[1]LAN Settings
[2]DNS Settings
[3]SNMP Settings
:2
-----
DNS Settings
[0]EXIT
[1]DNS1     :192.168.001.001
[2]DNS2     :
:
-----
Connected 0:05:26  Auto detect  TCP/IP  SCROLL  CAPS  NUM  Capture  Print e
```

Fig 43. DNS Settings by Telnet

### 5.2.3. SNMP Settings

**Operation:** [Main]→[2 Networking]→[3 SNMP Settings]

Select “3” from “*Input choice (0~3) and enter on Networking page.*” to enter **SNMP Settings page**. User can enable/disable SNMP, and set network identification information on **SNMP Settings page**. The changes will not become effective until STW-602C is restarted

STW-602C basically supports get/set SNMP parameters, these are **SysName** (System Name), **SysLocation** (System Location) and **SysContact** (System Contact). These fields will response and supply basic system information from standard SNMP query. User can set the SNMP system parameters by enter the corresponding menus and values. For example, **enter 2** for changing the **SysName** then enter the desired name.

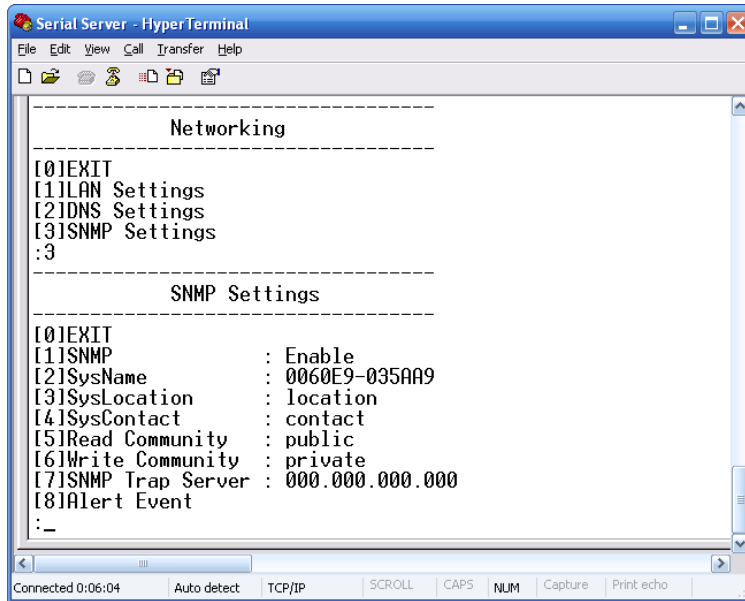

Fig 44. SNMP Settings by Telnet

### 5.3. Wireless Configuration

**Operation:** [Main] → [3 Wireless Settings]

Select “3” from “*Input choice (0~6) and enter.*” the following screen shall appear (Fig. 45).

User can configure wireless **IP**, **Netmask**, **Gateway**, **IP mode**, and **Region** by enter the corresponding menu and corresponding values.

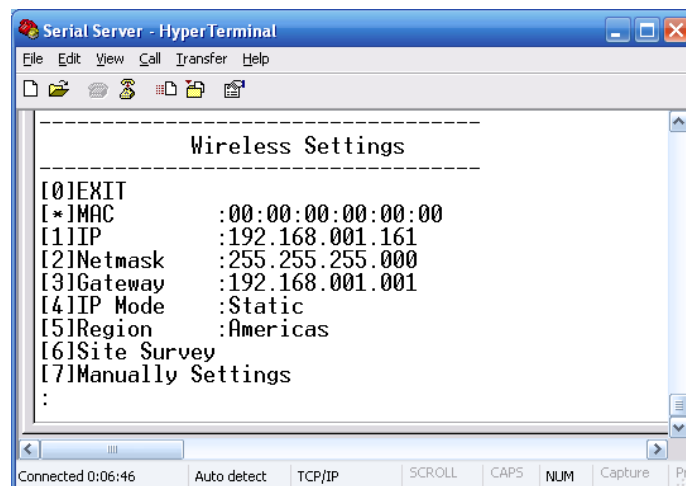

Fig 45. Configure Wireless Settings by Telnet

### 5.3.1. Wireless IP, Netmask, Gateway and IP mode Settings

**Operation:** [Main] → [3 Wireless Settings]→ [1 IP]/[2 Netmask]/ [3 Gateway]/[4 IP Mode]

User can configure STW-602C **Wireless IP/Netmask/Gateway** by enter 1/2/3 at **Wireless Settings** page and enter the desired **IP/Netmask/Gateway** address.

User can also configure **wireless IP mode** by enter 4 at **Wireless Settings** page and enter 1 for **static IP** address or enter 2 for **DHCP** mode (Fig. 47).

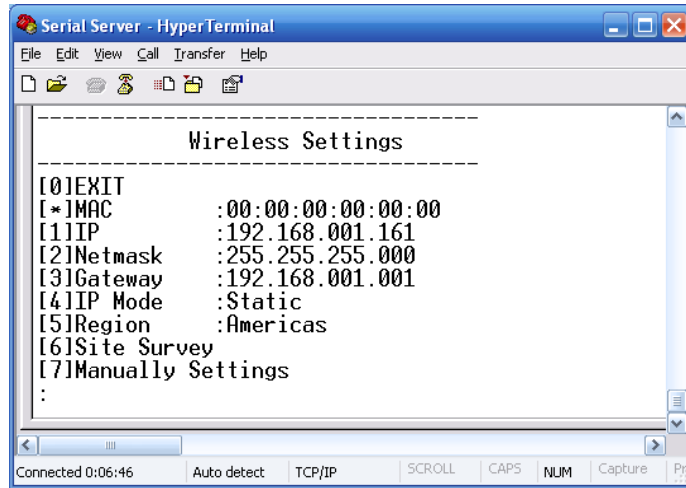

**Fig 46. Configure Wireless Networking by Telnet**

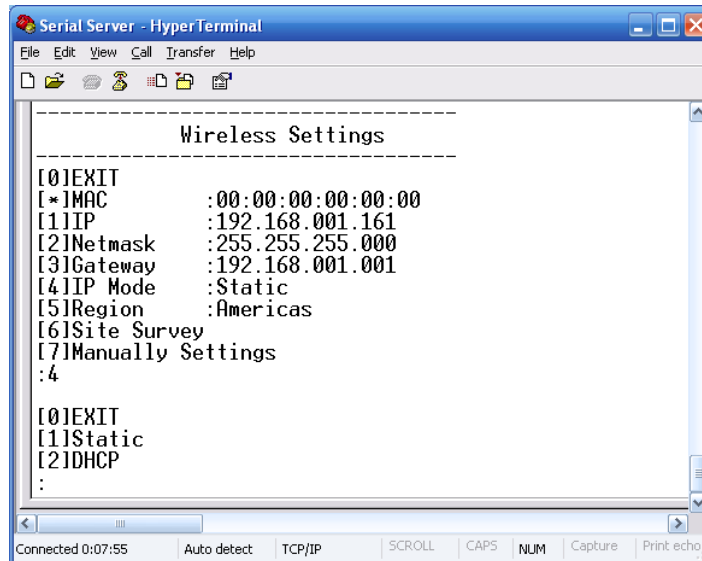

**Fig 47. Configure Wireless IP mode by Telnet**

### 5.3.2. Configure Region

**Operation:** [Main] → [3 Wireless Setting] → [5 Region]

WLAN Region is the geography area that user want to implement the STW-602C. Because the wireless channel implement the frequency band differently in a different regions. User can configure the **WLAN Region** by enter 5 at **Wireless Settings** page and enter the menu according to user's region.

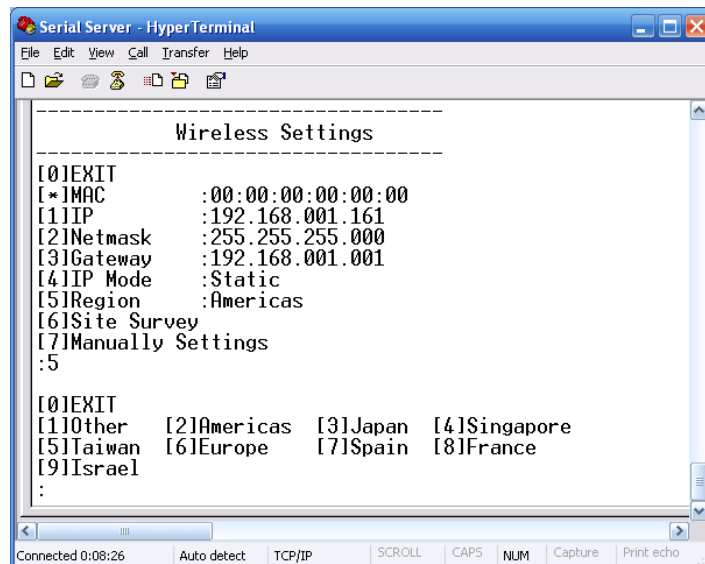

Fig 48. Wireless Region by Telnet

### 5.3.3. Site Survey

Operation: [Main] → [3 Wireless Setting] → [6 Site Survey]

Site survey function can support to auto-assignment wireless parameters, and attached to access point selected automatically. After user do the **site survey** the result of all access points nearby will be displayed (Fig.49). Then user can select the access point that user want STW-602C to be connected to by enter the number of access point (Fig. 50).

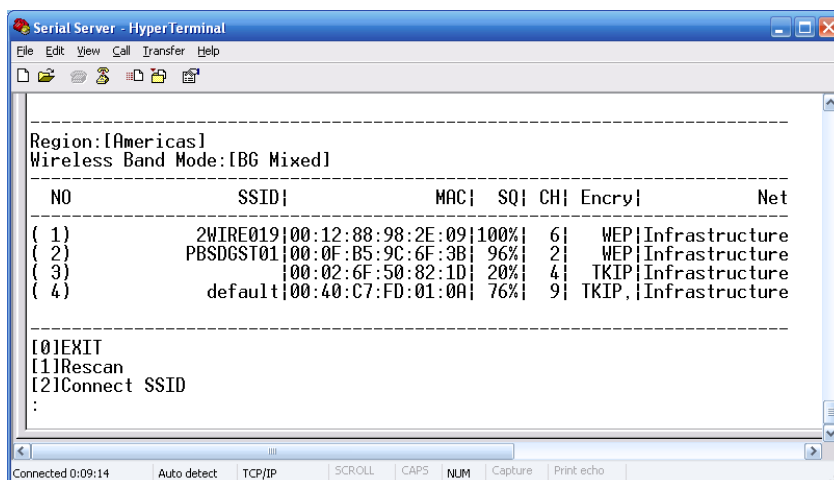

Fig 49. Wireless AP List from Site Survey

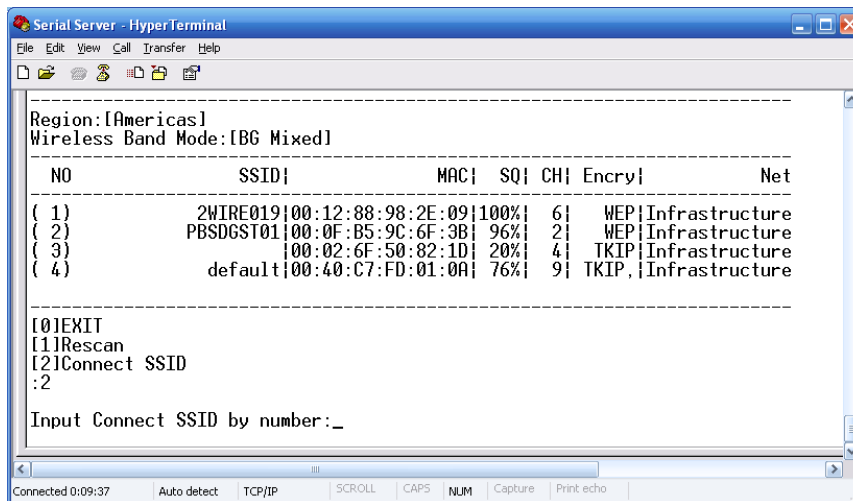

Fig 50. Connected to AP from Site list

### 5.3.4. Manual Wireless Settings

Operation: [Main] → [3 Wireless Setting] → [7 Manually Settings]

User can manually configure STW-602C wireless configurations by enter 7 at the Wireless Settings page. Then user can set any wireless parameters by enter the menu corresponding to that parameters. Wireless parameters are shown in Fig. 51 below.

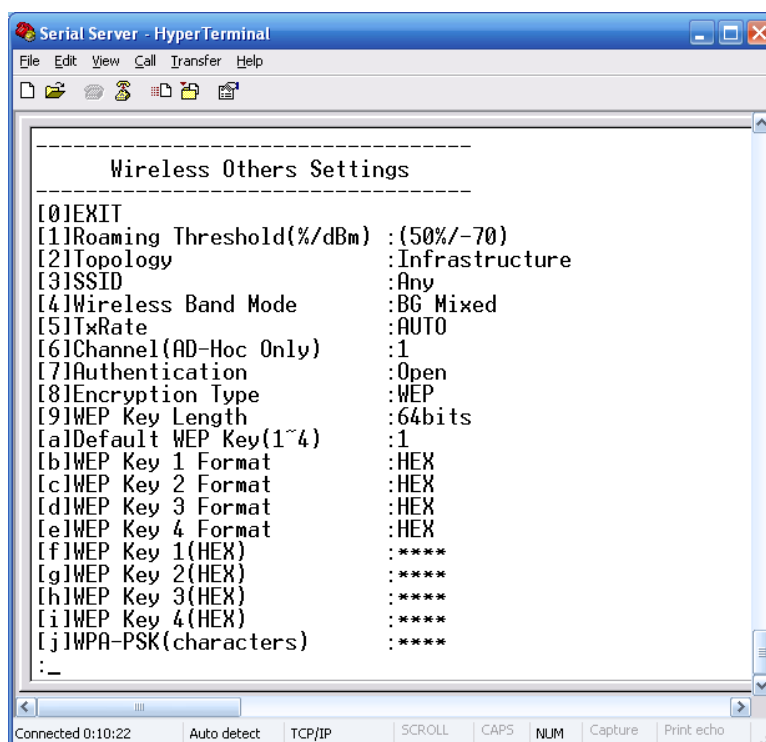

Fig 51. Configure Wireless LAN by Manual

### 5.3.5. Configure Ad-Hoc Mode

Operation: [Main] → [3 Wireless Setting] → [7 Manually Settings] → [2 Topology]

Independent Basic Service Set (IBSS), the most basic type of IEEE 802.11 wireless LAN, is commonly referred to as an ad-hoc network. An IBSS may consist of as few as two stations. Unlike infrastructure mode, all stations are capable of communicating directly with each other without access point.

User can configure Wireless STW-602C to be Ad-Hoc mode, by manually configure the wireless **network topology** as shown in Fig.52 below.

```

Serial Server - HyperTerminal
File Edit View Call Transfer Help

[1]Roaming Threshold(%/dBm) : (50%/-70)
[2]Topology : Infrastructure
[3]SSID : Any
[4]Wireless Band Mode : BG Mixed
[5]TxRate : AUTO
[6]Channel(AD-Hoc Only) : 1
[7]Authentication : Open
[8]Encryption Type : WEP
[9]WEP Key Length : 64bits
[a]Default WEP Key(1~4) : 1
[b]WEP Key 1 Format : HEX
[c]WEP Key 2 Format : HEX
[d]WEP Key 3 Format : HEX
[e]WEP Key 4 Format : HEX
[f]WEP Key 1(HEX) : ****
[g]WEP Key 2(HEX) : ****
[h]WEP Key 3(HEX) : ****
[i]WEP Key 4(HEX) : ****
[j]WPA-PSK(characters) : ****
:2

Network Type
[0]EXIT [1]Infrastructure [2] Adhoc
:_

Connected 0:43:36 Auto detect TCP/IP SCROLL CAPS NUM Capture Print echo

```

**Fig 52. Configure Ad-Hoc mode by Telnet**

User can select wireless link by none or WEP encryption in Ad-hoc mode and these encryptions can support applications from customer's requirements.

## Configure Wireless for WEP

**Operation: [Main] → [3 Wireless Setting] → [7 Manually Settings] → [8 Encryption Type]**

For security reason, Wireless STW-602C can configure to use **WEP key of 40 bits or 128 bits**, or advance **WPA-PSK** to securely communicate in the wireless network. WEP key manually configure via telnet screen is shown as **Fig. 53** below.

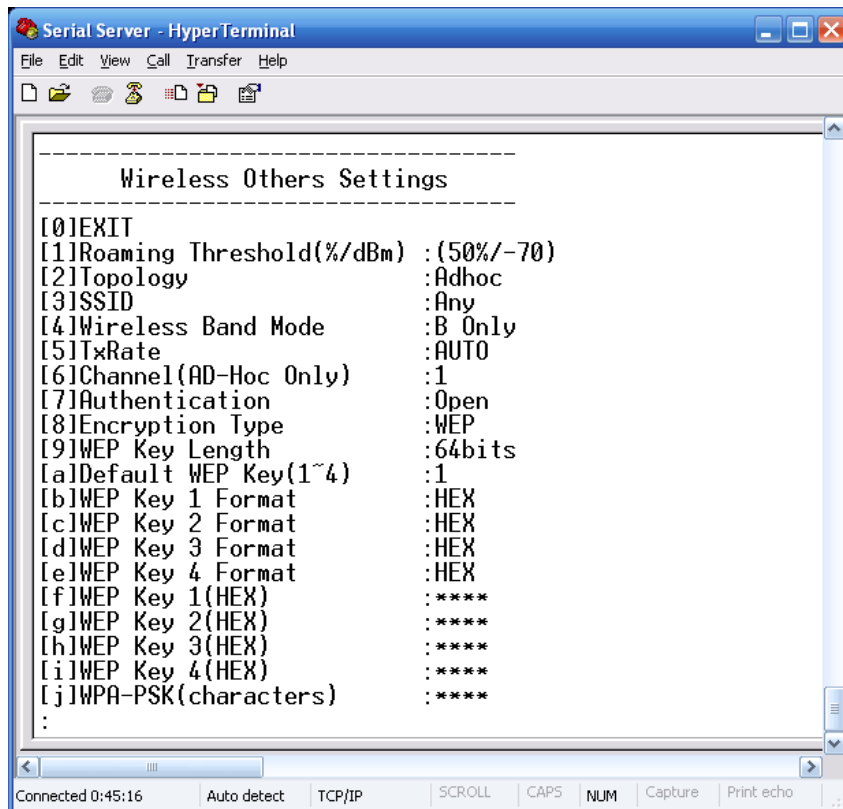

**Fig 53. Configure WEP 64 bits Settings in Ad-Hoc mode with open key**

- \* **Note1:** Enter 5 ASCII value or 10 Hexadecimal digit if select WEP64 encryption.
- \* **Note2:** Enter 13 ASCII value or 26 Hexadecimal digit if select WEP128 encryption

### 5.3.6. Configure Infrastructure Mode

**Operation:** [Main] → [3 Wireless Setting] → [7 Manually Settings] → [2 Topology]

The 802.11 infrastructure networking framework is the framework which devices communicated with each other have to connect to an Access Point (AP) first before connect to the other devices.

Wireless STW-602C supports different type of authorizations in infrastructure modes; include Open system, shared encryption with WEP64/128, WPA-PSK, from wireless encryption features.

The Figures below are some screen shot schemes for different authorized modes.

#### Settings with open authorization and none encryption

- **Topology:** Infrastructure
- **Channel:** Auto-assignment from Access point
- **Authentication:** open
- **Encryption:** None

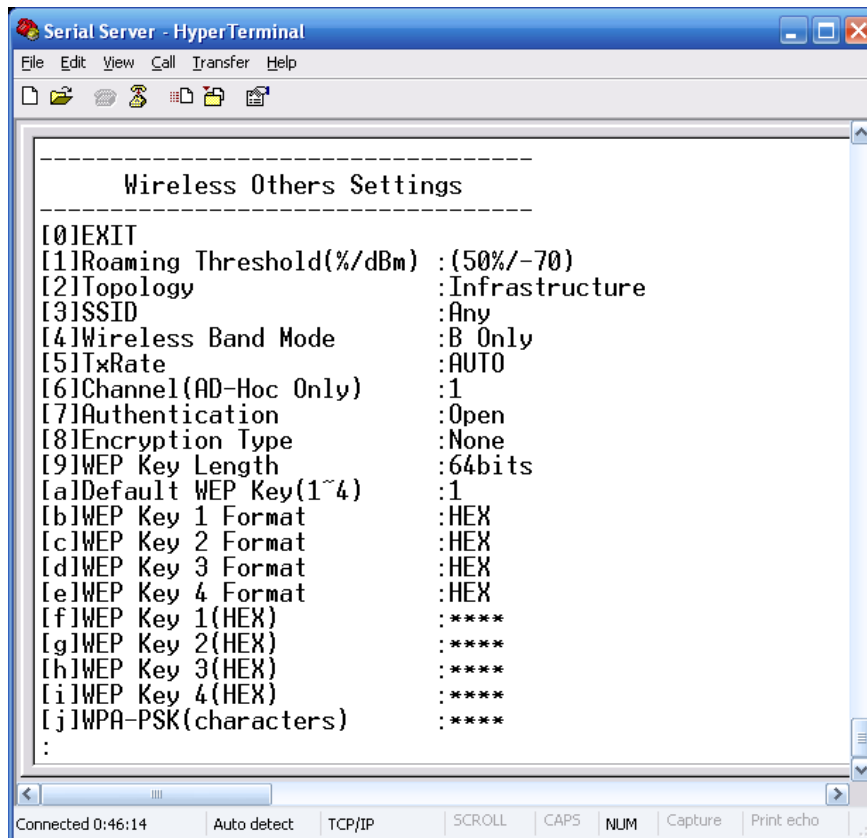
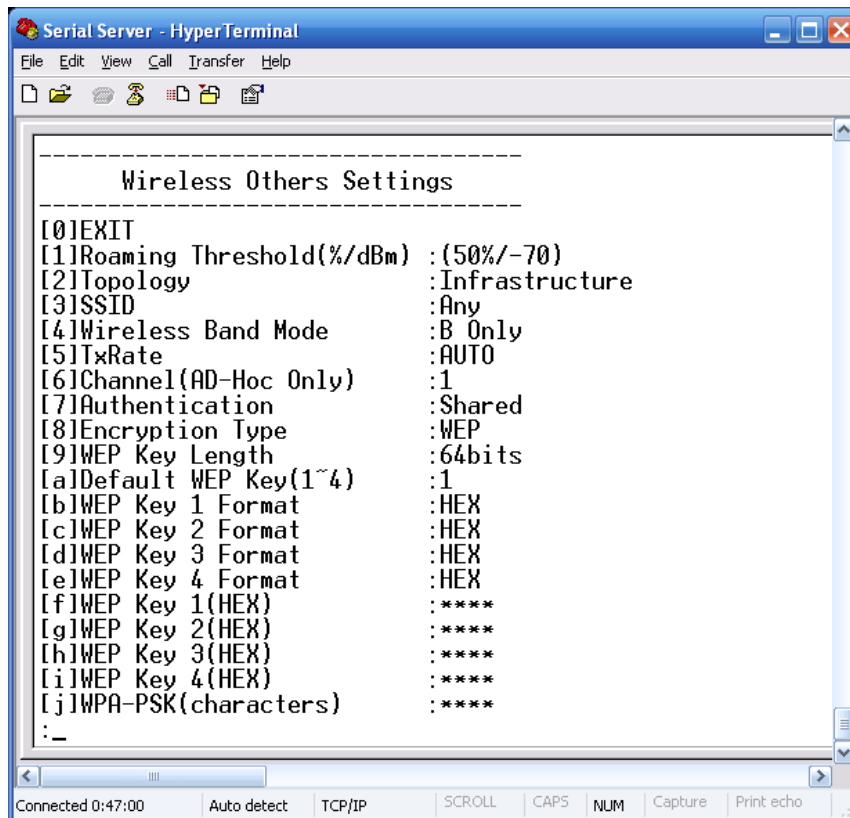

Fig 54. Wireless: Open authorization and none encryption

#### Configure share authorization with WEP encryption

- **Topology:** Infrastructure
- **Channel:** Auto-assignment from Access point
- **Authentication:** shared
- **Encryption:** WEP





**Fig 55. Wireless: Share authorization and WEP encryption**

**Configure wireless network via access point with WPA-PSK**

- **Topology:** Infrastructure
- **Channel:** Auto-assignment from Access point
- **Authentication:** WPA-PSK
- **Encryption:** TKIP or AES
- **WPA-PSK:** 8~ 63 Characters

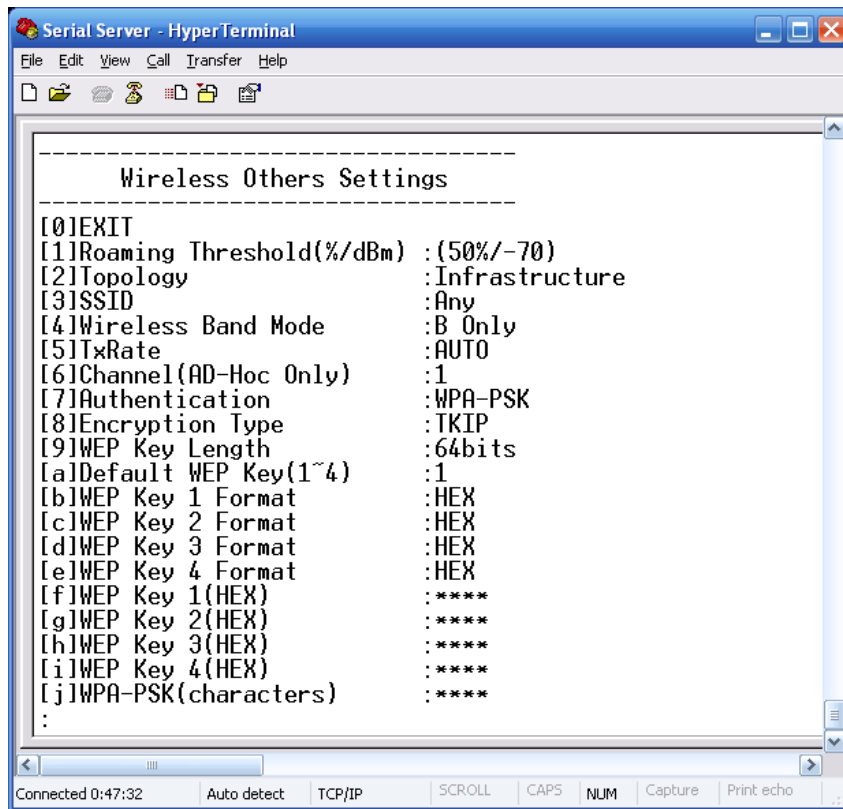

Fig 56. Wireless: WPA-PSK authorization and TKIP encryption

#### 5.4. COM Port Configuration

User can configure serial parameters, include COM1(COM2) operation mode, port parameters, enable or disable serial buffer's data and packet delimiter.

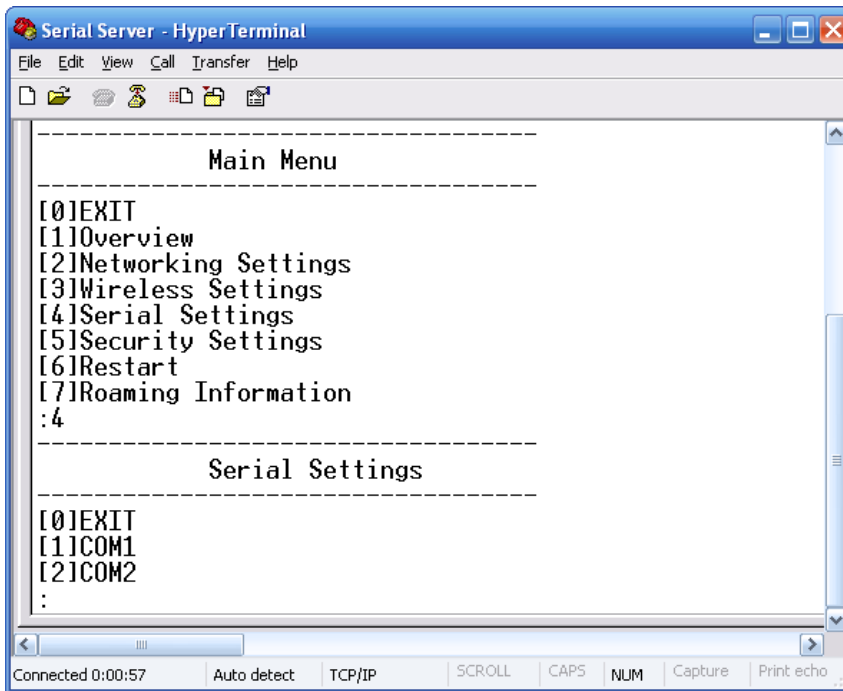

Fig 57. Select COM Port from Serial Settings by Telnet

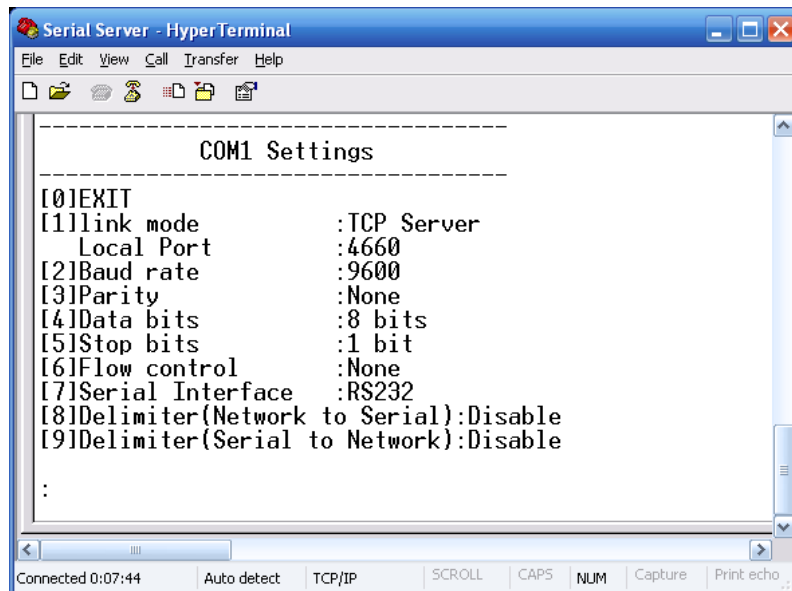

Fig 58. The COM1 Setting page

### 5.4.1. TCP Server Mode for Link Mode

**Operation:** [Main] → [4 Serial Settings] → [1 Link mode] → [1 TCP Server]

TCP Server mode is **default** setting for Link mode of serial settings of STW-602C, and it can be configured to wait for the host computers to establish a connection with the serial device through STW-602C. STW-602C needs to be configure the listening port to waiting for host connection, Default Port number of STW-602C is 4660 (4661) and it is associated with the serial port COM1 (COM2). After the connection is established, data can flow in both directions. STW-602C can wait for connection requested from remote PC which installed “**serial-to IP**” tool or counter-pair STW-602C in **tunneling mode**. After the application program being connected to the TCP port 4660 (4661) on the STW-602C, data of user application program are transmitted transparently to serial devices through STW-602C and vice versa.

User enters 1 at COM1 (COM2) Settings page and enters 1 for the TCP Server mode. To enable the remote client which install “**serial-to IP**” to connect to STW-602C, user has to **enable** the **Virtual COM** and Set up the designated **port** number.

**IP filtering** menu is a simple **ACL (Access Control List)**. It can be disabled by setting **FILTER\_IP** to “**0.0.0.0**”. User can configure one or group IPs for source IP in IP filtering. If **IP filtering** is **enabled**, only **source IP** assigned can connect to STW-602C.

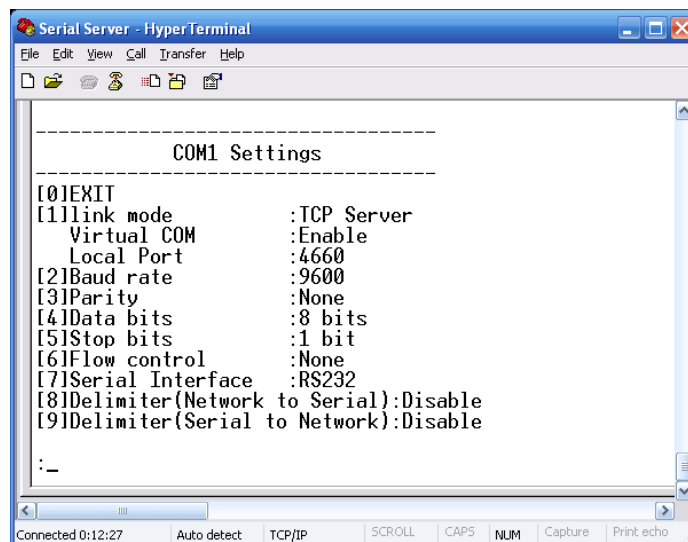

**Fig 59. TCP Server mode in link mode**

\* **Note:** Enable Virtual COM mode if the remote site PC's "Serial to IP" tool is installed.

### 5.4.2. TCP Client for Link Mode

**Operation:** [Main] → [4 Serial Settings] → [1 Link mode] → [2 TCP Client]

User can configure STW-602C to work in TCP Client mode. On destination IP & port (default: COM1:4660/COM2:4661), Enter the desired destination IP and port (Server IP and port) that STW-602C want to connect to (For example, another STW-602C, or PC for data-collection). The STW-602C can support two destination host computers simultaneously. **Fig. 60** is the **TCP Client** page.

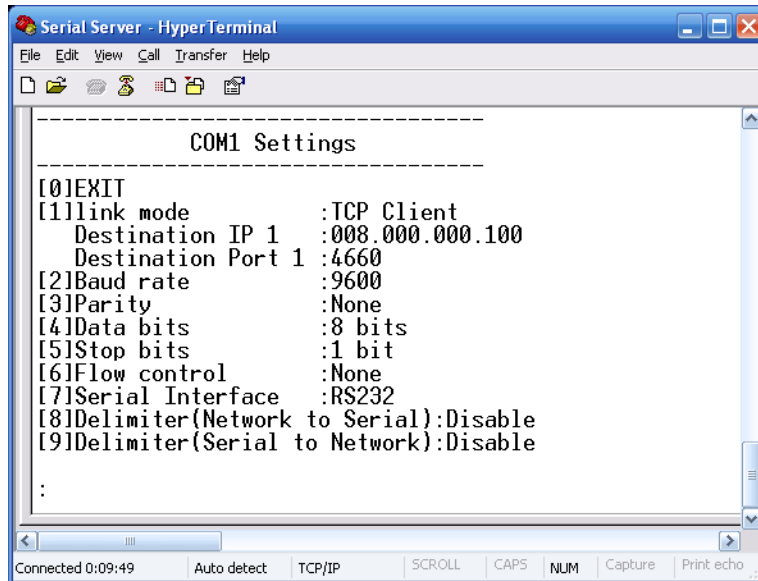

**Fig 60. TCP Client mode in link mode**

### 5.4.3. UDP for Link Mode

**Operation:** [Main] → [4 Serial Settings] → [1 Link mode] → [3 UDP]

STW-602C can be configured to work in UDP mode to establish connection using **Unicast** or **Multicast** protocol. Data can be transmitted from one or multiple serial devices to/from one or multiple host PCs and vice versa. For example, the original RS-422/ RS485 bus data is transferred over the extended connected distance by STW-602Cs, The destination IP is assigned by single IP or group IPs, The configuration is limited by the Local Listening Port, default 4660 and 4661 on the COM1 and COM2 of STW-602C.

STW-602C can support up to 4-group IPs for UDP connection, if users needed.

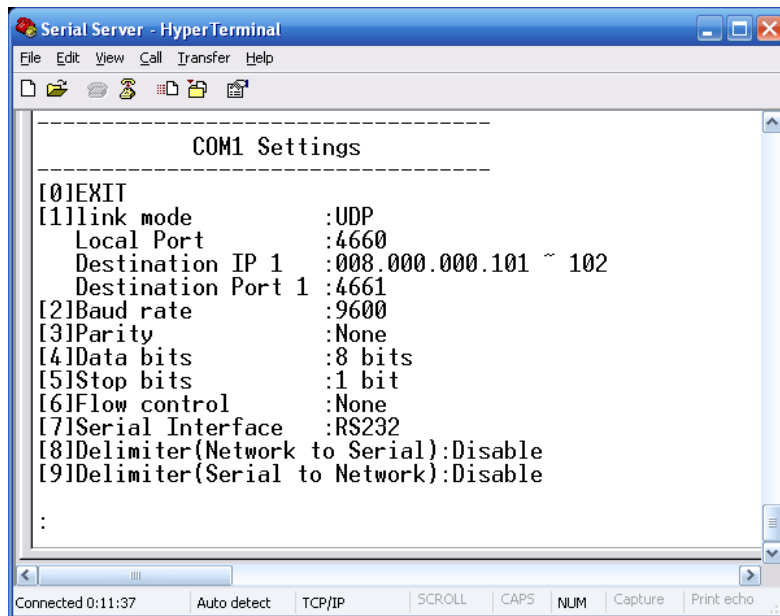

Fig 61. UDP mode in link mode

\* Note: In this phase, UDP mode does not support Virtual COM mode.

#### 5.4.4. Serial Settings

Operation:

[Main] → [4 Serial Settings] → [2 Baud rate]/ [3 Parity]/[4 Data bits]/ [5 Stop bits]/ [6 Flow control]

User can configure **baud rate**, **data bits**, **parity**, **stop bit** and type of **flow control**.

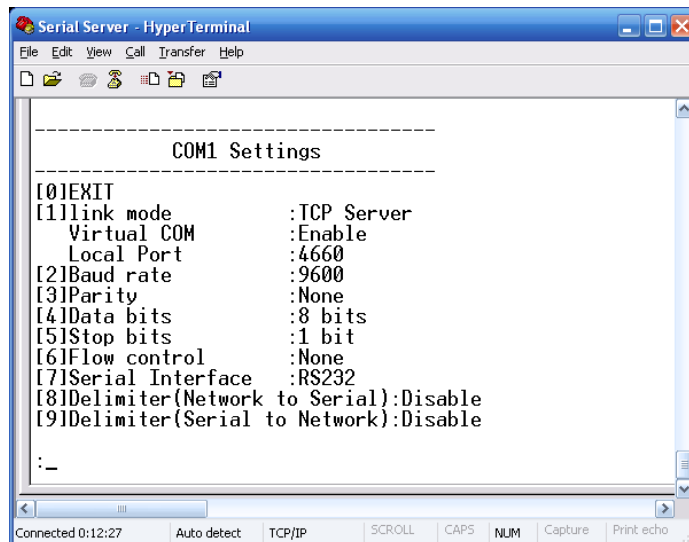

Fig 62. Serial Settings by Telnet

#### 5.4.5. Packet Delimiter

[Main] → [4 Serial Settings] → [8 Delimiter (Network to Serial)]/ [9 Delimiter (Serial to Network)]

Packet delimiter is a way of controlling the number of packets in a serial communication. It is designed to keep packets in track. STW-602C provides two ways in packet delimiter parameter setting: (1) Packet delimiter **by timer** and (2) Packet delimiter **by character**. By **default**, **packet delimiter timer is 10 ms**. The ranges of packet delimiter timer is 10 to 30,000 ms, If "character pattern" is selected, for a data stream ended with "0x0d0a", then the entire data buffer of the serial device is transmitted.

User can change packet delimiter timer by following the steps below.

## Configure Network Delimiter using Timer

[Main]→[4 Serial Settings]→ [8 Delimiter (Network to Serial)]/ [9 Delimiter (Serial to Network)]  
→[1 Timer]

User can choose **packet delimiter timer**'s value as the packet delimiter indicated in **Fig. 63** below

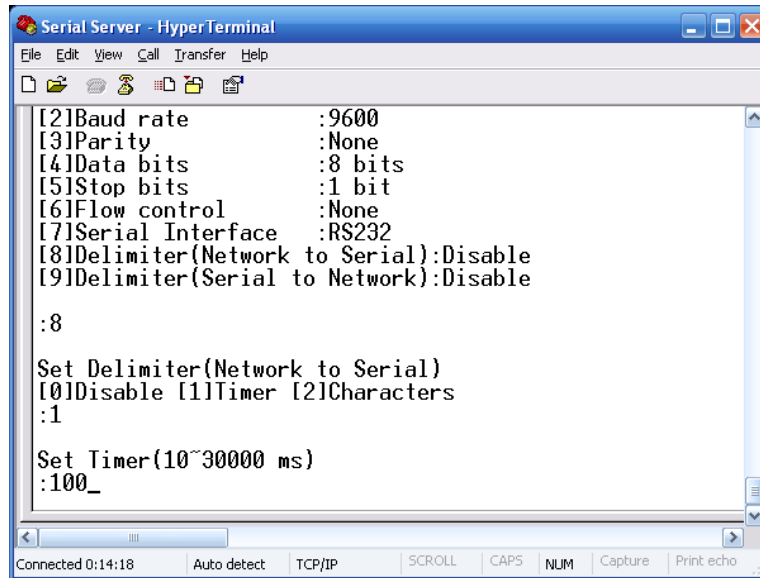

Fig 63. Configure Network Delimiter using Timer

## Configure Network Delimiter using Characters

[Main]→[4 Serial Settings]→ [8 Delimiter (Network to Serial)]/ [9 Delimiter(Serial to Network)]  
→[2 Characters]

User can choose **packet delimiter character** pattern as the packet delimiter indicated in the **Fig. 64** below:

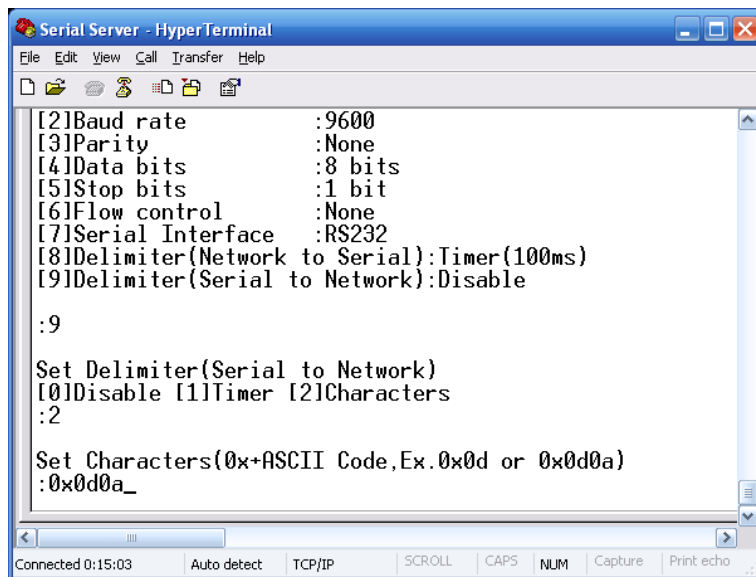

Fig 64. Configure Network Delimiter using Characters

## 5.5. Security Configuration

Operation: [Main] → [5 Security]

User can change password of STW-602C with this menu.

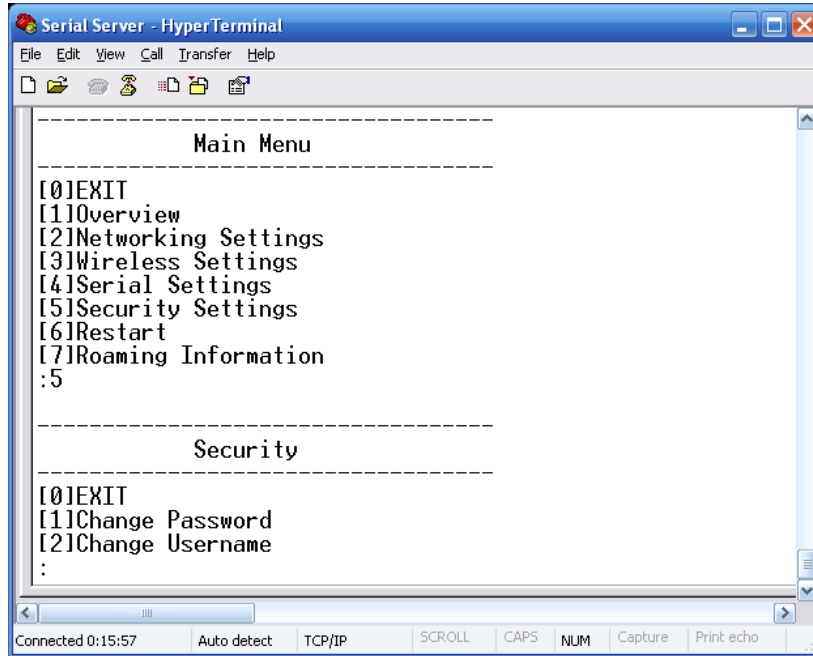

Fig 65. Security settings by Telnet

### 5.5.1. Change the Password

Operation: [Main] → [5 Security]→ [1 Change Password]

Enter desired password on “New password” fields.

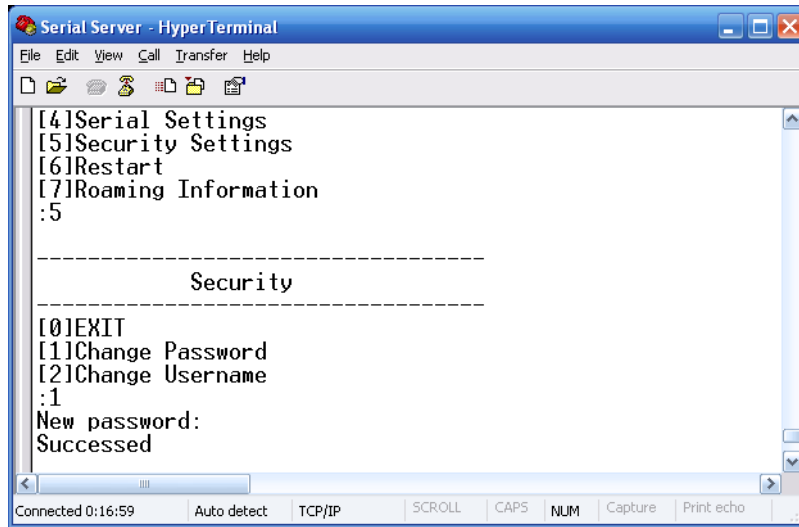

Fig 66. Changing the Password by Telnet

\* Note: User may press the reset key on the product to reset to default password (blank).

\*

\*

\*



## Appendix A. Using Virtual COM

**Virtual COM** driver mode for windows converts COM port data (RS232) to IP data to control the RS-232C port on a STW-602C over the IP network. By creating Virtual COM ports on the PC, Virtual COM redirects the communications from the Virtual COM ports to an IP address and port number on a STW-602C which connected to the serial devices. The following figure is Virtual COM connection diagram.

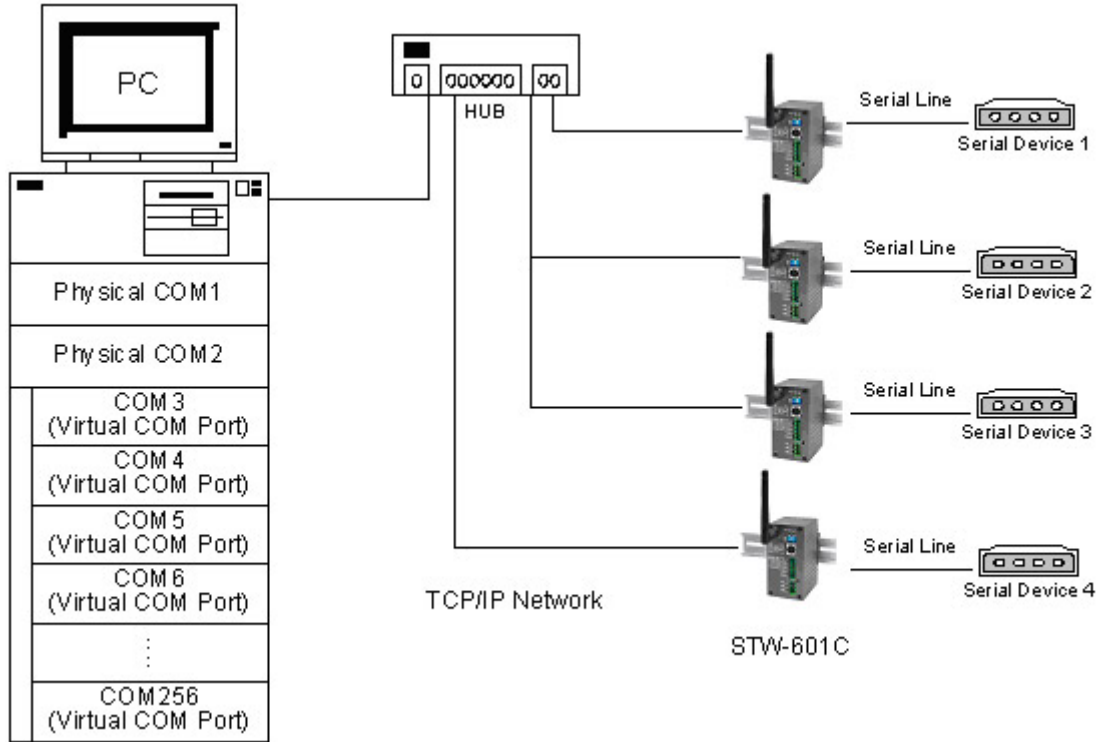

Fig 67. Setup of a Virtual COM driver

### A.1. Pre-installation Requirements

Please check the operating system on your PC complied with the following requirements:

- Processor: Intel-compatible, Pentium class
- Operation system: Windows Server 2003, Windows XP, Windows 2000, Windows NT 4.0 SP5 or later, Windows Me, Windows 98, Windows 95, Microsoft NT/2000 Terminal Server, Citrix Meta Frame
- Windows Installer 2.0
- Network: Microsoft TCP/IP networking software

### A.2. Applying to the STW-602C

#### Limitation

Virtual COM driver provides user to select up to **256 COM ports** as Virtual COM ports in a SerialManager Utility PC. User can select them from a list of COM ports, which is from COM1 up to COM256.

#### Installation

Make sure you have turned off all anti-virus software before beginning the installation. Run Vcom.exe program included in the CD to install Virtual COM for your operating system.

In the end of the installation, please select one or two COM ports to become the Virtual COM ports.

## Uninstalling

- From Windows Start menu, select Setting\ Control Panel\ Add/Remove Programs.
- Select Serial IP for in the list of installed software.
- Click the Add/Remove button to remove the program, or From Windows Start menu select Programs, Serial IP click Uninstall Serial IP to remove the program.

## A.3. Virtual COM Communication

### Enable Virtual COM on STW-602C by web interface

From web browser access to STW-602C by typing its IP address, click on “**Serial**” link to access Serial page, on the top half of the page click on “**TCP Server**” and enable Virtual COM by putting a check in front of the “**Enable**” checkbox, then type in the local port number in the “**Local Port**” field as indicated in the following screen.

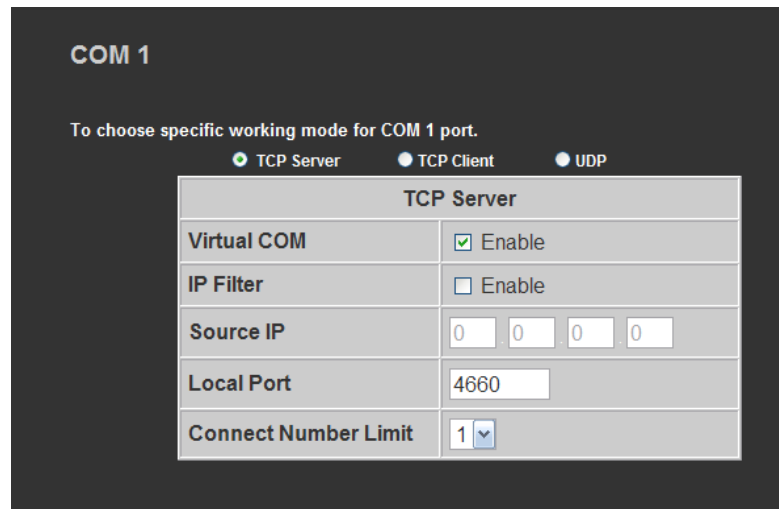

The screenshot shows a web interface for configuring COM 1. At the top, it says "COM 1" and "To choose specific working mode for COM 1 port." Below this are three radio buttons: "TCP Server" (selected), "TCP Client", and "UDP". A table titled "TCP Server" contains the following settings:

TCP Server	
Virtual COM	<input checked="" type="checkbox"/> Enable
IP Filter	<input type="checkbox"/> Enable
Source IP	0 0 0 0
Local Port	4660
Connect Number Limit	1

Fig 68. Enable Virtual COM Mode by Web page

### Enable Virtual COM on STW-602C by Telnet

User may also enable Virtual COM through telnet by setting Serial as a TCP server, and enter the local port number for Serial, then enable virtual COM as shown in the following procedure:

## Login STW-602C via Telnet

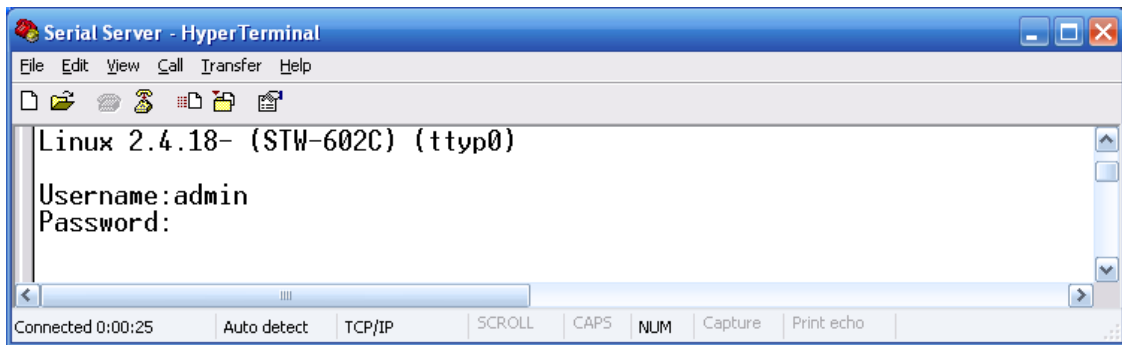

Fig 69. Login into STW-602C by Telnet or Console

Select **serial setting** for TCP server/Client, and enabling Virtual COM mode

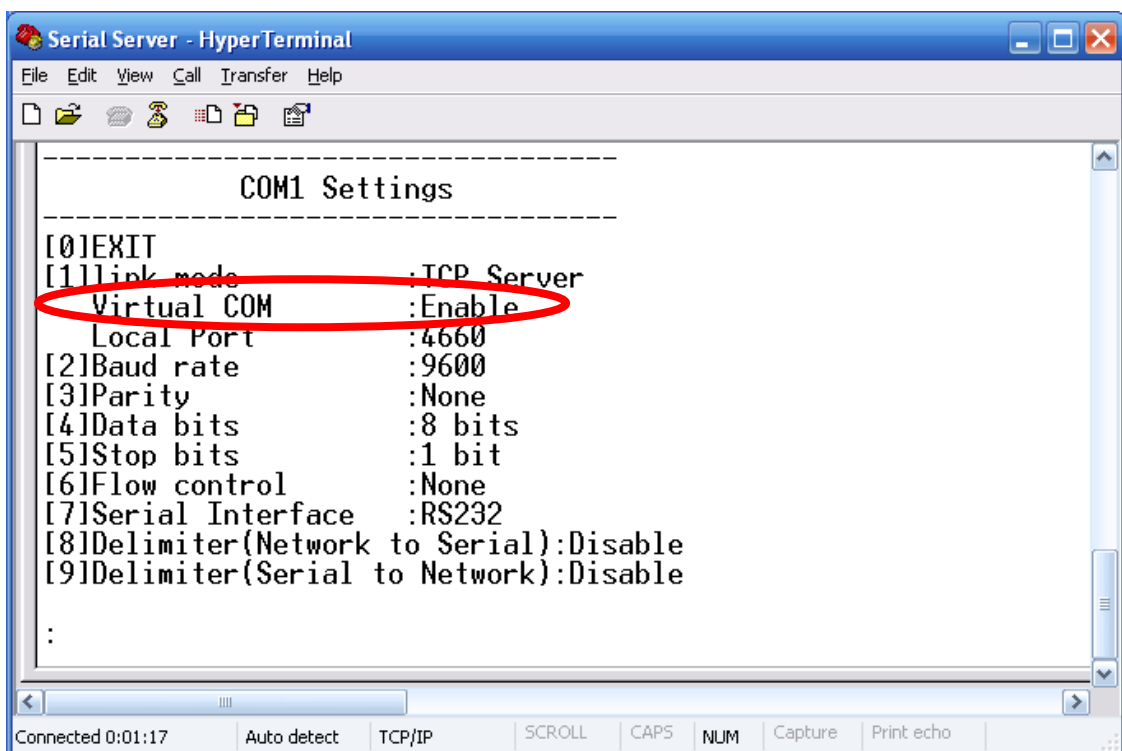

Fig 70. Enable Virtual COM mode by Telnet

## Running Serial to IP for program on PC

On Window Start Menu, go to `program\Serial/IP\Control panel\`, The “Serial to IP for Control Panel” window shall appear. Then select the serial port.

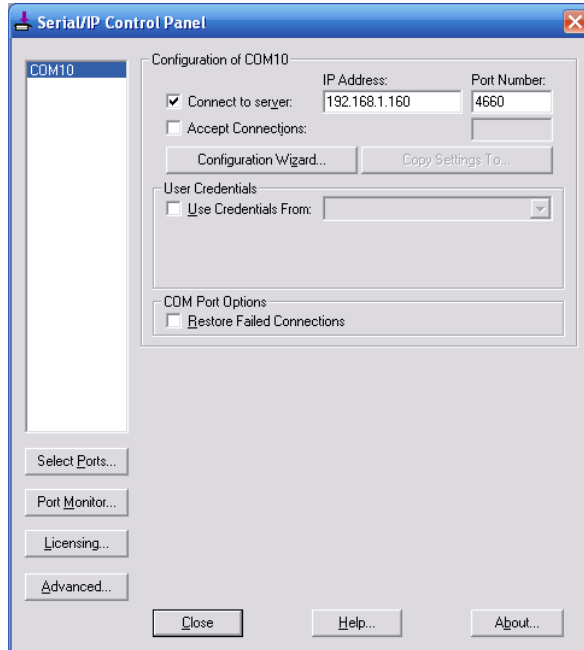

Fig 71. Detail setting from Serial/IP

On the right of the panel is a sample for COM 4 settings. On the left is the list of the COM ports that have been selected (on **Select Ports** window) for use by the Virtual COM Redirector. Change the list by clicking the **Select Ports** button.

Each COM port has its own settings. When click on a COM port, the Control Panel changes to reflect that the selected port.

\* **Note: COM port changes become effective immediately.**

## Configure Virtual COM Ports

Serial/IP COM port can be changed as follows:

- Select a COM port on the list.
- On **IP Address of Server**, enter STW-602C IP address.
- On **Port Number**, enter the TCP port number of the STW-602C.
- On **Server Credentials**, the default is **No Login Required**. If the STW-602C does require login by the Virtual COM Redirector, the Virtual COM Redirector must provide a username and/or password every time an application tries to access the STW-602C.
- Click the **Configuration Wizard** button and then click the **Start** button that shall appear on the wizard window. This step verifies that the Virtual COM Redirector communicates with the STW-602C. If **Log** display does not show errors, click **Use Settings**, return to the Control Panel
- Settings on the **Connection Protocol** must match the TCP/IP protocol supported by the STW-602C. The Configuration Wizard is capable of determining the correct settings.
- On **COM Port Options**, the settings must match the COM port behavior expected by the PC application. The Configuration Wizard will recommend such settings.

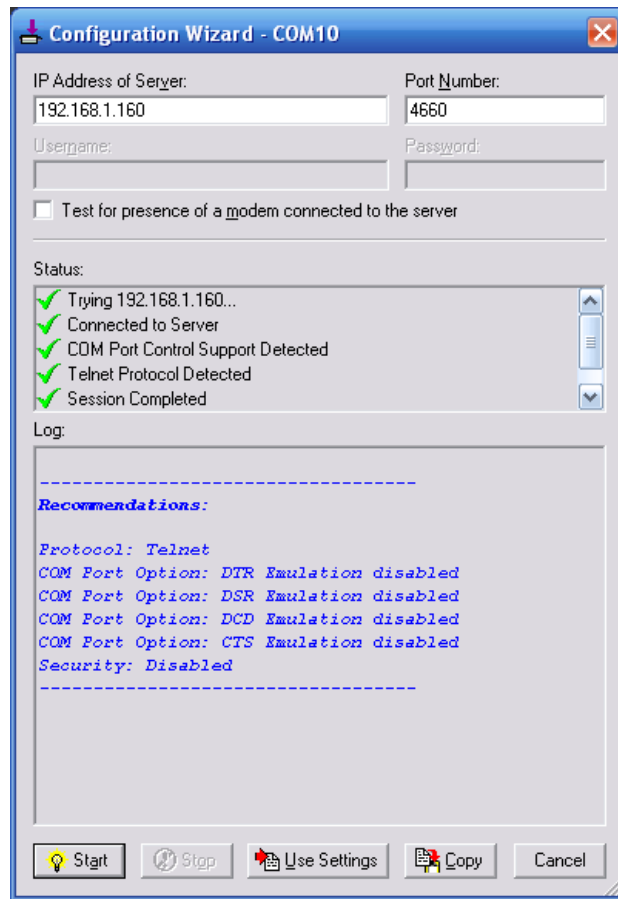

Fig 72. Configuration Wizard from Serial to IP tool

## Appendix B. Configuration Utility

### B.1. SerialManager utility Introduction

**SerialManager utility**, is a special tool for device management and configuration, and can realize the daily management on various network devices for address search, device positioning, parameter configuring, firmware downloading and so on.

### B.2. Interface

The operating interface of the **SerialManager utility** shown as below:

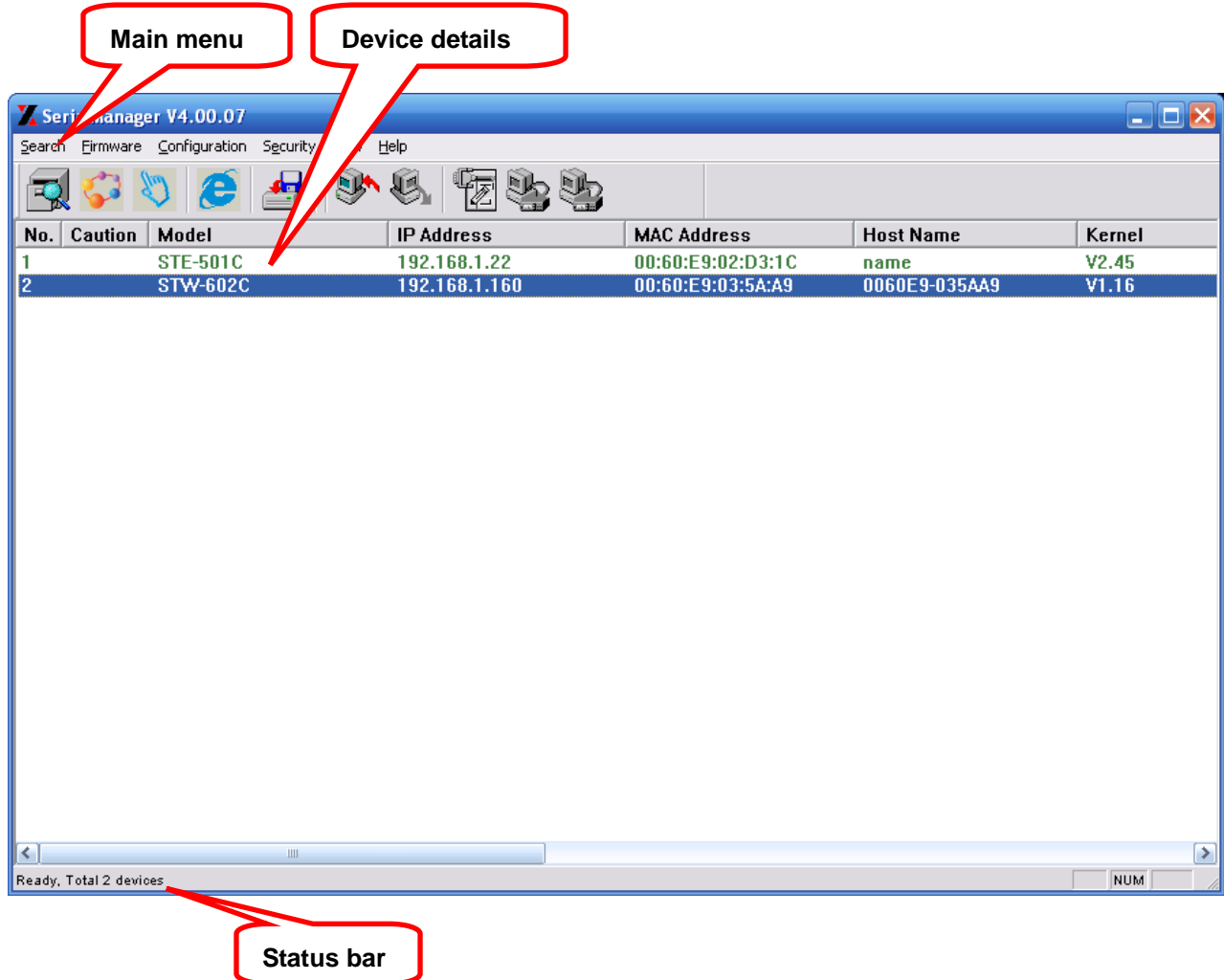

### B.3. Functions

#### B3.1 Device Search

This function is applied to search devices in the network. The user can use four ways to search devices. They are search by broadcast, search by special IP addresses, search by special MAC addresses and rescanning devices by using the current search way. The user can select his required search way by clicking the **Search** option on the main menu, shown as below:

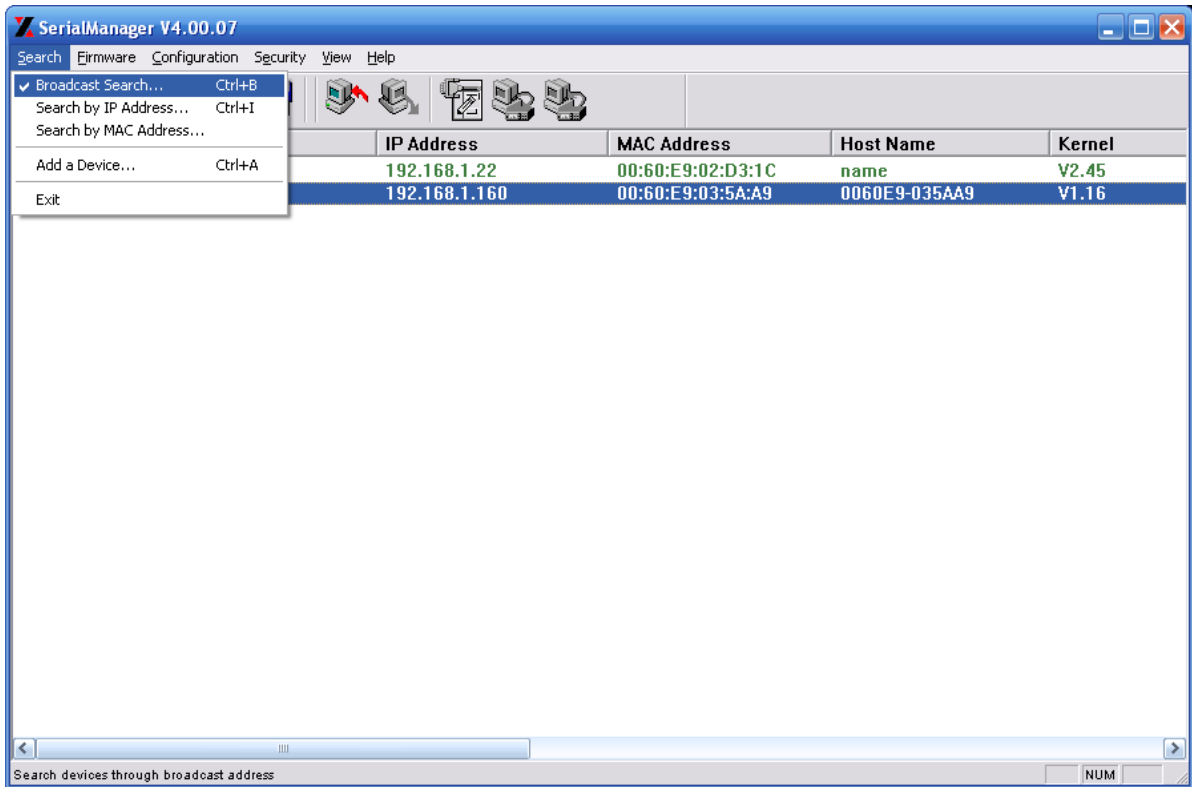

Or, select by clicking a button on the toolbar, as below:

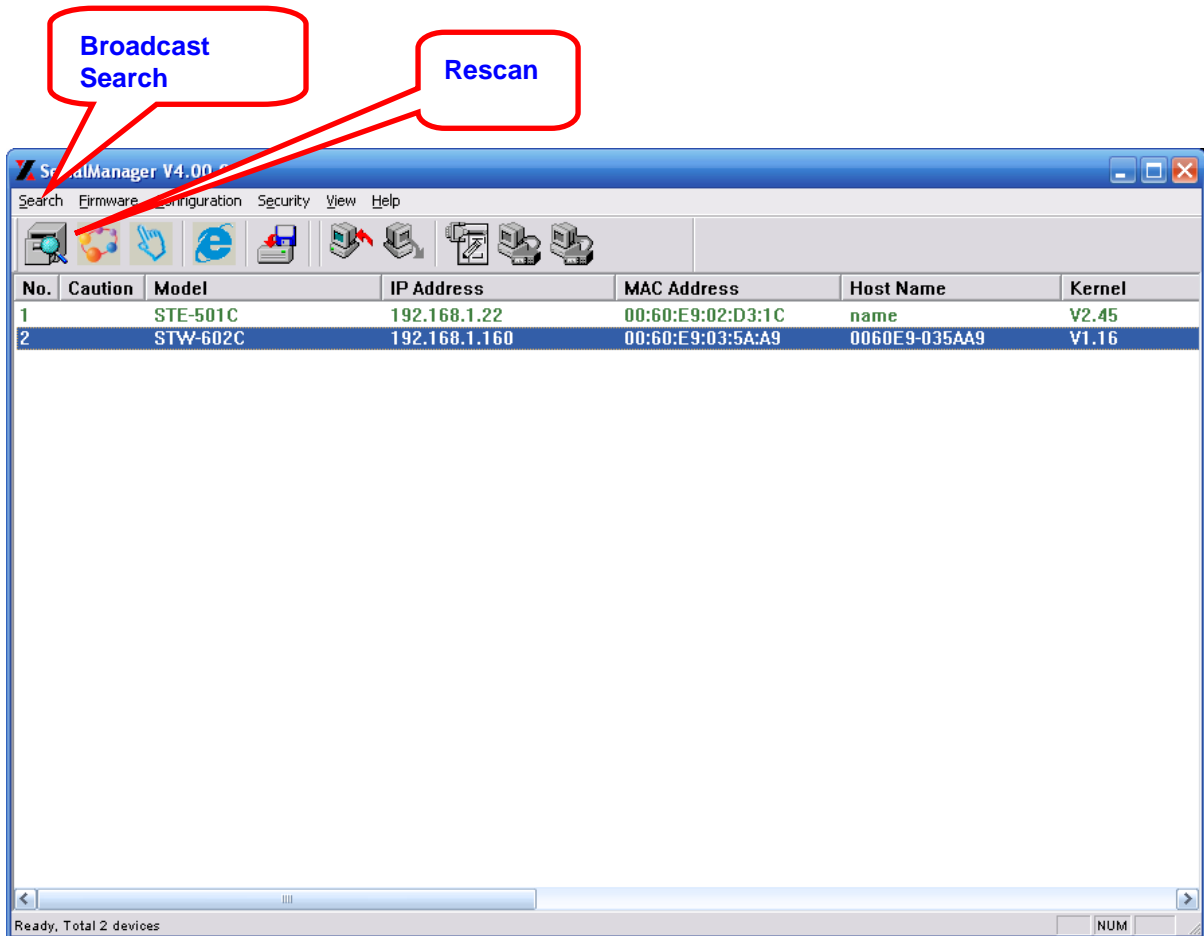

### B3.1.1 Broadcast Search

Once **Broadcast Search** is selected, a box will pop up as below:



The user may type in or select different broadcast address based on his/her own requirement.

### B3.1.2 Search by IP address

Once **Search by IP Address** is selected, an interface will pop up as below:

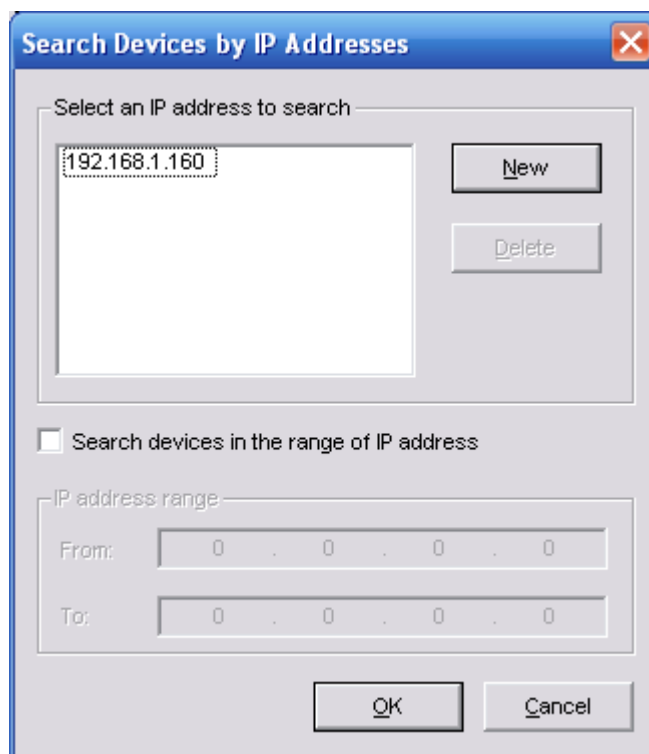

Here user may have two options: **Select an IP address to search** or **Search device in the range of IP address**.



### B3.1.3 Search by MAC Address

If **Search by MAC Address** is selected, another box will pop up as below:



Here the user may search in two ways: **Search a MAC address to search** or **Search devices in the range of MAC address**

### B3.1.4 Rescan

Once the user click the **Rescan** button on the toolbar, the SerialManager utility shall re-search devices by using the current search way.

### B3.2 Firmware

This function is applied to downloading a firmware into a selected device.

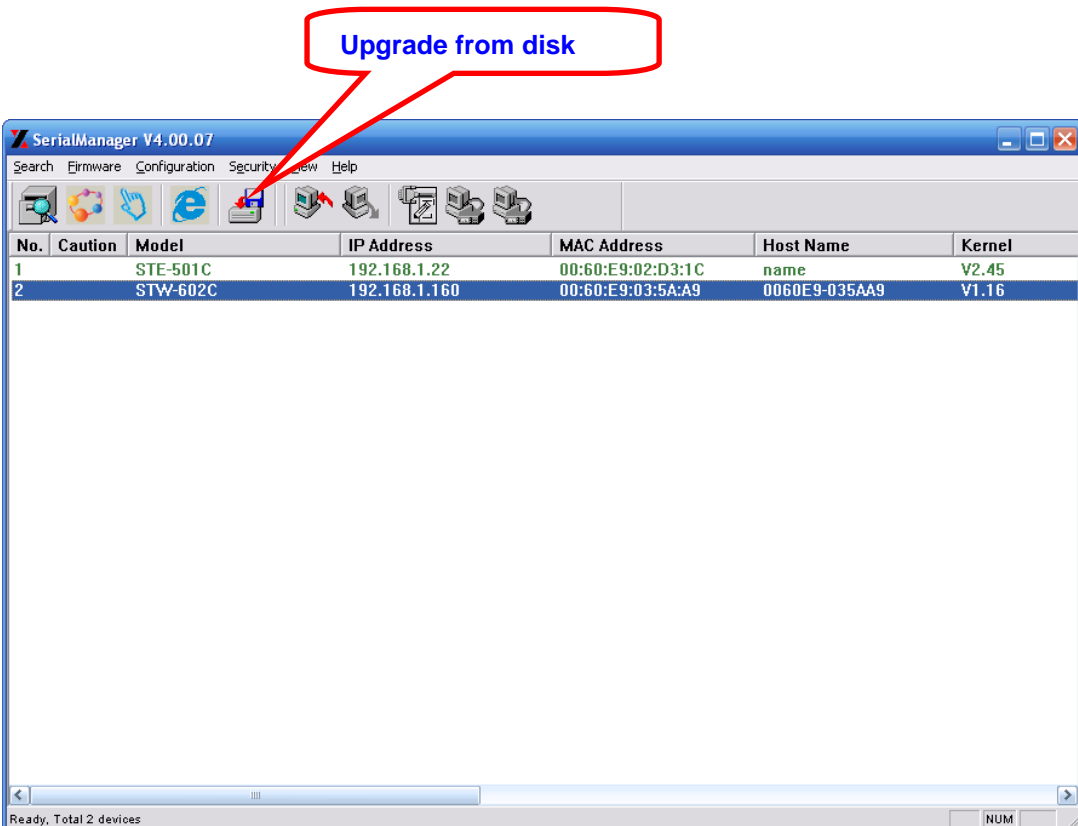
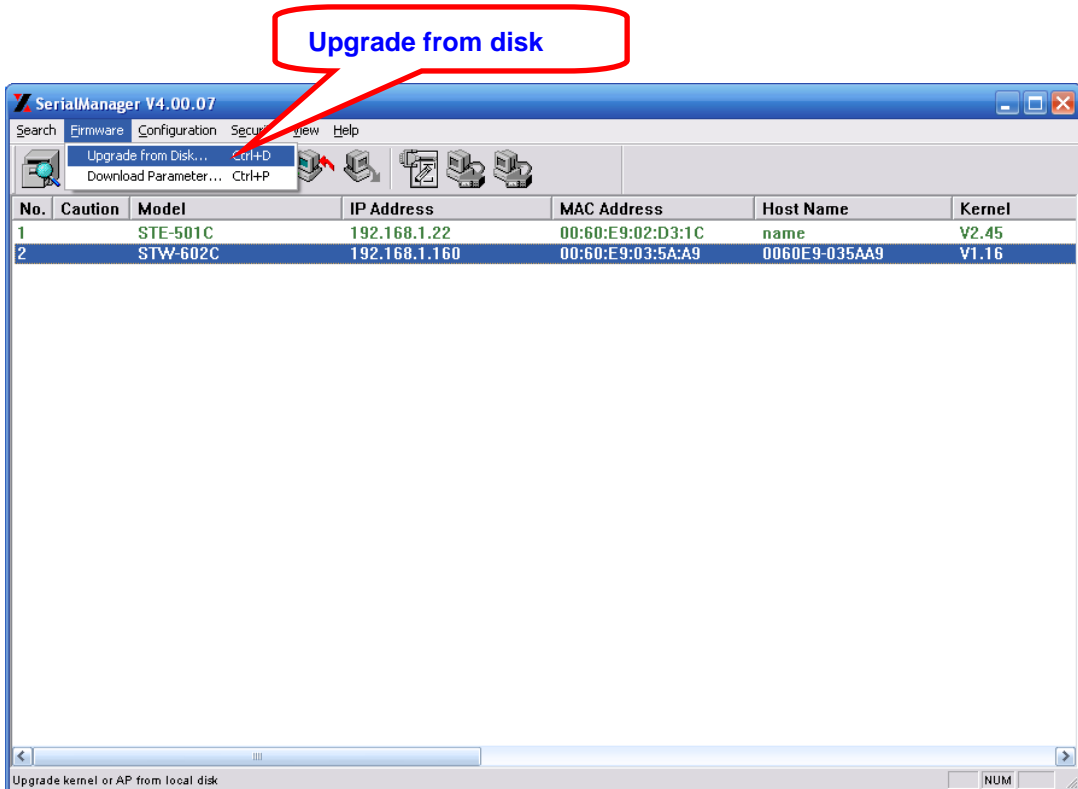

The user can enter the window for downloading by firstly clicking a designated network device, and then selecting the submenu option **Upgrade from disk** in the main menu option **Firmware**, or directly clicking the button **Upgrade from disk**. And then the user can select and download the required firmware from the disk, as shown in the figure below:

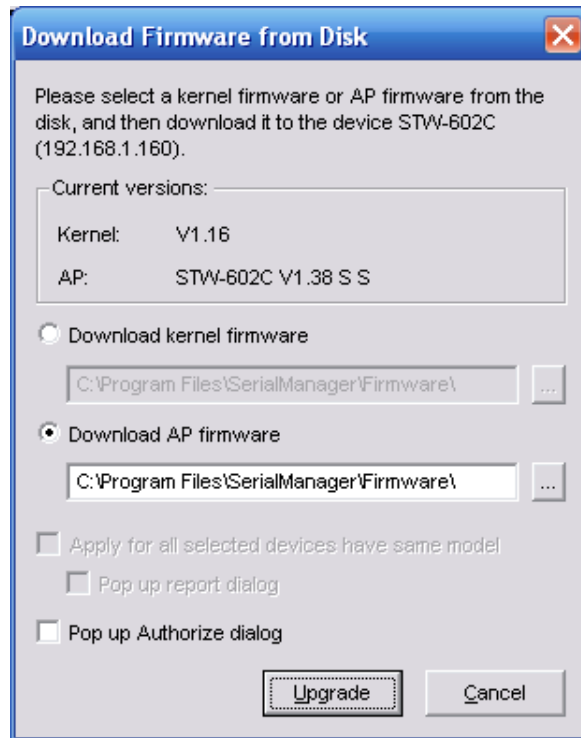

The user can also select several same devices at one time, and realize the firmware updating for them by selecting **Apply for all selected devices have same model**.

Download Parameter

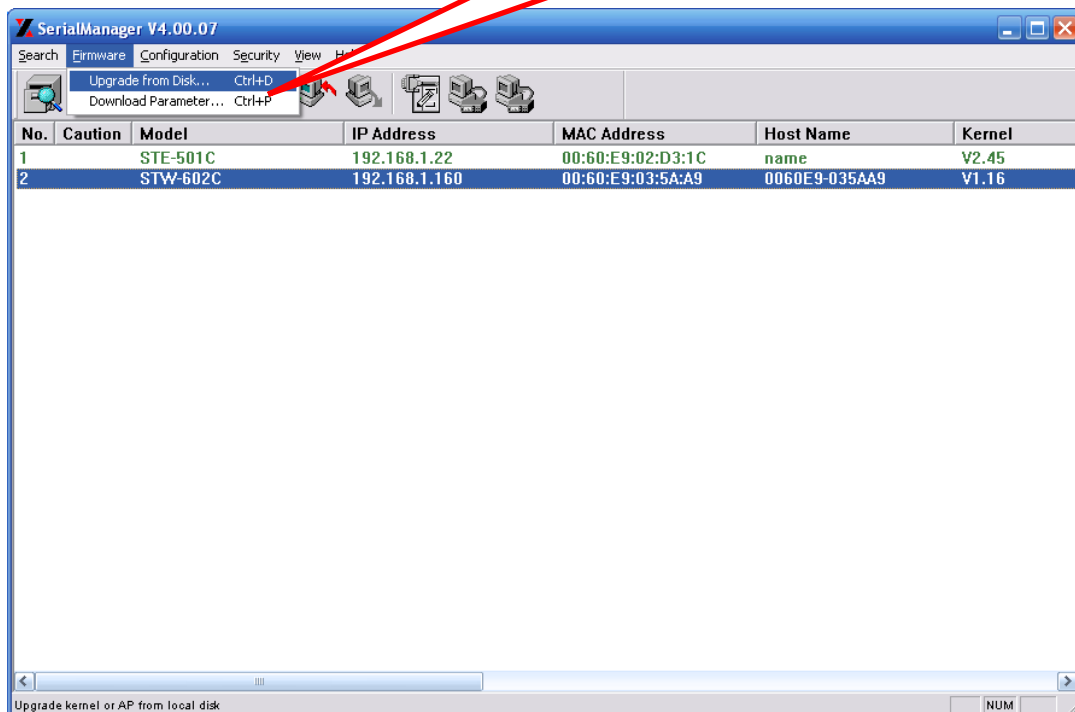

In addition for some devices with JFFS2 file system supported, the user can download the related parameter data into the device that supports the JFFS2 file system through a submenu **Download Parameter**. See details as the figure below:

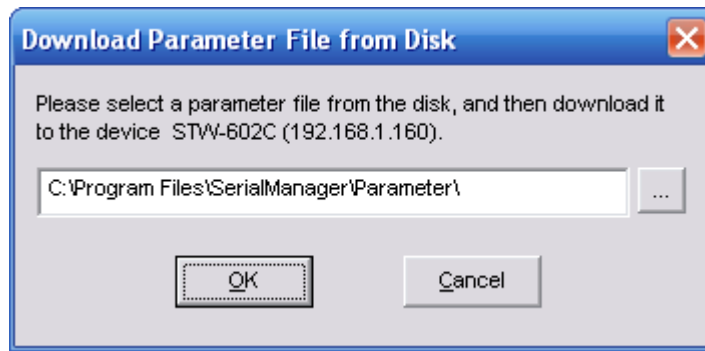

**Note:** Some of old firmware version did not support SerialManual firmware upgrade function. Please refer to appendix "Upgrading System Software "for detail.

### B3.3 Security

This function is applied to the security protection for the network devices, so as to supply some necessary protection to a device for configuration modifying, configuration leading-in and leading-out, and some other important functions. Here three functions are mainly supplied, including: **Login**, **Logout** and **Change Password**, shown as the figure below:

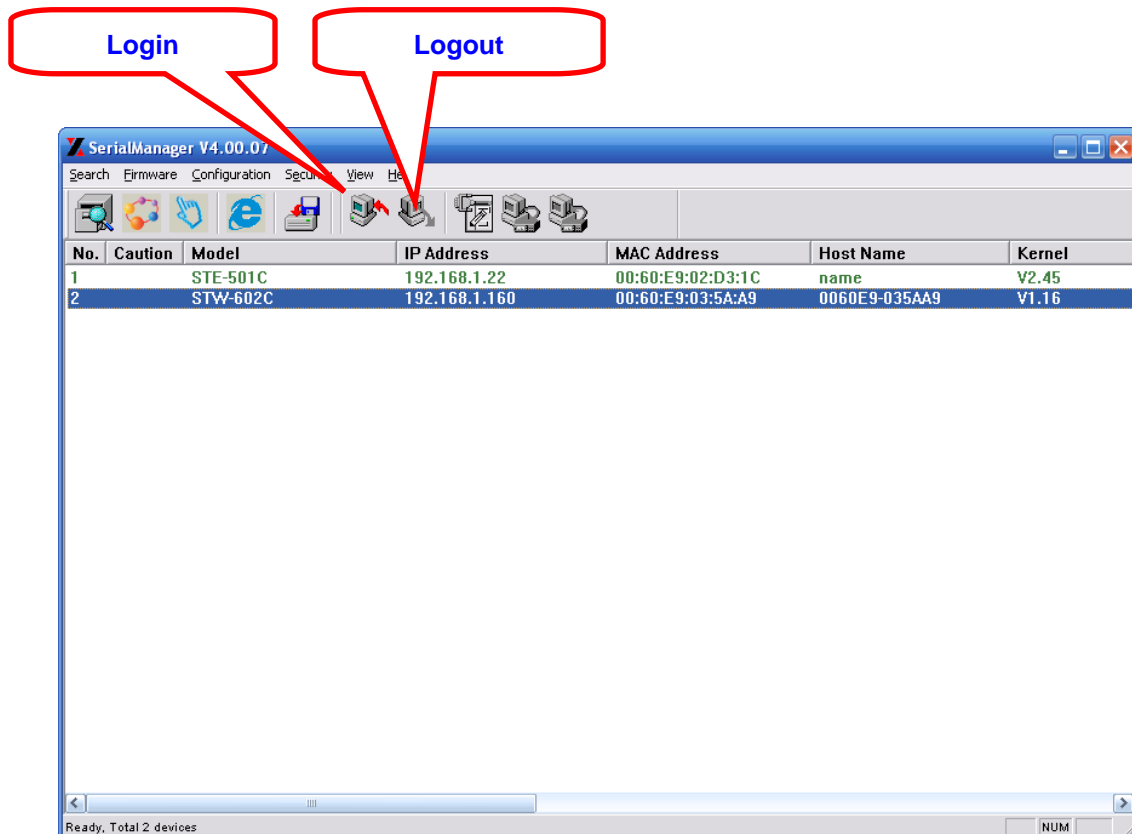

#### B3.3.1 Login

This function is applied to the login to any network device, as some important devices can only be operated after a successful login, shown as the figure below:



The user can also select several devices at one time, and log in them at the same time by selecting **Apply for all selected devices**.

### B3.3.2 Logout

This function is applied to the logout from any network device, as the user should always carry out a logout after he/she has finished the operating action to any important device, shown as the figure below:

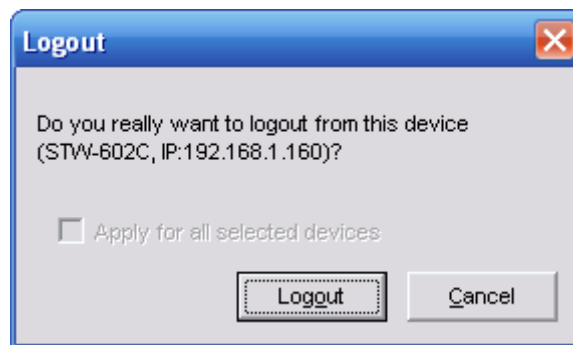

The user can also select several devices at one time, and log out them at the same time by selecting **Apply for all selected devices**.

### B3.3.3 Change Password

This function is applied to modifying the password for logging in any network device, but can only be realized after a successful log-in, shown as the figure below:



The user can also select several devices at one time, and modify their pins at the same time by selecting **Apply for all selected devices**.

### B3.4 Configuration

This function is applied to the configuring, import and export of work parameters for any network device, and here are mainly supplied with: 'Network ...', 'COM Port...', 'Locate', 'Reset', 'Erase Flash', 'Import Setting...', 'Export Setting...', 'Virtual COM...', 'Config by IE' and 'Options', and some other application functions. The user can carry out a configuration operating through menu or by clicking the corresponded button on the toolbar, shown as the figure below:

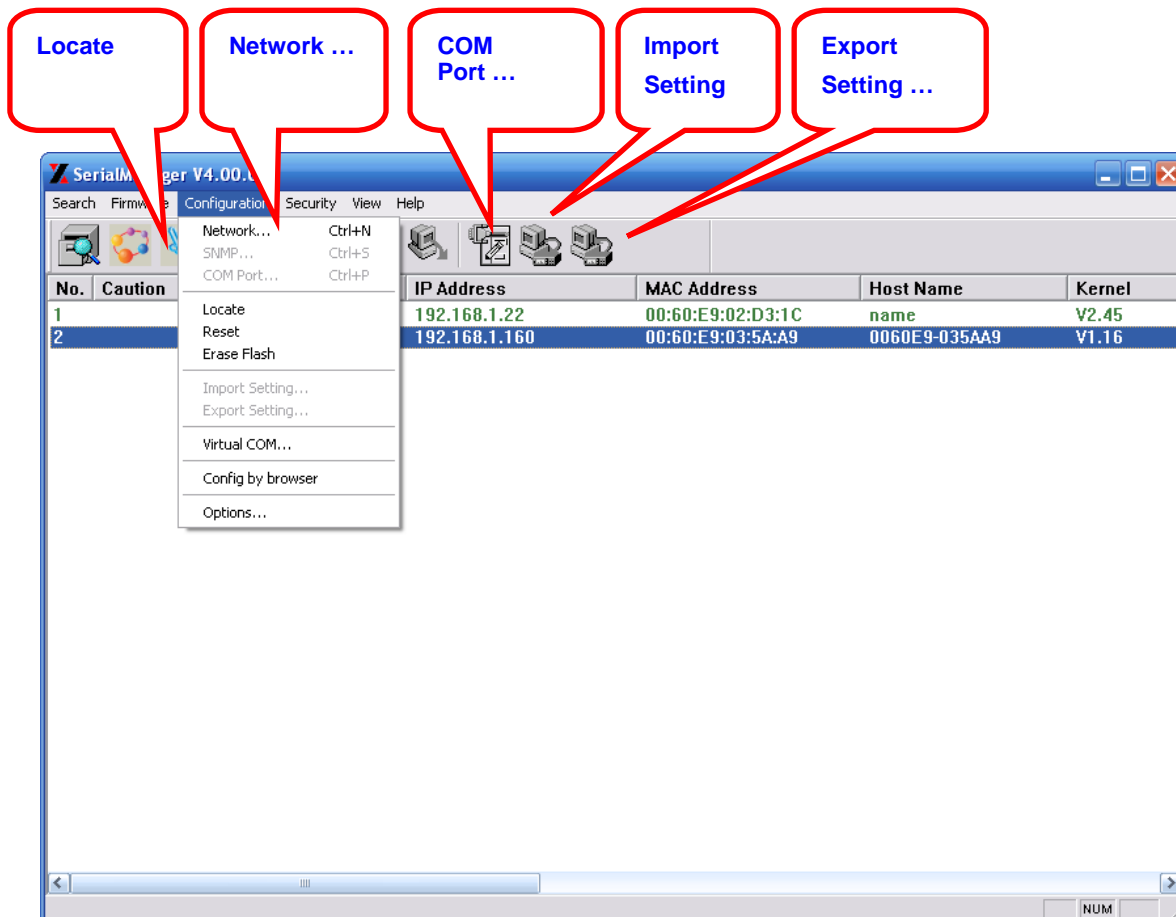

#### B3.4.1 Network ...

The user can modify the IP address of any selected device, shown as the figure below:

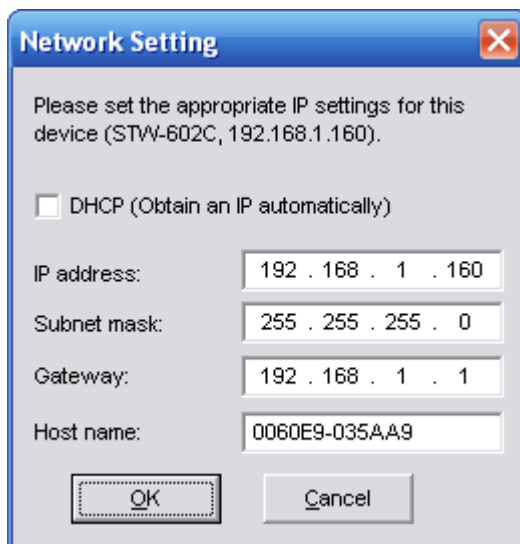

### B3.4.2 COM Port ...

Various network products and some of the devices are specially supplied to some serial-port servers, while this function is applied to the configuration of COM port parameters.

Note: This function can be realized only after a successful login, shown as the figure below:

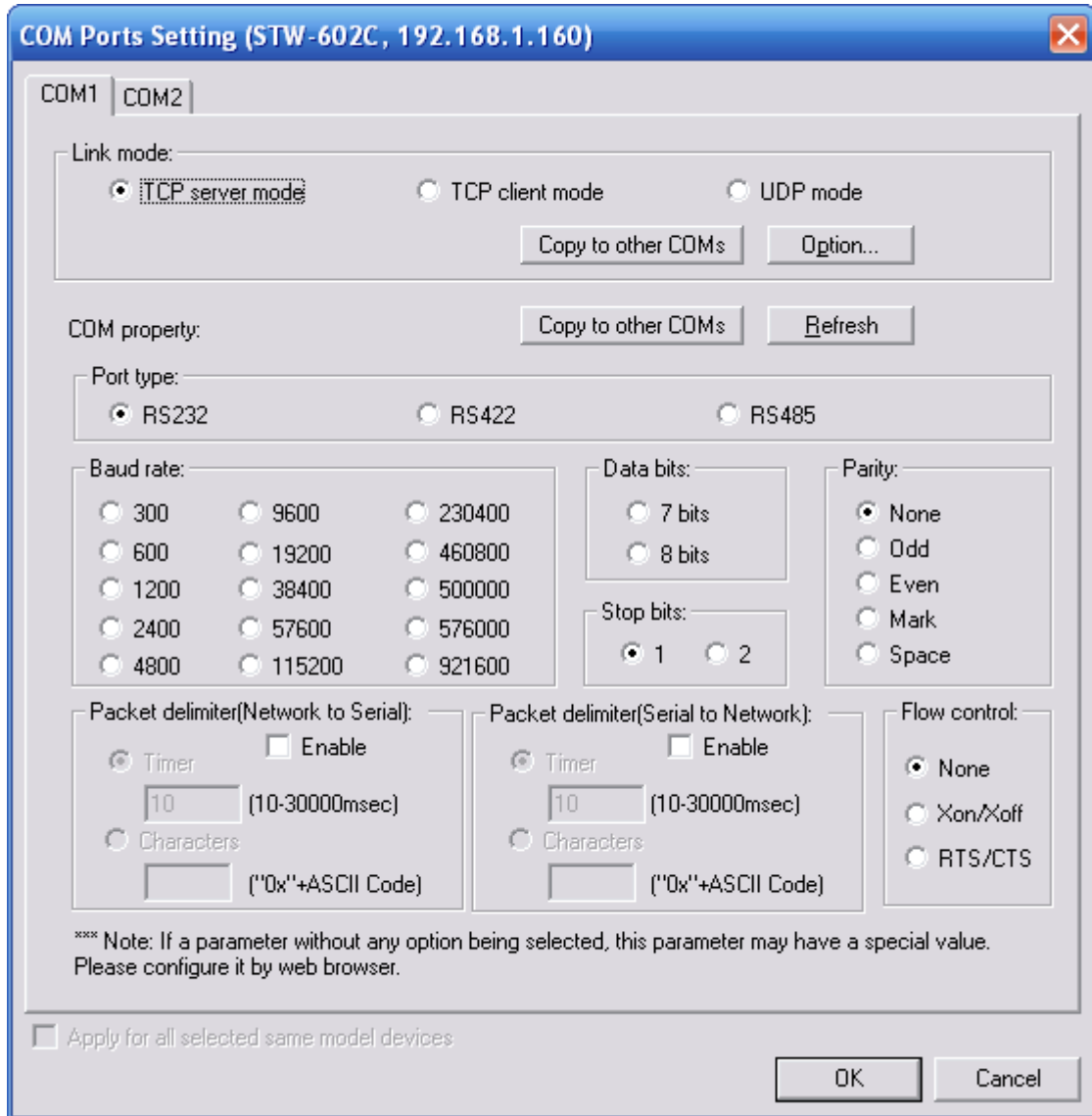

The user can also select several devices at one time, and carry out the configuration for them at the same time by selecting **Apply for all selected same model devices**

Note:

- 1 . COM tags: generated automatically according to the COM port number of the device. If a device has 4 COM port, there will be 4 tags: respectively COM1, COM2, COM3, COM4, and the like.
- 2 . Connecting mode: it means the connecting mode between the serial-port server and other network devices. Each COM corresponds to a connecting mode through which the transferring data will not be interfered by that in another connection. The user can set each corresponded connecting mode and the working parameter by clicking the button "Option", shown as the figure below:

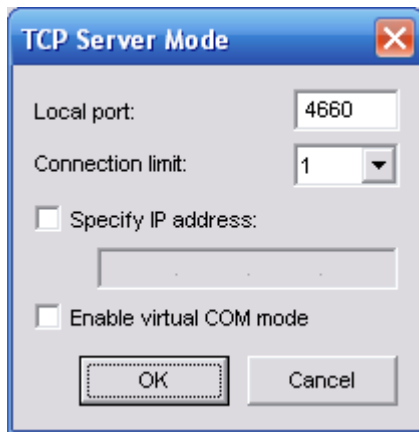

TCP Server mode

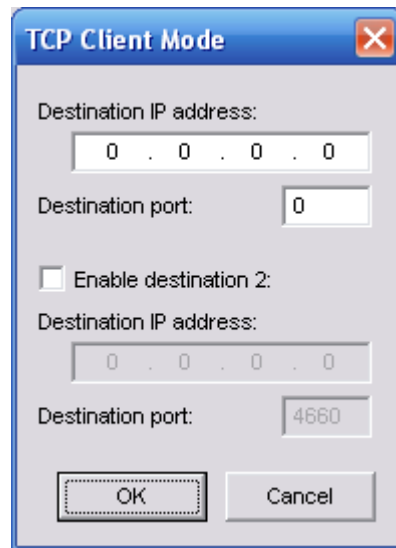

TCP Client mode

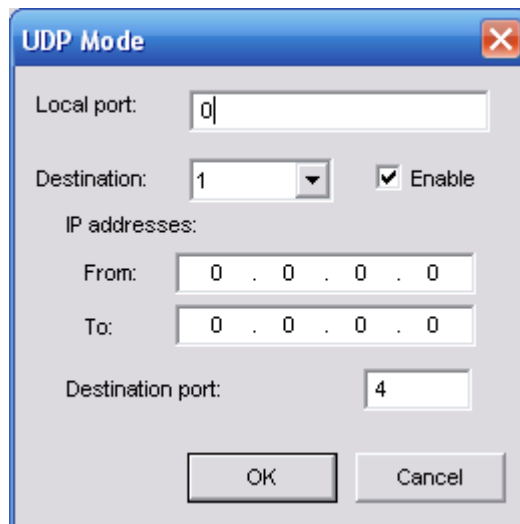

UDP mode

3 . COM port property: it mainly represents the working parameter of the serial port setting, including: serial-port working type, baud rate, data bit, stop bit, parity bit, data packet delimiter and flow control, etc.

### B3.4.3 Locate

The user can apply this function to locate a device when he knows it's IP address, but doesn't know its position. If a device is selected, the device will appear with singing by which the user can locate the device through the submenu option **Locate** or clicking the **Locate** button on the toolbar.

### B3.4.4 Reset

The device should be restarted after a successful modification of parameter configuration. And the user can carry out a restart through the submenu option **Reset**.

### B3.4.5 Erase Flash

Some devices are supplied to the user with a certain capacity of Flash memory to save the user's data. And the user can erase the Flash through the submenu option **Erase Flash** or clicking the **Erase Flash** button on the toolbar when the memory capacity is to be used up or the history data are unnecessary to be saved.

### B3.4.6 Import Setting ...

If a network has a large number of devices which are used for a same purpose, it would be very complicated to carry out the parameter configuration for each of the devices in the network one by one, while the user can import the parameter information of a standard parameter file directly into all the devices of the network through the submenu option **Import setting ...** or clicking the **Import setting ...** button on the toolbar, thus the work procedures can be largely reduced, shown as the figure below:



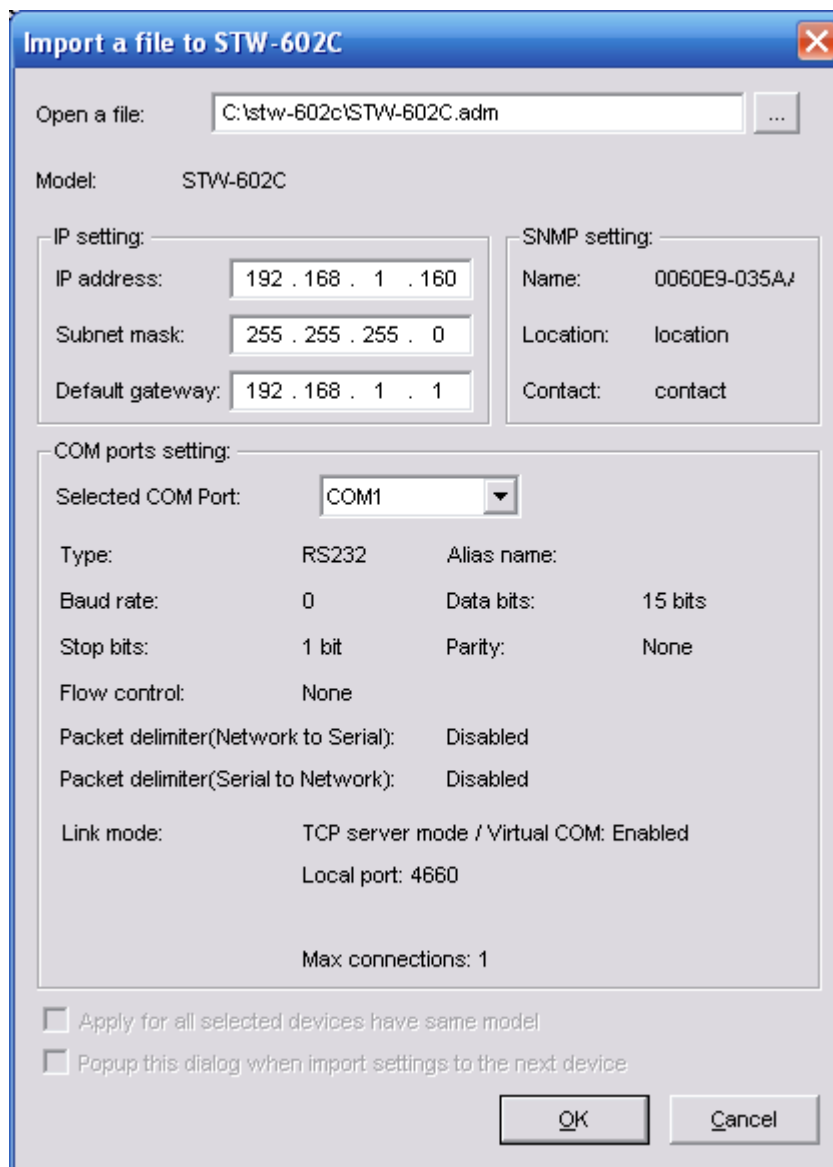

The user can also select several devices at one time, and lead the parameter information of a standard parameter file into all the selected devices by selecting **Apply for all selected devices have same model**.

### B3.4.7 Export Setting...

If a network has a large number of devices which are used for a same purpose, it would be very complicated to carry out the parameter configuration for each of the devices in the network one by one, while the user can save the parameter information of a standard device into a parameter file through the submenu option **Export setting...** or clicking the **Export setting...** button on the toolbar, thus the parameter information can be led in over again from this parameter file when the user is to carry out a configuration for any other device, shown as the figure below:

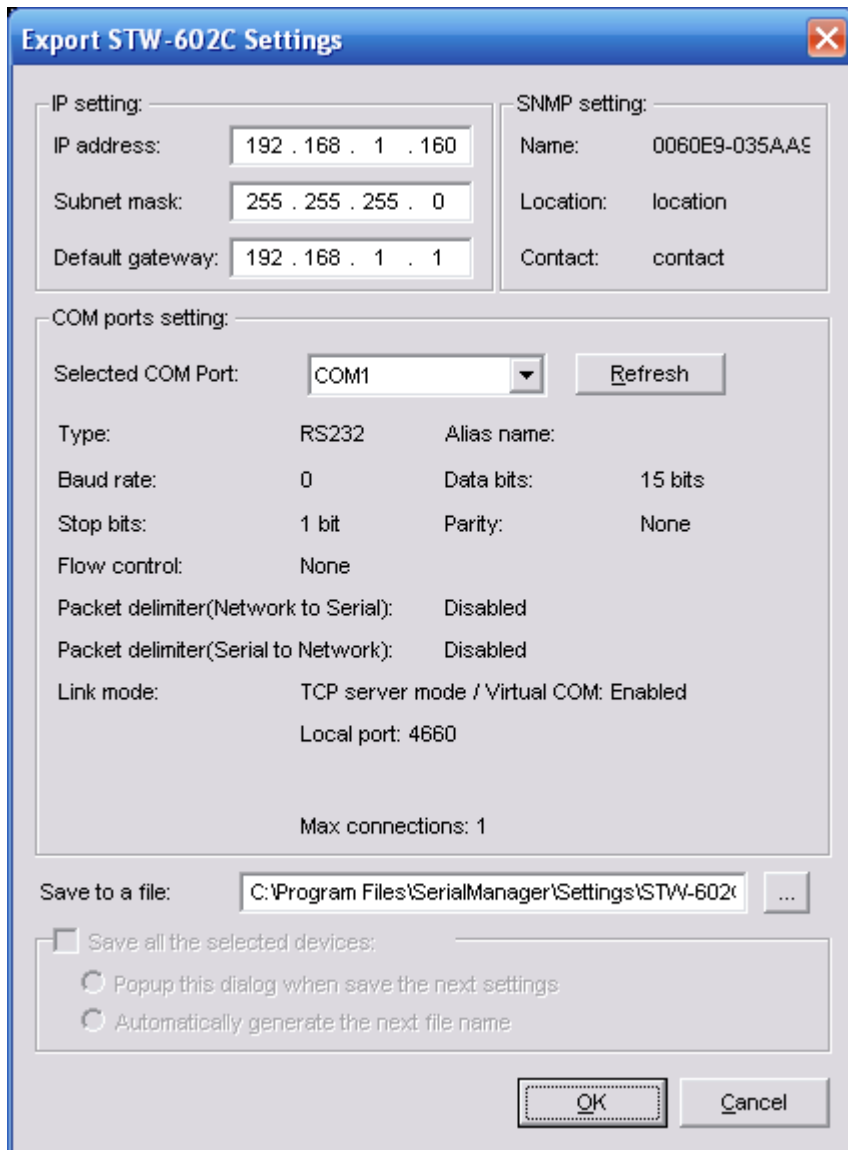

The user can also select several devices at one time, and save the parameter information of these selected devices into a designated parameter file by selecting "Save all the selected devices".

### B3.4.8 Virtual COM

Some devices are supplied with the function of virtual serial port, and the user can carry out any related setting through the submenu option "Virtual COM", shown as the figure below:

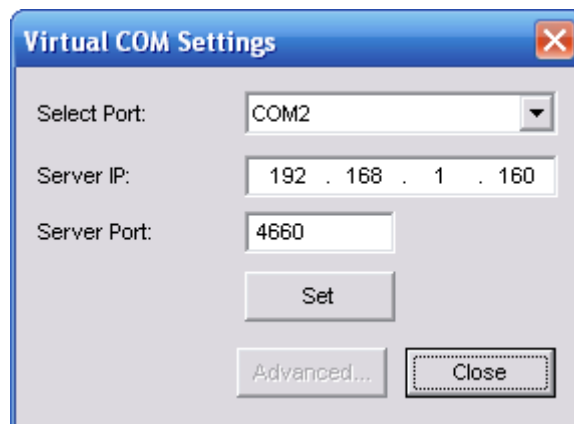

### B3.4.9 Configure by IE

Some devices are supplied with build-in Web servers, and the user can carry out any parameter setting

directly through the submenu option **Config by IE**, shown as the figure below:

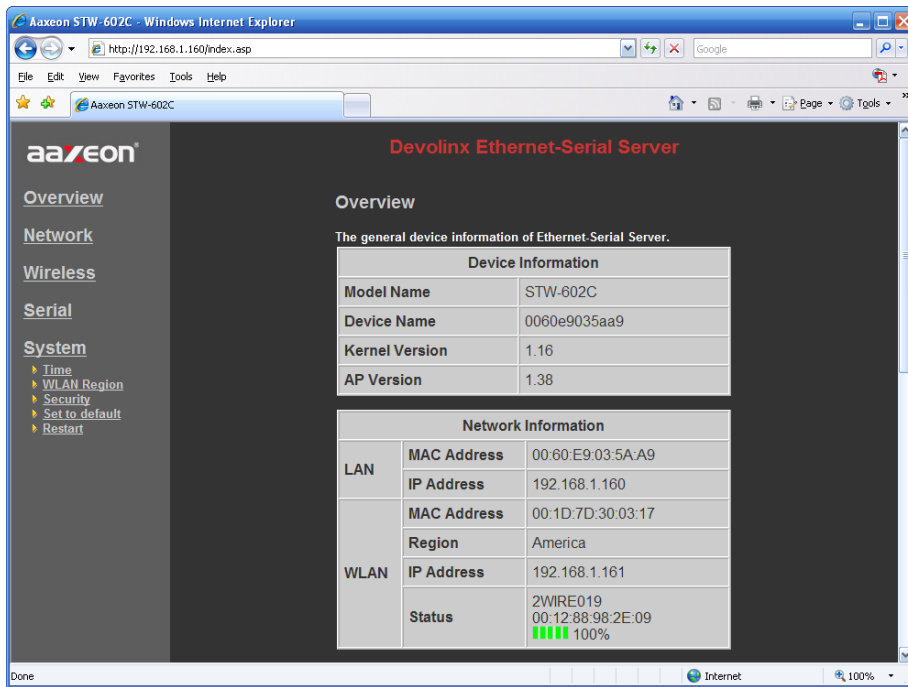

### B3.4.10 Option

The option is mainly applied to setting some common work rules of SerialManager utility, such as: search for the time interval of a network device, or whether to display any device indication and so on, shown as the figure below:

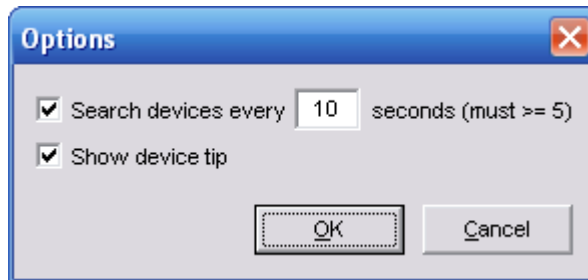

### 3.5 View

The user can select a display mode of the network device according to his/her own requirement through the menu option "View", such as: display in sequence of device module name, or display in sequence of IP address and so on, shown as the figure below:

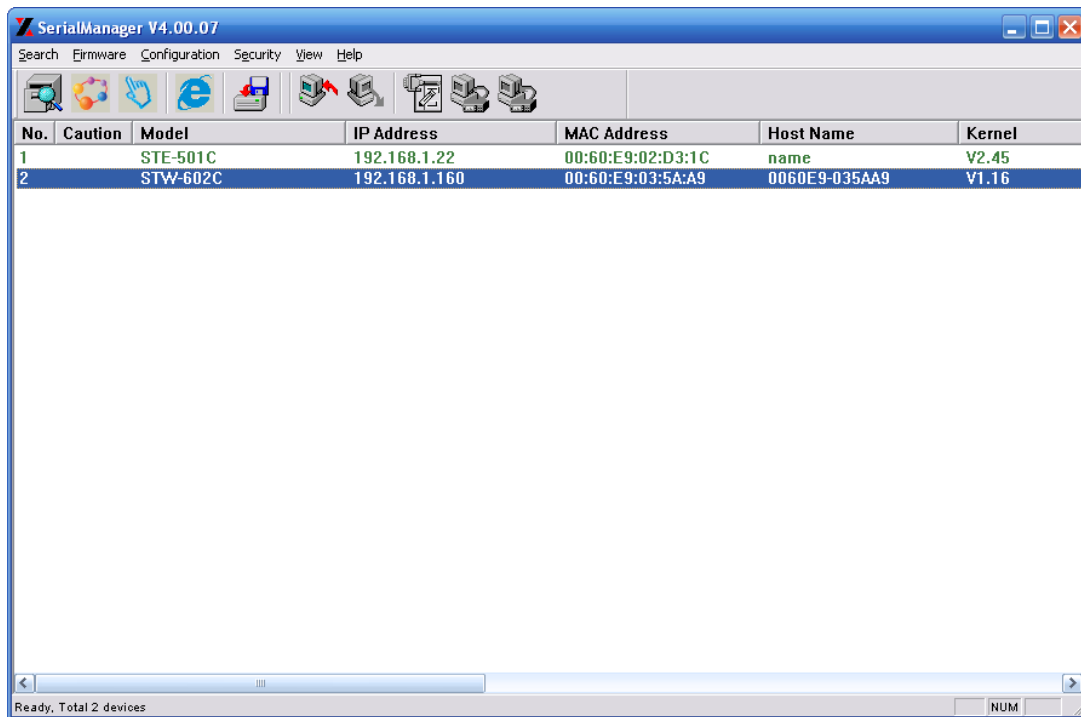

### B3.6 Help

This function is mainly applied to displaying some help information of the SerialManager utility, shown as the figure below:



## Appendix C. Upgrading System Software

Updated version of firmware can be downloaded from [www.aaxeon.com](http://www.aaxeon.com).

### C.1. System Upgrading Procedures

Follow the upgrading procedures below for the latest firmware.

- Make sure the PC and STW-602C on the same network. Use command “ping” or “SerialManager” utility program to verify their availability
- Edit “dll.bat ” to fit the system requirements, Be sure to save all modifications
- Run dll.bat ,or type command and parameters by linux\_dl\_v2.exe, the following screen shall appear:

*linux\_dl\_v2.exe zImage.bin 192.168.1.160* (device’s IP is 192.168.1.160)

\* **Tips** : “linux\_dl\_v2.exe” is the upgraded executing file(can find on setup cd) and **zImage.bin** is the name of the firmware file; **xxx.xxx.xxx.xxx** is the IP address of STW-602C.

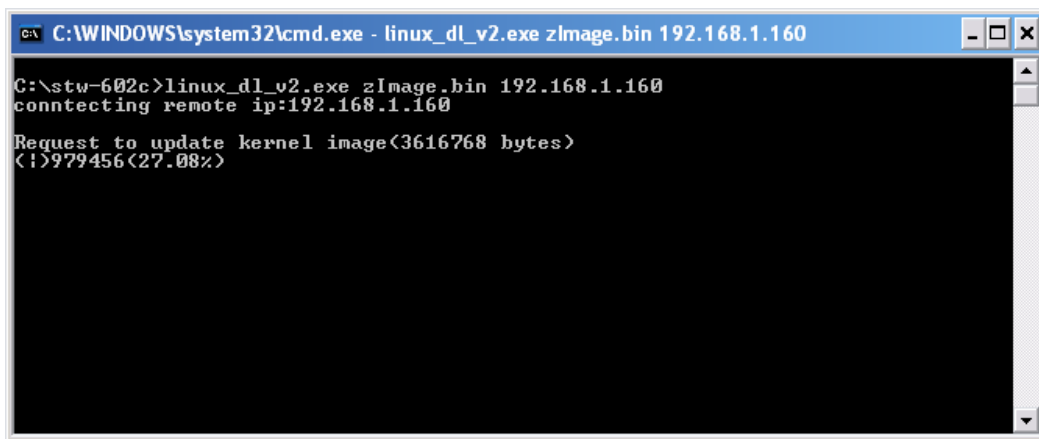

```
C:\WINDOWS\system32\cmd.exe - linux_dl_v2.exe zImage.bin 192.168.1.160
C:\stw-602c>linux_dl_v2.exe zImage.bin 192.168.1.160
connecting remote ip:192.168.1.160
Request to update kernel image(3616768 bytes)
<|>979456<27.08%>
```

Fig 81. Start firmware upgrade procedure for STW-602C

STW-602C shall automatically perform the download at first phase, and restart after downloaded process at secondary phase

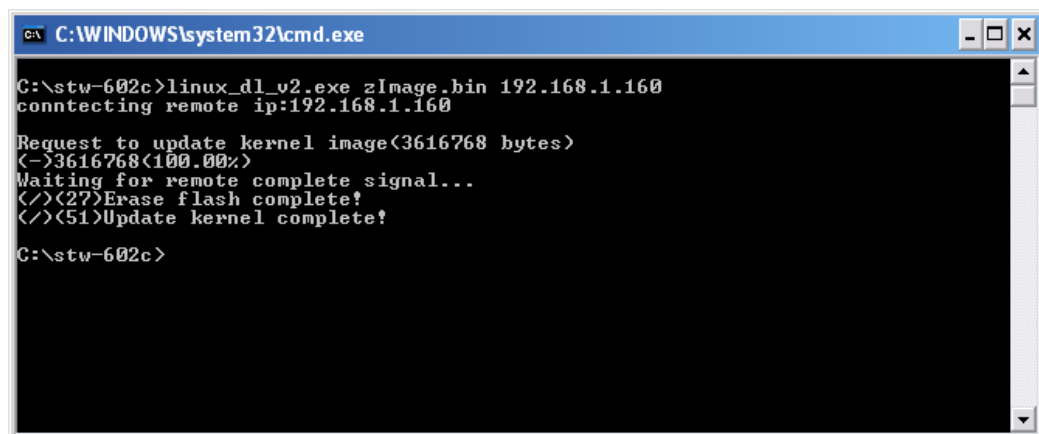

```
C:\WINDOWS\system32\cmd.exe
C:\stw-602c>linux_dl_v2.exe zImage.bin 192.168.1.160
connecting remote ip:192.168.1.160
Request to update kernel image(3616768 bytes)
<->3616768<100.00%>
Waiting for remote complete signal...
</><27>Erase flash complete!
</><51>Update kernel complete!
C:\stw-602c>
```

Fig 82. Connected & downloading process for STW-602C’s Upgrade

### C.2. Critical Issues in Upgrading Process

If the upgrading is successful, STW-602C shall re-program the flash memory, and the buzzer will beep before restarting. It takes around 5 seconds to complete the re-programming. **If an error occurs during the**

process, STW-602C will clear the corresponding memories, and the system will remain the same as the one before the upgrading process.

## Appendix D. Specifications

### D.1. Hardware Specifications

<b>System</b>	
CPU	150MHz RISC with MMU support
Memory	Flash: 8MB, 2MB for Bootloader / SDRAM: 16MBytes.
Interface	Mini-PCI Slot (for Wireless Module)
Watchdog	Hardware Watchdog Reset
Debug Port	CPU Build in Com.
<b>Wireless LAN</b>	
Protocols	Compliance for IEEE802.11b/g Modulation Type: CCK, DQPSK, DBPSK, OFDM (11g)
Topologies	Infrastructure, Ad-Hoc
Security	WEP 64-bit/128-bit data encryption WPA Compatible (TKIP/AES Encryption)
RF Performance	Tx Power 11b: 14dBm / 11g: 13 dBm Rx Sensitivity: -66 dBm @ 54 Mbps, -80 dBm @ 11Mbps Transmission Rate: 54 Mbps (max.) with auto fallback Transmission distance: Up to 300 meters (@12 Mbps, in open areas) Mobile for Fast Roaming
Interfaces	Reverse SMA Connector for Antenna
<b>Network</b>	
Protocol	10/100M Auto-Negotiation Fast Ethernet
Interface	RJ-45 Connector with 2LEDs Protection: Built-in 1.5 KV magnetic isolation
Application	Configuration with Telnet Protocol
<b>Serial</b>	
Protocols	Support RS232/485/422 & Software Selection
Interface	Terminal Block Connector –TB model (with 12KV ESD) D-sub 9-pin Connector –DB Model (with 12KV ESD)
Parameters	Baud Rate: 1200–921Kbps Parity Check: None/Odd/Even/Mark/Space Data Length: 7/8 Bit Stop Bit: 1/2 Flow Control: None/ Software: Xon/Xoff / Hardware: RTS/CTS
<b>Power</b>	
Input	DC 9V-48V
Consumption	4.5 W max @Tx Mode
<b>Mechanical</b>	
Dimensions	HxWxD: 90mm x 45mm x 75mm
Casing	Metal Housing for IP50 Standard

## Environmental

Operating Temperature	0 to 65°C (32 to 140°F), 5 to 95% RH
Storage Temperature	-20 to 85°C (-4 to 185°F), 5 to 95%RH

## Regulatory Approvals

EMC	FCC/CE
Safety	UL
Warranty	5 Years

## D.2. Software Specifications

### Software

Protocol	ICMP, IP, TCP, UDP, DHCP Client, Telnet, DNS, SNMP, HTTP, SMTP, SNTI
Utility	Virtual COM Utilities for Windows 98/2000/XP/2003/Vista Configure Utilities: Supported for Windows 98/2000/NT/XP/2003/Vista
Configuration	Web browser Telnet Console Windows utility
Buffer Size	TCP receiving buffer size = 8K bytes TCP transmitting buffer size = 16K bytes RS-232/RS-485 receiving buffer size = 4K bytes RS-232/RS-485 transmitting buffer size = 4K bytes

## D.3. Pin Assignments

DB9 male connector pin assignments for Serial

DB9				
	Pin#	RS-232	RS-485	RS-422
	1	DCD		
	2	RXD		T+
	3	TXD	Data+	R+
	4	DTR		
	5	SG (Signal Ground)		
	6	DSR		
	7	RTS	Data-	R-
	8	CTS		T-
	9	RI		



Terminal block pin assignments for Serial and Power

5-pin for serial connections		RS-232	RS-485	RS-422	3-pin for Power input		
	<b>SG</b>	GND	GND	GND		<b>FG</b>	FG
	<b>RTS/R-</b>	RTS	Data-	R-		<b>Vin-</b>	GND
	<b>TxD/R+</b>	TxD	Data+	R+		<b>Vin+</b>	9~48V
	<b>CTS/T-</b>	CTS		T-			
	<b>RxD/T+</b>	RxD		T+			

- \* Note: RS-485 2 or 4 pins assignments of DB9 connector are different from those of Mini DIN connector.

### D.4. Beep & LED Status

#### Startup status

Message	Description
---------	-------------

^==^=====^^^ (5sec) Startup OK and AP firmware is enabled

- \* Buzzer indication: “ ^ “ : Beep twice “ = “ : Beep off

#### Wireless Signal Strength status

The BSS quality can be detected by LED indicator on STW-602C. On running time, pressed default key and then released, one of the specified actions below shall be done that depend on the released time after you heard how many beeps. BSS quality is indicated by count of LEDs as shown below.

#### RSSI LEDs Message:

○ Off ● On ☼ blinking

Operations		Status*	LED1	LED2	LED3	LED4	LED5
<b>Connecting</b>	Search AP (sequentially blinking)	☼	☼	☼	☼	☼	☼
	Connected AP/ Get assigned IP	☼	☼	☼	☼	☼	☼
	Not matched SSID	☼					
	Not available IP	☼	☼				
<b>Connected</b>	Signal Strength is less 20%	●					
	Bad Signal Strength (20%)	●	●				
	Poor Signal Strength (40%)	●	●	☼			
	Fair Signal Strength (60%)	●	●	☼	☼		
	Good Signal Strength (80%)	●	●	☼	☼	●	
	Excellent Signal Strength (100%)	●	●	☼	☼	●	●

- \* Note: The lowest LED is indicated for STATUS at STW-602C’s front plate.

#### WLAN LED Message

Message	Description
LED Off	No data is transmitting on Ethernet
LED blinking	Data is transmitting on Ethernet

### COM Port LED Message

Message	Description
LED off	No data is transmitting on COM port
LED on blinking state	Data is transmitting on COM port

### RUN LED Message

Message	Description
LED blinking (rate: 0.5Sec)	AP firmware is running