

H.264 NETWORK Embedded DVR

USER MANUAL



CONTENT

1	INTRODUCTION	3
1.1	Main Feature	3
1.2	Product features	3
1.2.1	Parameter	3
1.2.2	Basic working parameter	5
1.3	ENTIRONMENT ADAPTABILITY	5
2	Device operation manual	6
2.1	Remote key instruction	6
2.1.1	Remote control	6
2.1.2	Mouse Operation	7
2.1.3	Menu Tree	9
2.2	System Operation	10
2.2.1	User Login	10
2.2.2	GUI OPERATION	11
2.2.2.4.1	SYSTEM LANGUAGE SETUP	16
2.2.2.4.2	DATA/TIME SETUP	16
3	IE OPERATION	27
3.1	FEATURE	27
3.2	USER LOGIN	27
3.3	OPERATION INTERFACE	28
3.3.1	LIVE	28
3.3.1.1	PTZ CONTROL	28
3.3.1.1.1	ZOOM	29
3.3.1.1.2	PTZ PRESET	29
3.3.1.2	PLAY	29
3.3.1.3	OTHER OPERATION	29
3.3.2	REPALY	30
3.3.3	SETUP	32
3.3.3.1	RECORD	32
3.3.3.2	ALARM	33
3.3.3.3	PTZ	34
3.3.3.4	NETWORK	34
3.3.3.5	SETTING	35
3.3.3.6	HOST INFO	36
4	DVR Installation Guideline	37
4.1	Product Overview	37
4.2	HDD Installation	42

1 INTRODUCTION

1.1 Main Feature

DVR-D7704HT/D7708HT is developed base on HI3511 hardware platform. D7704HT is 4channel CIF resolution digital video recorder and D7708HT is 8channel DVR. Both of them have local recording, playback, support triple code remote network surveillance, data backup, parameter setting, motion detection, I/O alarm setting, PTZ and USB mouse.

1.2 Product features

- ◇ H.264 compression
- ◇ Two USB interface, USB2.0 for data backup, USB1.1 for mouse operation.
- ◇ 3.5" SATA HDD.
- ◇ Special file system for security.
- ◇ 16 nature translucence GUI, note for menu selected
- ◇ optimized four channel simultaneously playback, (8ch just support one channel playback)
- ◇ double level user management

Support the live view, parameter setting and copy playback video via network.

1.2.1 Parameter

Model: D7704HT / D7708HT		
Item	Device	performance index
System	Language	Chinese/English
	GUI	Graphic menu
	password	user password, administrator password
Video	Video in	4ch/8ch complex video input 1.0Vp-p , impedance75Ω, BNC
	Video out	2ch complex video output 1.0Vp-p , impedance75Ω, BNC
	Video display	1/4channel switch/8ch 1/4/9 switch
	Video standard	PAL, 25f/s, CCIR625line, 50scene NTSC, 30f/s, CCIR525line, 60scene
Audio	Audio input	4ch/8ch audio input, impedance600Ω, RCA
	Audio output	1ch audio output, impedance600Ω, RCA

	Basic electricity output	Linearity electricity
	Record style	Audio video recorded simultaneously
	Audio compression	ADPCM
Picture proceeding and store	Picture compression	H.264, (VBR) / (CBR)
	Picture resolution	CIF/HD1/D1
	Streaming style	ISO14496-10
	Audio style	ADPCM
	Video code rate	CIF: 384~768 Kbps HD1: 512~1024 Kbps D1: 512~1024 Kbps
	Audio code rate	32KB/s
	Data storage	
Alarm	Alarm input	4/8 alarm input
	Alarm output	1 alarm output
Connector	Servial interface	Support 1 RS232
	Servial interface	Support 1 RS485
	Network interface	RJ45, 10M/100M
USB	Mouse	USB1.1,
	Udisk	USB2.0
VGA	VGA	1 VGA (select)
Software	PC playback	Playback video file
Software upgrade	Support USB,network firmware upgrade	
ohters	voltage input	AC:110~240V
	Voltage output	DC: 19V@3A
	Voltage output	DC: 12V@1A (For D7704HT)
	Power	6W without HDD
	Working temperture	-10----60℃

1.2.2 Basic working parameter

item	parameter	remark
Voltage input	19V	DC 19V。
Voltage outputfor camera	12V (+/-0.2)	12V, 1A(For D7704HT)
Video impedance input	75Ω	75Ωeach channel。
Video output	1Vp-p	1Vp-p CVBS signal
I/O	0—2V	Low voltage alarm
	5V-30v	Hight voltage alarm
RS232		serial port, for extend use
RS485		Connect to PTZ, (Pelco-D, Pelco-P)
SATA HDD		One SATA with all capability

1.3 ENTIRONMENT ADAPTABILITY

For the saftly using DVR and prolong device life, please pay attention on following detail:

- 1) When installing device, please comply all the electric product safty criterion;
- 2) Power and ground:
 - ◆ Do not touch the power and DVR with a wet hand
 - ◆ Do not drop liquid on DVR
 - ◆ Do not put others on DVR
 - ◆ Please using soft dry cloth when clean DVR, do not using chymistimpregnant
 - ◆ When the power line connects with jack, even don't startup device. There is still have voltage
 - ◆ If you do not use device for long time, please take the power line away from jack.

2 Device operation manual

In device operation, the enter key on remote control has the same function with mouse left click.

2.1 Remote key instruction

2.1.1 Remote control



Handheld IR Controller Key Functions:

【0—9】 keys: During setup, number keys are used to input values.

For viewing channels 1,2,3 and 4, use 1,2,3 and 4 on numeric keypad respectively.

【+】 , 【-】 keys: During setup, plus and minus are used to select next or previous values.

▲, ▼: Up, Down directional keys: Move selection up and down in setup menu.

◀, ▶: Left, Right directional keys: Move cursor left or right in setup menu.

【Enter】 key: During setup, select and save entry

During Playback and preview, displays the channel name, text number, driver name, event sensor item and time, year/month/date, time, GPRS/GPS info. on the screen.

【PLAY】 : Starts/Resumes playback from any other mode (FF, RR, Frame by Frame etc)

【SLOW】 : Reduces playback speed to 1/2X、1/4X、1/8X、1/16X mode. Press PLAY to return to normal playback speed.

【PAUSE/STEP】 : Freezes playback to single frame and can advance one frame at a time.

To advance the frame press Pause/Step to move frame by frame.
Press EXIT to return to normal playback speed.

【FWD】 : Fast forward the video while playback.X1, X2, X3, X4 modes available.

PressFWD to switch, press **【PLAY】** to return to normal speed;

【REV】 : Reverse the video while playback, 1X,2X,3X,4X four modes are available. Press

REW to switch, press **【PLAY】** to return to normal speed;

【POWER ON】: Reset the MDVR to Power on and Power off mode. (standby and start up);

【LOGIN/LOCK】 : If the security is enabled in the setup, use LOGIN/LOCK key to enter the user setup. It is important to remember the password due to without restoration function. Log in (to enter into “User ID select” and “Password” input interface) and lock functions (To exit setup and operation)

【EXIT】 : Exit to the preview or return to the last menu;

【RECORD】 : Start manual record

【STOP】 : Stop manual record

【SETUP】 : Enter into setup interface and setup the system parameters



【PTZ】 : PTZ control, press this key to enter into PTZ control interface when at single live view;

【ASISTANT】 for future use

2.1.2 Mouse Operation

You can use mouse to make operation of the menu except IR remote controller. (The operation usage is the same as PC Windows).Please inserts the mouse into USB1.1.

Click right key	Enter into main menu: Click the right key on the live view.
	Exit the present menu: It won't save the settings if you click the right key to exit.
	Exit the playback interface: Click the right key to exit when you are playback.

Click left key	Click the left key to enter into the setting interface.
	Click the left key to zoom in the window on the live view and playback video. Double click the left key can exit to the live view and playback multi-window interface.
	<p>1. Volume adjustment, color adjustment, PTZ setting and VGA border operation. It is for setting the single channel for volume adjustment, PTZ control and color adjustment. If it is multi-window, please use the left key to select the single window.</p> <p>2. The remark when click the left key for volume adjustment, color adjustment, VGA border is as follow:</p> <p>a. There is  and  on the PTZ setting to adjust parameter, click it can make the setting for PTZ.</p> <p>b. There is a sticker to show the volume on the volume adjustment interface. Move the mouse to the corresponding position and click the left key, The right side of sticker will show the volume, click "x" to exit;</p> <p>c. Color adjustment and VGA border operation can refer to the volume adjustment interface operation.</p>
	When there are many options in the option frame, click left key to ball out down-pull menu.
	To click the left key on the playback interface can make >> means forward, << means rew, >> means Slow play, > means frame play, > means Play, X means exit.
Click left or right key	<p>1. In the input frame, click the left key or right key can activate the keyboard. Click the right key can make the switch of Chinese and English on the soft keyboard. The number, symbol, english can be input by clicking the mouse.</p> <p>2. Pingyin also can be input by the softkeyboard when enter Chinese, the method is the same as IR remote controller. You can use the left/right key to turn over the page when check on Pingyin/Chinese word.</p> <p>3. When input number, click the right key, the number soft keyboard will bob up firstly, and then use the left key to select the corresponding value. Also click the left key to exit the number keyboard.</p>
Mouse move	<p>1. Press the left key to move the mouse can adjust the parameter on the volume, color, VGA border interface. And the corresponding parameter will be display at the same time.</p> <p>2. In the Motion Detection setting interface, you can use the left key to drag the frame to set the motion detection area.</p>

2.1.3 Menu Tree

You can control the DVR by a lot of menu operation. This tree will show you the menu structure and it will be in details in after chapter.

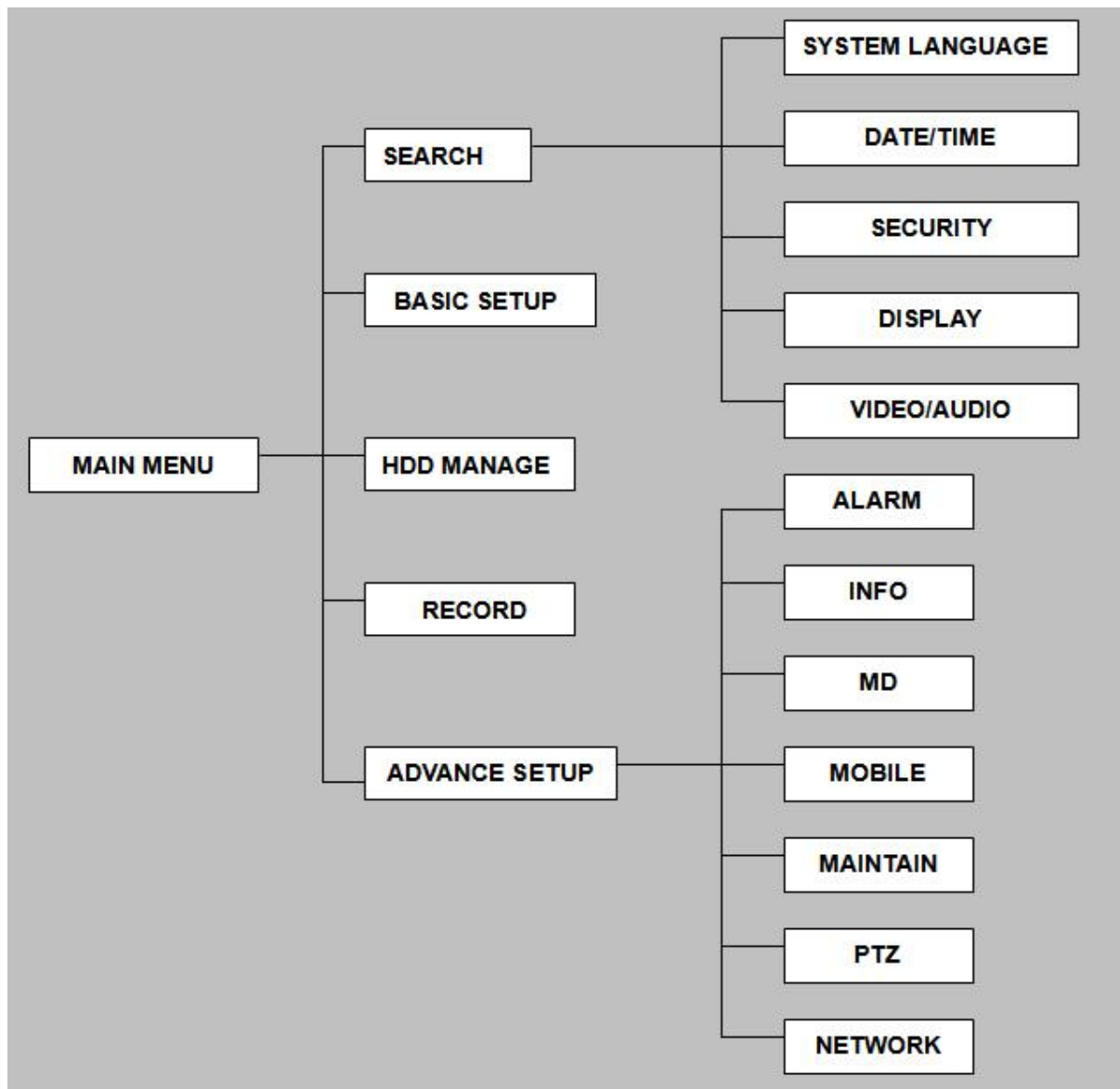

2.2 System Operation

2.2.1 User Login

1. START-UP

Connect the DC19V/3A adapter to DVR. When start up the DVR, 【POW】 LED will be on and 4 images will be display on the screen. If it has setup ignition recording or time recording, the system will record automatically and the corresponding LED will be on, the system work normally.

Remark: If there is no HDD in device, or device didn't read the HDD, it will display an 【H】 in live view.

2. SYSTEM LOGIN

When you login, you will find the window as follow if the password is enabled, Input device ID and user password via numeric key-board, and you access to main menu via press 【Apply】

Remark: default device ID is: 00000, and the password is :user password is 000000 and Admin password is 020818, in order to manage the device more convenience, please setup the user password and change the device ID in the base setup. You can setup user and admin password, Administrator has all authorities, operator has limited authorities who they can only watch, playback, please change the unit ID and default password in time for system security.



Unit ID: You just need to enter the unit ID as the right frame.

Password: enter the admin password or user password.

2.2.2 GUI OPERATION

The main menu include “SEARCH”,”RECORD”,”HDD”,”BASIC”, “ADVANCE”,and“Exit”.



Remark: You must after pressing “APPLY”to make the setting for submenu valid.It will no use when exit directly.This DVR have a special feature is: when you move the mouse to everwhere, there will have the explanation information showed autoly.

2.2.2.1 RECORD SEARCH

Move the cursor to **【RECORD SEARCH】** (Icon highlighted when selected) ,press **【Enter】** to enter into the setting interface.

RECORD FILE:You can adjust the checking date and time,press **【Enter】 【+】/【-】** or input the number directly to adjust the year,month,date.After finishing the time setting,move the cursor to “SEARCH” and press”APPLY”,can see the recording status of this date.As follow:



Intruaction:

1. **MONTH:** It will show all the recording status in this month. Green means normal recording, Red means alarm recording, Grounding means no recording. Click any date in this frame can search the recording status of that day,the searching result will be showed in the below date frame.

2. **DATE:** It will show all the recording status in this day, you can playback the record file in this period via click the corresponding period.

PLYBACK:You can press **【Enter】【+】/【-】** or input number directly to setup playback time.After setting,move the cursor to “PLAYBACK”, and then press”APLLY”to enter into video playback of that time.Also you can select any period of time in the video status frame after searching,press”APLLY”to enter into the video playback of this period.

FILE LIST: Enter into the video file list interface of the selected date.

LOG SEARCH: Enter into the log seaching interface.

EXIT: Exit”video search” to back to the previous menu.

1. FILE LIST

Setup the searching date, after pressing “SERACH”,move the cursor to “FILE LIST” and press”APPLY”to enter into the video file list of this date.

CHANNEL: There is 1,2,3,4 and all channel, totally 5 options. Press **【Enter】**or **【+】/【-】**to select.

TYPE: There are all,normal and alarm,totally 3 options.Press **【Enter】** or **【+】 / 【-】** to select.



Instruction:

1. **【FILE LIST】**, “CHANNEL”is the recording file which belong to which channel, “SIZE” is display the size of this file (Unit: MB), “TYPE” is display the type of recording file, there are two types: normal and alarm, press“BACKUP”button can export the selected files to USB storage;

2. After moving the cursor up and down and select the files, and press **【APPLY】** to enter into playback interface. If the all channels have recording files, it will playback all windows at the same time;

3. If setup as “on” in the **【RECORD TIME】** in **【BASIC SETUP】**, it will show the date/time

when playback record file; If setup as “off”it will not display time;

4. When playback, can press **【SLOW】** to play slowly; press **【FORWARD】**、**【REVERSE】** to speed、reverse play; also can press**【PAUSE/STEP】**to pause and frame by frame play; Press **【Exit】** to exit from playback and return to the former menu;

5. When finished playback files, it will return to the file list interface.

2. BACKUP

You can use USB for backup, should insert USB device into the USB2.0 port before backup files. And it is support USB OTG.

You can select the recording file by direction keys or **【+】**、**【-】** , and press **【Enter】** means selected OK (There is a “√” at the end of the selected recording files) and press **【Enter】** again the “√” will disappear that means cancel the select, we can start export the recording files after selecting, and press **【BACKUP】** to start to backup, as follow:

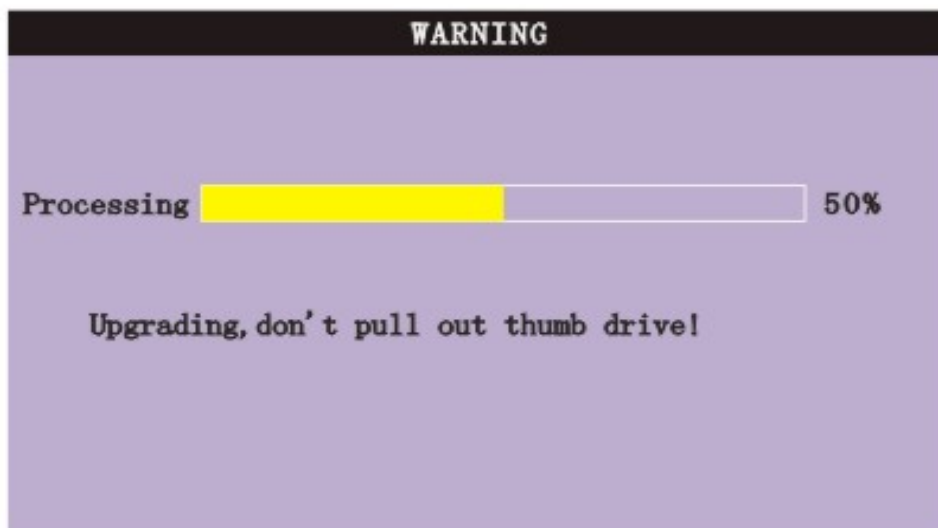

Instruction:

1. When the space in backup device less than recording file, the system will prompt “Space no enough”.

2. You can move USB device directly when backup finished.

2.2.2.2 RECORD SETUP

Move the cursor to **【RECORD】** (Icon highlighted when selected) ,press **【Enter】** to enter into the setting interface. Press **【Confirm】** and enter into the setup interface, and you can use direction keys and cursor to change the options.



CHANNEL: ON: Means the channel enable for recording.

RESOLUTION: Setup resolution and code rate for recording, there are HIGEST, HIGH, NORMAL three options, corresponding to D1、HD1、CIF resolution.

QUALITY : There are BEST, FINE ANDNORMAL three option, corresponding HIGHEST, HINGAND NORMAL data stream standard

AUDIO: ON: Means enable the audio recording for all channels, OFF: Means disable audio recording

REC.MODE:

POWER UP: Means the device will start recording when it startup.

TIME: Recording as the schedule, you can setup the schedule as you want as follow.

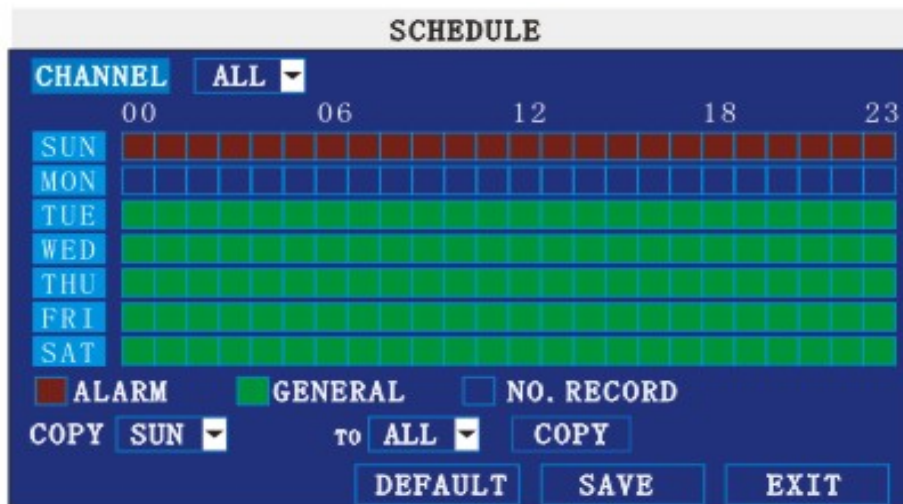

CHANNEL: You can select all channel or just one channel (blue means has selected)

WEEKLY: You can select all everyday, weekend, workday or each day(blue means has selected)

DAILY: There are ALARM, NORMAL, NO REC three modes, if you select this, that means all the day will record as this mode, and if you don't want some period to record, you can cancel it via **【Enter】** button, grounding means don't record, different color means different record mode: Red means alarm record, green means normal record, grounding means no record.

RECORD SIZE: There are 15min, 30min, 45min, 60min four options, that means it will pack as the mode you selected

Scroll to **APPLY** and press **ENTER** to save the new settings.

2.2.2.3 HDD MANAGE

Move the cursor to **【HDD】** (Icon highlighted when selected) ,press **【Enter】** to enter into the setting interface, and you can use direction keys and cursor to change the options.



HDD STATUS: There are three status available, normal, un-format, No HDD. If HDD can not run normally (including unformat and no HDD) , there is a **【H】** display on video live view.

OVERWRITE: ENABLE: means when HDD space less than 4G, it will delete HDD earliest recording file, and it will stop deleting when the space is 10G; DISABLE: means when HDD space less than 500M it will stop recording, and an prompt will display in live view “please shutdown and replace HDD”

FORMAT: Move cursor there to select device and press **【APPLY】** to start format

2.2.2.4 BASIC SETUP

Move cursor to select “BASIC SETUP” (The big icon means select ok)and press **【ENTER】** to enter into the system language setup interface.



Basic setup includes system language, time/date, security, display, video/audio and exit six options.

2.2.2.4.1 SYSTEM LANGUAGE SETUP

Move cursor to select “system language” (The big icon means select ok) and press **【ENTER】** to enter into the system language setup interface.



System language have Chinese and English two options, you can setup the language you want in here.

Remark: The device will restart when you setup system language success.

2.2.2.4.2 DATA/TIME SETUP

Move cursor to select “date/time” (The big icon means select ok) and press **【ENTER】** to enter into the date/time setup interface.

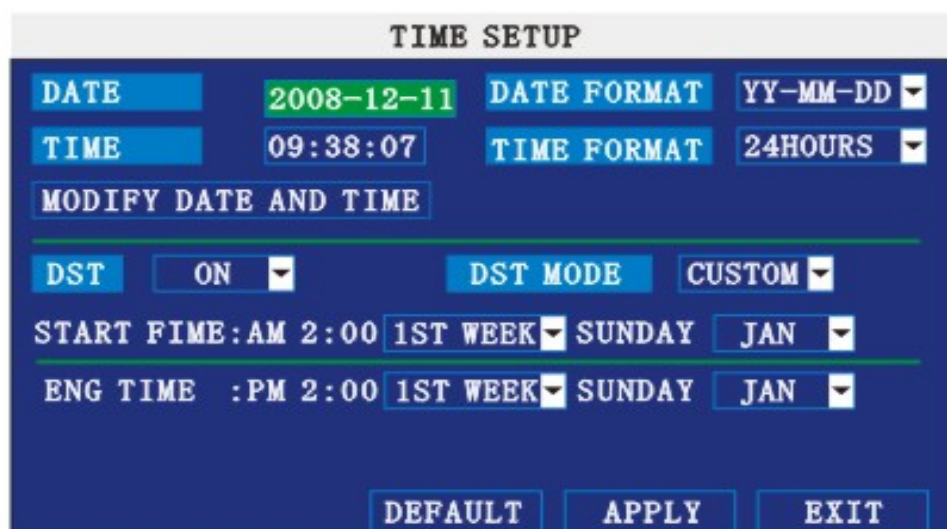

DATE: Setup system date via numeric key.

DATE FORMAT: Press ENTER to switch between the date patterns, there are YY-MM-DD

and MM/DD/YY two options.

TIME: Setup system time via numeric key.

TIME FORMAT: Press ENTER to switch between the date patterns, there are 12 HOURS and 24 HOURS two options.

Remark: You must move the cursor to the **【MODIFY TIME AND DATE】** and press **【APPLY】** to save it, otherwise it won't save the modify if you exit this interface.

DST: haven't finished yet.

2.2.2.4.3 SECURITY

Move the cursor to **【SECURITY】** (Icon highlighted when selected) , press **【Enter】** to enter into the setting interface.

SECURITY			
DEVICE ID	000010		
PASSWORD	ENABLE		▼
USER PASSWORD	*****	RE-ENIER	*****
ADMIN PASSWORD	*****	RE-ENIER	*****
		APPLY	EXIT

DEVICE ID: Press **【+】** / **【-】** or number key to setup the unite ID

PASSWORD: Press **【APPLY】** to start or close user password. If it is "ENABLE", you must input password when log in, otherwise, you can enter into main manu directly.

USER PASSWORD: Press **【+】** / **【-】** or numbe keys to setup user password.

ADMIN PASSWORD: Press **【+】** / **【-】** or press number keys to setup admin password.

2.2.2.4.4 DISPLAY SETUP

Move the cursor to **【DISPLAY SETUP】** (Icon highlighted when selected) , press **【Enter】** to enter into the setting interface.

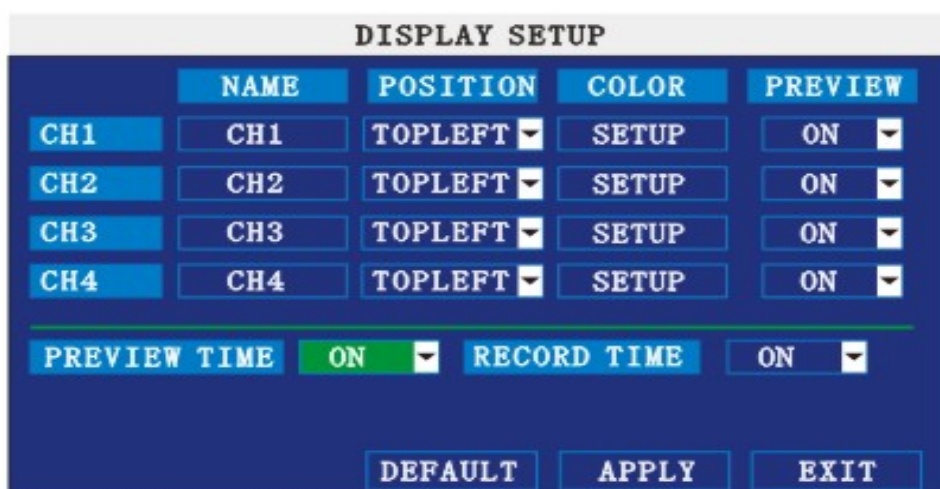

NAME: press **【Enter】** to enter into the setting interface.

POSITION:press **【Enter】** to switch name location,there are 5 options:bottom left, top left, bottom right, top right and OFF.

COLOR: press **【Enter】** to enter into setting interface, as following:

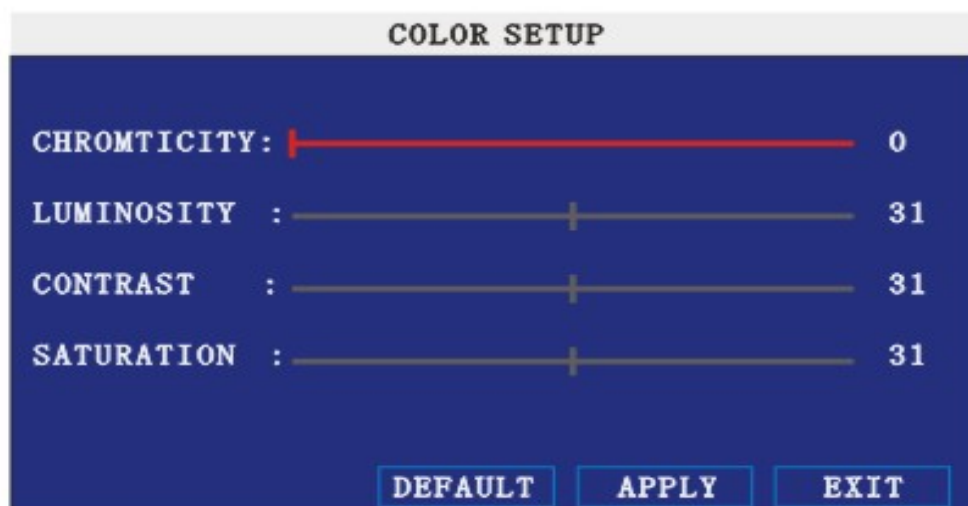

Press **【Enter】** or **【+】** **【-】** key or directly drag the cursor to set colors,including chroma,brightness, contrast and saturation, press **【APPLY】** to save the parameters.

PREVIEW: ON: Means the channel is allowed to view the live mode, OFF means not.

PREVIEW TIME: ON: Means insert clock in live view, OFF means not.

RECORD TIME : ON: Means insert clock in record file, OFF means not.

2.2.2.4.5 VIDEO/AUDIO SETUP

Move the cursor to**【VIDEO/AUDIO SETUP】**(Icon highlighted when selected), press**【Enter】** to enter into setting interface.

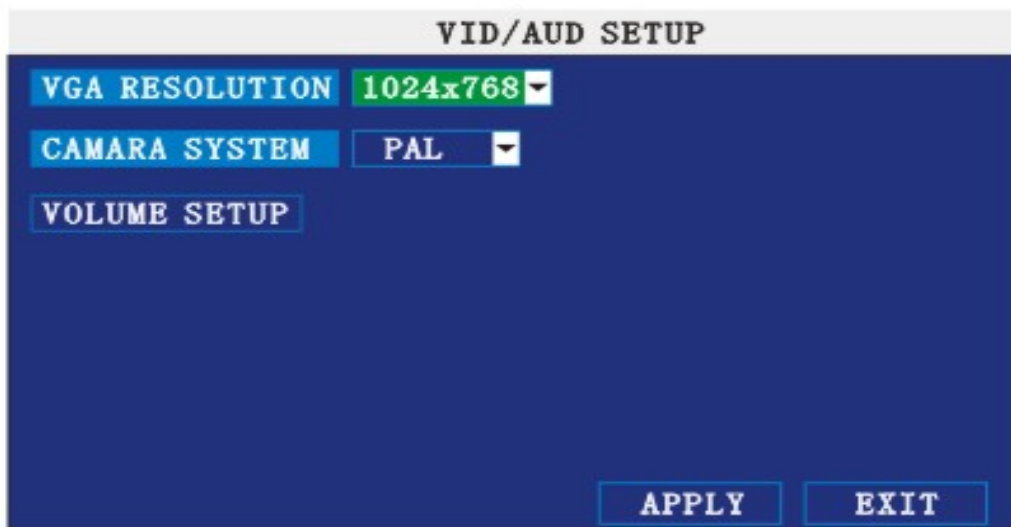

VGA RESOLUTION: press **【Enter】** key to setup the VGA resolution, there are 1024*768、800*600 and 600*480 three options.

CAMERA SYSTEM: press**【Enter】**to switch camera system, has PAL and NTSC two options

VOLUME SETUP: move cursor to**【VOLUME SETUP】**, press **【Enter】** to enter into volume setup interface, press **【+】 【-】** or number keys or directly drag the cursor to adjust volume.

2.2.2.4.6 EXIT

Move the cursor to**【EXIT】** (Icon highlighted when selected) , press**【Enter】**to back to main menu.

2.2.2.5 ADVANCE SETUP

Move the cursor to**【ADVANCE SETUP】** (Icon highlighted when selected) , press **【Enter】** to enter into setting interface.



Advanced Features include Alarm settings, system information, Motion detection, mobile phone monitoring, system maintenance, PTZ and network setting.

2.2.2.5.1 ALARM SETUP

Move the cursor to **【ALARM SETUP】** (Icon highlighted when selected) , press **【Enter】** to enter into setting interface.

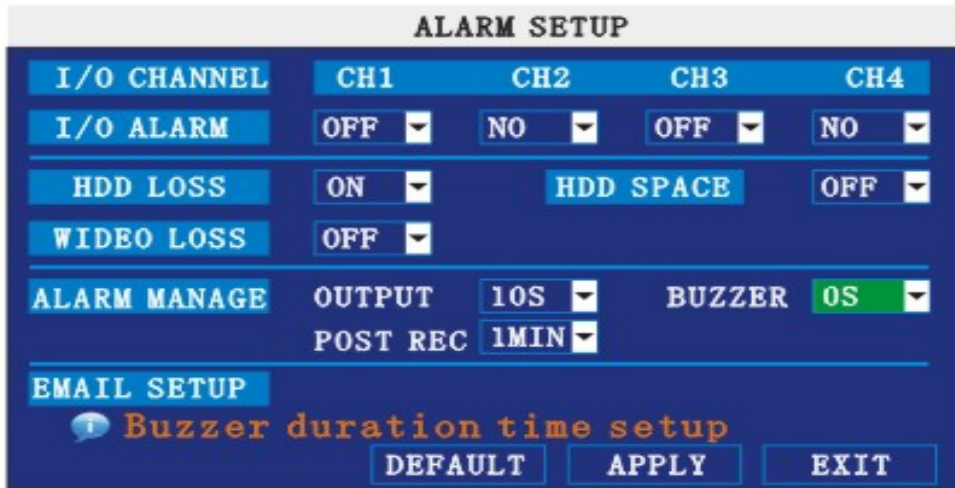

I/O CHANNEL: Each channel corresponds an I/O status, that is, when an alarm triggered, it will activate the corresponding channel to start alarm recording.

N.O: indicate I / O input level from high to low effective

N.C: indicate I / O input level from low to high effective

HDD LOSS: ON means it will trigger a alarm if there is no HDD, and it will display an **【H】** On the bottom left of channel 1 in the live view

HDD SPACE: ON: If the space less than 500M, there is a remark in live view: No enough space, please change HDD after shutdown.

VIDEO LOSS: ON: when one channel has no video input, it will display “video loss” in live view.

ALARM MANAGE: There are alarm output, buzzer and post REC three items.

OUTPUT: when an alarm triggered, the alarm output time will be:

0 second、 10 seconds,20 seconds,40 seconds and 60 seconds

● **BUZZER:** buzzer calling time setup when alarm triggered: 0 second,10 seconds,20 seconds,40 seconds and 60 seconds

● **POST REC.:** post recording time setup: 30 seconds,1 minute,2 minutes and 5 minutes

● **PRE REC:** Pre-recording time is fixed as10 seconds.

2.2.2.5.2 SYSTEM INFO

Move the cursor to **【SYSTEM INFO】** (Icon highlighted when selected) , press **【Enter】** to enter into setting interface, at this interface mainly display system hardware features and firmware version, include : device type, software version, MAC address、 serial number.

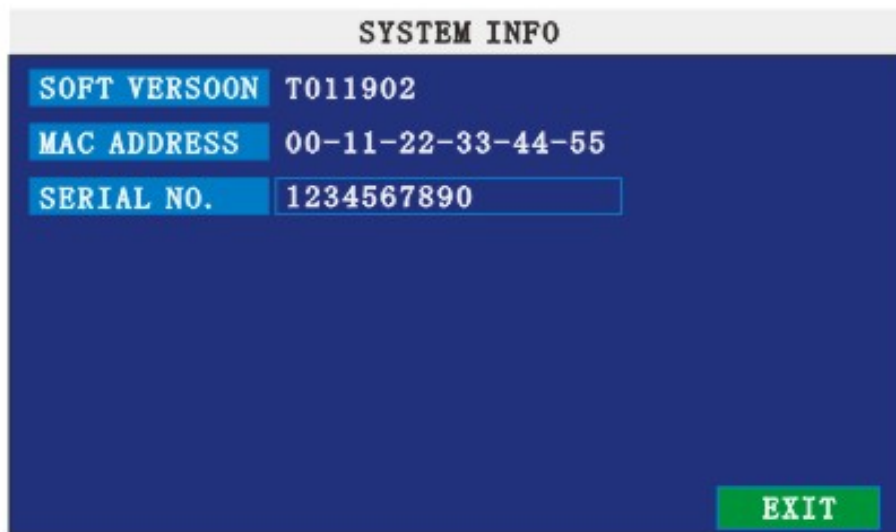

2.2.2.5.3 MOTION DETECT

Move the cursor to **MOTION DETECT** (Icon highlighted when selected), press **Enter** to enter into setting interface.

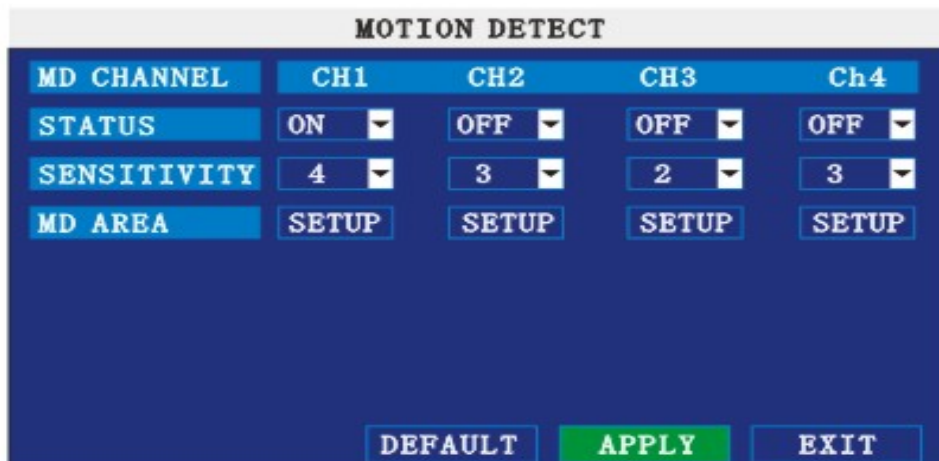

STATUS: Each channel has corresponding channel switch, press **Enter** to turn on or turn off the motion detection for each channel..

SNESITIVITY: each channel has corresponding sensitivity setting,including four standards high,higher,medium and low, press **Enter** key to switch

MD AREA: each channel has corresponding regional motion detecting setting,move the cursor to corresponding **setting**, press **Enter** to enter regional setting interface, red area means it have activated motion detection, transparent block means it have not activated motion detection.

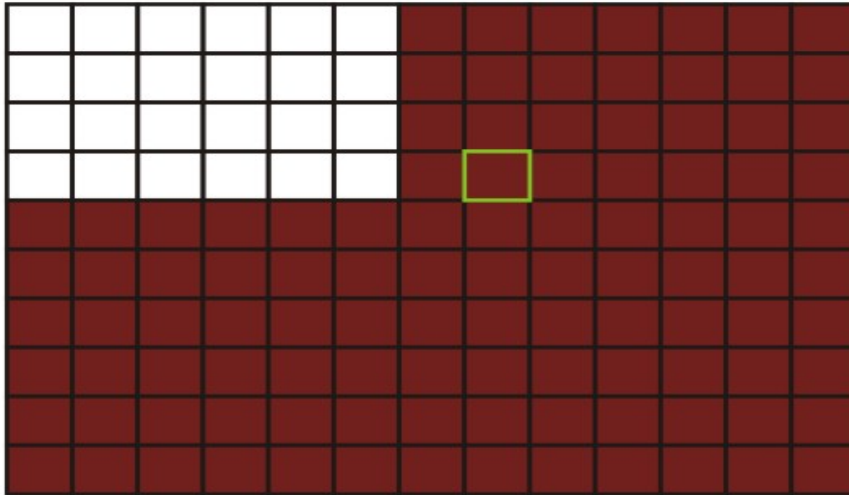

Move the direction key on remote control to make cursor move in the small pane, green frame means the cursor has moved to this pane, press **【Enter】** to select or cancel motion detection of this small pane, when setup finished, press **【exit】** to back to MD setup interface, it will save automatically.

Remark:

IR Operation: press [Menu] key to select or cancel all the screen.

Mouse operation: click left and drag the frame to setup the region for motion detection.

2.2.2.5.4 MOBILE

Move the cursor to **【MOBLE】** (Icon highlighted when selected) , press **【Enter】** to enter into setting interface.

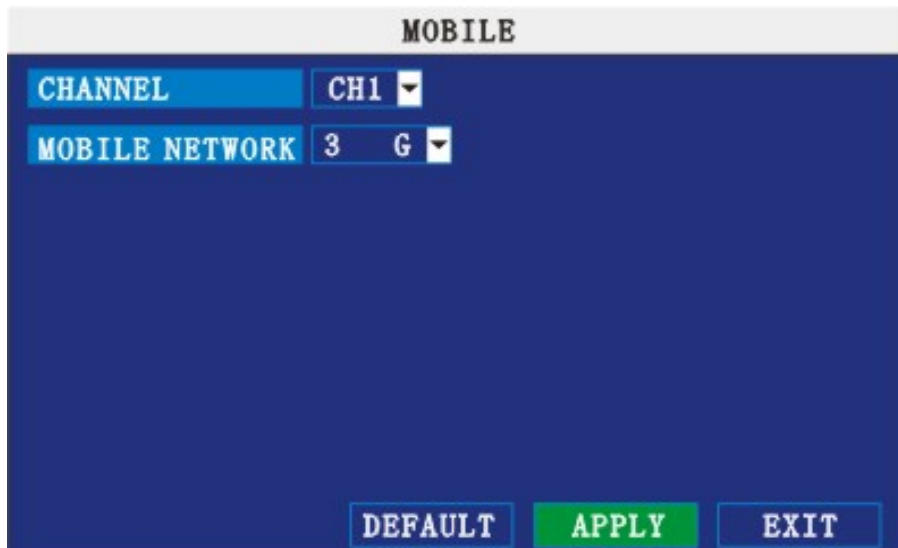

CHANNEL: select the channel for mobile view, and press [Enter] to switch different channels.

MOBLE NETWORK: Select different mobile network from the options of 3G, 2.5G and 2.75G, and press [Enter] to switch different network.

2.2.2.5.5 SYSTEM MAINTAIN

Move the cursor to **【SYSTEM MAINTAIN】** (Frame turns red means selected), and press **【Enter】** to enter into system maintain setup interface.

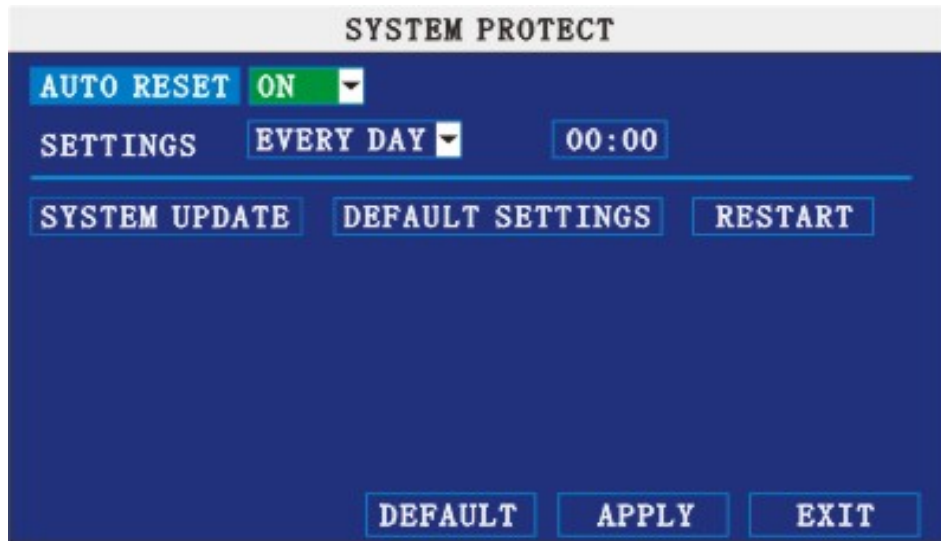

AUTO RESET: When switch is on, you can setup the time for device to restart.

SYSTEM UPDATE: Copy the update file to the root directory of the thumb driver, and insert it into USB 1.0, then press [Enter] to upgrade the firmware, and it will display the process of the system upgrading, as following:

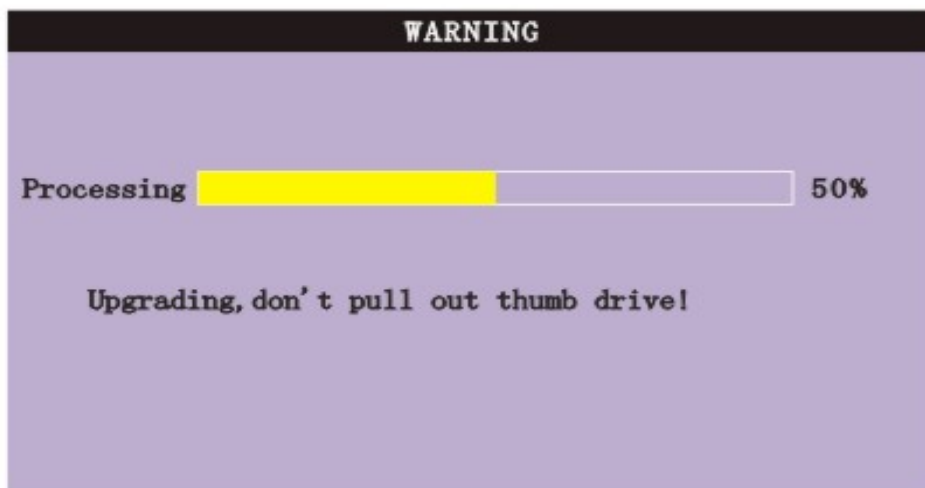

DEFAULT SETTINGS: Restore all the settings as the factory setting.

2.2.2.5.6 PTZ SETUP

Move the cursor to **【PTZ SETUP】** (Icon highlighted when selected), press **【Enter】** to enter into setting interface, you can setup the parameters for each channel separately.

CHANNEL: The channel of PTZ connected.

PROTOCOL: select the protocol of different PTZ, there are two protocols to switch, and the default is Pelco-D

BAUD RATE: select the different baud rate for your PTZ, there are 1200, 2400, 4800, and 9600
DATA BIT: there are 5,6,7,8 options to select, default setting is 8.
STOP BIT: there are 1 and 2 to select, the default setting is 1.
VERIFY: there are None/Odd/Even/Mark/Space to select, the default setting is none.
ADDRESS: Fill the code of respective PTZ

PTZ SETUP				
CHANNEL	CH1	CH2	CH3	CH4
PROTOCOL	Pelco-D	Pelco-D	Pelco-D	Pelco-D
BAUD RATE	9600	9600	9600	9600
DATA BIT	8	8	8	8
STOP BIT	1	1	1	1
VERIFY	ODD	ODD	ODD	ODD
ADDRESS	001	001	001	001
		DEFAULT	APPLY	EXIT

2.2.2.5.7 NETWORK SETUP

Move the cursor to [NETWORK SETUP] (icon thightlitend when selected), and press **【Enter】** to enter into setting interface .

TYPE: There are PPPOE, DHCP & Static three options.

- **STATIC**

Select [Static] in the type, and press [Enter] to enter into the interface as followings

NETWORK SETUP	
TYPE	STATIC
MEDIA PORT	09000
WEB PORT	00080
IP ADDRESS	192.168.015.141
NETMASK	255.255.255.000
GATEWAY	192.168.015.001
DNS	202.096.134.133
DDNS SETTINGS	
DEFAULT APPLY EXIT	

MEDIA PORT: transfers video data between client and device.

WEB PORT: setup the port of IE browser via HTTP.

IP ADDRESS: setup the IP address, and press [Enter], [+], [-] or number keys to change the value.

NETMASK: press [Enter], [+], [-] or number keys to change the value.

GATEWAY: press [Enter], [+], [-] or number keys to change the value.

- **DHCP**

Select the DHCP, and enter into the interface as followings.

The screenshot shows a terminal window titled "NETWORK SETUP" with a dark blue background and light blue text. The "TYPE" field is set to "DHCP" with a dropdown arrow. Below it, "MEDIA PORT" is set to "09000" and "WEB PORT" is set to "00080". Further down, the "DNS" field is set to "202.096.134.133". At the bottom, there is a "DDNS SETTINGS" button and three main action buttons: "DEFAULT", "APPLY" (highlighted in green), and "EXIT".

MEDIA PORT: transfers video data between client and device.

WEB PORT: setup the port of IE browser via HTTP.

PPPOE username and password: fill the username and password of the internet service offer, and apply it and reboot the system. After rebooting, the device will save it and set the PPPOE as default network type. If succeed, the IP address will be automatically config as dynamic IP of WAN.

- **PPPOE**

Select the PPPOE, and enter the interface as followings

The screenshot shows a terminal window titled "NETWORK SETUP" with a dark blue background and light blue text. The "TYPE" field is set to "PPPOE" with a dropdown arrow. Below it, "MEDIA PORT" is set to "09000" and "WEB PORT" is set to "00080". There are two empty input fields for "PPPOC NAME" and "PASSWORD". Further down, the "DNS" field is set to "202.096.134.133". At the bottom, there is a "DDNS SETTINGS" button and three main action buttons: "DEFAULT", "APPLY" (highlighted in green), and "EXIT".

MEDIA PORT: transfers video data between client and device.

WEB PORT: setup the port of IE browser via HTTP.

PPPOE username and password: fill the username and password of the internet service offer, and apply it and reboot the system. After rebooting, the device will save it and set the PPPOE as default network type. If succeed, the IP address will be automatically config as dynamic IP of WAN.

DNS: press [Enter], [+], [-] or number keys to change the value.

DDNS: move the cursor to it and press [Enter] to enter into the interface as followings.

DDNS SETUP	
DDNS	ON
SERVICE	3322
HOST NAME	
USERNAME	
PASSWORD	
[DEFAULT] [APPLY] [EXIT]	

DDNS: There are [ON/OFF], and if there is a DDNS service, please setup it as ON.

SERVICE: There are 3 services to select, 3322, dyndns, perfecteyes.

HOST NAME: Input the name of the host server.

USERNAME: Input in the name of the user.

PASSWORD: Input the password.

3 IE OPERATION

3.1 FEATURE

Through the IE browser of OS and install the software, you are able to do the network operation remotely, which is much more convenient. DVR support C/S, B/S, and visit in LAN and WAN, also support IP and domain name visiting.

3.2 USER LOGIN

Input the DVR local IP in IE browser, when changed the port, you should add the port number after IP address, e.g. if DVR local IP is 192.168.3.97 (LAN) and the port is 8088, you should input `http:// 192.168.3.97:8088`. The default port is 8088, and directly input `http:// 192.168.3.97` to access the login interface as following,

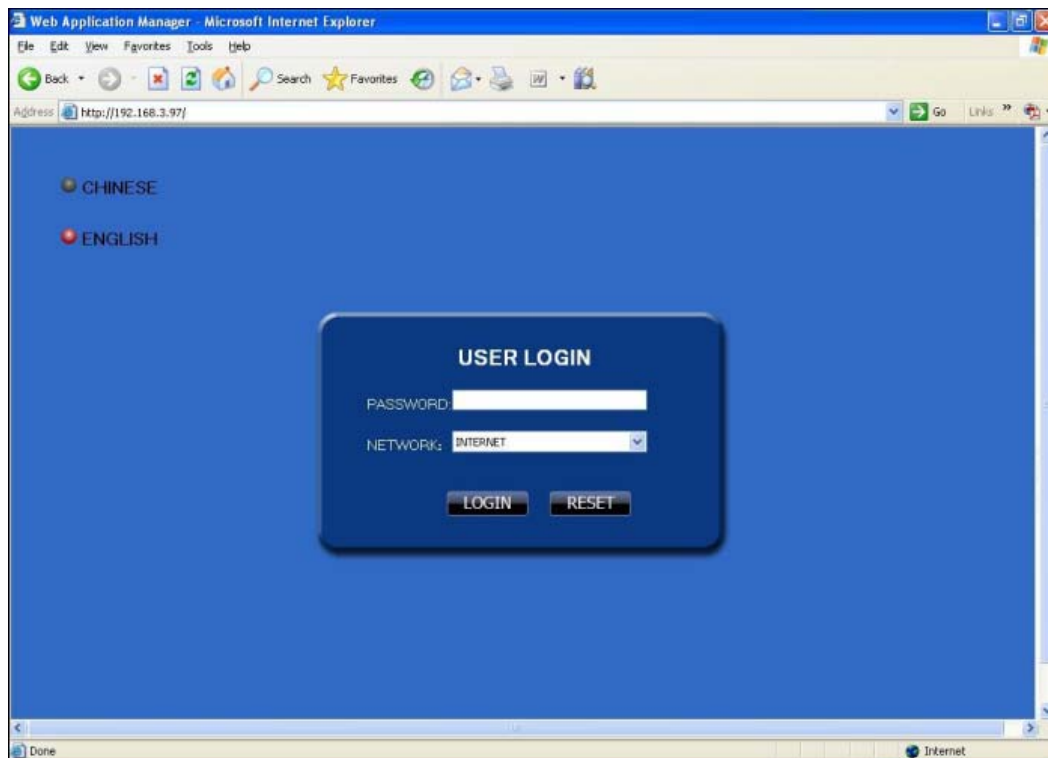

Select English interface in the top left side. Input username and password to enter into the system. The username and passport is same as the ones set in DVR.

PASSWORD: Administrator has all authorities, operator has limited authorities who they can only watch, playback, please change the unit No. and default password in time for system security.

NETWORK: LAN/WAN

Remark: If you connect the device in WAN, the IP should be a public IP.

3.3 OPERATION INTERFACE

There are Liveview, Playback and Setup options in the main interface, please press them to access it.

3.3.1 LIVE

Click  to enter into the interface as followings



3.3.1.1 PTZ CONTROL

Change the focus, preset aperture to control the PTZ.

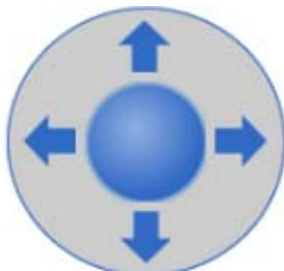

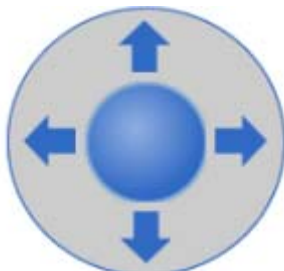
Click  to up/down/left/right control movement of the PTZ. When hold on the one direction key, the PTZ will keep circling as that direction after user press the stop key in the center of the wheel.

3.3.1.1.1 ZOOM



Click  ZOOM  to zoom in and out.

Click  FOCUS  to focus

Click  IRIS  to change the size of aperture

3.3.1.1.2 PTZ PRESET

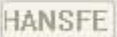
PAN&TILE POS: Setup preset point.

You can control it via the below three buttons:   

3.3.1.2 PLAY

Move cursor to the icons, it will highlighted when selected



Open all windows.



Capture picture, save in local disk, system save default route is C:/DVR



Quickly start all channels' recording video, here the left up corner of each channel have normal recording video symbol 【 R 】 , click icon to switch between singal

screen  /quad  /nine  /16 spllit .



Volumn adjust button

3.3.1.3 OTHER OPERATION

1. Select one channel at preview screen (the selected channel's frame will be change to RED), double click left key, enter to the selected channel single screen display.
2. Click one Chanel via left key at preview screen, then click right key, will occur window shortcut Menu, see below picture

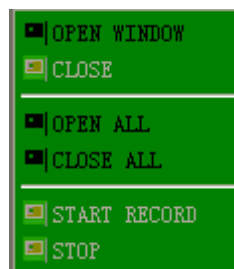

You can open, shut down and start this channel's record via shortcut menu.

3. Click right key at one live view screen, click "open all windows" or "close all windows", will

quickly open/close all windows.

3.3.2 REPLAY

Click  to enter into playback interface.



Click right up of calendar interface  and , to setup the month for searching, click "refresh", at the calendar interface will display the recording information of current month



The highlighted date means that day have recording video, RED FRAME means the date is system date, click the date will search that days' recording file list. For example, the above picture display 2008, Dec. 3rd, 4th, 5th, 6th, 8th, 9th, 10th, 11th, 12th, 17th, 18th have recording video, and system date is 18th, Dec, 2008, currently search date is 17th, Dec.

At the below of calendar select channel and type, click SEARCH, the result will display, as follow.

FILE LIST		
TIME	CHANNEL	SIZE
! 08:04:36-08:05:36	2	7.7M
! 08:04:36-08:05:36	3	7.7M
08:05:36-09:05:36	2	452.4M
08:05:36-09:05:36	3	455.6M
! 08:22:58-08:26:54	4	26.2M
08:26:54-09:18:59	4	357.6M
! 09:01:26-09:18:59	1	129.6M
09:05:36-09:18:59	2	101.4M
09:05:36-09:18:59	3	102.4M
! 09:19:39-09:26:52	1	53.1M
▶ 09:19:39-09:26:52	2	54.9M
09:19:39-09:26:52	3	54.9M
! 09:19:40-09:20:41	4	7.2M
09:20:41-09:26:52	4	43.1M
! 09:27:30-09:40:55	1	97.8M
09:27:30-09:40:55	2	101.4M
09:27:30-09:40:55	3	102.3M
09:27:30-09:40:55	4	92.3M

BACKUP REPLAY

Double click one item of listed recording video, the recording video will playback, meanwhile the file icon will change to ▶, and will occur the below picture play buttons:

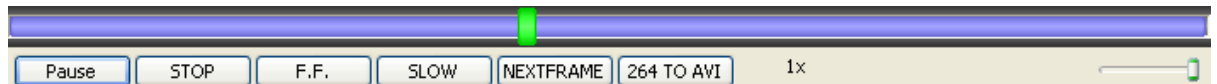

The above purple progress bar shows download progress, green progress bar shows playback progress

- Pause Switch between pause/play
- STOP Stop play
- F.F. Fast play
- SLOW Slow play
- NEXTFRAME Pause at next frame
- 264 TO AVI Convert H.264 file to H.avi file, click this button access into file convert setting interface, as follow.

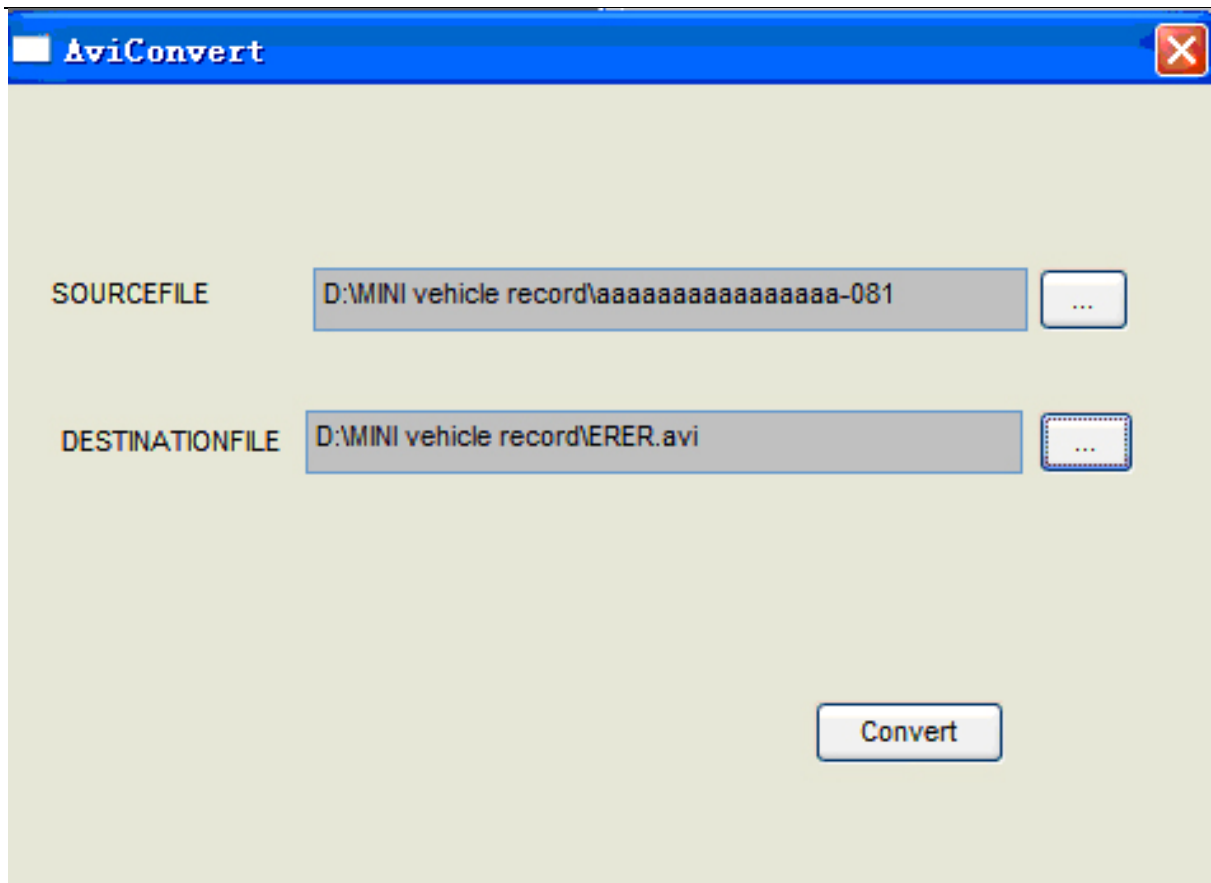

SOURCE FILE: Click  to setup the H.264 file to convert

DESTINATION FILE: Click  to setup the directory for saving avi file

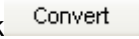
After setting, click , file convert start, the convert progress bar (see below picture) will see the progress of convert.

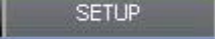

3.3.3 SETUP

Click  to enter into setup interface, this interface include record, alarm, PTZ, network, setting and system information six menus.

3.3.3.1 RECORD

Click  to enter into setup interface; you can check the parameter settings as in GUI of DVR.

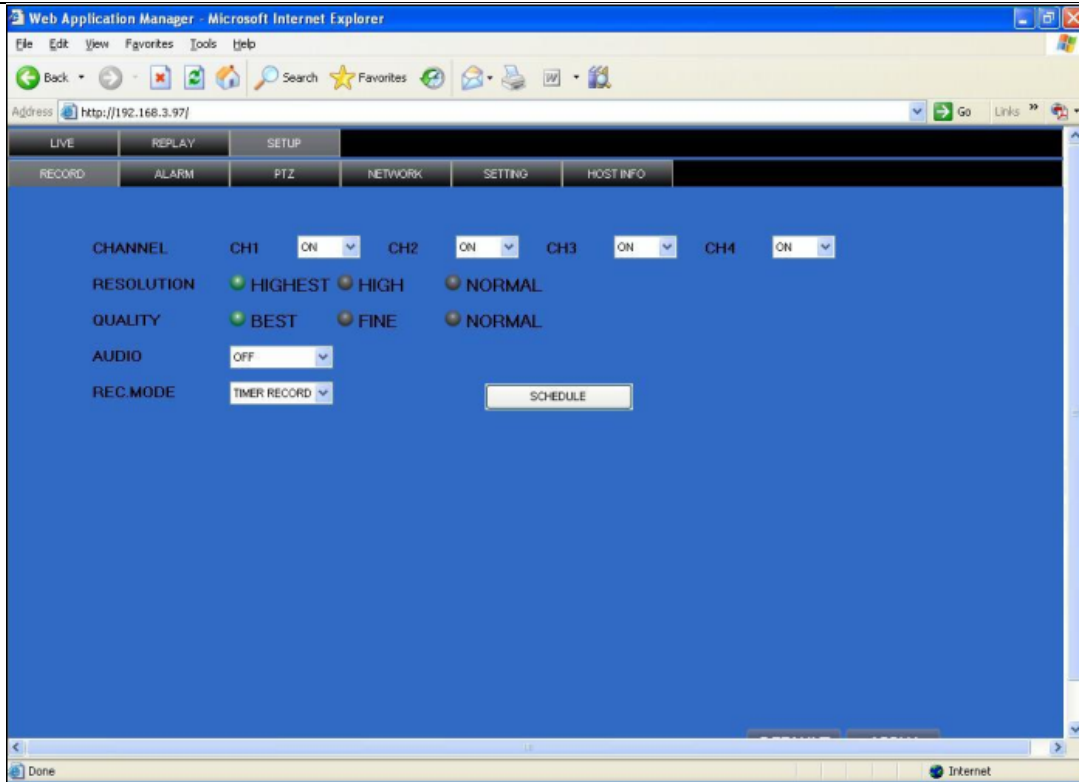

3.3.3.2 ALARM

Click  to enter into setup interface; you can check the parameter settings as in GUI of DVR.

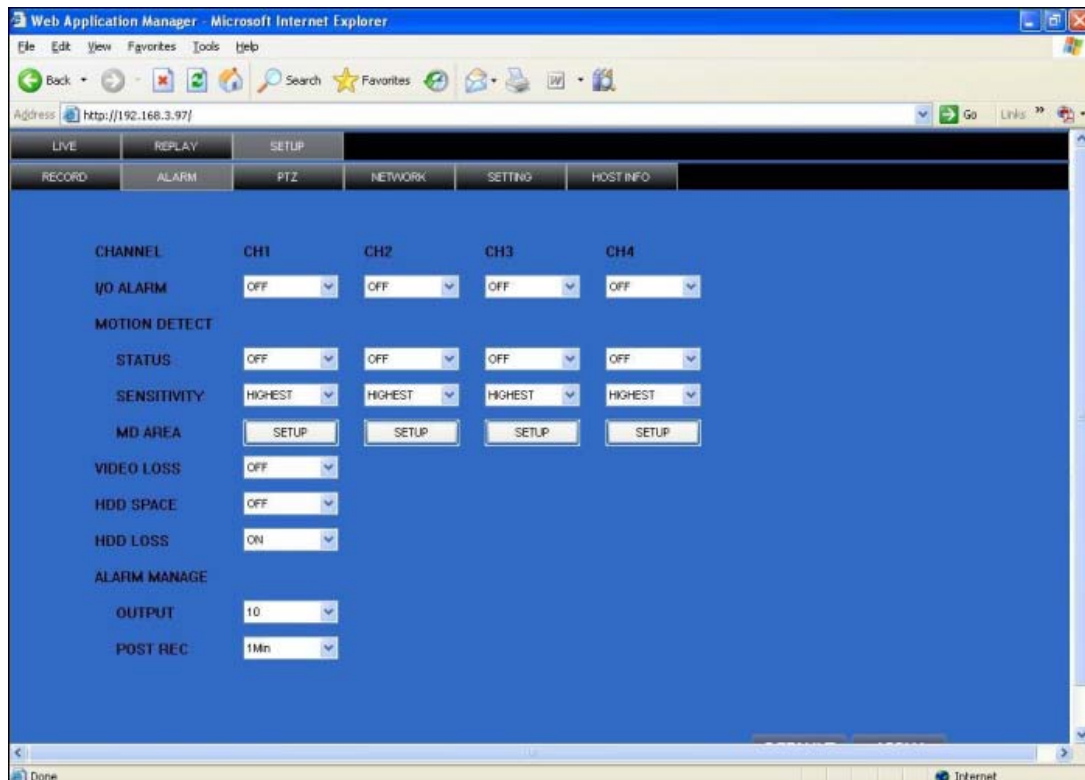

3.3.3.3 PTZ

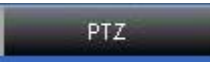
Click  to enter into setup interface; you can check the parameter settings as in GUI of DVR.

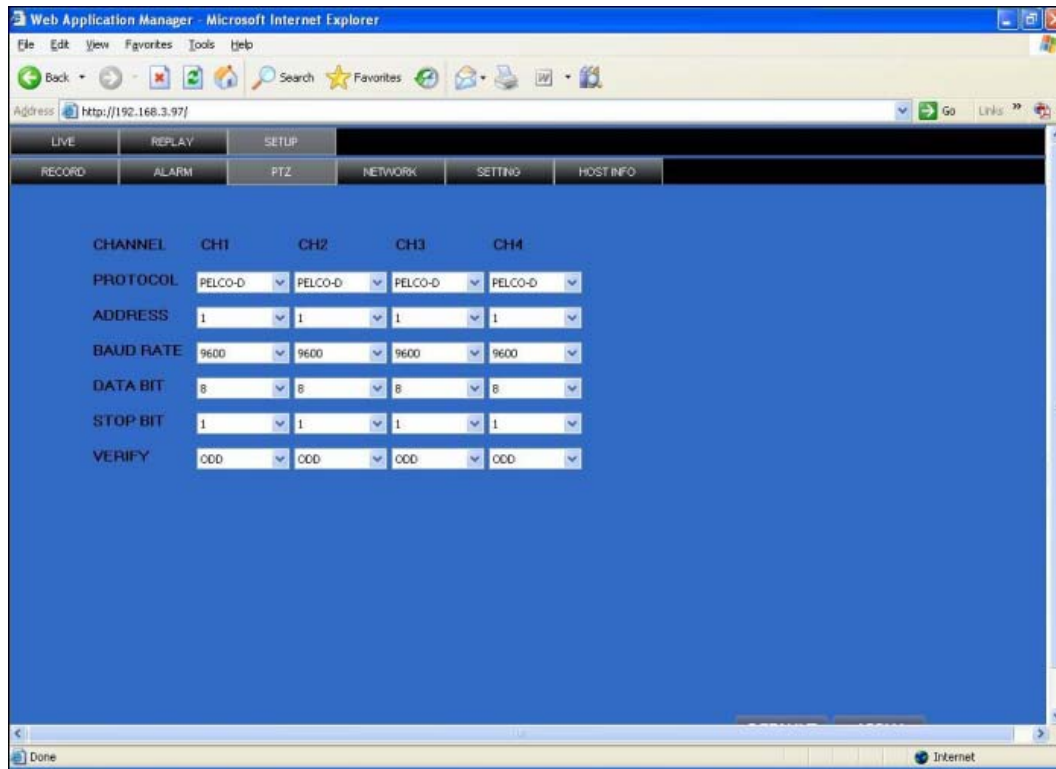

3.3.3.4 NETWORK

Click  to enter into setup interface; you can check the parameter settings as in GUI of DVR.

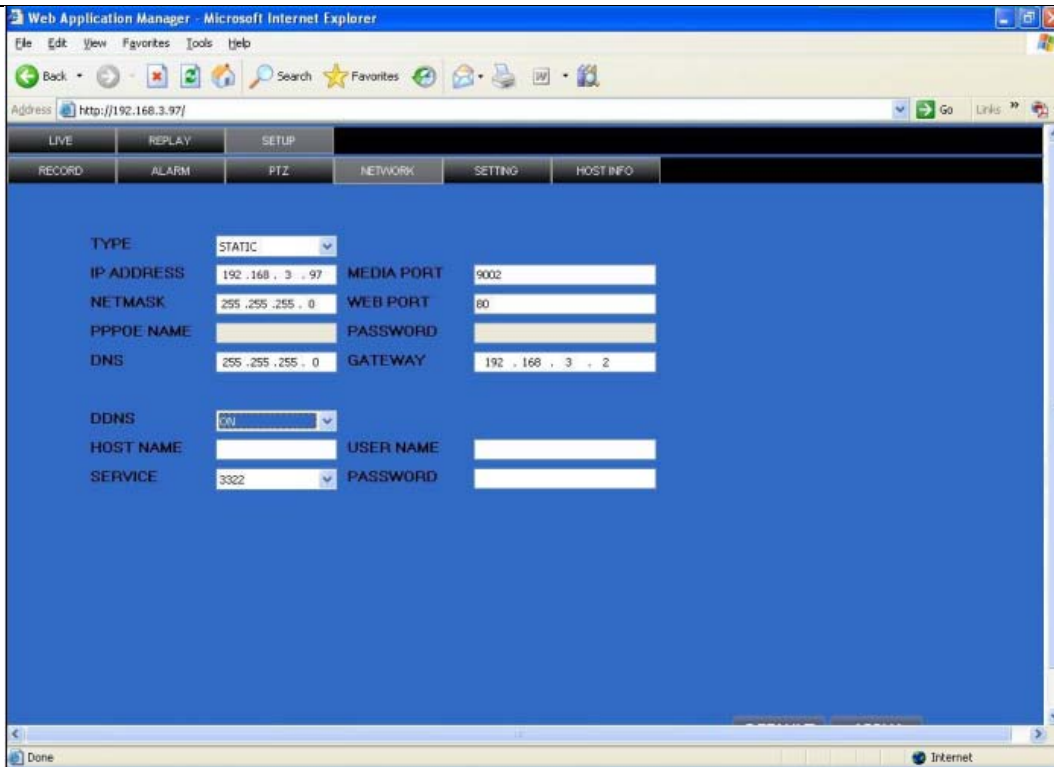

3.3.3.5 SETTING

Click  to enter into setup interface; you can check the parameter settings as in GUI of DVR.

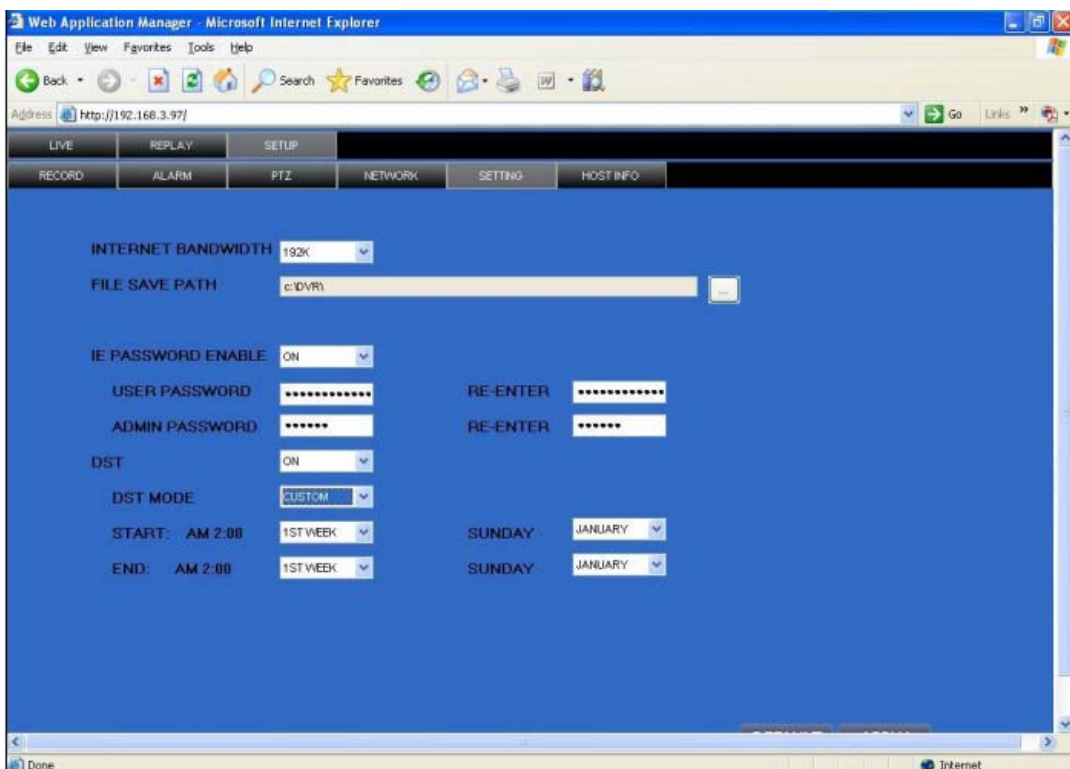

BANDWIDTH: Set the amount of bandwidth in kbps (128k、192k、256k、384k、512k、1024k) that you want to allocate for traffic that matches internet, this bandwidth not include audio .

FILE SAVE PATH: capture picture and recording video save path.

IE login password and DST settings you can check as DVR setting.

3.3.3.6 HOST INFO

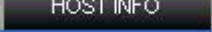
Click  to enter into system information interface (see below picture), this interface shows HDD status, remain record time, firmware version, MAC Address, and all the information is fixed.

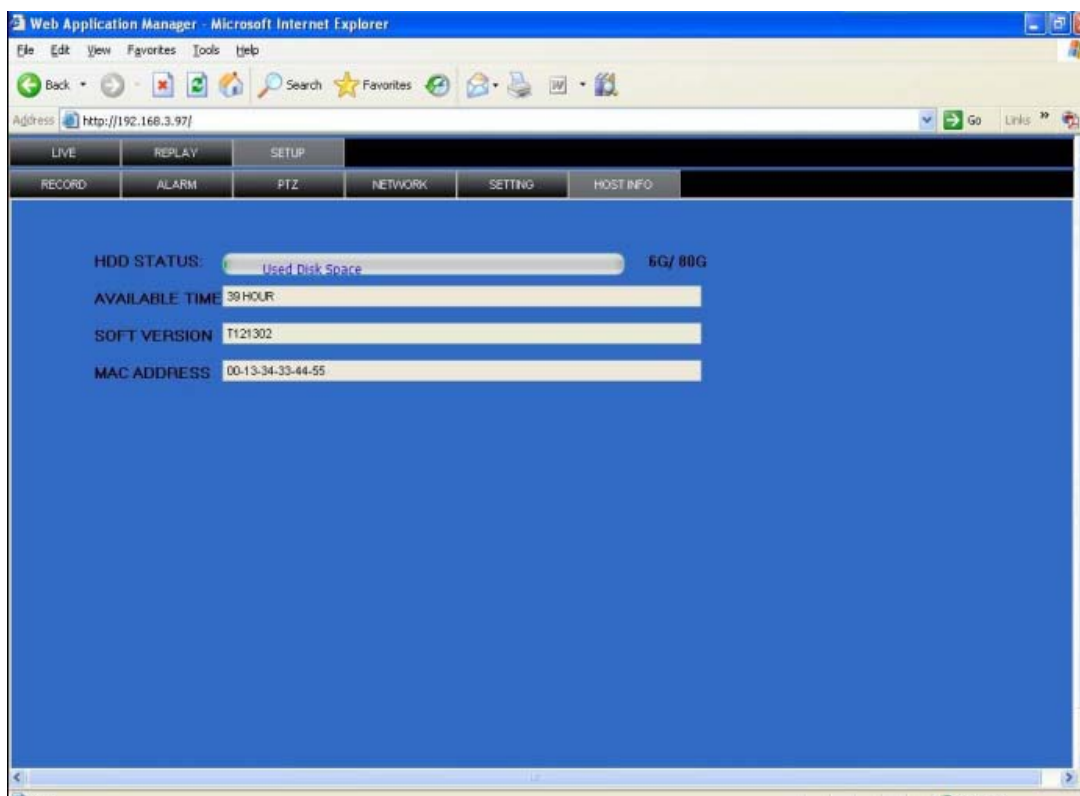

4 DVR Installation Guideline

4.1 Product Overview



1. Product Photo



2. The Definition of Bottoms and Connectors on Front Panel

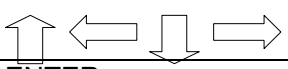

Buttons on Front Panel

#	Button	Name	Description
1	Power	STANDBY	POWER/OFF, boot up DVR or shutdown DVR
2	Control Keys	Navigation 	During the setting for GUI, use these buttons for choosing different items on menu. And also control the direction of PTZ.
		ENTER	Confirm
		SETUP	Enter into the setup menu
			For vision to be Single image or QUAD
3	Status LED	REC	recording
		ALM	Alarming
		ERR	Error indicator
		FULL	LED flashing means HDD is full
		HDD	HDD status
		100M	ON means 100M network transmission
		LINK	ON means network connection is OK
	POW	POWER	
Receiver	IR	Receiver for remote control signal	
4	USB	USB2.0	for download and upload data
5	USB	USB1.1	for mouse connect

3. The definition of buttons and connectors on rear panel

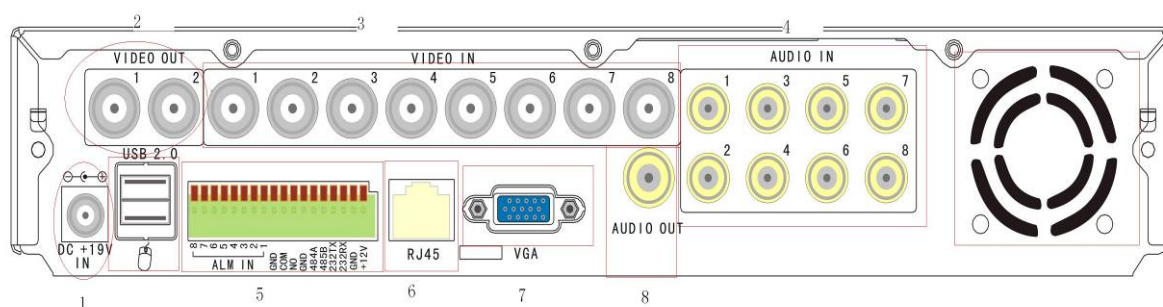

Connectors on Rear Panel

Item	Physical connector	Connector description
1	POWER input	DC 19V/3A
2	Video output	Two video output for connecting TV or monitor (BNC)
3	Video input	For connecting analog video signal input (BNC)
4	Audio Input	For connecting audio signal
5	Alarm Input	I/O alarm input, 4 for 4CH DVR and 8 for 8CH DVR
	Alarm Output	I/O output for alarm
	RS485	RS 485 for connecting PTZ
	RS232	For connecting PC
	+12V	Power supply for DC relay and the current is 100MA (make sure short circuit can not happen)
6	Network	For connecting Ethernet
7	VGA VGA	For connecting VGA monitor
8	Audio Output	For connection audio output
9	Fan	Please check the fan function for diary maintenance and change new one if the fan has some problems

4. Connectors for Alarm

Peel off the color skin of the cable and then insert the cable into the slot on the rear panel DVR (The connection part for alarm).

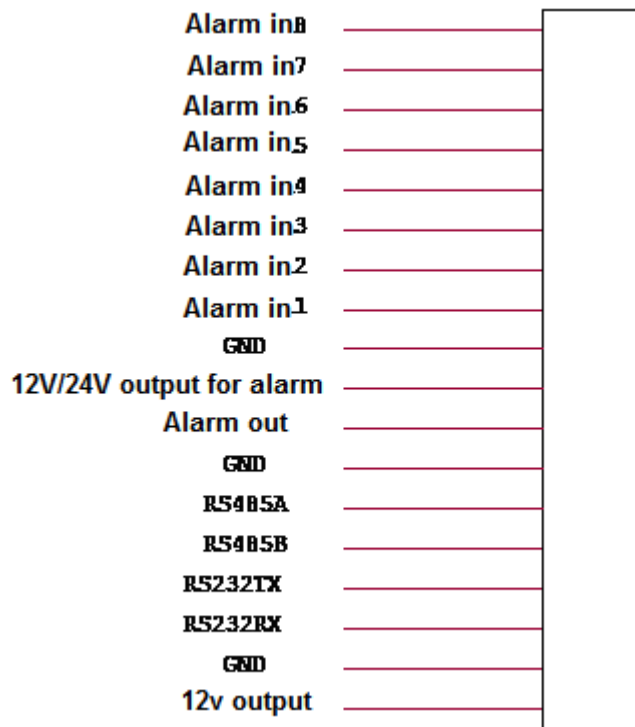

5. Alarm Input and Output

There are 8 sets alarm input connector and 1 set output for this DVR. Alarm input is for connection IR annunciator, fog sensor. The connection diagram of DC alarm inout as following:

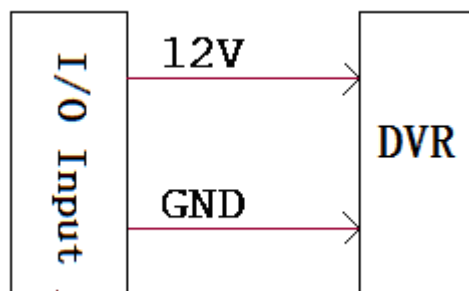

Connection diagram of AC alarm input as following:

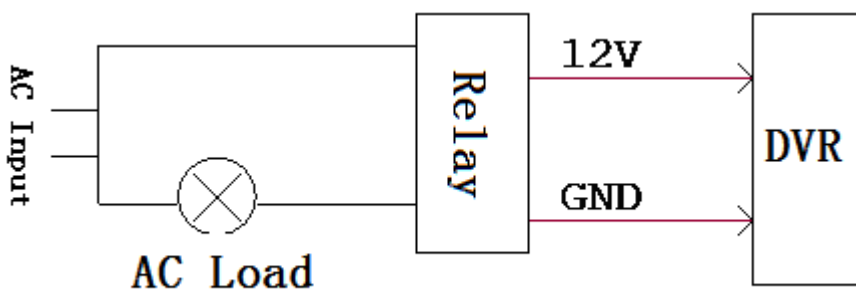

The connection diagram of alarm output as following:

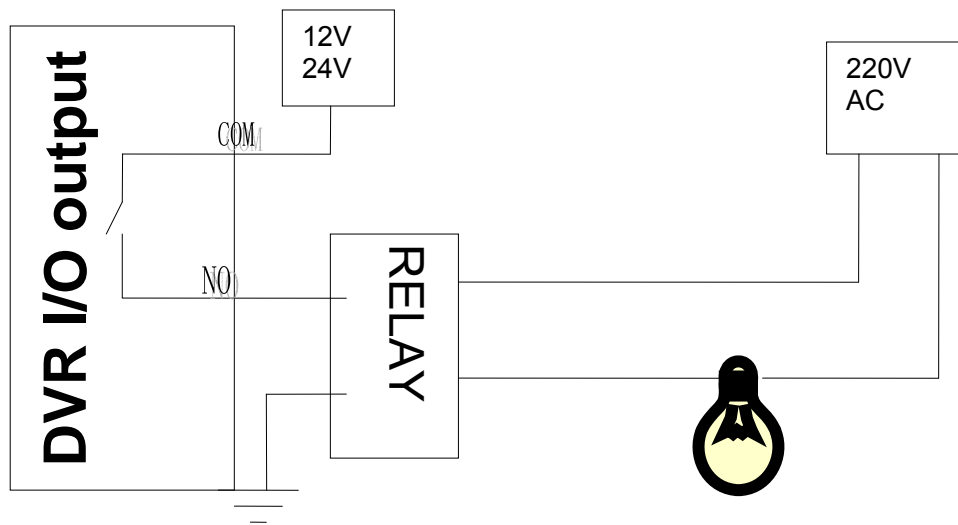

6. System Network Diagram

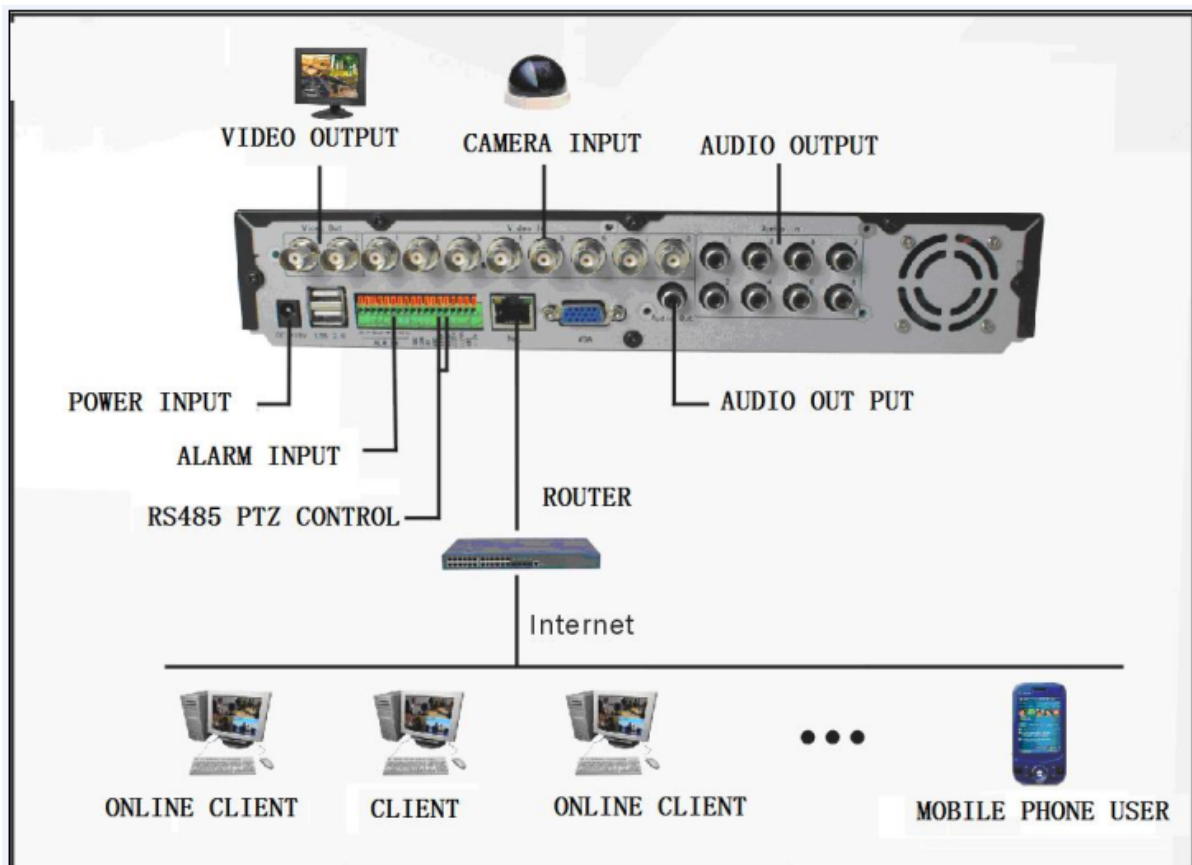

4.2 HDD Installation

Please installation the HDD as the following steps:

- 1) Uninstall the DVR and then you will see one HDD plate as following.



- 2) Take out the anti-vibration mat and screws from the accessories box



- 3) Take off the HDD plate and then install the anti-vibration mat on the plate and then screw on it.



4) Install the HDD on HDD plate as the following photo indicate and then screws around.



5) Fix the HDD plate on the DVR device and then cover the DVR and screw.



Remark: Please format the new HDD before record.