



ENGLISH



GB *Use and maintenance manual*

General Index

1. FOREWORD	3
1.1 GENERAL	3
1.2 PURPOSE OF THE MANUAL	3
1.3 WHERE AND HOW TO KEEP THE MANUAL	3
1.4 MANUAL UPGRADES	3
1.5 COLLABORATION WITH USERS	4
1.6 MANUFACTURER	4
1.7 MANUFACTURER'S RESPONSIBILITY AND WARRANTY	4
1.7.1 <i>Terms of warranty</i>	4
1.8 TECHNICAL ASSISTANCE SERVICE	5
1.9 COPYRIGHT	5
2. TECHNOLOGICAL DESCRIPTION	6
2.1 PURPOSE	6
2.2 TECHNICAL SPECIFICATIONS	6
2.3 DIMENSIONS AND WEIGHTS	6
3. STARTING	7
4. CONTROL PANEL	8
5. USE OF THE WHEEL BALANCER	9
5.1 DIMENSIONS SETTING WHEEL	9
5.1.1 <i>Standard wheel</i>	9
5.1.2 <i>Wheels with internal correction to rim</i>	9
5.2 MEASUREMENT RESULT	9
5.3 SPLIT FUNCTION (UNBALANCE RESOLUTION)	10
5.4 UNBALANCE OPTIMISATION	10
6. SETUP	11
6.1 MENU	11
6.1.1 <i>Self-diagnostics</i>	12
6.1.2 <i>Calibration</i>	12
7. DIAGNOSTICS	13
7.1 INCONSISTENT UNBALANCE READINGS	13
7.2 ALARM SIGNAL	13
8. MAINTENANCE	15
8.1 GENERAL	15
8.1.1 <i>Introductory notes</i>	15
8.1.2 <i>Safety rules</i>	15
8.1.3 <i>Replacing fuses</i>	15
9. DISPOSAL	16
9.1 DISPOSING OF THE BALANCER	16
9.2 DISPOSING OF ELECTRONICS COMPONENTS	16

10. SPARE PARTS	16
10.1 IDENTIFICATION AND ORDERING METHOD	16
11. ATTACHED DOCUMENTATION	16

1. Foreword



WARNING

THIS MANUAL IS AN INTEGRAL PART OF THE INSTALLATION MANUAL WHICH SHOULD BE CONSULTED CONCERNING STARTING AND USING THE MACHINE SAFELY.
READ CAREFULLY BEFORE CONTINUING.

1.1 GENERAL

The machine has been constructed in conformity with the current EC Directives and the technical standards implementing the requirements, as stated in the declaration of conformity issued by the manufacturer and attached to the manual.

This publication, hereinafter simply referred to as '**manual**', contains all the information required to safely use and service the machine referred to in the Declaration of Conformity.

This appliance, hereinafter is generically referred to as '**machine**'.

The manual addresses operators instructed on the precautions to take in relation to the presence of electric current and moving devices.

This publication is intended for all 'users' who as far as within their competence need to and/or are obliged to give instructions to others or operate on the machine themselves.

These persons can be identified as follows:

- operators directly involved in transporting, storing, installing, using and servicing the machine from when it is put on the market until when it is scrapped;
- direct private users.

The original Italian text of this publication constitutes the only reference to resolve any interpretation controversies related to the translation into the European Community languages.

This publication forms an integral part of the machine and must therefore be kept for future reference until final dismantling and scrapping of the machine.

1.2 PURPOSE OF THE MANUAL

This manual, and the installation manual, contains the instructions required to use the machine safely and carry out routine maintenance work.

Any calibrations, adjustments and extraordinary maintenance operations are not considered in this document as they may only be performed by the service engineer who must work on the machine according to the technical and rated characteristics for which it was built.

Though it is fundamental to read this manual, it cannot replace skilled technical staff who must be adequately trained beforehand.

The foreseen use and configurations of the machine are the only ones allowed by the manufacturer; do not attempt to use the machine in a different way.

Any other use or configuration must be agreed in advance with the manufacturer in writing and in this case an annex will be attached to this manual.

For use, the user must also comply with the specific workplace legislation in force in the country where the machine is installed.

The manual also refers to laws, directives, etc., that the user must know and consult in order to accomplish the goals that the manual sets out to achieve.

1.3 WHERE AND HOW TO KEEP THE MANUAL

This manual (and relative attachments) must be kept in a safe and dry place and must always be available for consultation.

Make a copy and keep it in the archive.

When exchanging information with the manufacturer or the technical assistance staff authorised by the former, quote the rating plate information and the serial number of the machine.

This manual must be kept for the entire lifetime of the machine, and if necessary (e.g.: damage making all or some of it illegible, etc.) the user must request another copy exclusively from the manufacturer, quoting the publication code indicated on the cover.

1.4 MANUAL UPGRADES

This manual is an integral part of the machine and reflects the state of the art at the moment it was put on the market. The publication complies with the directives in force on that date; the manual cannot be considered inadequate as a result of regulatory updates or modifications to the

machine.

Any manual upgrades that the manufacturer may see fit to send to users will become an integral part of the manual and must be kept together with it.

1.5 COLLABORATION WITH USERS

The manufacturer will be pleased to provide its customers with any further information they may require and will consider proposals for improving this manual in order to more fully satisfy the requirements it was written for.

In case of transfer of ownership of the machine, which must always be accompanied by the use and maintenance manual, the original user must inform the manufacturer of the name and address of the new user in order to allow it to send the new user any communications and/or updates deemed to be indispensable.

This publication is the property of the Manufacturer and may not be fully or partly reproduced without prior written agreement.

1.6 MANUFACTURER

The machine identification data is indicated on the plate mounted on the machine.

The plate below is shown for the sake of example.

MODEL	<input type="text"/>	VER	<input type="text"/>
SER. N°	<input type="text"/>		
<input checked="" type="checkbox"/> V	<input type="text"/>	CE	KW <input type="text"/>
<input type="checkbox"/> A	<input type="text"/>		Hz <input type="text"/>
PHASE	<input type="text" value="1"/>	° [C]	<input type="text"/>
AIR SUPPLY Kg/cm ²		<input type="text"/>	

1.7 MANUFACTURER'S RESPONSIBILITY AND WARRANTY

In order to make use of the manufacturer's warranty, the user must scrupulously observe the precautions contained in the manual, in particular he must:

- never exceed the limits of use of the machine;
- always constantly and carefully clean and service the machine;
- have the machine used by people of proven capacity and attitude, adequately trained for the purpose.

The manufacturer declines all direct and indirect liability caused by:

- use of the machine in a different way from that indicated

in this manual

- use of the machine by people who have not read and fully understood the contents of this manual;
- use in breach of specific regulations in force in the country of installation;
- modifications made to the machine, software and operating logic, unless authorised by the manufacturer in writing;
- unauthorised repairs;
- exceptional events.

Transfer of the machine to a third party must also include this manual; failure to include the manual automatically invalidates all the rights of the purchaser, including the terms of warranty, where applicable.

If the machine is transferred to a third party in a country with a different language from the one written in this manual, the original user shall provide a faithful translation of this manual in the language of country in which the machine will operate.

1.7.1 Terms of warranty

The Manufacturer guarantees the machines it manufactures against all manufacturing or assembly faults for 12 (twelve) months from the date of collection or delivery.

The Manufacturer undertakes to replace or repair any part which it deems to be faulty free of charge at its factory, carriage paid.

If a Manufacturer's repairman (or a person authorised by the same) is required to work at the user's facilities, the relative travel expenses and board and lodging shall be charged to the user.

The free supply of parts under warranty is always subject to the faulty part being inspected by the manufacturer (or a person authorised by the same).

The warranty is not extended following repairs or other work done to the machine.

The warranty does not cover damage to the machine deriving from:

- transport;
- neglect;
- improper use and/or use not in compliance with the instructions in the operating manual
- incorrect electrical connections.

The warranty is invalidated in case of:

- repairs made by people who were not authorised by the manufacturer;
- modifications that were not authorised by the manufacturer;
- use of parts and/or equipment that were not supplied or approved by the manufacturer;
- removal or alteration of the machine identification plate.

1.8 TECHNICAL ASSISTANCE SERVICE

For any technical service operation, contact the manufacturer directly or an authorised dealer always quoting the model, the version and the serial number of the machine.

1.9 COPYRIGHT

The information contained in this manual may not be disclosed to third parties. Partial or total duplication, unless authorised by the Manufacturer in writing, through photocopying, duplication or other systems, including electronic acquisition, is breach of copyright and can lead to prosecution.

2. Technological description

2.1 PURPOSE

It is used to balance the wheels of cars, vans, 4-WD, motorcycles and scooters weighing less than 75 Kg. It can be operated in the temperature range of 0° to + 45°C.

The machine can operate only on flat non resilient floor. To lift the machine, lever only on the base where the 3 support points are located. never, under any circumstance, apply force to other points such as the spindle, head, or accessory shelf. It functions properly without having to fasten it to the floor with wheels weighing up to 35 kg; for heavier wheels, fasten it at the points indicated. Do not mount anything other than motorbike, car or truck tyres on the wheel balancer.

Thanks to the new and exclusive VDD (Virtual Direct Drive) system, reliable unbalance measurements can be made in a short time, almost half the time of the cycle used with respect to other balancers in this range.

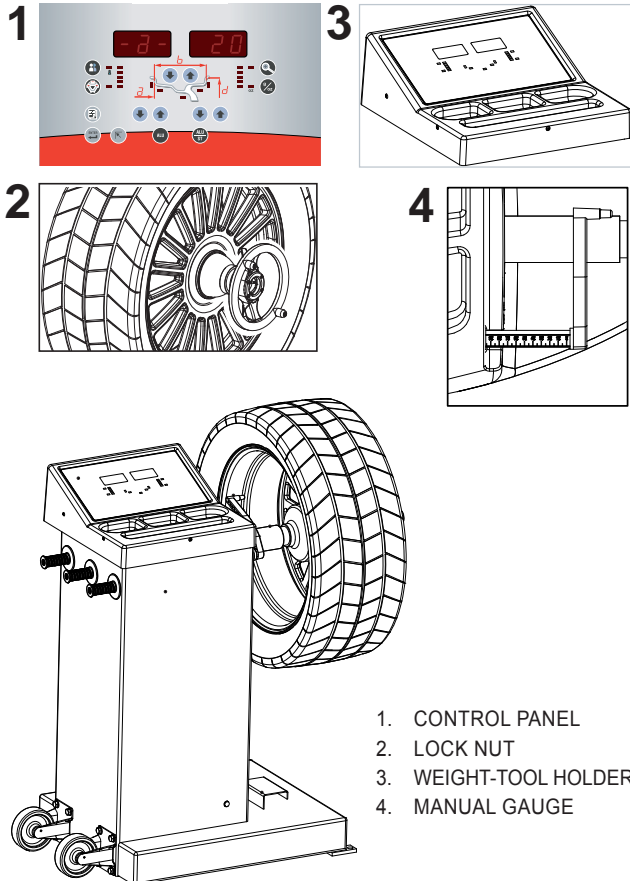

1. CONTROL PANEL
2. LOCK NUT
3. WEIGHT-TOOL HOLDER
4. MANUAL GAUGE

The main features include:

- direct selection of the metrical or Anglo-Saxon system
- machine settings menu.
- optimisation of tyre and rim unbalance.
- static programme, ALU / ALU "S" / SPLIT.
- automatic minimisation of static unbalance.

2.2 TECHNICAL SPECIFICATIONS

The following data refers to the balancer in its standard configuration.

Single phase power supply	115 or 230 V 50-60 Hz (see rating plate)
Protection class	IP 54
Cycle time per wheel	4.7 seconds (5 3/4"x14") 15 Kg.
Balancing speed	100 min ⁻¹
Balancing accuracy	1 gram
Position resolution	± 1.4 °
Average noise	< 70 dB(A)
Rim width settable	1.5" ÷ 20" or 40 ÷ 510 mm
Settable diameter	10" ÷ 30" or 265 ÷ 765 mm

2.3 DIMENSIONS AND WEIGHTS

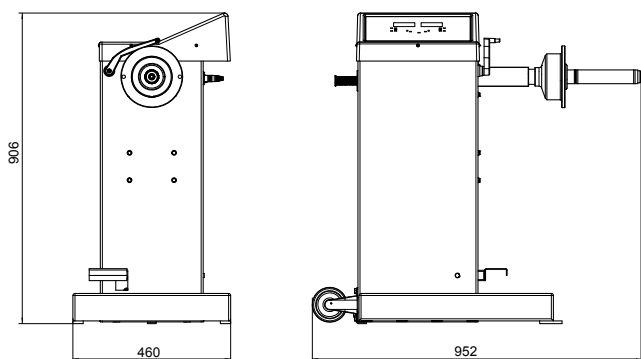

The machine complete with flange weighs 110 kg.

3. Starting



WARNING

BEFORE SWITCHING ON THE MACHINE, MAKE SURE THAT ALL THE CONNECTIONS DESCRIBED IN THE **INSTALLATION** CHAPTER HAVE BEEN MADE CORRECTLY.

THE FOLLOWING OPERATIONS INVOLVE A POTENTIAL RISK FOR THE OPERATOR, GIVEN THE PRESENCE OF VOLTAGE ON THE EQUIPMENT. THE **PERSONAL PROTECTIVE EQUIPMENT** DESCRIBED IN THE **INSTALLATION** MANUAL MUST BE WORN AND WORK MUST BE DONE WITH DUE CARE AND ATTENTION.

OPERATIONS MAY ONLY BE PERFORMED BY A SPECIALISED TECHNICIAN.

Before powering the machine, carry out the following checks:

1. check that the balancing machine touches the floor at the three support points;

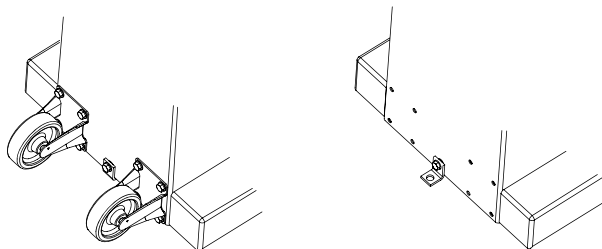
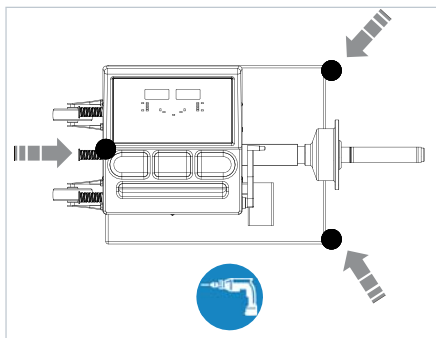

2. make sure that all the parts of the balancer are correctly connected and fixed;
3. make sure that the parameters (voltage and frequency) of the mains power supply are compatible with those indicated on the rating plate of the balancer;
4. make sure the power cable is correctly connected;
5. make sure the machine shaft and flange hole are clean.



CAUTION

ANY TRACES OF DIRT MAY AFFECT BALANCING ACCURACY.

6. To switch on the balancer press the switch on the left-hand side of the machine.

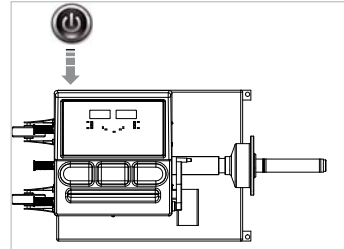

7. Position the wheel on the terminal with the inner part facing the balancer;

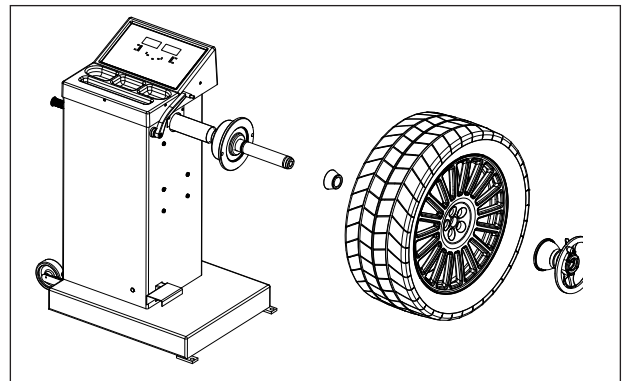

8. At this point, you can read the tyre measurements and perform balancing.

4. Control panel

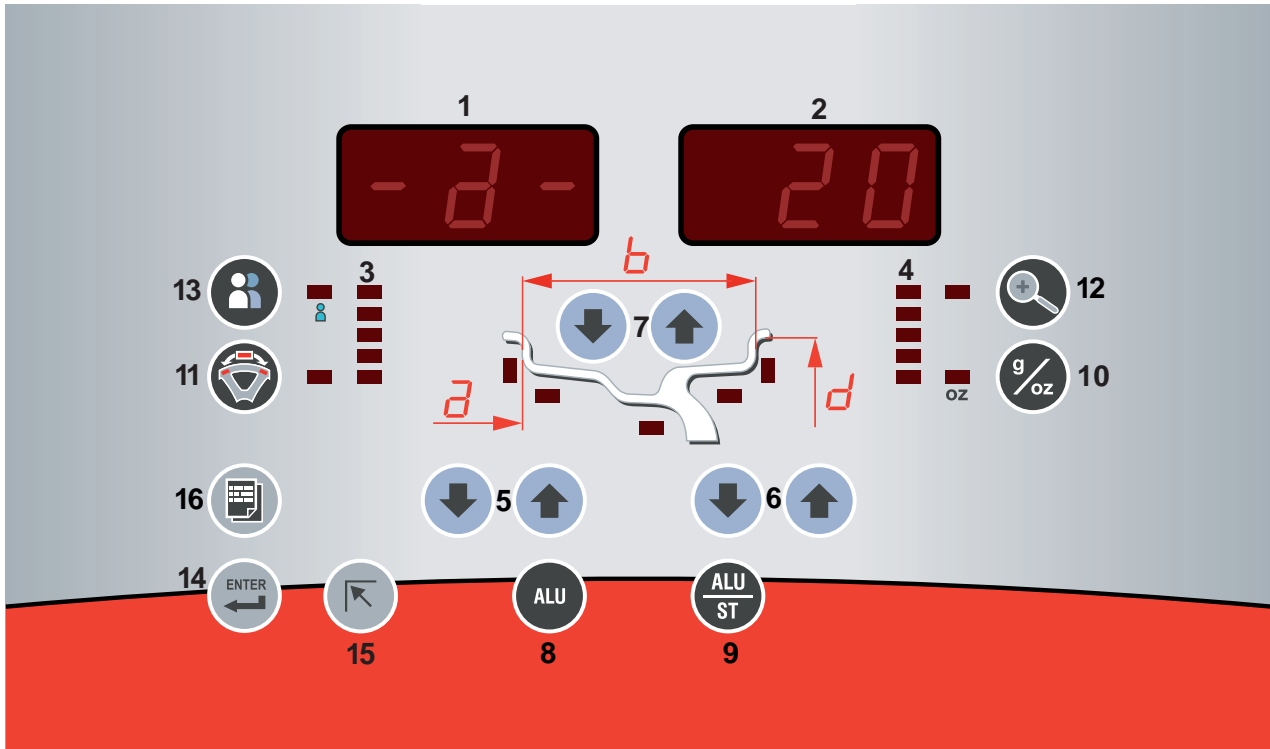

1. Inner side UNBALANCE VALUE digital indicator
2. Outer side UNBALANCE VALUE digital indicator
3. Inner side UNBALANCE POSITION indicator
4. Outer side UNBALANCE POSITION indicator
5. DISTANCE setting
6. DIAMETER setting
7. WIDTH setting
8. INNER SIDE correction position selection (selects and views the position for applying the correction weight)
9. STATIC and OUTER SIDE correction position selection (selects and views the position for applying the correction weight)
10. Grams/ounces selection
11. SPLIT (unbalance resolution)
12. Unbalance reading < 5 g (.25 oz)
13. Push button, operator selection
14. Confirm MENU selection
15. HOME
16. FUNCTIONS menu



CAUTION

PRESS THE BUTTONS WITH YOUR FINGERS.
NEVER USE THE COUNTERWEIGHT GRIPPERS OR OTHER POINTED OBJECTS!

5. Use of the wheel balancer

5.1 DIMENSIONS SETTING WHEEL

5.1.1 Standard wheel

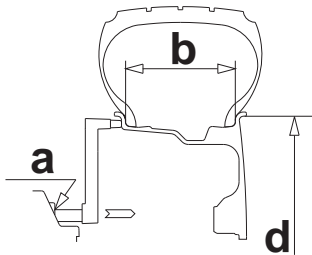

- a. Set the DISTANCE "a" between the inner side of the wheel and the machine. Use the relative gauge on the machine to measure this.

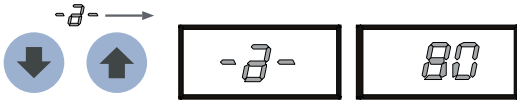
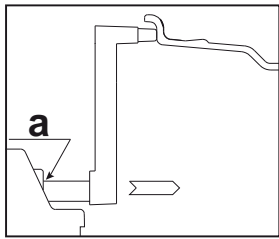

- b. Set the rated WIDTH, normally indicated on the rim, or measure the width "b" using the supplied calliper gauge.

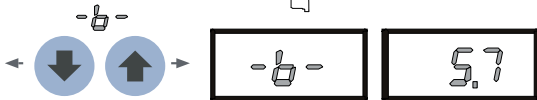
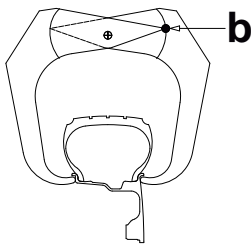

- c. Set the rated DIAMETER "d" indicated on the tyre.

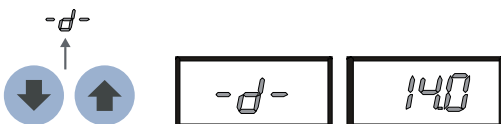

5.1.2 Wheels with internal correction to rim

Select the correction position according to the method used to apply the weights to the wheels.

For this operation use the two buttons **ALU** **ST**. Use the gauge to measure the distances according to the following scheme.

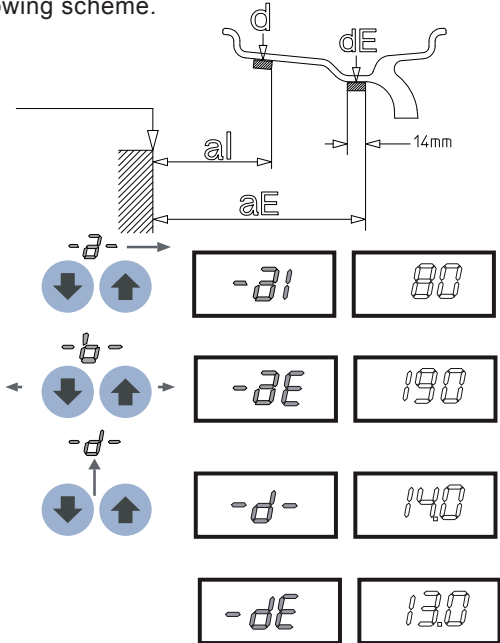

To set **dE** hold down the button **ALU/ST** (red button) for 2 seconds, when any of the dimensions appear on the display.

5.2 MEASUREMENT RESULT

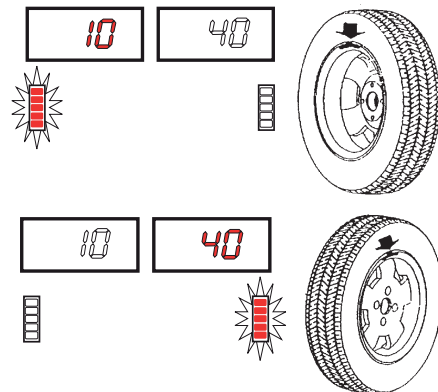

Move the wheel manually until all the LED's corresponding to the side light up. The display shows the measured unbalance.

For unbalance within tolerance **0 (zero)**; using  values within tolerance can be viewed.

5.3 SPLIT FUNCTION (unbalance resolution)

The SPLIT function is used to position the adhesive weights behind the wheel spokes (angle > 18°) so that they are no longer visible (for alloy rims). Use this function in the ALU or STATIC mode where the adhesive weight is applied inside the rim.

Enter the wheel dimensions in the ALU S mode and press START.

- a. Turn the wheel to the outer side unbalance correction position.

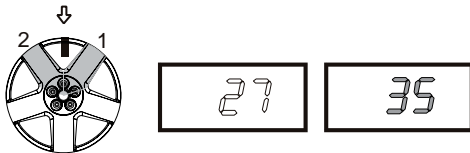

- b. Move one of the spokes to 12 o'clock (e.g.: 1) and press .

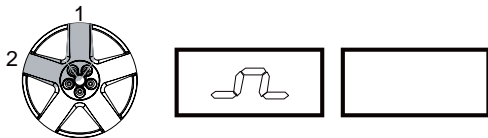

- c. Following the direction of rotation indicated by the position LED's, move spoke 2 to 12 o'clock and press . The value to use for correction in position 2 is displayed.

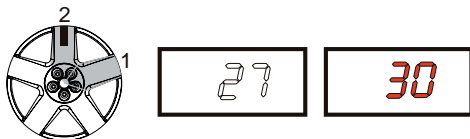

- d. Move spoke 1 to the correction position as indicated by the position LED's

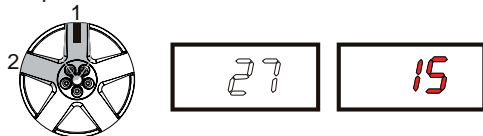

To return to the normal unbalance indication press any button.

INFORMATION

The spoke-to-spoke distance must be a minimum of 18° and a maximum of 120° (if not, errors 24, 25 or 26 appear). Spokes with irregular or inconstant angles can be compensated.

5.4 UNBALANCE OPTIMISATION

This operation is performed to reduce the static unbalance of the wheel. It is suitable for static unbalance values in excess of 30 grams.

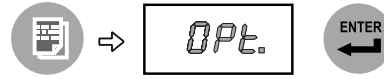

- a. If no unbalance was measured before, START appears on the display. Press this button to proceed.

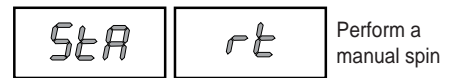

- b. Make a reference mark on the flange and the rim (using a piece of chalk, for example). With the aid of a tyre remover, turn the tyre on the rim by 180°. Refit the wheel in such a way that the reference marks on the rim and the flange coincide.

Press START to begin reading.

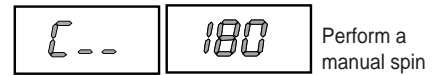

- c. RH display: percentage reduction value
LH display: actual static unbalance value which can be reduced by rotation



- d. Mark the two positions of the rim and tyre, and turn the tyre on the rim until the positions coincide to achieve the optimisation shown on the display

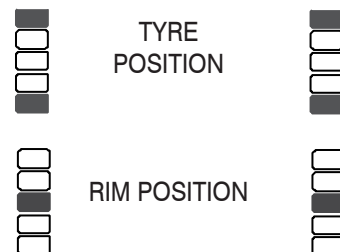

To cancel optimisation at any time, press .

6. Setup

6.1 MENU

This is used to personalise some balancer functions and to perform calibrations.
To access this section, press the FUNCTIONS MENU button.

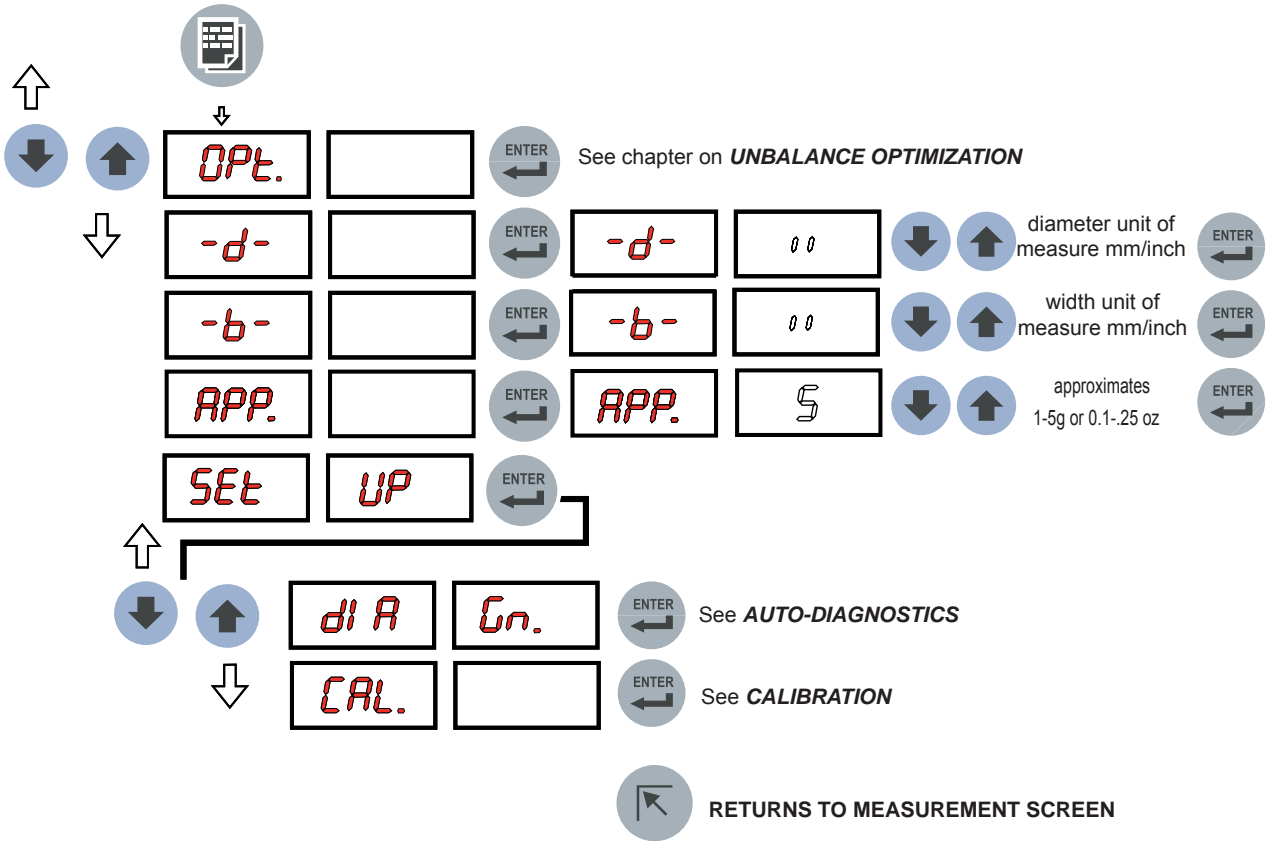

6.1.1 Self-diagnostics

The machine can perform self-diagnostics to check the LED's on the control panel and make sure the encoder reads correctly.

To perform this operation, view the SETUP menu.

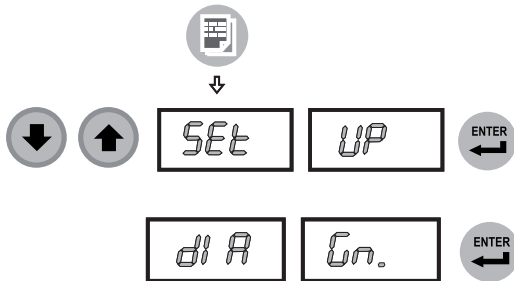

In the self-diagnostics sequence, all the LED's on the panel light up for a few seconds in order to check operation. When the LED's go out, the machine automatically moves on to the encoder reading phase. When the wheel is turned manually (forwards and backwards), the display shows its exact position. The value lies between 0 (zero) and 255.

6.1.2 Calibration

To calibrate the machine, proceed as follows:

- Fit an average size wheel with a metal rim on the shaft. Example: 6" x 15" (± 1").
- Set the wheel measurements as described in paragraph **SETTING WHEEL DIMENSIONS**.



CAUTION

SETTING INCORRECT DIMENSIONS WOULD MEAN THAT THE MACHINE IS NOT CORRECTLY CALIBRATED, THEREFORE, ALL SUBSEQUENT MEASUREMENTS WILL BE INCORRECT UNTIL CALIBRATION IS PERFORMED ONCE AGAIN WITH THE CORRECT DIMENSIONS.

Display the SETUP menu:

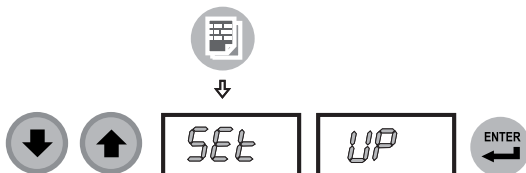

- Press or to view view the CALIBRATION function.

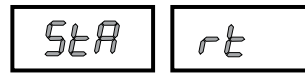

Perform a manual spin

- Add a standard weight of 60 g (2.00 oz) to the outer side, in any position.

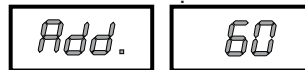

Perform a manual spin

- Shift the standard weight from the outside to the inside keeping the same position.



Perform a manual spin

- Turn the wheel until the standard weight is at the top (12 o'clock).



- End of calibration.



To cancel calibration at any time, press .

7. Diagnostics

7.1 INCONSISTENT UNBALANCE READINGS

In some cases, when a wheel that has just been balanced is repositioned on the balancer, the machine can detect an unbalance.

This is not a machine problem but is due to faulty mounting of the wheel on the flange. In other words, when mounting the wheel after initial balancing, it has taken another position with respect to the balancer shaft axis.

If the wheel has been mounted on the flange with screws, the screws may not have been tightened correctly (criss-cross sequence) or the tolerances of the holes drilled in the wheel may be too large. Small errors, up to 10 grams (4 oz), are to be considered normal in wheels locked with the relative cone: The error is normally greater for wheels locked with screws or studs.

If, after balancing, the wheel is still unbalanced when re-fitted on the vehicle, this could be due to an unbalanced brake drum or, very often, the tolerances of the holes drilled in the rim and drum are too large. In this case, balancing should be performed using a balancer with the wheel mounted on the vehicle.

7.2 ALARM SIGNAL

The machine has a self-diagnostics cycle which identifies the most frequent malfunctions during the normal work cycle.

These malfunctions are processed by the system and shown on the display.



**WARNING**

THE INFORMATION IN THE **POSSIBLE REMEDY** COLUMN REQUIRES WORK TO BE PERFORMED BY SPECIALIST TECHNICIANS OR OTHER AUTHORISED PEOPLE WHO MUST ALWAYS WORK USING THE **PERSONAL PROTECTIVE EQUIPMENT** INDICATED IN THE **INSTALLATION** MANUAL. IN SOME CASES, THIS WORK CAN BE PERFORMED BY A NORMAL OPERATOR.

ERROR	CAUSE	POSSIBLE REMEDY
Black	The wheel balancer does not switch on.	<ol style="list-style-type: none"> 1. Check the machine is properly connected to the mains power supply. 2. Check the fuses on the power board and replace if necessary. 3. Replace the CPU board.
Err. 1	No rotation signal.	<ol style="list-style-type: none"> 1. Use the self-diagnostics function to check the encoder. 2. Replace the encoder. 3. Replace the CPU board.
Err. 2	Speed too low during detection. During the unbalance measurement revolutions, the wheel speed has fallen to below 42 rpm.	<ol style="list-style-type: none"> 1. Make sure that a vehicle wheel is mounted on the wheel balancer. 2. Use the self-diagnostics function to check the encoder. 3. Detach the measuring head connector from the board and do a spin (if no error is detected, replace the measuring heads). 4. Replace the CPU board.
Err. 3	Unbalance too high.	<ol style="list-style-type: none"> 1. Check the wheel dimensions setting. 2. Check the detection unit connections. 3. Mount a wheel with more or less known unbalance (less than 100 grams) and check the response of the machine. 4. Replace the CPU board.
Err. 4	Rotation in opposite direction.	<ol style="list-style-type: none"> 1. Use the self-diagnostics function to check the encoder. 2. Check the encoder bearing/spring.
Err. 7 Err. 8 Err. 9	NOVRAM parameter read error	<ol style="list-style-type: none"> 1. Switch off the machine and wait for at least ~ 1 min; re-start the machine and check it works properly. 2. Repeat machine calibration. 3. Replace the CPU board.
Err. 14 Err. 15 Err. 16 Err. 17 Err. 18 Err. 19	Unbalance measurement error.	<ol style="list-style-type: none"> 1. Use the self-diagnostics function to check the encoder. 2. Check the detection unit connections. 3. Check the machine earthing connection. 4. Mount a wheel with more or less known unbalance (less than 100 grams) and check the response of the machine. 5. Replace the CPU board.
Err. 20	Wheel still. The wheel must remain still for more than one second after START.	<ol style="list-style-type: none"> 1. Use the self-diagnostics function to check the encoder. 2. Check the connections on the power board. 3. Replace the CPU board.
Err. 22	Maximum number of spins possible for the unbalance measurement has been exceeded.	<ol style="list-style-type: none"> 1. Check that a vehicle wheel has been mounted on the wheel balancer. 2. Use the self-diagnostics function to check the encoder 3. Replace the computer board.
Err. 23	The wheel does not slow down	<ol style="list-style-type: none"> 1. Remember to release the spinning device when the displays go off 2. Use the self-diagnostics function to check the encoder 3. Replace the computer board.
Err. 24	Distance between the spokes less than 18 degrees.	<ol style="list-style-type: none"> 1. The minimum distance between the spokes where the unbalance is to be split must be greater than 18 degrees. 2. Repeat the SPLIT function increasing the distance between the spokes.
Err. 25	Distance between the spokes greater than 120 degrees.	<ol style="list-style-type: none"> 1. The maximum distance between the spokes where the unbalance is to be split must be less than 120 degrees. 2. Repeat the split function increasing the distance between the spokes.
Err. 26	First spoke too far from the unbalance	<ol style="list-style-type: none"> 1. The maximum distance between the unbalance position and the spoke must be less than 120 degrees. 2. Repeat the split function increasing the distance between the spokes and the unbalance.

8. Maintenance

8.1 GENERAL



CAUTION

BEFORE PERFORMING ANY MAINTENANCE OPERATIONS, MAKE SURE THE MACHINE HAS BEEN DISCONNECTED FROM THE MAINS POWER SUPPLY. ALWAYS USE THE PERSONAL PROTECTIVE EQUIPMENT INDICATED IN THE INSTALLATION MANUAL.

8.1.1 Introductory notes

This machine has been designed so as not to require routine maintenance, apart from accurate periodic cleaning. It is important to keep the machine perfectly clean in order to prevent dust or impurities from compromising the operation of the balancer.



WARNING

THE PEOPLE RESPONSIBLE FOR CLEANING THE AREA WHERE THE MACHINE IS INSTALLED MUST WEAR PERSONAL PROTECTIVE EQUIPMENT IN ORDER TO WORK IN SAFETY AND ACCORDING TO THE CURRENT OCCUPATIONAL HEALTH AND SAFETY REGULATIONS.

As extraordinary maintenance must be performed by service staff or, in any case, by specifically authorised and trained people, is not dealt with in this manual.

8.1.2 Safety rules

Performing specialist activities on the equipment, particularly if the guards need to be dismantled, exposes people to serious danger due to the presence of potentially live parts.

The rules shown below must be scrupulously followed.

People must always use the Personal Protective Equipment indicated in the Installation Manual. During activities, unauthorised people may not access the equipment and WORK IN PROGRESS signs will be erected in the department in such a way that they are visible from every place of access.

Specialist staff must be authorised and especially trained concerning the dangers that may arise during operation and the correct methods for avoiding them. They must always work with great care and pay full attention.

If, exceptionally, the staff removes the guards to carry out a particular specialist technical maintenance, inspection or repair job, they are required to put them back after work.

After work, staff must make sure that foreign objects, in particular mechanical pieces, tools or devices used during the operative procedure that could cause damage or malfunctions are not left inside the balancer.

For safety, before starting work, maintenance, inspection and repair staff must disconnect all power sources and take all the necessary preventive safety measures.

As well as operating frequencies, the operations described below indicate the qualifications that staff must possess in order to perform the operation.

8.1.3 Replacing fuses

Some protection fuses are located on the power board (see wiring diagrams) accessible by dismantling the weight shelf). If fuses require replacement, use ones with an identical current intensity.

9. Disposal



CAUTION

THE INSTRUCTIONS IN THIS CHAPTER ARE INDICATIVE. REFER TO THE REGULATIONS IN FORCE IN THE COUNTRY WHERE THE EQUIPMENT IS USED.

9.1 DISPOSING OF THE BALANCER

The balancer must be disposed of after dismantling the various parts.

For disposal operations, as well as wearing the Personal Protective Equipment indicated in the INSTALLATION MANUAL, refer to the instructions and diagrams in this manual. If necessary, request specific information from the manufacturer.

Once you have removed the various parts and components, separate them into the different types of materials according to the differentiated waste disposal regulations in force in the country where the machine is dismantled.

If the various components must be stored before being taken to the dump, make sure to keep them in a safe place protected from atmospheric agents in order to prevent them from contaminating the ground and the water table.

9.2 DISPOSING OF ELECTRONICS COMPONENTS



Community directive 2002/96/EC, assimilated in Italy with legislative decree n° 151 of 25th July 2005, requires electrical and electronic equipment manufacturers and users to comply with a number of obligations concerning the collection, treatment, recovery and disposal of this waste.

Please scrupulously comply with these waste disposal regulations. Remember that abusive dumping of this waste leads to the application of the administrative penalties established by current law.

10. Spare parts

10.1 IDENTIFICATION AND ORDERING METHOD

The various parts can be identified using the exploded drawings, the electrical drawings and diagrams in the machine technical file which is archived by the Manufacturer to which a request can be made.

For off-the-shelf parts, the technical manuals or the supplier's original documents can be provided if the Manufacturer deems this to be useful.

If not supplied, this documentation is also included in the machine Technical File, archived by the Manufacturer, as regards by Ministerial Decree 98/37/EC. In this case, contact the Technical Service to identify the required piece.

If the required pieces are not in any position or they cannot be identified, contact the Technical Service, specifying the type of machine, its serial number and year of construction.

This information is indicated on the machine identification plate.

11. Attached documentation

If not supplied, this documentation is included in the Technical File of the machine, archived by the Manufacturer.

In this case, contact the Technical Service for detailed information concerning the machine.