

DJI DROPSAFE

User Manual V1.0

2014.12

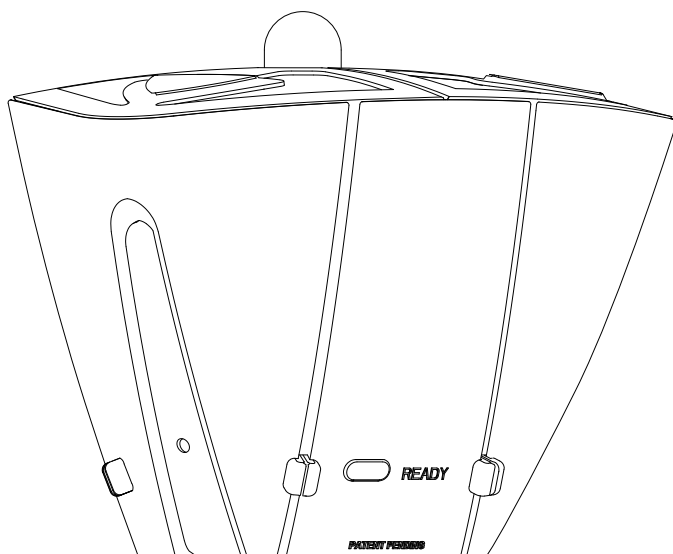

Contents

Disclaimer	3
Using this manual	3
Legend	3
Watch the Tutorial Videos	3
Profile	3
In the Box	3
System Introduction	5
System Base	5
Installing DJI Dropsafe System	6
Detach System Base	6
Attachment Pad	6
Configure Remote Controller Switches	6
System Base Connection	6
Setting Up the System Base for Deployment	7
Setting Up the CO ₂ Canister	9
Folding the Parachute	10
Connecting DJI Dropsafe to Your Multirotor	10
Install Backup Battery	12
DJI Dropsafe System Activation	12
Appendix	13
Specifications	13
System LED table	13

Disclaimer

The DJI Dropsafe is designed to reduce the drop speed of your flight platform. There is no guarantee that it will protect your equipment, prevent injury, or prevent property damage.

CO₂ canisters are required and not included with the DJI Dropsafe. DJI assumes no liability for or damages or injuries incurred directly or indirectly from using CO₂ canisters improperly or using CO₂ canisters that don't meet safety requirements or standards.

Using this manual

Legend

 Important

 Hints and Tips

Watch the Tutorial Videos

Please watch the tutorial videos below to learn how to use DJI Dropsafe correctly and safely.

www.dji.com/product/dropsafe/video

DJI Dropsafe official tutorial videos



Profile

The DJI Dropsafe is designed to reduce the drop speed of your flight platform. It is mounted to your flight platform and can be remotely activated when properly setup. In the event of an emergency, it deploys in less than half a second, and is effective at a minimum altitude of 6 meters. The DJI Dropsafe is compatible with DJI S1000+, S1000, S900 systems and DJI A2 flight control system.

CO₂ canisters are required and not included with the DJI Dropsafe. Only use ISI 16g CO₂ canisters or other 16g CO₂ canisters with specifications as shown in the figure. Improper use of the 16g CO₂ canisters, or using other CO₂ canisters, may cause system error or damage.

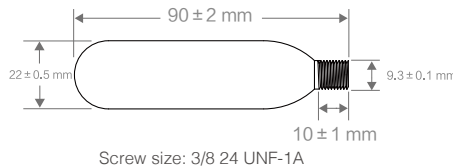

In the Box

The complete DJI Dropsafe package includes the following items. If any items are missing, contact DJI or your local DJI authorized dealer for assistance.

Parachute Housing x1

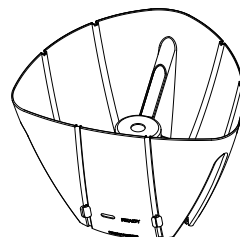

Winglet x3



Side Strip x3

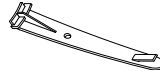

System Base x1
(Including: spring and triggering pin)

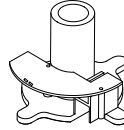

Manifold x1

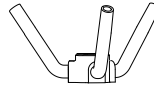

Packing Tool x1

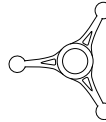

Connection Cable x4

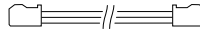

Safety Pin x1



Trigger Compression Tool x1



Hex Screwdriver x1



Attachment Pad x2

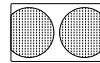

Parachute Pack x1

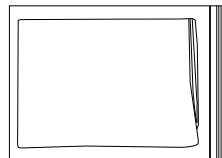

Screw x1



Backup Battery x1

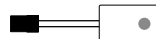

System Introduction

System base serves as the major component for the DJI Dropsafe system. Features such as self-check, stopping motors, triggering CO₂ canister are implemented by the system base and flight controller. Triggering safety pin is in place to prevent users from accidentally triggering the system. Parachute can be deployed in less than 0.5 second.

System Base

Top View

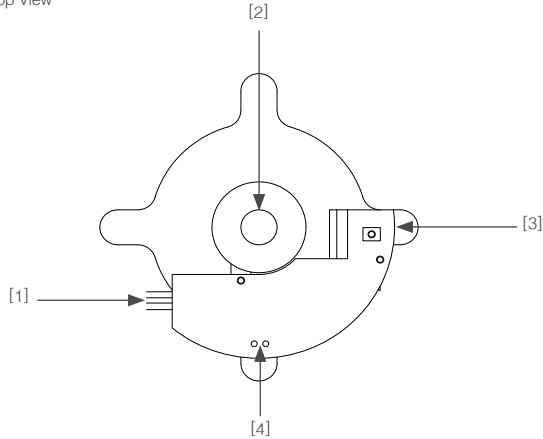

- [1] Connection Ports
- [2] Triggering Housing Unit

- [3] Initialization Button
- [4] System LEDs

Connection Ports

Used to connect the DJI Dropsafe to a DJI flight controller and remote controller receiver.

Triggering Housing Unit

Houses the spring and triggering pin.

Initialization Button

Press the initialization button to put the system into the ready state.

System LEDs

The system LEDs indicate the system status. Refer to the table in the Appendix for LED definitions ([P13](#)).

Installing DJI Dropsafe System

Detach System Base

System base is attached to parachute housing by default. To set up the system base, you need to detach the system base from the parachute housing. Follow the steps below to detach the system base from the parachute housing:

1. Remove the cover, then take off the winglets and side strips.
2. Remove the screw and take off parachute housing.
3. Unscrew the manifold.

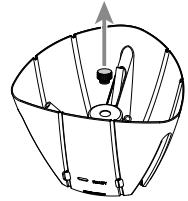

Attachment Pad

Stick one of the attachment pads onto the bottom of the DJI Dropsafe system base, and the other pad to the center of your aircraft's upper plate. Then secure the system base to your aircraft by pressing the attachment pad on the system base against the attachment pad on the aircraft.



Caution: The system base must be placed in the center of the aircraft's upper plate to achieve optimal performance.

Configure Remote Controller Switches

Two remote controller switches must be configured for proper use of the DJI Dropsafe: one is a "safety switch", and the other is an "activation switch" used to activate and deploy the system. Follow the instructions below. For the details on how to configure the channel assignment of the switches, refer to your remote controller's user manual.

1. Recommend to select a trainer switch to act as the "safety switch".
2. Select a 2-position switch to act as the "activation switch".

System Base Connection

Remote Controller and Flight Controller Connection

The DJI Dropsafe system base must be connected to your flight controller and RC receiver to function properly. Refer to the diagram below to complete the connections:

For A2 flight control system, connect the ECO and WK ports on the system base to the X3 and F4 ports on your flight controller. Then, connect the RC2 port on the system base to the port on the RC receiver that will be used as an "activation switch" to activate and deploy the DJI Dropsafe. Lastly, connect the RC1 port on the system base to the port on the RC receiver that will be used as a "safety switch".

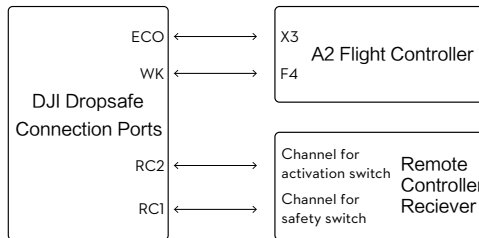

The DJI Dropsafe system can be deployed by A2 flight control system automatically. Upgrade the A2 controller unit firmware to 2.4 version or above and enable the parachute function in A2 Assistant to use the DJI Dropsafe system with A2 flight control system.

Setting Up the System Base for Deployment

Ensure the "activation switch" and "safety switch" on your remote controller are turned off. Ensure the spring and triggering pin are within the triggering housing unit. Follow the instructions below to set up the system base:

1. ① Place the trigger compression tool into the triggering housing unit. ② Use the supplied hex screwdriver to rotate the trigger compression tool clockwise for five times and then power on the on-board battery. The LED indicators on system base will blink red and green for three times to indicate the system is functional.

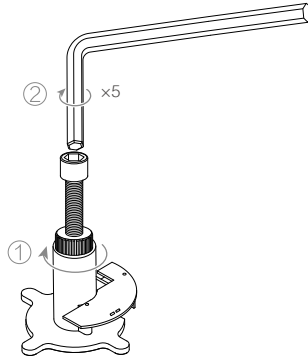

2. Press the initialization button to initialize the system. The system LED will blink solid red when the initialization is completed. If the system LED blinks red, it indicates the signal from remote controller or flight controller is abnormal. Ensure both the "activation switch" and "safety switch" on the remote controller are in the OFF position and that the parachute function of your flight controller is enabled.

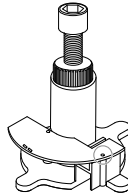

3. Rotate the screwdriver to tighten the trigger compression tool until the system LED blinks solid green. Meanwhile, the other system LED will blink red for 9 seconds and then goes off.

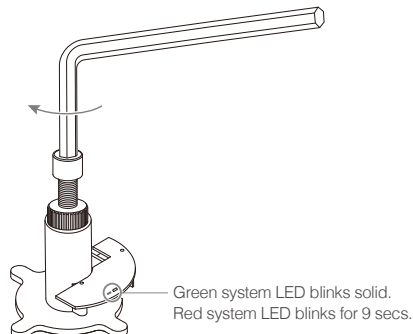

4. It is recommended to test the system before each deployment. Follow the steps below to complete the test:
 - (1) Ensure triggering pin is locked in place and system is connected with flight controller. Unscrew the trigger compression tool for one round (do not unscrew for more than one round, otherwise triggering pin might be damaged when it is released). Make sure that system LED blinks solid green.
 - (2) Toggle and hold the "safety switch" on the remote controller to the ON position. Then toggle the "activation switch" to activate and deploy the system. If the system is deployed successfully, the system LED blinks solid green and red, otherwise it indicates there is connection error, examine the connection to re-run the test until the issue is solved.
 - (3) Power off the flight controller to complete the test. Repeat step 1 to step 3 described in "Setting Up the System Base for Deployment" to reset the system base.
5. Now the triggering pin is in the ready position. Rotate the hex screwdriver counter-clockwise to remove the trigger compression tool from the triggering housing unit.

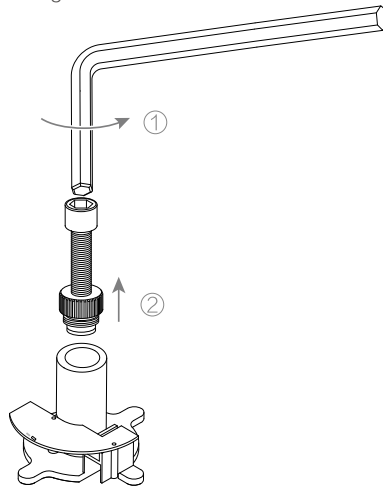

6. Screw the manifold into the system base (as shown in the figure A below).
7. Ensure the manifold is aligned with the marker on the system base (as shown in the figure B below).

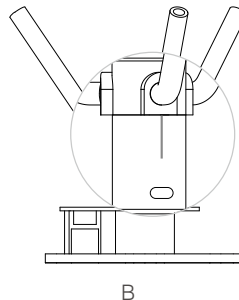
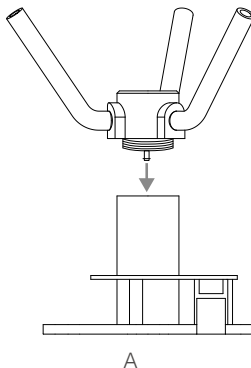

Setting Up the CO₂ Canister



CO₂ canisters are required and not included with the DJI Dropsafe. Only use ISI 16g CO₂ canisters or other 16g CO₂ canisters with specifications as shown in the figure. Improper use of the 16g CO₂ canisters, or using other CO₂ canisters, may cause system error or damage.

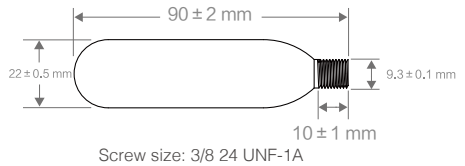

1. Position the parachute housing over the system base, and gently slide the housing into place over the three arms of the manifold. Ensure that the LED window is aligned with the system LEDs.
2. Attach the three side strips onto the housing.

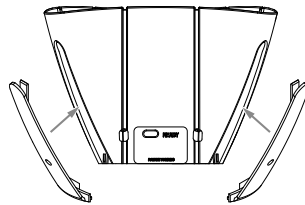
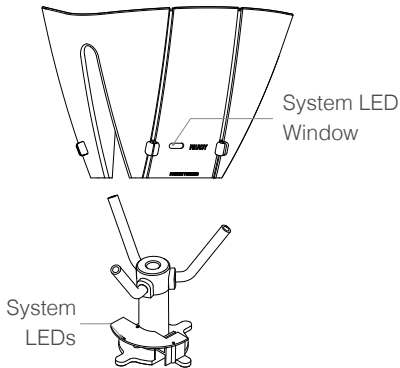

3. Slide the safety pin into the hole on the side strip, and thread it through the hole on the system base. Be aware that the safety pin should always be placed through the strip that is located behind the system LED window.
4. Screw your 16g CO₂ canister into the mounting hole on the manifold.

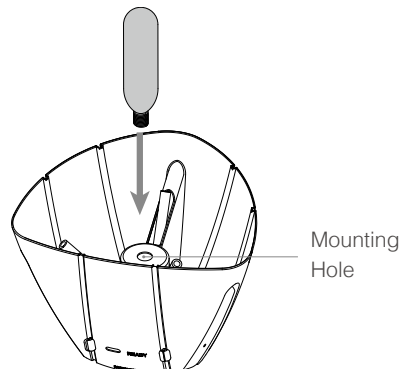
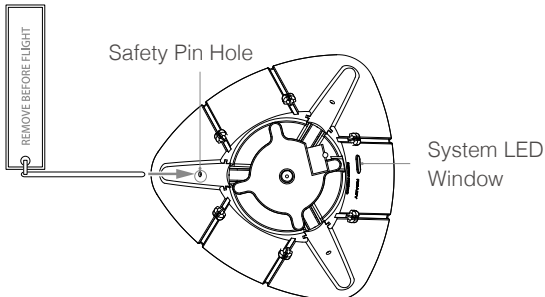

Folding the Parachute

Folding the parachute properly is crucial for effective deployment. Carefully follow the instructions below to fold the parachute.



Watch the video tutorial on how to fold the parachute at www.dji.com/product/dropsafe/video before you fold the parachute for the first time. Failure to follow the folding instructions exactly may result in unsuccessful parachute deployment.

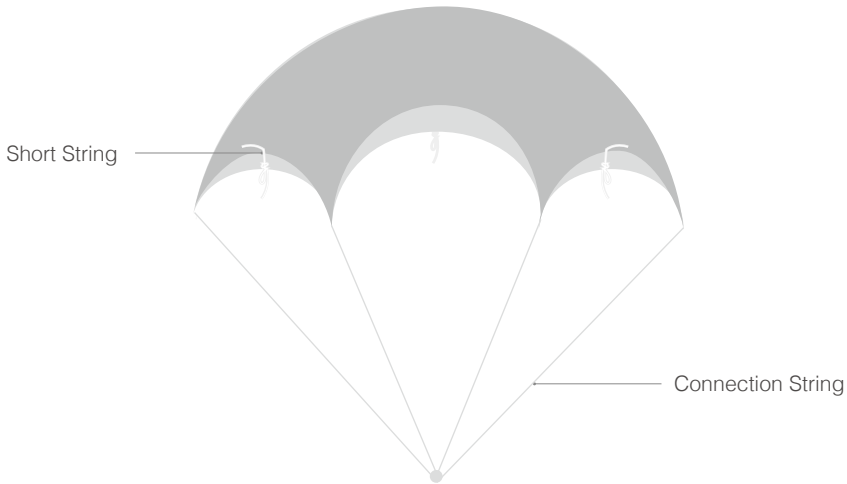

1. Remove the parachute from the package. Open the parachute above the system base, and allow the tip of the CO₂ canister to run through the opening of the parachute. Ensure each short string is aligned with each of the three arms of the manifold.
2. Start folding the parachute and put the packing tool in place. The packing tool should cover each of the three arms of the manifold.
3. Watch the video tutorial on www.dji.com/product/dropsafe/video and carefully follow the instructions in the video to fold the parachute.
4. Attach the short strings to the winglets by tightening the loop around the groove.
5. Remove the packing tool from the manifold. Then attach each winglet to one of the manifold arms.



Remove the packing tool from the manifold before you attach the winglets. Failure to do so may result in unsuccessful parachute deployment.

Connecting DJI Dropsafe to Your Multirotor

1. Attach the connection strings as shown in the video tutorial on www.dji.com/product/dropsafe/video.

2. For example, S900 users should connect and secure each connection string to its specified position, as circled below:

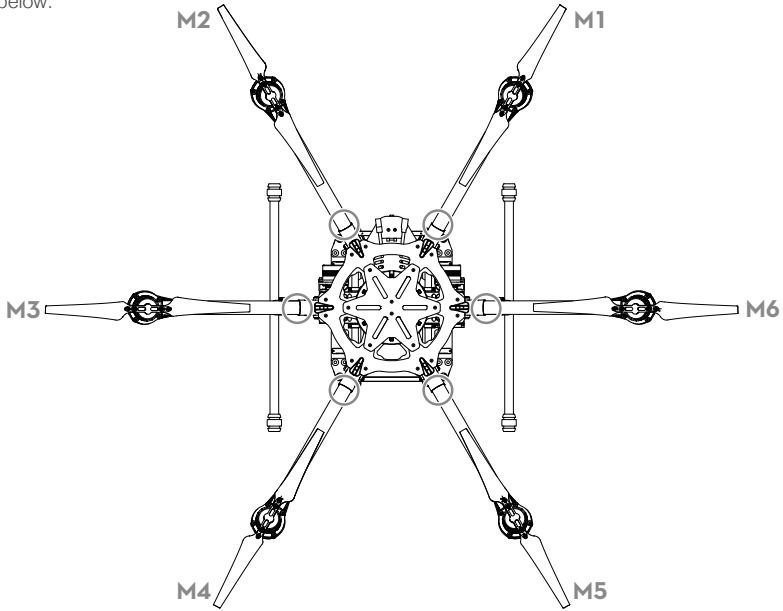

3. For example, S1000 users should connect and secure each connection string to its specified position, as circled below. S1000+ users can secure each connection string in the same locations.

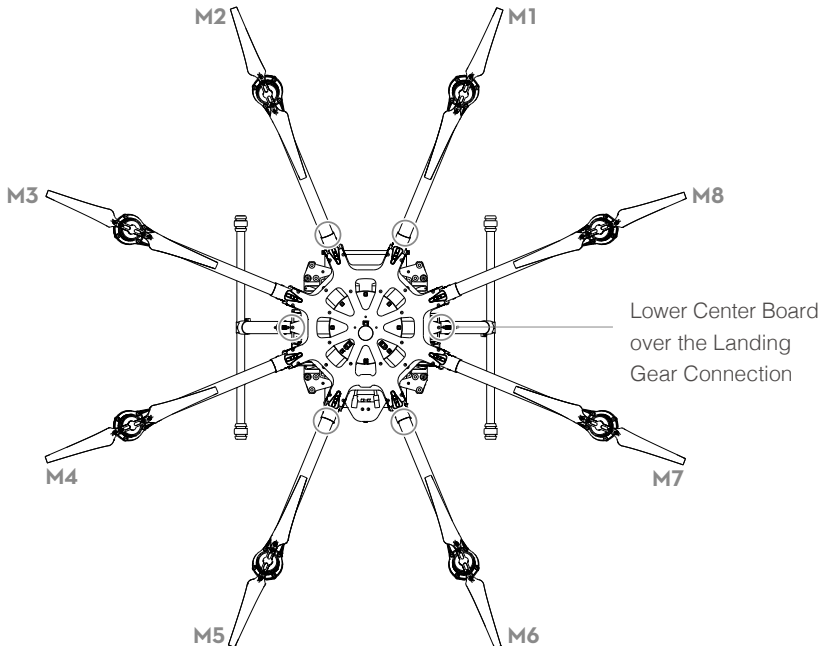

- Pull the connection strings tight and place the strings into the string holders on the parachute housing as shown in the figure below. Adjust the length of the connection strings on both ends of the string holders. Ensure the strings are not loose on either end and will not affect the rotation of the propellers.

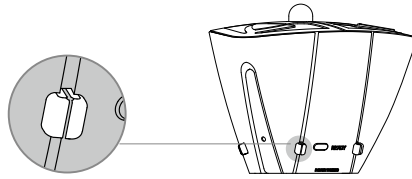

Install Backup Battery

You may wish to activate the backup battery on your RC receiver to provide power in the event that the on-board battery fails. Follow the steps below to install the backup battery:

- Turn on the battery. Backup battery LED will flash blue.
- Plug backup battery into the remote controller receiver.
- Remove safety pin to put the DJI Dropsafe system in "Ready" state.

 Ensure the backup battery is turned on before plugging in the receiver. Otherwise, the backup battery won't work.

 Recharge your backup battery when the battery is low. Connect the micro-USB port on the backup battery with a power source to recharge the backup battery. The backup battery LED will display red when the battery is charging. The backup battery LED will display green when it is fully charged.

DJI Dropsafe System Activation

To activate the system and deploy the DJI Dropsafe, first toggle and hold the "safety switch" on the remote controller to the ON position. Then toggle the "activation switch" to activate and deploy the system.

 In order to prevent accidental deployment before takeoff, a nine second safety countdown is imposed. When the system is initialized, the LEDs will display solid green and blink red for nine seconds. During this period, the DJI Dropsafe will not respond to any commands from the remote controller. The system will only respond to commands after nine seconds. The nine second countdown will restart if either the "activation switch" or "safety switch" is toggled during the countdown.

-  DO NOT activate the DJI Dropsafe system before flight.
- The DJI Dropsafe has a minimum deployment altitude of 6 meters, as tested at sea level. Users should be aware that the minimum deployment altitude is subject to altitude, air pressure, and other factors.
- The table below shows the descending speed of aircraft relative to the payload when the DJI Dropsafe is deployed.

Pay Load	Descending Speed*
3kg	4.4m/s
6kg	5.6 m/s
9kg	6.8m/s
12kg	8.6m/s
15kg	11.7m/s

* The data above is obtained at sea level, in a no wind environment. For the test, the connection strings were attached to the aircraft 17cm away from the center of gravity and were uniform in their circular distribution. The actual speed of descent may vary depending on the external environment or the aerodynamic shape of your equipment.

Appendix

Specifications

















Hardware Requirement

Supported Flight Control System	A2
Supported Multi-rotor	S1000+, S1000, S900

Mechanical and Electrical Features

Input Voltage	5 V
System Weight	550 g
Deployment Time	0.5 s
Minimal Deployment Altitude	6 m

System LED table

System LED	Remark
 —	Solid green System is ready.
 —	Solid red The trigger is not compressed.
 ·····	Blinking red The trigger is not compressed, and the remote controller or flight controller safety function is active.
 ·····	Blinking green The trigger is compressed, and the remote controller or flight controller safety function is active.
  —	Solid green and red Successful deployment.
  ·····	Green and red blink simultaneously Signal not detected from the remote controller, and abnormal flight controller signal.
  ×3	Green and red blink simultaneously for 3 times System powering on, and initialization test complete.
 /  ·····	Alternating green and red Signal not detected from the remote controller or flight controller.
 —  ·····	Solid green and blinking red The remote controller has been used within the nine second safety countdown.
 	LEDs OFF Powered off, or reset required.

User manual is subject to change without prior notice.

You may visit DJI official website to obtain the latest version of user manual.

<http://www.dji.com/product/dropsafe>

