

fi-5000N

Operator's Guide

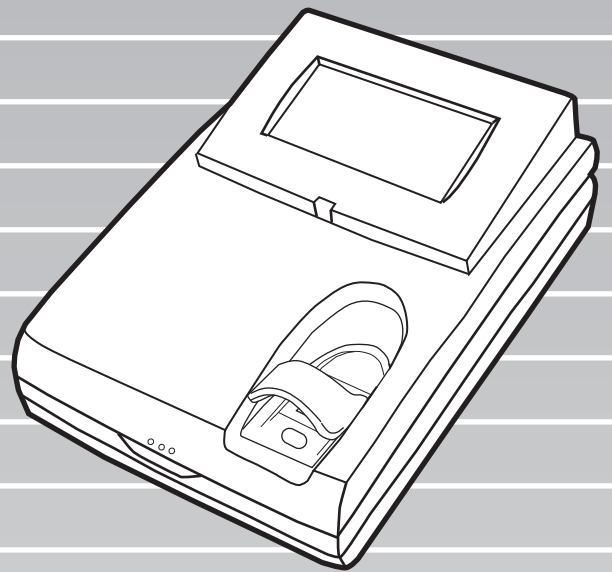

CONTENTS



INTRODUCTION.....	v
■ Regulatory Information	v
■ Note, Liability	vi
■ Safety Precautions	x
Chapter 1 Overview of fi-5000N	1
1.1 Overview.....	2
1.2 Features.....	3
1.3 Examples of Operation.....	4
Chapter 2 Names and Functions of Parts.....	7
2.1 Names of Parts.....	8
2.2 Keyboard	10
Chapter 3 Installing the fi-5000N	11
3.1 Installing the Scanner	12
3.2 Installing the fi-5000N.....	12
3.3 fi-5000N's Settings and Connecting to the Network	14
3.4 Changing the Language Setting.....	18
3.5 Automatic Turning Backlight Off Settings	19
3.6 Beep Sound Configuration	20

3.7	Pull Mode User Authentication Settings	21
3.8	Push Mode Automatic Logout Time Settings	23
3.9	Host Connection Time-out.....	24
3.10	Displaying Device Information	25
3.11	Initialization of fi-5000N.....	26
Chapter 4	Installing and Setting Driver.....	27
4.1	Installing FUJITSU TWAIN 32 Scanner Driver.....	28
4.2	Installing ScandAll 21.....	31
4.3	Installing FUJITSU ISIS Scanner Driver.....	33
4.4	Configuring Scanning Application.....	36
4.5	Uninstalling the Scanner Driver and Scanning Application	39
Chapter 5	Installing and setting the fi-5000N Software	41
5.1	Installing fi-5000N Software.....	42
5.2	fi-5000N Software Overview.....	45
5.3	Adding and Deleting fi-5000N.....	49
5.4	Managing User Information of fi-5000N.....	52
5.5	fi-5000N Administrator Settings.....	57
5.6	Managing Scanner Information	60
5.7	Settings of [Launch Option]	65
5.8	Uninstalling the fi-5000N Software.....	68

Chapter 6	User Authentication	69
6.1	Fingerprint Registration.....	70
6.2	User Authentication by Fingerprint	74
6.3	User Authentication by PIN	75
6.4	Changing the User’s PIN.....	76
Chapter 7	Daily Care.....	77
7.1	Cleaning Materials.....	78
7.2	Parts to Clean and Cleaning Method	79
Chapter 8	Troubleshooting	81
8.1	Error Messages and Remedies	82
8.2	Troubleshooting	88
8.3	Items to Check Before Asking for Repair.....	90
8.4	Checking Labels on the fi-5000N	91
Chapter 9	Specifications	93
9.1	Basic Specifications.....	94
9.2	Installation Specifications	95
9.3	External Dimensions	96
9.4	fi-5000N Software Specifications	97
APPENDIX	Using User Authentication by Fingerprint	AP-1
INDEX	IN-1

Bescheinigung des Herstellers / Importeurs

Für den fi-5000N wird folgendes bescheinigt:

- In Übereinstimmung mit den Bestimmungen der EN45014(CE) funkentstört
- Maschinenlärminformationsverordnung 3. GPSGV: Der höchste Schalldruckpegel beträgt 70 dB (A) oder weniger, gemäß EN ISO 7779.

■ Note, Liability

BEFORE USING THIS PRODUCT, PLEASE READ THIS MANUAL CAREFULLY. IF THIS PRODUCT IS NOT USED CORRECTLY, UNEXPECTED INJURY CAN OCCUR TO USERS OR BYSTANDERS

Keep this manual in a safe place so that it can be easily referred to during use of this product.

While all efforts have been made to ensure the accuracy of all information in this manual, PFU assumes no liability to any party for any damage caused by errors or omissions or by statements of any kind in this manual, its updates or supplements, whether such errors are omissions or statements resulting from negligence, accidents, or any other cause. PFU further assumes no liability arising from the application or use of any product or system described herein; nor any liability for incidental or consequential damages arising from the use of this manual. PFU disclaims all warranties regarding the information contained herein, whether expressed, implied, or statutory.

Use in High-safety Applications

This product has been designed and manufactured on the assumption that it will be used in office, personal, domestic, regular industrial, and general-purpose applications. It has not been designed and manufactured for use in applications (simply called "high-safety applications" from here on) that directly involve danger to life and health when a high degree of safety is required, for example, in the control of nuclear reactions at nuclear power facilities, automatic flight control of aircraft, air traffic control, operation control in mass-transport systems, medical equipment for sustaining life, and missile firing control in weapons systems, and when provisionally the safety in question is not ensured. The user should use this product with adopting measures for ensuring safety in such high-safety applications. PFU LIMITED assumes no liability whatsoever for damages arising from use of this product by the user in high-safety applications, and for any claims or compensation for damages by the user or a third party.

Fingerprint Authentication

Fingerprint authentication technology is employed in the fi-5000N. Data generated from a user's fingerprint information is stored in this product as a source data to authenticate registered users (referred to as "Authentication Data"). To help prevent misappropriation or misuse of the Authentication Data, the product provides the following:

- Authentication Data is encrypted.
- Authentication Data is stored in a manner to make it difficult to search or extract.
- Authentication Data is used for the purpose of identifying PC's on the network, and in a way without sending the Authentication Data to the network.

The Authentication Data may be categorized as personal data and may be subject to various data protection and privacy laws. You are responsible for ensuring all use is in compliance with all such applicable laws.

THE RELIABILITY OF THE FINGERPRINT AUTHENTICATION TECHNOLOGY AND THE MEASURES USED TO PROTECT THE AUTHENTICATION DATA, SUCH AS ENCRYPTION, ARE NOT GUARANTEED ALWAYS TO BE EFFECTIVE AND ACCURATE, OR WITHOUT ERROR. YOU USE THE FINGERPRINT TECHNOLOGY AUTHENTICATION AT YOUR OWN RISK. IN NO EVENT WILL PFU BE LIABLE FOR ANY LOST PROFITS, INCIDENTAL OR CONSEQUENTIAL DAMAGES ARISING FROM OR RELATING TO THE FINGERPRINT TECHNOLOGY, AUTHENTICATION DATA, ANY PERFORMANCE OR LACK OF PERFORMANCE OF THE FINGERPRINT TECHNOLOGY OR ANY MISUSE OR DISCLOSURE OF THE AUTHENTICATION DATA, WHETHER BASED ON CONTRACT, TORT, STRICT LIABILITY OR ANY OTHER CLAIM, EVEN IF PFU IS APPRISED OF SUCH DAMAGES.

Trademarks

Microsoft and Windows are registered trademarks of Microsoft Corporation in the United States and/or other countries.

ISIS and QuickScan are trademarks or registered trademarks of EMC Corporation in the United States. Adobe, the Adobe logo, and Acrobat are either registered trademarks of Adobe Systems Incorporated in the United States and/or other countries.

Other product names are the trademarks or registered trademarks of the respective companies.

How Trademarks Are Indicated In This Manual

References to operating systems (OS) are indicated as follows:

Windows 2000	Microsoft® Windows® 2000 Professional operating system.
Windows XP	Microsoft® Windows® XP Professional operating system (32/64-bit). Microsoft® Windows® XP Home Edition operating system.
Windows Server 2003	Microsoft® Windows Server® 2003 Standard Edition operating system (32/64-bit).
Windows Vista	Microsoft® Windows Vista® Home Basic operating system (32/64-bit). Microsoft® Windows Vista® Home Premium operating system (32/64-bit). Microsoft® Windows Vista® Business operating system (32/64-bit). Microsoft® Windows Vista® Enterprise operating system (32/64-bit). Microsoft® Windows Vista® Ultimate operating system (32/64-bit).
Windows Server 2008	Microsoft® Windows Server® 2008 Standard Edition operating system (32/64-bit).

Where there is no distinction between the different versions of the above operating system, the general term "Windows" is used.

Manufacturer

PFU LIMITED

International Sales Dept., Imaging Business Division, Products Group

Solid Square East Tower, 580 Horikawa-cho, Saiwai-ku, Kawasaki-shi Kanagawa 212-8563, Japan

Phone: (81-44) 540-4538

All Rights Reserved, Copyright© PFU LIMITED 2004-2009

About Maintenance

The user must not perform repairs on this device. Contact the store where you purchased it or an authorized FUJITSU Image Scanner service provider to have repairs done on this product.

Warning Indications Used In This Manual



This indication alerts operators to an operation that, if not strictly observed, may result in severe injury or death.



This indication alerts operators to an operation that, if not strictly observed, may result in safety hazards to personnel or damage to equipment.

Symbols Used In This Manual

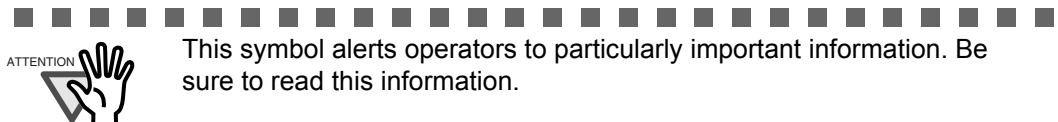

This symbol alerts operators to particularly important information. Be sure to read this information.



This symbol alerts operators to helpful advice regarding operation.



A TRIANGLE symbol indicates that special care and attention is required. The drawing inside the triangle shows the specific caution.



A CIRCLE with a diagonal line inside shows action which users may not perform. The drawing inside or under the circle shows the specific action that is not allowed.



Outline characters on a colored background show instructions users should follow. It may also include the drawing that shows the specific instruction.

Screen Examples In This Manual

The screen examples in this manual are subject to change without notice in the interest of product improvement. If the actual displayed screen differs from the screen examples in this manual, operate by following the actual displayed screen while referring to the User's Manual of the device application you are using. The screenshots in this manual were captured from the FUJITSU TWAIN32 device driver, ScandAll 21 Image Capturing Utility Software, fi-5000N Software, FUJITSU ISIS device driver, QuickScan™ image capturing software.

■ Safety Precautions



Do not damage the AC cable.



A damaged AC cable may cause fire or electric shock. Do not place heavy objects on AC cables, or pull, bend, twist, heat, damage or modify AC cables. Do not use damaged AC cables or power plugs, or install any cables or power plugs to loose wall sockets.

Use only specified AC cables and connector cables.



Use only specified AC cables and connector cables. Failure to use the correct cables might cause electric shock and/or equipment failure. Do not use the AC cable provided with this product for other devices, since this might cause equipment failure and other troubles or an electric shock.

Use this device only at the indicated power voltage. Do not connect to multiple-power strips.



Use this device only at the indicated power voltage and current. Improper power voltage and current might cause fire or electric shock. Do not connect to multiple-power strips.

Do not touch the AC cable with wet hands.



Do not touch the power plug with wet hands. Doing so can cause electric shock.

Wipe any dust from the power plug.



Wipe off any dust from metal parts on the power plug or metal fittings with a soft, dry cloth. Accumulated dust can cause fire or electric shock.

Do not install the device in locations that has oil smoke, steam, humidity, and dust.



Do not install the device in locations subject to oil smoke, steam, humidity, and dust. Doing so might cause a fire or electric shock.

Turn the device OFF if it is damaged.



If the device is damaged for any reason, turn the device off and unplug the power cable. Contact the store where you purchased the device.

Do not put liquids inside the device.



Do not insert or drop metal objects in/on to the device. Do not splash or allow the device to get wet.



If foreign objects (water, small metal objects, liquids, etc.) get inside the device, immediately turn off the device and disconnect the power plug from the power outlet. Then, contact the store where you bought the device or the Maintenance Service Center. Pay particular attention to this warning in households where there are small children.



Do not touch the inside of the device unless necessary.



Do not take apart or modify the device. The inside of the device contains high-voltage components. Touching these components might cause electric shock or fire.

Do not use the device if there is a strange odor.



If you detect excessive heat coming from the device or detect other problems such as smoke, strange smells or noises, immediately turn off the device and disconnect its power plug. Make sure that any smoke coming from it has stopped, before contacting the store where you bought the device or an authorized FUJITSU scanner service provider.



Do not install the device on unstable surfaces.



Make sure that the device is installed on a flat, level surface and that none of its parts extend beyond the surface top, such as a desk or table. Do not install the device on unstable surfaces. Install the device on a level surface that is free of vibration to prevent it from falling.



Install the device on a strong surface that will support the weight of the device and other devices.

Do not place heavy objects or stand on top of the device.



Do not place heavy objects on the device or use the device's surface top to perform other work. Improper installation might cause injuries and equipment failure.

Firmly insert the power plug.



Firmly insert the power plug as far it can go into the power outlet.

Do not use the device immediately after moving it from a cold place into a warm room.



Do not use the device immediately after moving it from a cold place into a warm room. Condensation may occur, which might lead to operating errors. Let the device dry about one or two hours before you use it.

Before moving the device, disconnect the power plug from the power outlet.



Do not move the device with the power and any other cable connected as this can damage the cables, which can later cause fire, electric shock as well as injury. Before moving the device, be sure to disconnect the power plug from the power outlet, and all other cables. Make sure that the floor is free of any obstructions.

Protect the device from static electricity.



Install the device away from strong magnetic fields and other sources of electronic noise. Also, protect the device against any static electricity, which can cause the device to malfunction.

Disconnect the power plug from the power outlet when the device is not used for a long period of time.



When the device is not going to be used for a long period of time, be sure to disconnect the power plug from the power outlet.

Do not install the device in direct sunlight.



Do not install the device under direct sunlight or near heating apparatus. Doing so might cause excessive heat to build up inside the device, which can cause device trouble or even fire. Install the device in a well-ventilated location.

Chapter 1



Overview of fi-5000N

1

1.1 Overview	2
1.2 Features	3
1.3 Examples of Operation	4

1.1 Overview

The function of the fi-5000N is to connect a fi-series scanner to a computer through the network. This framework is shown in the diagram below. This framework is referred to as the fi-5000N system hereinafter.

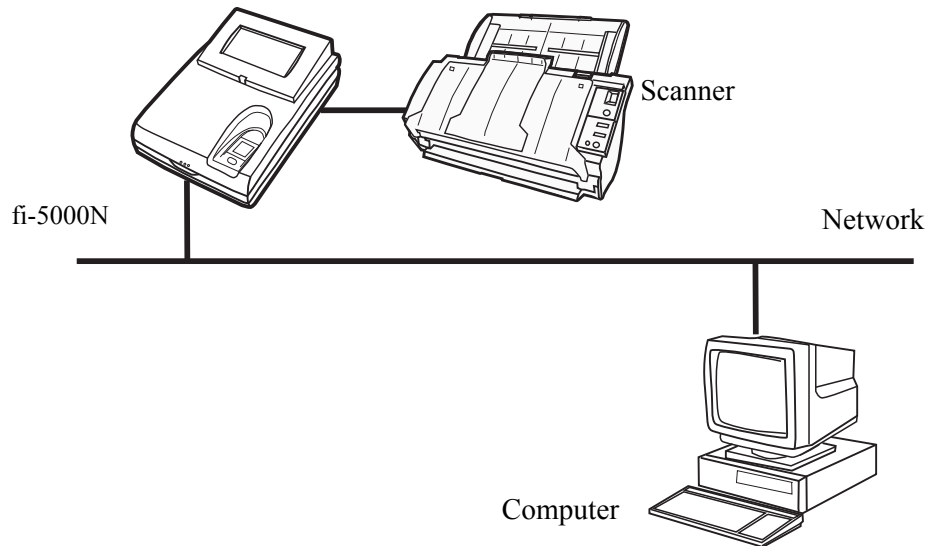

This device connected to a fi-series scanner through the USB interface, can transmit scanned images to a computer over networks. The fi-5000N makes it possible to scan documents without touching a computer at sites where scanning documents are required. Furthermore, only permitted operators can input images as this device has a built-in fingerprint identification mechanism.

With the fi-5000N, you can build up a system whereby you can scan documents easily and securely without operating a computer in places where logon to a computer were required

1.2 Features

1. Simple and secure operator identification with fingerprint authentication

With the fingerprint authentication technology, the user can be easily identified by a touch of a finger. There is no need for special hardware or personal identification numbers that in the majority of cases.

2. High-speed scanning and transmission of data via network

High speed scanning and high speed data transmission via a network becomes a reality with the utilization of USB 2.0 for the scanner interface, and compatibility to 100BASE-TX for the network interface.

3. By leveraging your current system, you can set up a distributed system easily.

With the TWAIN/ISIS interface equipped, you can make transition to remote scanning system that utilizes your current system resources.

4. Easy maintenance with the administrative tools on your computer

You can easily manage the fi-5000N such as registering or deleting fi-5000N's users, or backing up/restoring users' information from the PC by using the bundled fi-5000N Software.

With the fi-5000N Software, you can manage multiple fi-5000N.

1.3 Examples of Operation

There are two ways to perform scanning documents using fi-5000N.

1. Pull mode scanning

Computer with scanning application scan the documents from the scanner on the network and capture the image data. This is called Pull mode because the image data is pulled from the scanner to the computer via the network. In this mode, you can specify if user authentication process is enabled. If enabled, fi-5000N enter into user authentication waiting state when scanning is initiated from the computer. After placing the document on to the scanner (ADF or flatbed depending on your setting) and finishing the user authentication (with your finger or PIN), the scanning will start. (Refer to "3.7 Pull Mode User Authentication Settings" (page. 21).

The major advantages of fi-5000N are security function by fingerprint authentication and ease of operations. By integrating system utilizing fingerprint authentication results, following operations can be possible.

2. Push mode scanning

Operator places documents on to a scanner and press [Scan] button (or [Send to] depending on the setting) to start scanning and to send the captured image data to a computer over the network. This mode is called Push mode because the captured data is sent (pushed) form the scanner to the computer. The operations are easy: Set the document on to the scanner. → Perform the user authentication. → Press the [Scan] button. With these 3 steps, the captured data is sent to the computer. (You can try Push-scan by following the procedures described in Chapter2, "fi-5000N Getting Started" manual.)

The major advantages of fi-5000N are security function by fingerprint authentication and ease of operations. By integrating system utilizing fingerprint authentication results, the following operations can be possible.

1. Switch PCs that receive the image data through the network.

The fi-5000N uses the fingerprint authentication result to identify the scanner operator. Based on identified operator, the fi-5000N can be configured to switch destination PC that receive scanned images.
(Used as a Shared scanner.)

2. Switch image data processing contents.

The fi-5000N can notify to the PC the fingerprint authentication results. Based upon the results, the PC switches the contents of the data processing and/or retains operation records. (such as switching storage folders, creating access rights, charging of fees, logging processing, etc.)

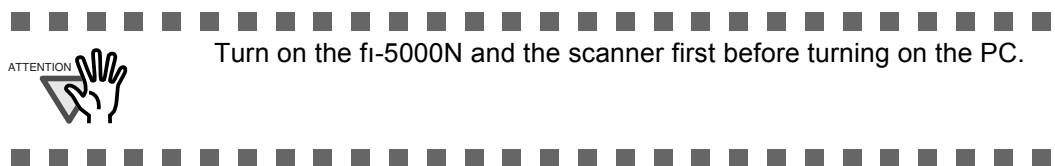

Two types of users are assumed for the fi-5000N: Administrator and the operator of the fi-5000N. The following are expected for each type of user to perform:

■ Administrator

The Administrator is in the position to manage the fi-5000N, the scanner and the operator.

1) Management of the fi-5000N:

Means the maintenance and configuration of this product

- Network configuration
- Message Display language configuration
- fi-5000N name configuration
- Trigger port configuration
- PIN (Personal Identification Number) configuration

2) Management of the Scanner:

Means the maintenance of the fi-series scanner connected to this product and the configuration/verification of:

- Scanner connection
- Settings of the connected scanner
- Adjustment of the scanner
- Consumables and counters of the scanner

3) Management of the Operator:

Means the maintenance of the operators who carry out the scanning.

The four maintenance actions are:

- Registering new operator
- Changing operator information
- Deleting operator information
- Backing up/Restoring operator information

■ Operator (Referred to as "user" in this manual.)

The operator is the one who carries out the image scanning operations as below.

1) Starting up the system

Once the fingerprint is authenticated, the operator can start the application on the system by pressing a button ([Scan] or [Send To]) on the scanner.

2) Management of one's own fingerprint information

The operator can:

- Register his/her own fingerprint data.
- Re-register his/her own fingerprint data.

3) Management of one's personal identification number (PIN)

The operator can change his/her own PIN.

Chapter 2



Names and Functions of Parts

2

2.1 Names of Parts	8
2.2 Keyboard	10

2.1 Names of Parts

This section describes the device's parts.

■ Front

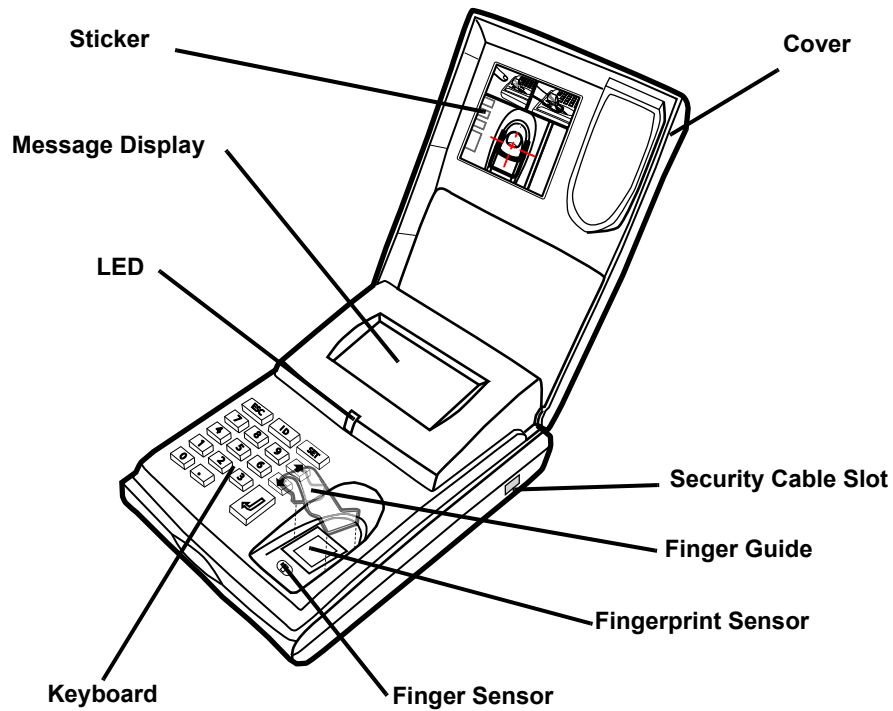

Part Name	Function
Cover	Protects the Keyboard.
Sticker	Correct placement of finger is described.
Message Display	Displays the settings and status of the fi-5000N.
Keyboard	It is used for settings and PIN entry.
Finger Sensor	Verifies finger's correct position.
Fingerprint Sensor	Sensor used for fingerprint recognition.
Security Cable Slot	Used for connecting the security cable.
Finger Guide	Used to guide finger for correct positioning. (This guide is removable.)

■ Rear

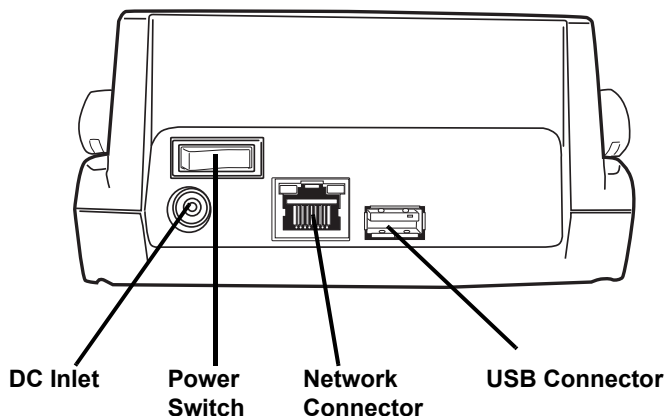

Part Name	Function
DC Inlet	Used for connecting the AC cable.
Power Switch	Used for turning ON/OFF the fi-5000N.
Network Connector	Used for connecting a network cable (LAN).
USB Connector	Used for connecting a USB cable from a scanner.

Chapter 3

Installing the fi-5000N

3.1 Installing the Scanner	12
3.2 Installing the fi-5000N	12
3.3 fi-5000N's Settings and Connecting to the Network	14
3.4 Changing the Language Setting	18
3.5 Automatic Turning Backlight Off Settings	19
3.6 Beep Sound Configuration	20
3.7 Pull Mode User Authentication Settings	21
3.8 Push Mode Automatic Logout Time Settings	23
3.9 Host Connection Time-out	24
3.10 Displaying Device Information	25
3.11 Initialization of fi-5000N	26

3. Connect the USB cable to the USB connector.

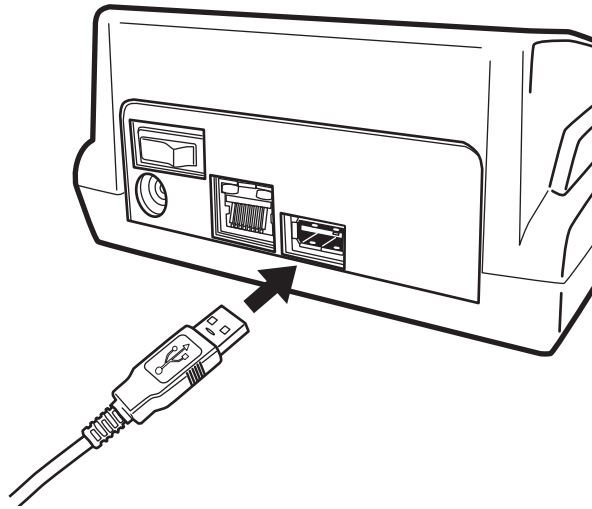

Be sure to use the USB cable provided with the scanner. Correct operation with commercially available cables is not guaranteed.

4. Connect the other end of the USB interface cable to the scanner.



The message "Scanner is disconnected" is displayed on the Message Display of fi-5000N if the scanner is not connected properly, or if the power of the scanner is turned off. Check the connection of the scanner when it happens. Refer to the scanner product manual for details on turning on the power of the scanner.

3.3 fi-5000N's Settings and Connecting to the Network

1. Turn on the power of the scanner and fi-5000N.

Refer to the scanner manual for details on turning on the power of the scanner.

Turn on the fi-5000N by pressing the "I" of the power switch located at the back of the fi-5000N.

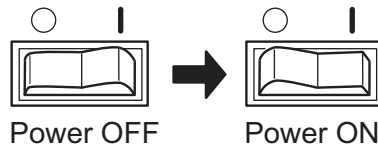

To change the language setting, refer to "3.4 Changing the Language Setting" (page 18)

2. When "The network cable is disconnected" appears on the fi-5000N's Message Display, connect the network cable to the network connector at the back of fi-5000N.

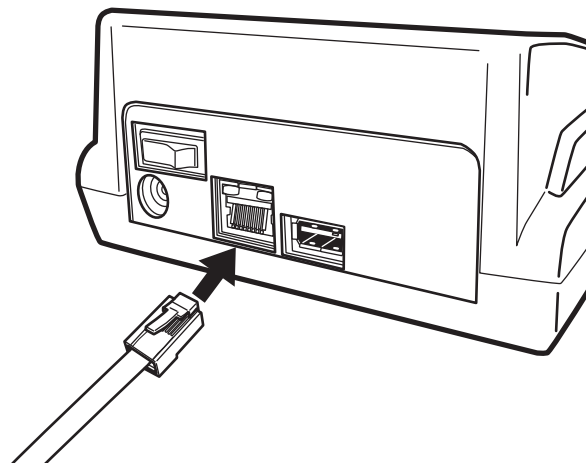

The following screen appears.

If the network support DHCP and the process goes successfully, "Place your finger on the sensor." message appears.

Obtaining IP address
from DHCP server...

Cancel: [ESC]



When the above screen remains still, open the cover of the fi-5000N, and press the [ESC] key.

⇒ The following screen appears, and the IP address obtaining operation is canceled.

Cannot obtain IP
address from DHCP
server.

Setup: [SET]

3. Open the cover and press the [SET] key.

The following settings screen appears.

```
Setup
Register Finger
Change PIN Code
Show Network Config
```

4. With the [↓] key, select "Administrator Setup", and press the [ENT] key.

The screen to enter the Administrator's PIN (personal identification number) appears.

```
PIN: _
Cancel: [ESC]
```

5. Enter the Administrator PIN (the default setting is "5000"), and press the [ENT] key.

The following screen appears.

```
Administrator Setup
Configure Network
Pull Mode Authentic
Auto Logout Time
```

6. Select "Configure Network", and press the [ENT] key.

The following screen appears.

```
Do you want to
use DHCP?
Use DHCP
Use Static IP
```

7. To obtain the IP address automatically from the DHCP (Dynamic Host Configuration Protocol) server, select "Use DHCP" and press the [ENT] key. To set the IP address manually, select "Use Static IP" and press the [ENT] key.

If "Use DHCP" is selected: It is not necessary to specify the IP address, subnet mask and default gateway. Go to step 11.

If "Use Static IP" is selected: The following network configuration screen appears.

```
IP Address:
```



Certain DNS servers and DHCP servers, which do not support DNS update, may cause host name resolution problems when DHCP is specified in IP address settings with fi-5000N.

If you experience such problems, consult with your network administrator and take one of the following measures for fi-5000N and PC:

For fi-5000N,

- 1) Change to DNS server and DHCP server which support DNS update.
- 2) Set the IP address lease time longer in DHCP server settings.
- 3) Use static IP method.

For PC,

- 1) Change to DNS server and DHCP server which support DNS update.
- 2) Set the IP address lease time longer in DHCP server settings and register the PC name on the DNS server.
- 3) Use static IP method.

8. Enter the IP address.

The currently configured IP address is displayed on the entry field. To change, press the [ESC] key once to clear the entry field. Press the [ENT] key after you have entered the correct address.

9. Enter the subnet mask next.

The subnet mask currently configured is displayed on the entry field. To change, press the [ESC] key once to clear the entry field. Press the [ENT] key after you have entered the correct value.

10. The default gateway settings screen appears next.

The portion specified at the IP address and subnet mask will be displayed. Enter the remaining portion of the default gateway and press the [ENT] key.

11. Enter the DNS server addresses (DNS1: Primary; DNS2: Secondary)

The currently configured address is displayed on the entry field. To change, press the [ESC] key once to clear the entry field. Press the [ENT] key after you have entered the correct value.

To skip this step, clear the currently displayed address or enter "0.0.0.0" on the entry field.

If the entered default gateway is correct, the Speed/Duplex (Auto Negotiation) settings screen appears.

```
Select Speed/Duplex
Auto Negotiation
100BASE-TX Full
100BASE-TX Half
```

- Press the [↑] or [↓] key to select one from among "Auto Negotiation", "100BASE-TX Full", "100BASE-TX Half", "10BASE-TX Full" and "10BASE-TX Half", and press the [ENT] key.

Usually "Auto Negotiation" is selected. The following network settings confirmation screen appears when you press the [ENT] key.

```
IP   :XXX.XXX.XXX
MASK:XXX.XXX.XXX
GW   :XXX.XXX.XXX
OK: [ENT] /NG: [ESC]
```

If the hub to connect fi-5000N does not support Auto negotiation, select the supported Speed/Duplex setting.



Select "Auto Negotiation" if the hub supports auto negotiation function. If auto negotiation function is not supported, select the Speed/Duplex that is supported by the hub. The network communication may fail if the following settings are done:

- When "100Base-TX Full" or "Base-TX Full" is selected for a hub that only supports auto negotiation.
- When "Auto Negotiation" is selected for a hub that does not support auto negotiation.
- When the selected Speed/Duplex is not supported by the hub.

For a correct connection and conditions, refer to the manual of the Ethernet hub.



- Confirm the contents of the settings.

To change the settings, press the [ESC] key until it returns to the setting screen of the item to change, and configure again.

If the contents are correct, press the [ENT] key. The following screen appears.

```
Initializing
network...
```

With this, the network settings are completed.



If the fi-5000N is initialized, the settings done in this section will return to their default values. In order not to forget the settings done in this section, make a note of them.

MEMO

IP address:

Subnet mask:

Default gateway

DNS 1:

DNS 2:

When "Use DHCP" is selected in step 7, it is not necessary to note down for IP address, Subnet mask and Default gateway.



3.4 Changing the Language Setting

You can choose the language for the Message Display from English, Japanese, French, German, Italian and Spanish. (The default setting is English.)

To change the language setting, follow the procedure below.

1. Open the cover and press the [SET] key.

The following settings screen appears.

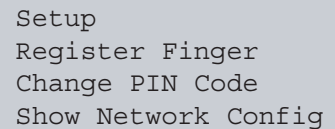

```
Setup
Register Finger
Change PIN Code
Show Network Config
```

2. With the [↓] key, select "Administrator Setup", and press the [ENT] key.

The screen to enter the Administrator's PIN (personal identification number) appears.



```
PIN: _
```

```
Cancel: [ESC]
```

3. Enter the Administrator PIN (the default setting is "5000"), and press the [ENT] key.

The following screen appears.

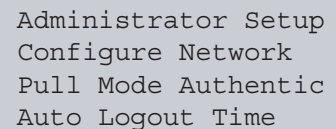

```
Administrator Setup
Configure Network
Pull Mode Authentic
Auto Logout Time
```

4. With the [↓] key, select "Change Language", and press the [ENT] key.

The following screen appears.

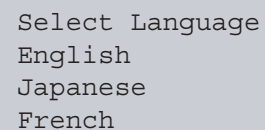

```
Select Language
English
Japanese
French
```

5. Press the [↑] or [↓] key to select the language and press the [ENT] key.

The following screen appears.

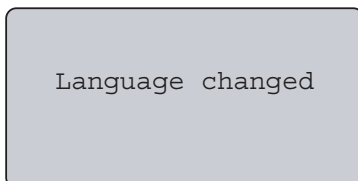

```
Language changed
```

And the language setting is changed.

3.5 Automatic Turning Backlight Off Settings

You can configure the Message Display's backlight to be turned off automatically if no operation is performed for 5 minutes. (The default setting is "Auto off".)

1. Open the fi-5000N's cover and press the [SET] key.

The following settings screen appears.

```
Setup
Register Finger
Change PIN Code
Show Network Config
```

2. With the [↓] key, select "Administrator Setup", and press the [ENT] key.

The screen to enter the Administrator's PIN (personal identification number) appears.

```
PIN: _

Cancel: [ESC]
```

3. Enter the Administrator PIN (the default setting is "5000"), and press the [ENT] key.

The following screen appears.

```
Administrator Setup
Configure Network
Pull Mode Authentic
Auto Logout Time
```

4. With the [↓] key, select "Auto Backlight Off", and press the [ENT] key.

The following screen appears.

```
Turn backlight
automatically off?
Auto off
Always on
```

5. To turn the backlight off automatically after a certain period of time, select "Auto off", to leave the backlight's power always on, select "Always on" and then press the [ENT] key.

The following screen appears.

```
Auto backlight off
setting changed
```

With this, the backlight setting is done.

3.6 Beep Sound Configuration

The beep that sounds each time an operation is done, can be set on or off. (The default setting is "Beep".)

1. Open the fi-5000N's cover and press the [SET] key.

The following settings screen appears.

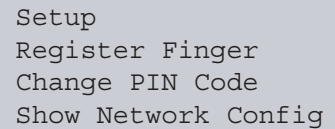

```
Setup
Register Finger
Change PIN Code
Show Network Config
```

2. With the [↓] key, select "Administrator Setup", and press the [ENT] key.

The screen to enter the Administrator's PIN (personal identification number) appears.

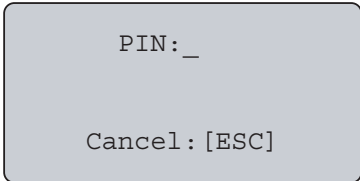

```
PIN: _

Cancel: [ESC]
```

3. Enter the Administrator PIN (the default setting is "5000"), and press the [ENT] key.

The following screen appears.

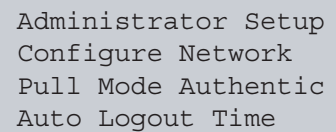

```
Administrator Setup
Configure Network
Pull Mode Authentic
Auto Logout Time
```

4. With the [↓] key, select "Beep On/Off", and press the [ENT] key.

The following screen appears.

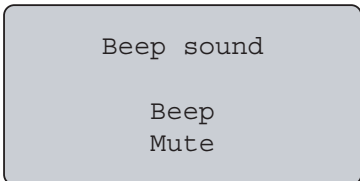

```
Beep sound

Beep
Mute
```

5. To set the beep sound on, select "Beep"; to set it off, select "mute" and then press the [ENT] key.

The following screen appears.

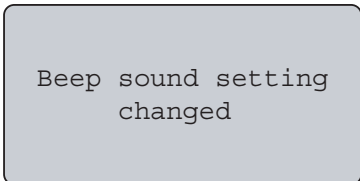

```
Beep sound setting
changed
```

With this, the beep sound setting is done.

3.7 Pull Mode User Authentication Settings

You can set the user authentication function on or off, when performing a "Pull" mode scanning. User authentication function is enabled as the default setting.



There are 2 ways to perform scanning: "Push" mode and "Pull" mode scanning.

In "Push" mode, scanning is started by pressing a scanner's button ([Scan] or [Send to] button) and the scanned image data is sent ("Pushed") to the PC.

On the other hand, in "Pull" mode, scanning is started from the PC by using the scanning application which captures ("Pulls") the image data from the scanner.

The "Push" mode scanning requires user authentication (by fingerprint or PIN) to identify the sender, while the "pull" mode does not necessarily require user authentication. For security measures, you can enable the user authentication function.

To configure the "pull" mode user authentication, follow the procedure below.

1. Open the fi-5000N's cover and press the [SET] key.

The following settings screen appears.

```
Setup
Register Finger
Change PIN Code
Show Network Config
```

2. With the [↓] key, select "Administrator Setup", and press the [ENT] key.

The screen to enter the Administrator's PIN (personal identification number) appears.

```
PIN: _
Cancel: [ESC]
```

3. Enter the Administrator PIN (the default setting is "5000"), and press the [ENT] key.

The following screen appears.

```
Administrator Setup
Configure Network
Pull Mode Authentic
Auto Logout Time
```

3.8 Push Mode Automatic Logout Time Settings

This setting applies only to Push mode scanning. After performing a scanning, if no other operations are done after a certain period of time, the current user will be logged out automatically. You can specify this waiting time by following the procedure below.

The default time limit for an automatic logout is 0 second.

1. Open the fi-5000N's cover and press the [SET] key.

The following settings screen appears.

```
Setup
Register Finger
Change PIN Code
Show Network Config
```

2. With the [↓] key, select "Administrator Setup", and press the [ENT] key.

The screen to enter the Administrator's PIN (personal identification number) appears.

```
PIN: _
```

```
Cancel: [ESC]
```

3. Enter the Administrator PIN (the default setting is "5000"), and press the [ENT] key.

The following screen appears.

```
Administrator Setup
Configure Network
Pull Mode Authentic
Auto Logout Time
```

4. With the [↓] key, select "Auto logout time", and press the [ENT] key.

The following screen appears.

```
Auto logout time
(0-60) [seconds]
```

```
0 _
```

5. With the keyboard, input the waiting time before logging out (from 0 to 60 seconds) and press the [ENT] key.

The following screen appears.

```
Auto logout time
setting changed
```

With this, the automatic log out time setting is done. The setting will take effect from the next scanning.

3.9 Host Connection Time-out

When a login is performed with authentication by fingerprint or PIN, the fi-5000N waits a certain period of time for a connection response from the host computer. You can specify this waiting time by following the procedure below.

If there is no response from the host computer during the specified waiting time, "Host Connection failure due to time-out" message will appear on the Message Display.

The default waiting time for the host's connection response is 3 seconds.

1. Open the fi-5000N's cover and press the [SET] key.

The following settings screen appears.

```
Setup
Register Finger
Change PIN Code
Show Network Config
```

2. With the [↓] key, select "Administrator Setup", and press the [ENT] key.

The screen to enter the Administrator's PIN (personal identification number) appears.

```
PIN: _
```

```
Cancel: [ESC]
```

3. Enter the Administrator PIN (the default setting is "5000"), and press the [ENT] key.

The following screen appears.

```
Administrator Setup
Configure Network
Pull Mode Authentic
Auto Logout Time
```

4. With the [↓] key, select "Host time-out", and press the [ENT] key.

The following screen appears.

```
Host connection
time-out
(1-60) [sec]
3_
```

5. With the keyboard, input the waiting time before the time-out is performed (from 0 to 60 seconds) and press the [ENT] key.

The following screen appears.

```
Host connection
time-out
setting changed
```

With this, the host connection time-out setting is done.
The setting will take effect from the next login.

3.10 Displaying Device Information

With the procedure below, the following information can be displayed in the Message Display:

- The network setting status
- The network name of fi-5000N
- The firmware version
- The status of the connected scanner

1. Open the fi-5000N's cover and press the [SET] key.

The following settings screen appears.

```
Setup
Register Finger
Change PIN Code
Show Network Config
```

2. With the [↓] key, select one of the following items, and press the [ENT] key.

- (1) To display the network setting status, select "Show Network Config." (For details about changing the network settings, refer to "3.3 fi-5000N's Settings and Connecting to the Network" (page 14))
- (2) To display the network name of fi-5000N, select "Show Device Name".(For details about changing the network name, refer to "5.5 fi-5000N Administrator Settings" (page 57))
- (3) To display the firmware version, select "Firmware Version".
- (4) To display the status of the connected scanner, select "Show Scanner Info."

```
Setup
Register Finger
Change PIN Code
Show Network Config
Show Device Name
Firmware Version
Show Scanner Info
Administrator Setup
```

The selected information will appear on the Message Display.

When the information extends to many pages, press the [ENT] key to display the next page.

If the [ENT] key is pressed at the last page, it will return to the screen on step 1.

Chapter 4

Installing and Setting Driver

In order to scan documents from the scanner connected to fi-5000N, it is necessary to install the scanner driver and the application software onto the PC.

There are two types of scanner drivers and applications:

Scanner Driver:	Application:
FUJITSU TWAIN 32 Scanner Driver	ScandAll 21 (For FUJITSU TWAIN 32)
FUJITSU ISIS Scanner Driver	QuickScan Pro™ (For FUJITSU ISIS)

Install the appropriate scanner driver for the application you will use.

If necessary, install one of the applications mentioned above.



- Please download the latest version of the scanner driver from our website.
- QuickScan Pro™ is not bundled with this product. Use the software bundled with the scanner.
Refer to the "Getting Started" provided with the scanner for installation details.
- If you use ScandAll 21, install the one included in the Setup CD-ROM provided with this product. Changes to support fi-5000N is included with this version.
- When configuring the network, do not allocate multiple IP addresses to the personal computer used for scanning.
- If the OS is Windows XP, do not let another user log on using the [Switch User] function during scanning.



4.1 Installing FUJITSU TWAIN 32 Scanner Driver	28
4.2 Installing ScandAll 21	31
4.3 Installing FUJITSU ISIS Scanner Driver	33
4.4 Configuring Scanning Application	36
4.5 Uninstalling the Scanner Driver and Scanning Application.....	39

3. Click [INSTALL PRODUCTS].

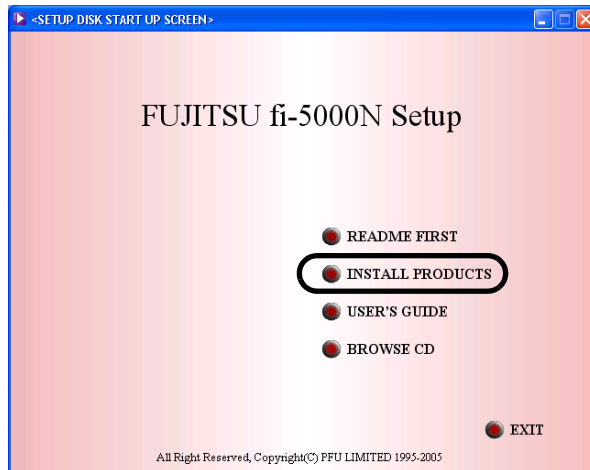

4. Click [TWAIN Driver] on the window below.



5. Select a language used for installation on [Choose Setup Language] window and click [OK].

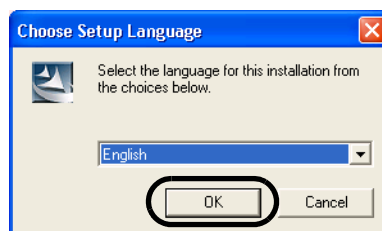

6. Follow the instructions on the window to install the application.

7. When the [InstallShield Wizard Complete] window appears, click [Finish].

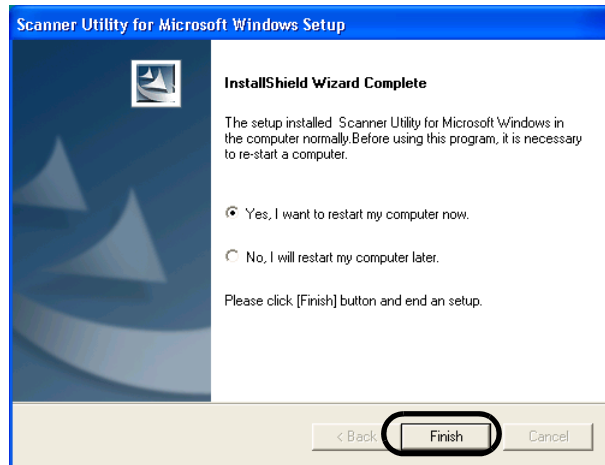

⇒ Your PC will be restarted. Do not remove the Setup CD-ROM until your PC has completely restarted.



To complete the installation successfully, you must restart your PC.



Installation of the scanner driver is completed.



In order to use the scanner, it is also necessary to have an application that complies with the TWAIN standard.

Use "ScandAll 21" bundled with the fi-5000N.

To install ScandAll 21, refer to "4.2 Installing ScandAll 21" (page 31).



4.2 Installing ScandAll 21

"ScandAll 21" is an image capturing software that complies with the TWAIN standard. The FUJITSU TWAIN 32 scanner driver enables you to capture images with a FUJITSU image scanner fi-series product.



- Even if you find ScandAll 21 bundled with the scanner, use ScandAll 21 that comes with this product.
- When using Windows 2000 or Windows XP, log on as a user with "Administrator" privileges (privileges of the administrator of your PC).

1. Insert the Setup CD-ROM into the CD drive.

⇒ <SETUP DISK START UP SCREEN> appears.

2. Click [INSTALL PRODUCTS].

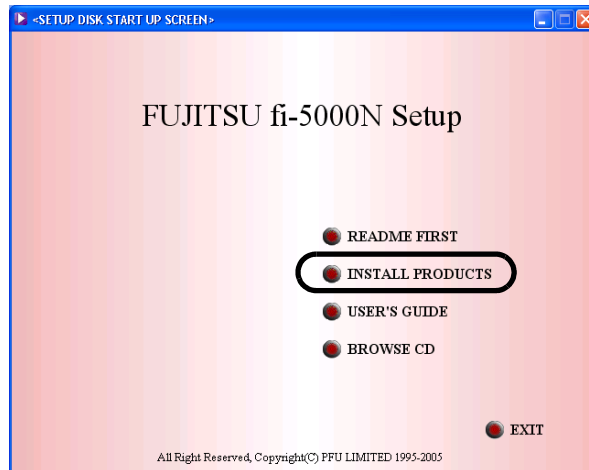

3. Click [ScandAll 21] on the window below.



-
4. Select a language used for installation on [Choose Setup Language] window and click [OK].

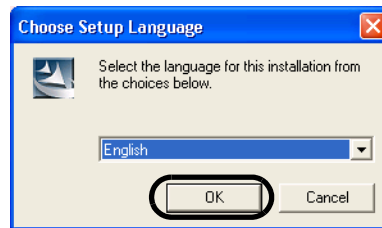

5. Install the application following the instructions on the window.
6. When the [InstallShield Wizard Complete] window appears, click [Finish].

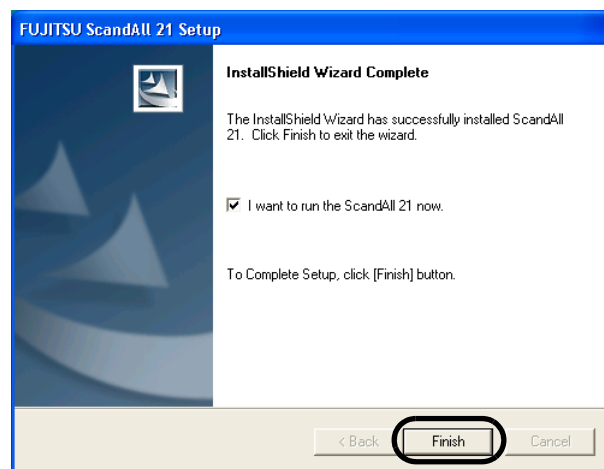

 ATTENTION For finishing the installation, it may be necessary to restart your PC. Follow the instructions on the window.

4.3 Installing FUJITSU ISIS Scanner Driver

■ Preparation

Before starting the installation, prepare the Setup CD-ROM

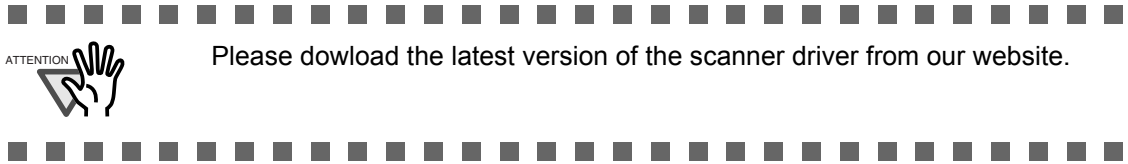

■ Installing

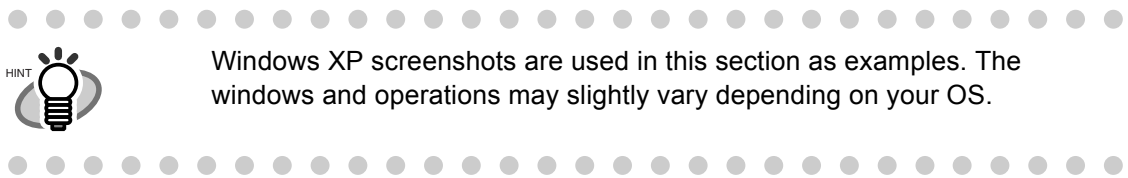

1. Turn on the power of the PC, and log on to Windows.

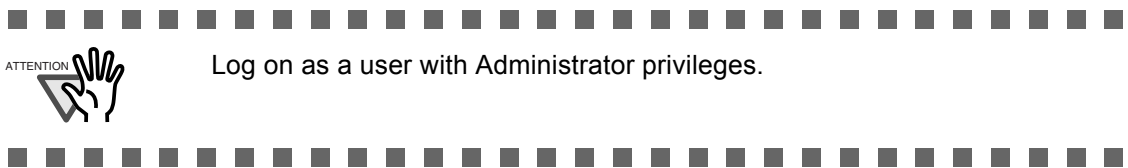

2. Insert the Setup CD-ROM into the CD drive.

⇒ <SETUP DISK START UP SCREEN> appears.

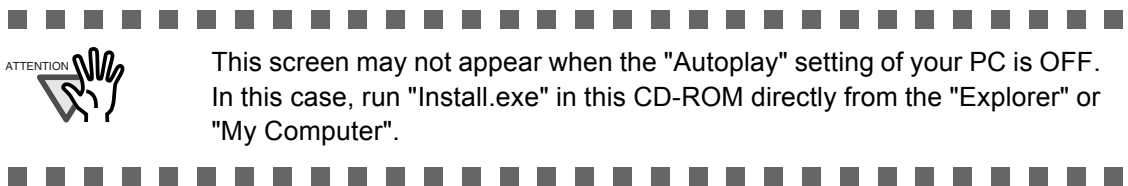

3. Click [INSTALL PRODUCTS].

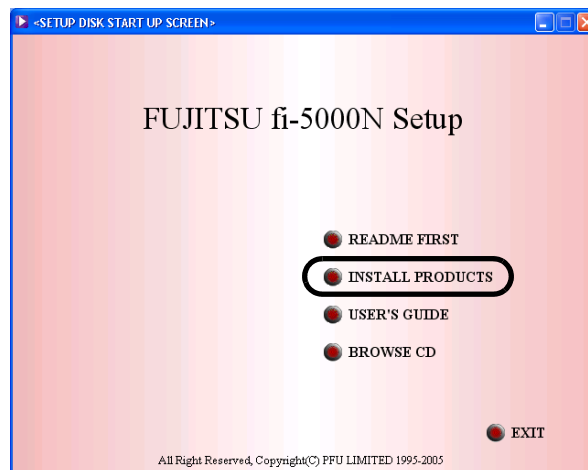

4. Click [ISIS Driver] on the window below.



5. Select a language used for installation on [Choose Setup Language] window and click [OK].

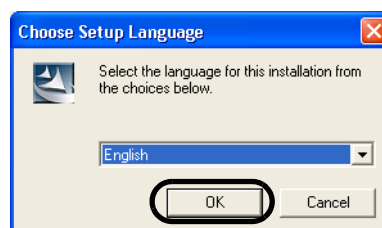

6. Follow the instructions on the window to install the application.

7. When the [Setup Complete] window appears, click [Finish].

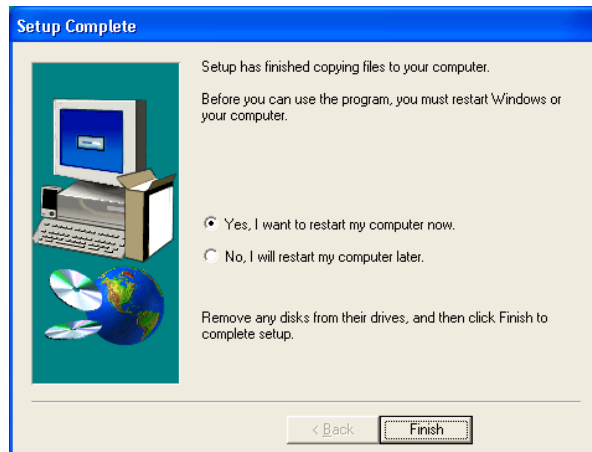

- ⇒ Your PC will be restarted. Do not remove the Setup CD-ROM until your PC has completely restarted.

Installation of the scanner driver is completed.



In order to use the scanner, it is also necessary to have an application that complies with the ISIS standard. you can install "QuickScan Pro™" bundled with the scanner.

4.4 Configuring Scanning Application

Before performing a scanning operation, select the scanner from the scanning application. The following describes how to select the scanner with respect to the FUJITSU TWAIN32 scanner driver and the FUJITSU ISIS scanner driver.



The selection method may differ from the description below according to the scanning application being used. Refer to the manual or the help file of the scanning application being used.

■ For FUJITSU TWAIN32 Scanner Driver

This description uses the scanning application "ScandAll 21" as an example.

1. Start the application.

From the [Start] menu, select [All Programs] → [Scanner Utility for Microsoft Windows] → [ScandAll 21].

2. From the menu, display the "Select Source" dialog box.

Select [Scan] → [Select Source].

3. Select the scanner to be used.

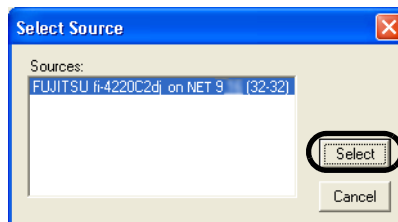

The scanner connected to fi-5000N is displayed as "FUJITSU" + "Device Name" + "on NET...". Select the name, and click the [Select] button.

The selection of scanner is completed.

With the scanning application, the scanner can be used in the same way as a scanner that is directly connected to a PC. (Pull mode Scanning)



The scanner to be used must be specified as "Favorite" on "Select Scanner" tab of "fi-5000N Configuration Tool".

Scanner specified as "Favorite" appears in "Select Source" dialog box.

When Pull mode scanning is enabled, user authentication is required. Perform user authentication with fingerprint or PIN. (To change the settings, refer to "3.7 Pull Mode User Authentication Settings" (page 21))



For details on scanning documents and configuring the scanning application, refer to the "Operator's Guide", "FUJITSU TWAIN32 Scanner Driver Installation Guide", or "ScandAll 21" help supplied with the scanner.

■ For FUJITSU ISIS Scanner Driver

This description uses the scanning application "QuickScan Pro™" as an example.

1. Start the application.

From the [Start] menu, select [All Programs] → [QuickScan] → [QuickScan].

2. From the menu, display the "Scanner Selection" dialog box.

Select [Scan] → [Select Source].

3. Select the scanner to be used.

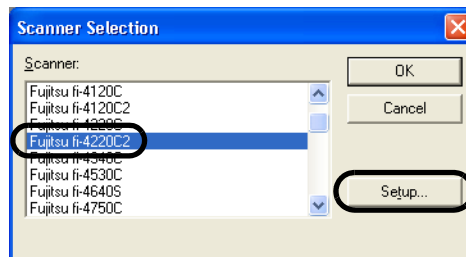

The scanner connected to fi-5000N is displayed as "Fujitsu + Device Name". Select the name, and click the [Setup...] button.

⇒ The following window appears

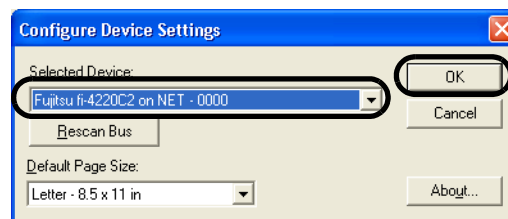

In this window, the scanner name is displayed as "Fujitsu + Device Name + On NET". Select the name, and click the [OK] button.

Selection of the scanner is completed.

With the scanning application, the scanner can be used in the same way as a scanner that is directly connected to a PC.



The scanner to be used must be specified as "Favorite" on "Select Scanner" tab of "fi-5000N Configuration Tool".
Scanner specified as "Favorite" appears in the "Select Source" dialog box. When Pull mode scanning is enabled, user authentication is required. Perform user authentication with fingerprint or PIN. (To change the settings, refer to "3.7 Pull Mode User Authentication Settings" (page 21))



For details on scanning documents and configuring the scanning application, refer to the "Operator's Guide", or "QuickScan" help supplied with the scanner.

Chapter 5



Installing and setting the fi-5000N Software

To control a fi-5000N connected to the network from your PC, and to scan with the scanner connected to the fi-5000N, install the "fi-5000N Software" on:

- The PC of fi-5000N's Administrator
- The PCs used by the scanner's users

This chapter describes the installation and operation procedures of the fi-5000N Software.



5.1 Installing fi-5000N Software	42
5.2 fi-5000N Software Overview	45
5.3 Adding and Deleting fi-5000N	49
5.4 Managing User Information of fi-5000N	52
5.5 fi-5000N Administrator Settings	57
5.6 Managing Scanner Information	60
5.7 Settings of [Launch Option]	65
5.8 Uninstalling the fi-5000N Software	68

5.1 Installing fi-5000N Software

■ Preparation

Before starting the installation, check the following contents.

- Prepare the Setup CD-ROM

■ System Requirements

The system requirements for the fi-5000N is as follow.

- Operating System
 - Microsoft® Windows® 2000 Professional operating system
 - Microsoft® Windows® XP Professional operating system (32/64-bit)
 - Microsoft® Windows® XP Home Edition operating system
 - Microsoft® Windows Server® 2003 Standard Edition operating system (32/64-bit)
 - Microsoft® Windows Vista® Home Basic operating system (32/64-bit)
 - Microsoft® Windows Vista® Home Premium operating system (32/64-bit)
 - Microsoft® Windows Vista® Business operating system (32/64-bit)
 - Microsoft® Windows Vista® Enterprise operating system (32/64-bit)
 - Microsoft® Windows Vista® Ultimate operating system (32/64-bit)
 - Microsoft® Windows Server® 2008 Standard Edition operating system (32/64-bit)
- RAM
 - 128 MB or higher

■ Installing



Windows XP screenshots are used in this section as examples. The windows and operations may slightly vary depending on your OS.

1. Turn on the power of the PC, and log on to Windows.



- To support more scanners and improve the product, fi-5000N Software is subject to change. Please visit our website for the latest version of the software.
- Log on as a user with Administrator privileges.

5. Select a language used for installation on [Choose Setup Language] window and click [OK].



6. Follow the instructions on the window to install the application.
7. When the [InstallShield Wizard Complete] window appears, click [Finish].

Installation of the fi-5000N Software is completed.

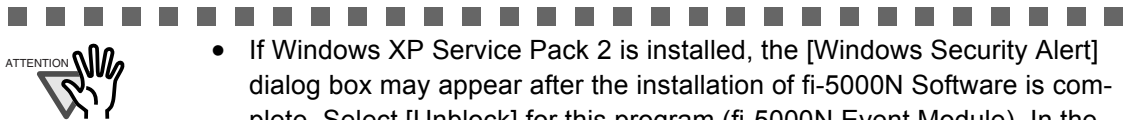

- If Windows XP Service Pack 2 is installed, the [Windows Security Alert] dialog box may appear after the installation of fi-5000N Software is complete. Select [Unblock] for this program (fi-5000N Event Module). In the case where [Keep Blocking] is selected, the personal computer cannot communicate with fi-5000N.

If you select [Keep Blocking], mark "fi-5000N Event Module" listed under [Programs and Services:] on the [Exceptions] tab of [Windows Firewall]. If you select [Ask Me Later], the same message will appear when you log in as the user with "Administrator" authority again. Then, select [Unblock].



5.2 fi-5000N Software Overview

■ Starting fi-5000N Configuration Tool

To start the fi-5000N software, from the [Start] menu, select [All Programs] → [fi-5000N Software] → [fi-5000N Configuration Tool].

■ [Select Scanner] Tab (Main Screen)

This screen (in which the [Select Scanner] tab is selected) is the main screen. All kinds of administrative settings of fi-5000N can be done from this screen.

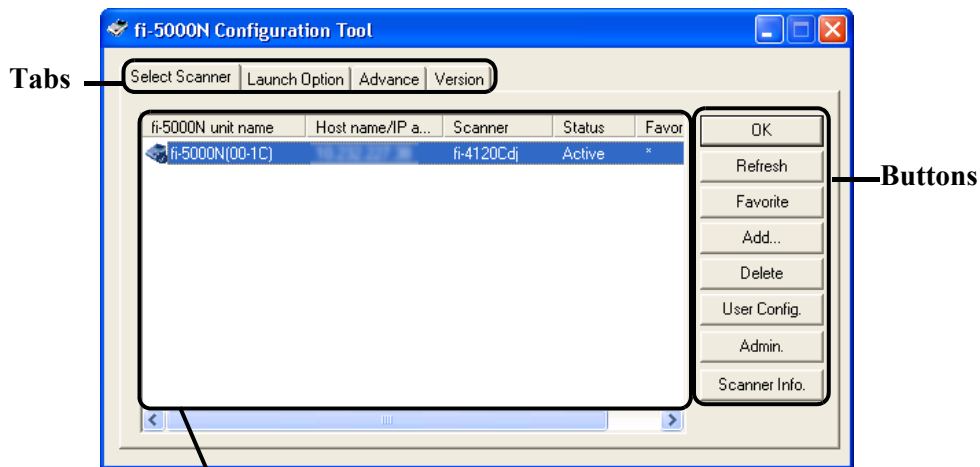

List View

Displays the fi-5000N connected to the network, and network setting information and status.

Name of Item	Function
[OK] button	Closes the screen and exits the fi-5000N Configuration Tool.
[Refresh] button	Updates and displays the latest information of the List View.
[Favorite] button	Selects a scanner to use among the scanners connected to the network. With the device name selected, when you click this button, a "*" is displayed in the "Favorite" column, and it is configured as the default scanner. When using multiple scanners, this button helps you to switch easily to other scanners.
[Add] button	Adds a new fi-5000N to the List View. There is no need to add because the fi-5000N in the same subnet as the PC is displayed automatically in the list. To add an fi-5000N which is in other subnet, use this button.

Name of Item	Function
[Delete] button	Deletes the selected fi-5000N from the list. (An fi-5000N cannot be deleted if it is in the same subnet as your PC.)
[User Config.] button	Registers/changes/deletes user information of the selected fi-5000N. Can be used only by the Operating Administrator. The Administrator PIN is necessary.
[Admin.] button	Changes the name of the selected fi-5000N, network settings, and Administrator PIN. Also, user information can be backed up and restored. Can be used only by the Administrator. The Administrator PIN is necessary.
[Scanner Info.] button	Displays the information of the scanner that is connected to fi-5000N. (It can be used by both, Administrator and users) Consumables counters resetting, offset settings and power saving settings can also be done. (Only by the Administrator)

■ [Launch Option] Tab

The scanning application to be started when the button on the scanner ([Scan] or [Send To]) is pressed, can be configured from this screen.

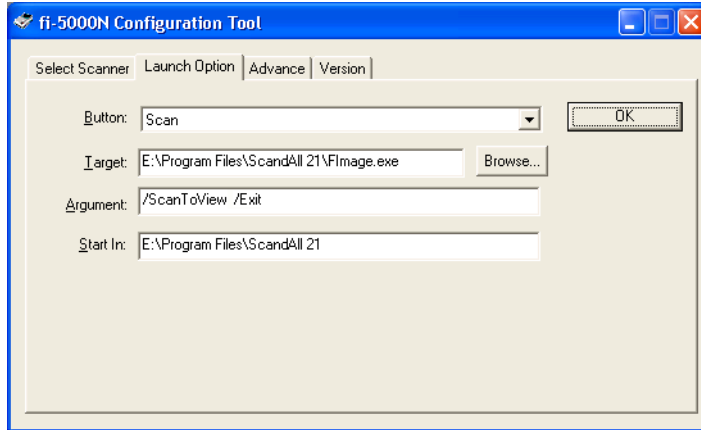

Name of Item	Function
Button:	Selects the button to be configured from among "Scan", and "Send To 1 - Send To 9". You must set the following "Target", "Argument" and "Start In", otherwise no application will start up.
Target:	Specifies the file name of the application to be started.
Argument:	Specify according to the specifications of the application to be started. Refer to "5.7 Settings of [Launch Option]" (page 65) when using ScandAll 21.
Start In:	Specify according to the specifications of the application to be started. Note that start in folder is specified for creating the image file when using ScandAll 21.

■ [Advance] Tab

When receiving image data, the trigger port number for the fi-5000N, may conflict with other applications.

This setting is used to change the trigger port number on the PC.

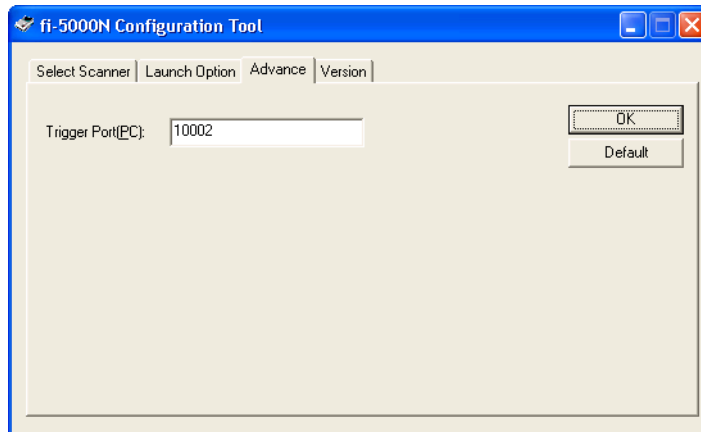

Name of Item	Function
Trigger port (PC):	Used to specify a trigger port number on the PC.
[Default] button:	Resets to the default number.



When changing the trigger port number on the PC, you must also change the trigger port on the fi-5000N. Refer to "5.5 fi-5000N Administrator Settings" (page 57). If the both port numbers are not the same, the fi-5000N will not work correctly.

■ [Version] Tab

This tab shows the version information of the fi-5000N Configuration Tool.

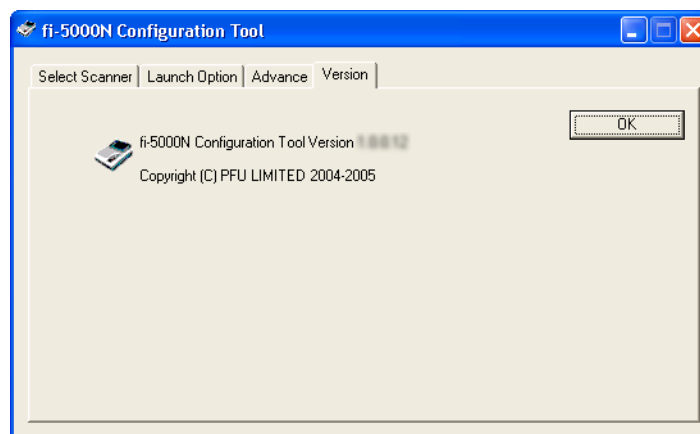

5.3 Adding and Deleting fi-5000N

When a fi-5000N is in the same subnet as the PC, it is automatically recognized and displayed in the List View. However, when it is in other subnet, add or delete with the following procedure.

■ Adding fi-5000N

1. Click the [Add] button on the main screen of fi-5000N Configuration Tool.

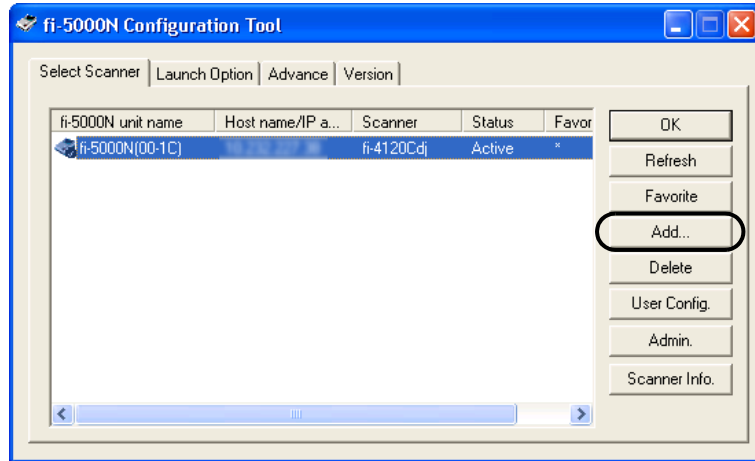

2. Specify the IP address or host name of the fi-5000N to be added.

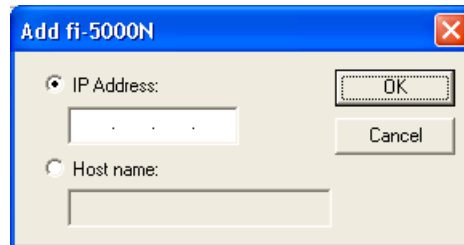

Select either the "IP Address:" or "Host Name", and enter the necessary information.

Example of entry: IP Address: 192.168.1.100

Host name: fi-5000n-00-01.fi-domain.xx.jp



Certain DNS servers and DHCP servers, which do not support DNS update, may cause host name resolution problems when DHCP is specified in IP address settings with fi-5000N.

If you experience such problems, consult with your network administrator and take one of the following measures for fi-5000N and PC:

For fi-5000N,

- 1) Change to DNS server and DHCP server which support DNS update.
- 2) Set the IP address lease time longer in DHCP server settings.
- 3) Use static IP method.

For PC,

- 1) Change to DNS server and DHCP server which support DNS update.
- 2) Set the IP address lease time longer in DHCP server settings and register the PC name on the DNS server.
- 3) Use static IP method.

3. Click the [OK] button.



There is no need to add it manually as it is automatically detected if it is on the subnet.

■ Deleting fi-5000N

1. Select the fi-5000N you want to delete from the List View of the main screen of fi-5000N Configuration Tool.

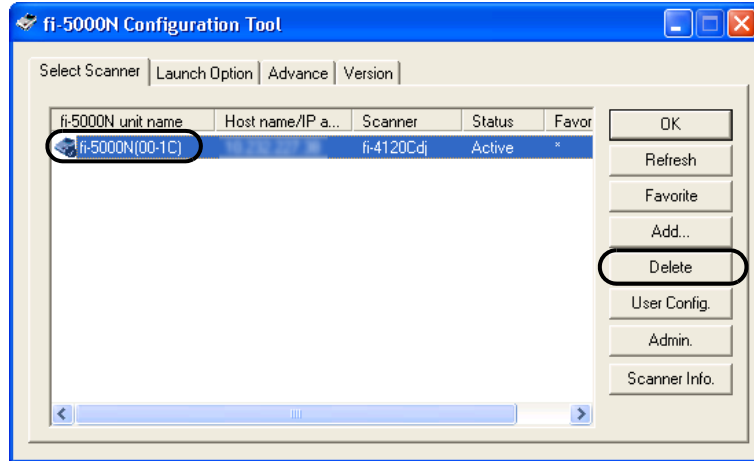

2. Click the [Delete] button.
3. Click [Yes] when the confirmation message appears.

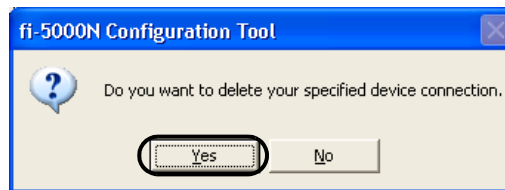

You cannot delete the fi-5000N which is in the same subnet as your PC.

5.4 Managing User Information of fi-5000N

You can register, change or delete the information of users on the fi-5000N using the user configuration function.

To use this function, the Administrator PIN is required.

■ How to Start

1. Select fi-5000N from the List View on the main screen on fi-5000N Configuration Tool, and click the [User Config.] button.

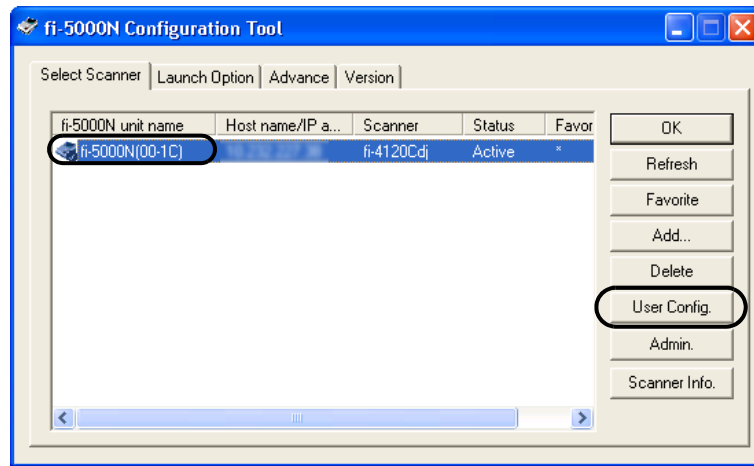

2. The following screen appears. Enter the Administrator PIN, and click the [OK] button.

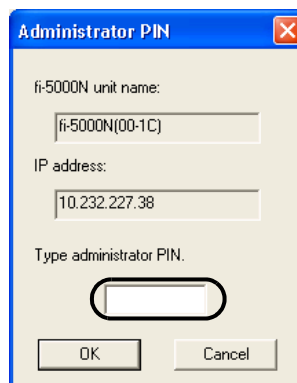

The default Administrator PIN is "5000".
You can use [Admin.] button to change it.
Refer to "5.5 fi-5000N Administrator Settings" (page 57) for more details.

⇒The following screen appears.

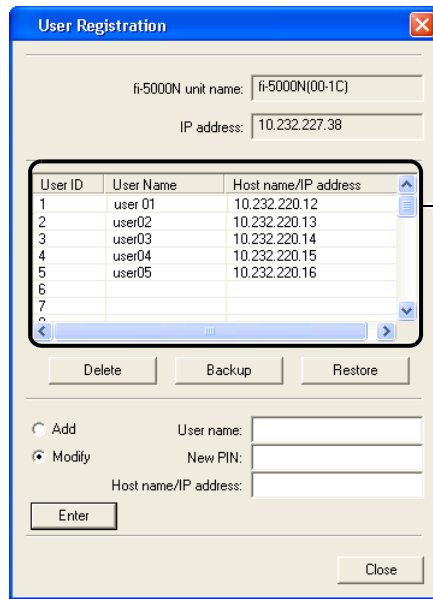

List View
The user names registered in fi-5000N are displayed in a list.

The following settings can be configured.

■ Registering Users

Register a new user onto the fi-5000N with the following procedure.

1. Select [Add].



2. Enter the "User name", "New PIN", and "Host name/IP address", and click the [Enter] button.

User Name	Enter the user name up to 16 characters. You cannot leave it blank.
New PIN	Fill in the User PIN up to 6 digits. You cannot leave it blank.
Host name/ IP address	Enter the IP address or the host name of the PC used by the user. You cannot leave it blank. Example: IP Address: 192.168.1.200 Host name: pc.fi-domain.xx.jp

⇒ The registering process runs.



It is possible to register a maximum of 32 users.

■ Changing User Information

You can change the information of registered users with the following procedure.

1. Select (click) the user name you want to change from the List View.

2. Change either the "New PIN" or the "Host name/IP address" when the user name selected in the "User Name:" column is displayed, and click the [Enter] button.

New PIN	Fill in the User PIN up to 6 digits. You cannot leave it blank.
Host name/IP address	Enter the IP address or the host name of the PC used by the user. You cannot leave it blank. Example: IP Address: 192.168.1.200 Host name: pc.fi-domain.xx.jp



You cannot change the user ID and the user name.

3. Click [Yes] when the confirmation message appears.

■ Deleting Users

You can delete the information of registered users with the following procedure.

1. Select (click) the user name you want to delete from the List View.
2. Click the [Delete] button.
3. Click [Yes] when the confirmation message appears.

■ Backing up User Information

1. Click the [Backup] button.
2. Specify the destination and the file name and click the [Save] button when the following screen appears.

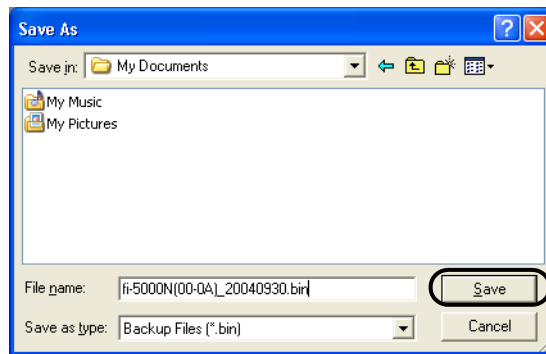

3. The screen to set the backup password for the file to be saved appears. Enter the password up to 16 characters. (To confirm, enter the password again.)



This password is required when you do a restoration. Note that if you forget the password, the backed up files cannot be restored.

4. Click the [OK] button.

⇒The user information is saved to a file.

■ Restoring User Information

1. Click the [Restore] button.
2. Specify the files created at the backup procedure, and click the [Open] button.

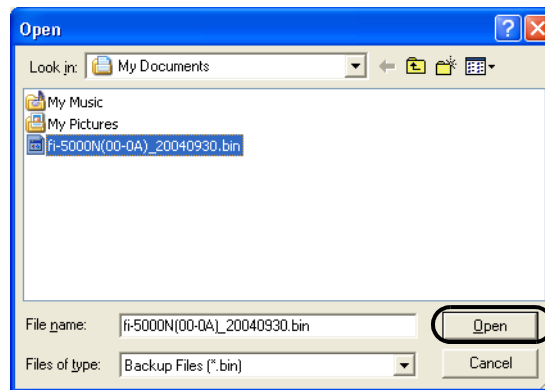

3. The screen for password verification appears.
Enter the password set during backup.



4. Click the [OK] button.
⇒ The user information is restored from the backup file.

5.5 fi-5000N Administrator Settings

The administrator can confirm or change the device information of fi-5000N using the administrator configuration function.

To use this function, the Administrator PIN is required.

■ How to Start

1. Select an fi-5000N from the List View on the main screen on fi-5000N Configuration Tool, and click the [Admin.] button.

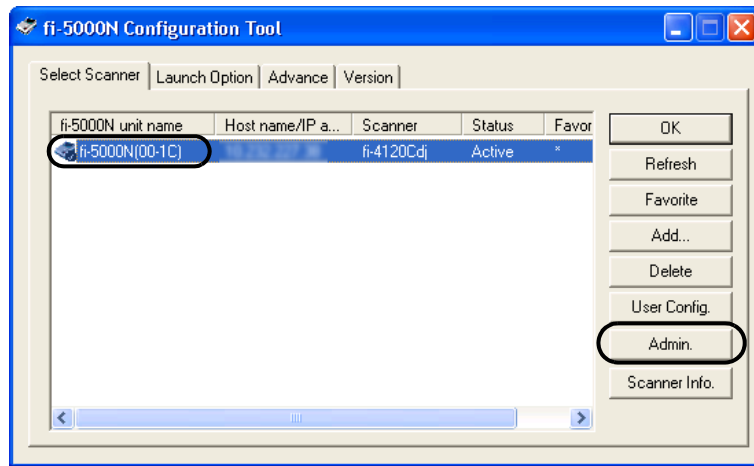

2. The following screen appears. Enter the Administrator PIN, and click the [OK] button.

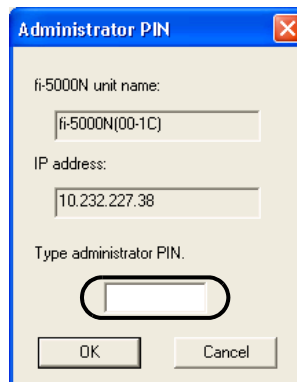

The default Administrator PIN is "5000".

⇒The following screen appears.

The screenshot shows a 'Network Configuration' window. The 'Change fi-5000N configuration' section is checked and contains the following fields: Name (fi-5000N(00-1C)), Firmware version (fi-5000N OE00), IP address (10.232.227.38), Subnet mask (255.255.255.0), Gateway address (10.232.227.1), Primary DNS (10.232.16.12), Secondary DNS (10.232.16.10), Mac address (00-80-17-17-00-1c), and Trigger port (2000-60000) set to 10002. The 'Change PIN' section is also checked and contains 'New PIN' and 'Confirm New PIN' fields. 'Apply' and 'Close' buttons are at the bottom.

The following settings can be configured.

■ Changing the fi-5000N unit name

The currently selected name of fi-5000N is displayed in "Name:"
To change, follow the procedure below.

1. Select the "Change fi-5000N configuration" check box.
2. Enter a name in the edit box.
Enter up to 20 characters.
3. Click the [Apply] button.

■ Changing the Trigger Port on the fi-5000N

The currently selected trigger port number for the fi-5000N is displayed.
To change, follow the procedures below.

1. Select the "Change fi-5000N configuration" check box.
2. Enter a number into the edit box.
Enter a number between 2000 and 60000. The default is 10002.
3. Click the [Apply] button.

■ Changing the Administrator PIN

You can change the PIN of the administrator.
To change, follow the procedure below.

1. Select the "Change PIN:" check box.
2. Enter a new PIN into the edit box.
To confirm, enter the PIN again.
Enter numerals up to 6 digits.
3. Click the [Apply] button.



The administrator PIN is required to use administrator functions of fi-5000N and fi-5000N Software. This PIN can be changed from fi-5000N.

5.6 Managing Scanner Information

With the scanner information management function, you can display the information of the scanner connected to an fi-5000N, reset the consumables counter, configure the power saving mode, and adjust the offset setting.

■ How to Start

Select an fi-5000N from the List View on the main screen on fi-5000N Configuration Tool, and click the [Scanner Info.] button.

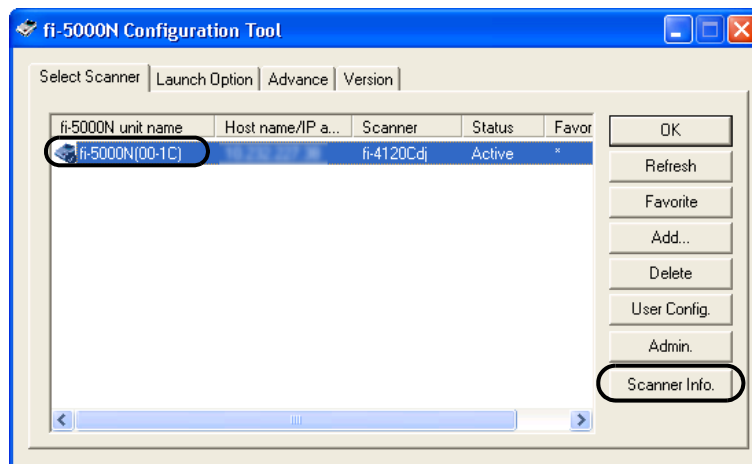

⇒The following screen appears.

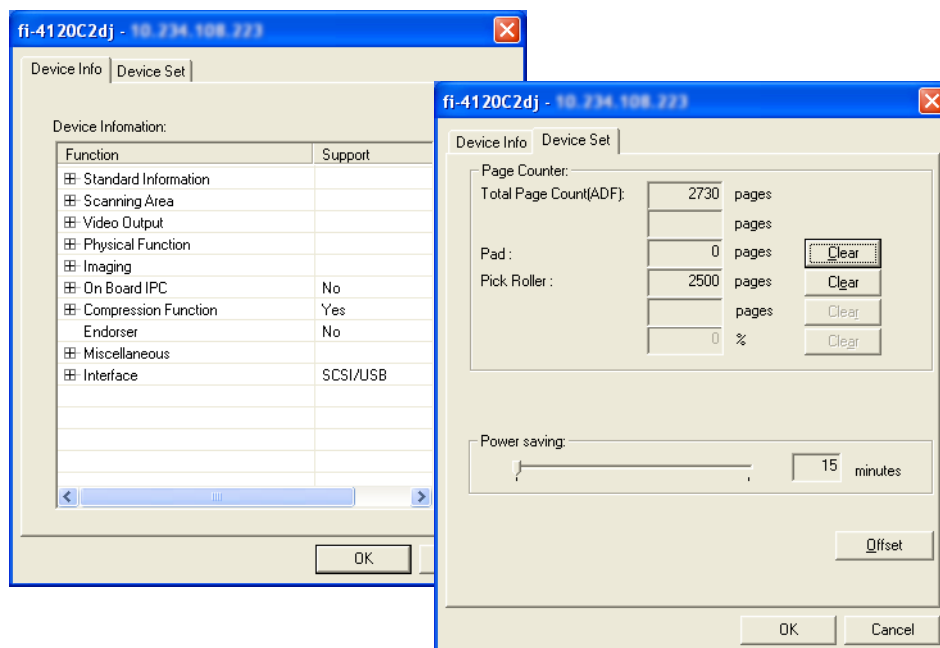

To change the settings at the [Device Set] tab, the Administrator PIN is required.

■ [Device Info] Tab

The list of the scanner functions is displayed in this screen.

The displayed items may differ depending on the scanner.

The displayed items are only the hardware functions, which may not be the same with the values that can be specified during scanning mentioned earlier. The functions that can be achieved by the software are not displayed.

Also, this tab does not appear if the scanner is in use or not connected. If the tab does not appear, exit the application that the scanner is using or check the connection, and then display the tab.

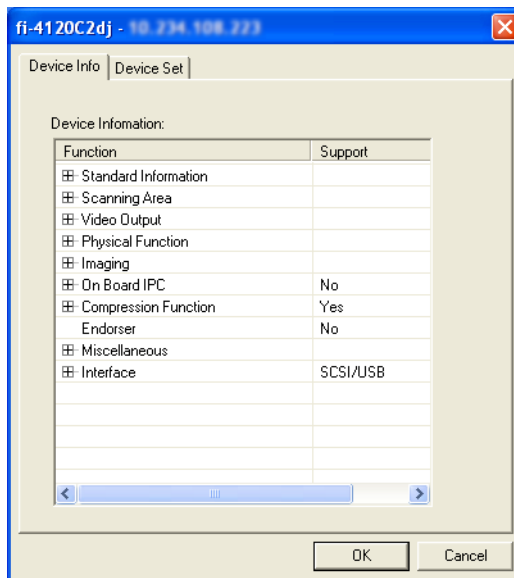

■ [Device Set] Tab

You can display and configure the hardware settings and maintenance information of the scanner. However, there may be items that cannot be displayed or configured (appears dimmed) depending on the scanner.

The changed setting is reflected in the scanner after clicking the [OK] button.

This tab does not appear when the scanner is in use or not connected. If the tab does not appear, exit the application that the scanner is using or check the connection, and then display the tab. (To change the settings, the Administrator PIN is required.)

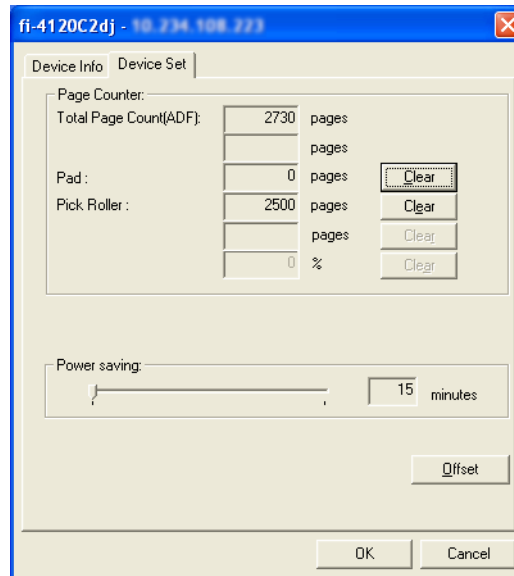

About Replacing Consumables

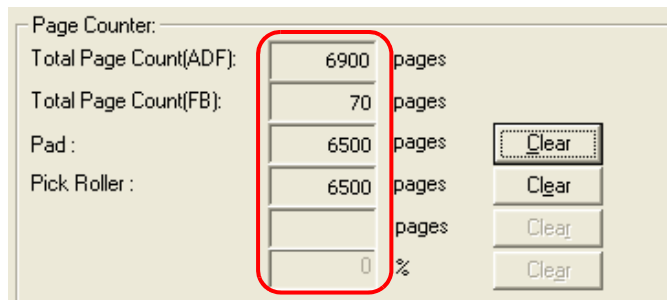

The approximate number of scanned pages since the last consumables replacement and the remaining amount of imprinter ink are displayed in the red frame.

After replacing the consumables, you must click the corresponding [Clear] button to reset the counter.

The consumables differ depending on the scanner. For further details refer to the Operator's Guide supplied with the scanner.

Also, messages such as the following may appear while using the scanner.

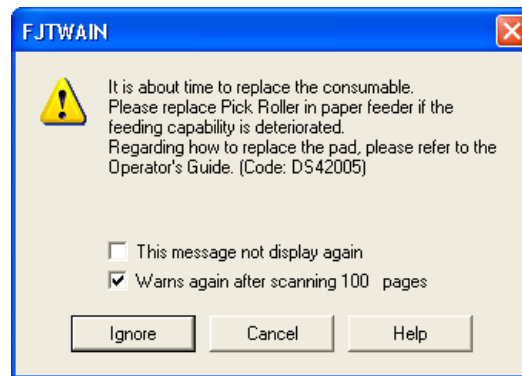

If this message appears, follow the instructions below to replace the consumables.

After clicking the [Ignore] button, this message will disappear and scanning will continue. Please replace the consumable as soon as possible.

This message appears again after certain number of scans. If you do not wish this message to be displayed, select the [This message not display again] check box.

To stop scanning and replace the consumable, click the [Cancel] button.

If the consumables are replaced, reset the consumable counters by clicking the [Clear] buttons located in the [Device Set] tab.

About the Power Saving Settings

Specifies the timer of the lamp to turn off after scanning.

*The timer value range differs depending on the scanner.



About Offset and Scale Adjustment

If you click the [Offset] button, the following window appears.

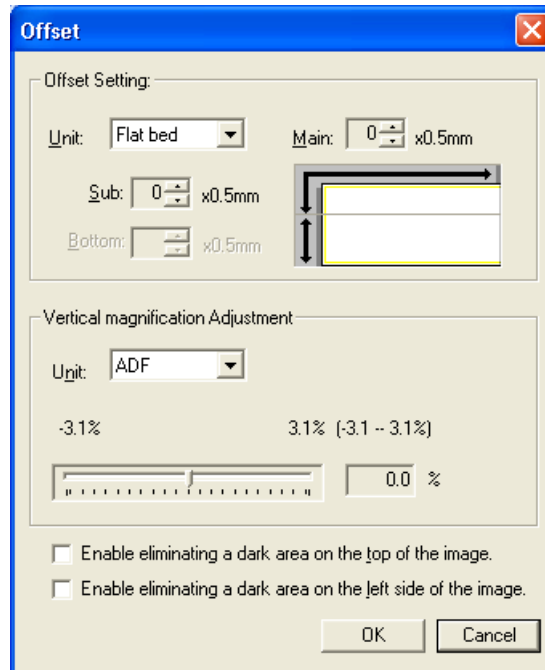

You can change the offset amount of the start position, and the magnification of the sub-scan in this window.

[Offset Setting]

Fine adjustments can be done if the document position is different from the actual scanning position.

Generally, there is no need to adjust the setting as it is adjusted to an optimum value at the factory.

*The setting range differs depending on the scanner.

When using the flatbed, you can specify the following modes to delete shadows on top edge and left edge of the paper.

- "Enable eliminating a dark area on the top of the image" mode
- "Enable eliminating a dark area on the left side of the image" mode

*These modes may not appear depending on the scanner.

[Vertical Magnification Adjustment]

You can change the magnification correction value for sub-scan direction.

In case of ADF, the magnification value for feeding direction can be adjusted based on factory adjustments.

In case of flatbed, the magnification value for the scanning head movement direction can be adjusted based on factory adjustments.

(This function is used when the aspect ratio of the generated image looks different from the scanned document.)

*The adjustable range differs depending on the scanner.

5.7 Settings of [Launch Option]

Set the argument specified in the [Launch Option] tab according to the specifications of the application to be started.

Note that all the examples in this manual assume the usage of [ScandAll 21] bundled with this product.

From the [Launch Option] tab, you can configure the application to start when a button on the scanner ([Scan]/[Send to]) is pressed.

Depending on the setting, the scanner starts scanning automatically, saves the scanned image to file, or displays images on the screen.

"ScandAll 21" is provided with arguments designed for FUJITSU fi-series image scanners. By using "ScandAll 21", you can easily experience a one-touch button operation.

The following arguments are available.

/ScanToFile:	Saves the scanned image to file.
/ScanToView:	Displays the scanned image on the monitor.
/Exit:	Exits the application after scanning. (ScanToFile only)
/PROGRES:0	Hides the FUJITSU TWAIN 32 progressive indicator window.
/SHOWUI:X	Displays or hides the FUJITSU TWAIN 32 setting window. X=0: To hide X=1: To display X=2: Follows the setting done in ScandAll 21
/SCANDEF:XX	Specifies the setting file of FUJITSU TWAIN 32 (XX=00~99).
/NOSCERR	Hides the FUJITSU TWAIN 32 error messages.
/NOAPPERR	Hides the ScandAll 21 error messages.
/AppendToView	Adds the currently scanned image to the previous one to view.
/NOOPDLG	Specifies not to show the following dialog box that can be set from Scan-Option. File setting dialog FTP server setting dialog Print setting dialog Microsoft SharePoint Portal Server setting dialog Mail setting dialog



ATTENTION

You can combine and use these arguments. You have to put a space between each argument. (before slash "/".)

The arguments require no particular order.

However, "/AppendToView" must be used alone because the other arguments will be ignored.

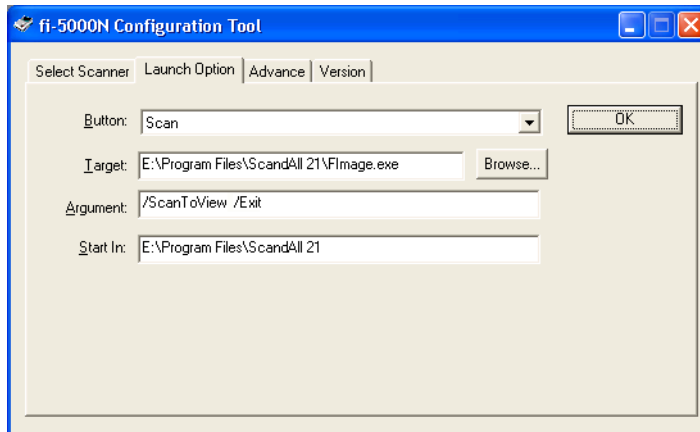

Example 1: When the [Scan] button is pressed, "ScandAll 21" starts up, performs the scanning operation and displays the scanned image.

Name of Item	Setting
Button:	[Scan]
Target:	C:\Program Files\ScandAll 21\FImage.exe (*)
Argument:	/SHOWUI:0_/_ScanToView
Start in:	C:\Program Files\ScandAll 21\ (*)

Example 2: When the [Send to] button is pressed, "ScandAll 21" starts up, performs the scanning operation and saves the scanned images.

Name of Item	Setting
Button:	[Send to 1] (*)
Target:	C:\Program Files\ScandAll 21\FImage.exe (*)
Argument:	/SHOWUI:0_/_ScanToFile
Start in:	C:\Program Files\ScandAll 21\ (*)

* [Target] and [Start in] may differ depending on where "ScandAll 21" is installed. The example above is based on the default setting.

The "_" character which appears in "Argument" indicates a space.

You can assign 9 different functions to the [Send to] button.

By pressing the [Function] button on the scanner's operator panel, the [Send to] button's function can be changed in the following order: [1]→[2]→...[9]→[C]→[1]→...

(Function [C] cannot be used).



The following settings are required on ScandAll 21.

<Start ScandAll 21>

1. From the [Start] menu, select [All Programs] → [Scanner Utility for Microsoft Windows] → [ScandAll 21], and start ScandAll 21.

<Select Scanner>

2. From the menu bar, select [Scan] → [Select Source].
3. Select "FUJITSU" + "Device name" + "on NET...".

<Configuring scanning setting>

4. From the menu bar,
For Example 1, select [Scan] → [To View].
For Example 2, select [Scan] → [To File].
5. For Example 2, configure the file format, destination to save file to, and click the [Scan] button.
6. Configure the scan settings when the "TWAIN Driver" window appears, and click the [Close] button.

<Configuring not-to-display the FUJITSU TWAIN 32 setting screen>

If you do not want to let the FUJITSU TWAIN 32 setting screen appear after pressing the [Scan] or [Send to] button on the scanner's operator panel, follow the steps below.

(*When the argument "SHOWUI:0" is specified, the following steps are not required.)

7. From the menu bar, select [Scan] → [Option...].
8. Clear the "TWAIN Dialog" check box.

<Configuring not-to-display any other setting screen>

If you do not want to let any other ScandAll 21's setting screen appear after pressing the [Scan] or [Send to] button on the scanner's operator panel, follow the steps below. (*When the argument "NOOPDLG" is specified, the following steps are not required.)

9. From the menu bar, select [Scan] → [Option...].
10. From "Other Scan Dialog", clear the check box of the items that you do not want to show.
For Example 2, if you clear the "To File Dialog" check box, you would not have to assign a file name each time a scanning is performed. (Verify that the "Use Counter" check box on the "Scan To File" window is selected.)

*For details on the ScandAll 21 settings, refer to the ScandAll 21 Help.

5.8 Uninstalling the fi-5000N Software

Follow the procedure below to uninstall the fi-5000N Software.

1. Start up your PC.
When using Windows 2000 or Windows XP, log in as a user with "Administrator" rights.
2. Exit all currently running programs.
3. Select [Control Panel] - [Add or Remove Programs] from the [Start] menu.
⇒ This displays the "Add or Remove Programs" screen which displays a list of the currently installed applications.
4. Select "fi-5000N Software".
5. Click the [Change/Remove] button.
⇒ The confirmation window for uninstalling appears.
6. Click the [OK] button.
⇒ This executes the uninstallation.



Screen displays may vary slightly according to the operating system (OS) you are using. Follow the on-screen instructions of the OS.

Example: When the OS is Windows 2000

- "Add or Remove Programs" → "Add/Remove Applications"
- [Change/Remove] button → [Add/Remove] button



Chapter 6



User Authentication

6.1 Fingerprint Registration	70
6.2 User Authentication by Fingerprint	74
6.3 User Authentication by PIN	75
6.4 Changing the User's PIN	76

6.1 Fingerprint Registration

For user authentication, register each user's fingerprint information on this product. However, injured users and users with difficulties in registering fingerprints can be authenticated by using a PIN (personal identification number).

Register users' fingerprints following the procedure below.

1. Open the Cover.

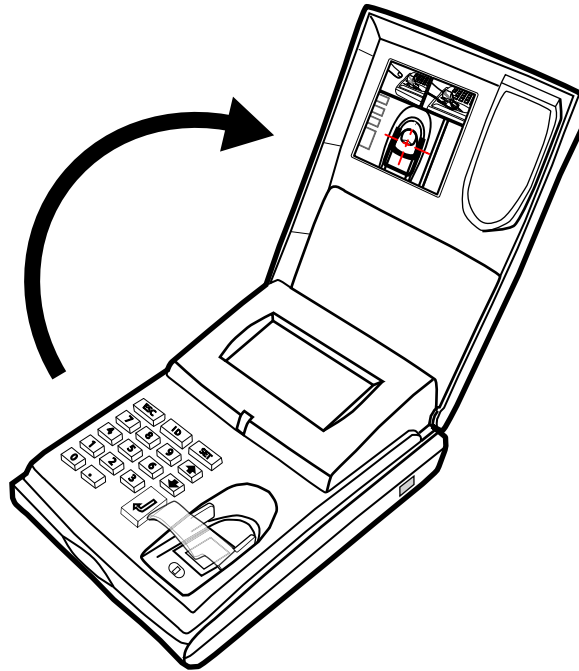

Confirm that the "Place your finger on the sensor" (this indicates the "Logout" status) is displayed on the fi-5000N Message Display.

```
Place your finger  
on the sensor
```

2. Then press the [SET] key on the fi-5000N's keyboard.

The following screen appears.

```
Setup  
Register Finger  
Change PIN Code  
Show Network Config
```

3. Select "Register Finger", and press the [ENT] key.

The list of registered users on fi-5000N appears.

```
Select User  
1 (user's name)  
2 (user's name)  
3 (user's name)
```



The fi-5000N's Administrator must register the user in advance. The user name registered by the Administrator in the fi-5000N Software will be displayed. For details, refer to "5.4 Managing User Information of fi-5000N" (page 52)



- 4. Press the [↑] or [↓] key to select a user from the list of registered users, and press the [ENT] key.



You can also select the registered user by entering user ID number:

1. With the keyboard, enter the user ID number.
2. Press the [ENT] key.
⇒ The name of the user to log in will appear selected.
3. Press the [ENT] key again.



The screen to enter the user's PIN (personal identification number) appears.

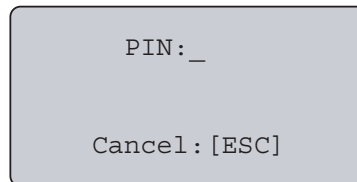

- 5. Enter the user's PIN and press the [ENT] key.

If the PIN does not match, the message "The PIN is incorrect" is displayed, and you are prompted to enter again.

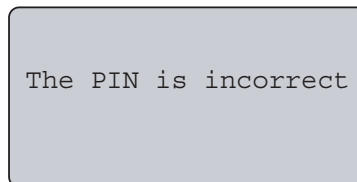

If your fingerprint is already registered, the message "Your finger is already registered. Register again?" is displayed. Press the [ENT] key to re-register your fingerprint, otherwise press the [ESC] key.

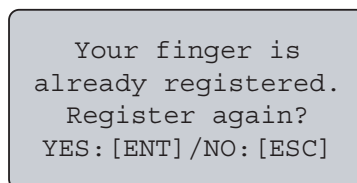

- The Administrator sets the initial user's PIN during the user registration. For details, refer to "5.4 Managing User Information of fi-5000N" (page 52).
- The user is able to change his/her own PIN. For details, refer to "6.4 Changing the User's PIN" (page 76).



If the PIN matches, the following screen appears.
Confirm the correct finger placement by looking at the sticker inside of the cover. For the details, please refer to "APPENDIX Using User Authentication by Fingerprint."

Look at the sticker
inside of cover for
finger placement
OK: [ENT]

Press [ENT] key, then the following screen appears and the registration of the fingerprint starts.

Registration:
Place your finger
on the sensor

6. Place the finger to register on the fingerprint sensor.

If your fingerprint is correctly captured, a buzzer sounds and at the same time the following screen appears.

Processing...
Remove your finger
from the sensor

7. Remove your finger from the fingerprint sensor.

The following screen appears and the fingerprint verifications will be repeated twice.

Fingerprint will
be verified twice.
Place your finger
on the sensor

8. For verification procedure, place the registered finger on the fingerprint sensor again.

If the first verification is successfully done, the following screen appears.

First Verification
is successful

9. Second verification starts.

Starting Second
Verification.
Place your finger
on the sensor

10. When the 2nd verification process has been completed, the following message appears.

```
Second Verification  
is successful
```

Then the message indicating that the fingerprint data is being saved is displayed.

```
Saving fingerprint  
data...
```

Next, the finishing registration message appears.

```
Registration is  
successful  
OK: [ENT]
```

Press [ENT] key to finish the registration.



6.2 User Authentication by Fingerprint

To change from the logout status to the status when the scanner can start scanning (login), fingerprint authentication must be done. (Also, PIN authentication is equipped as an alternative to an injured users or users with difficulties in fingerprint authentication.)

1. When "Place your finger on the sensor" is displayed on the fi-5000N Message Display (this indicates the "Logout" status), place on the fingerprint sensor the finger that has been registered.

Place your finger
on the sensor



When you learn to place the finger correctly, you can remove the Finger Guide. For the removal, refer to "APPENDIX Using User Authentication by Fingerprint."

When the finger placed on the fingerprint sensor is detected, the following message appears and the fingerprint capturing begins.

Capturing
fingerprint...

2. If the capturing of your fingerprint is successfully done, a buzzer sounds and at the same time the following screen appears. Remove your finger from the fingerprint sensor.

Identifying...

Remove your finger
from the sensor

3. Next, the identification of your fingerprint begins.

If the identification of your finger is successfully done, a buzzer sounds and at the same time the following login screen appears.

Load the document on to ADF and press [Scan] or [Send to] button on the scanner.

(user's name)
Load the documents
onto scanner & press
[Scan] / [Send to]

6.3 User Authentication by PIN

PIN authentication is equipped as an alternative to injured users or users with difficulties in fingerprint authentication.

1. When "Place your finger on the sensor" is displayed on the fi-5000N Message Display (this indicates the "Logout" status), open the cover and press the [ID] key.

The "Select User" screen appears as follows.

```
Select User
1 (user's name)
2 (user's name)
3 (user's name)
```

2. Select the registered user with the [↑], [↓] keys, and press the [ENT] key.

 You can also select the registered user by entering user ID number:

1. With the keyboard, enter the user ID number.
2. Press the [ENT] key.
⇒ The name of the user to log in will appear selected.
3. Press the [ENT] key again.

The next screen appears, and the PIN is prompted.

```
PIN: _
Cancel: [ESC]
```

3. Enter the user's PIN, and press the [ENT] key.

If the PIN does not match, the message "The PIN is incorrect" appears, and you are prompted to enter again.

4. If the PIN matches, the login screen appears.

```
(user's name)
Load the documents
onto scanner & press
[Scan] / [Send to]
```

6.4 Changing the User's PIN

The initial user's PIN value is set by the Administrator during the user registration. However the user is able to change his/her own PIN.

Change the user's PIN following the procedure below.

1. When "Place your finger on the sensor" is displayed on the fi-5000N Message Display (this indicates the "Logout" status), open the cover and press the [SET] key.

The following settings screen appears.

```
Setup
Register Finger
Change PIN Code
Show Network Config
```

2. With the [↓] key, select "Change PIN Code", and press the [ENT] key.

The "Select User" screen appears as follows.

```
Select User
1 (user's name)
2 (user's name)
3 (user's name)
```

3. Select the registered user with the [↑], [↓] keys, and press the [ENT] key.

The next screen appears, and the PIN is prompted.

```
Current PIN:
_
Cancel: [ESC]
```

4. Enter the current PIN and press the [ENT] key.

If the PIN does not match, the message "The PIN is incorrect" appears and you are prompted to enter again. If the PIN matches, the message "New PIN:" appears.

```
New PIN:
_
Cancel: [ESC]
```

5. Enter the new PIN and press the [ENT] key.

For confirmation, re-enter the PIN again.

If the registration of the new PIN is successfully done, the following screen appears.

```
PIN has been
changed
```

With this, the user's PIN is changed.

Chapter 7



Daily Care

This chapter describes how to clean the fi-5000N.



Before you clean the fi-5000N, turn off its power and unplug the AC adapter from the outlet.

7.1 Cleaning Materials.....	78
7.2 Parts to Clean and Cleaning Method.....	79

7.1 Cleaning Materials

Cleaning Materials	Parts Number	Remarks
Cleaner F1	PA03950-0352 (*1)	1 bottle Moisten the cloth with this fluid and wipe the scanner clean.(*2) Do not use it for cleaning printed characters, logos and marking areas.
Lint-free dry cloth	Commercially available	

- *1) It may take long before the cleaner vaporizes if a large quantity is used. When cleaning the scanner parts, dampen a cloth with modest quantities of the cleaner. In addition, wipe off the cleaner completely with a soft lint-free cloth to leave no residue on the surface of the cleaned parts.
- *2) For details about the cleaner F1, contact the FUJITSU dealer where you purchased the fi-5000N.

7.2 Parts to Clean and Cleaning Method

Part to clean	Cleaning Method	Remarks
Cover	Wipe the Cover with a lint-free dry cloth.	
Fingerprint Sensor	Wipe the Fingerprint Sensor gently with a dry lint-free cloth.	Do not splash any liquids or allow the fi-5000N to get wet. Do not use flammable solvents such as benzine.



Cleaning the Fingerprint Sensor

The sensor might not function correctly in the following situations. Clean the sensor surface on a regular basis.

- Sensor surface is dirty with dust or any other dirt
- Sensor surface is wet.
- There are dew drops on the sensor surface.

Clean the fingerprint sensor when the following problems occurs. Cleaning the sensor might solve such problems.

- The Display Message shows "Sensor surface not clean. Please wipe sensor, and restart device".
- Although the finger is away from the sensor, the Display Message keeps showing "Remove your finger from the sensor".
- Fingerprint registration failures and/or fingerprint identification failures occur frequently.



Chapter 8



Troubleshooting



8.1 Error Messages and Remedies	82
8.2 Troubleshooting	88
8.3 Items to Check Before Asking for Repair	90
8.4 Checking Labels on the fi-5000N	91

8.1 Error Messages and Remedies

If an error occurs in fi-5000N, a temporary error or device alarm message will appear on the Message Display.

Temporary errors are errors that can be resolved by the user, while device alarms are malfunctions errors that require recovery work by support engineers.

■ Temporary Errors

If the same message still appears after following the contents listed below, contact the store where you purchased the scanner or an authorized FUJITSU scanner service provider.

Message	Remedies
Sensor surface not clean. Please wipe sensor, and restart device.	The fingerprint sensor surface is dirty. Turn off the power, wipe the surface lightly with a dry lint-free cloth.
Scanner is disconnected	Check the following: <ul style="list-style-type: none">• Is the scanner turned on?• Is the USB cable connected to the scanner?• Is the USB cable damaged?
Unsupported device is connected	Check that the connected scanner is any one of the fi series. For information about the supported scanners, see "9.1 Basic Specifications".
The network cable is disconnected	Check the following: <ul style="list-style-type: none">• Is the network cable (LAN) connected to the network?• Is the network cable (LAN) connected to this device?• Is the network cable (LAN) connected to a hub (router, etc.)?• Is the hub turned on?• Is the network cable (LAN) damaged?• Is the correct network cable being used? (Correct: straight cable; incorrect: cross cable)
The IP address is already in use by another device	It is possible that the IP address is already in use by another device. Consult with the network administrator and change any one of the IP addresses.

Message	Remedies
Position your finger a little lower	Check the following: Did you placed your finger in the correct position on the sensor? * Refer to "APPENDIX Using User Authentication by Fingerprint" (page 1).
Position your finger a little higher	
Position your finger a little more right	
Position your finger a little more left	
Unable to capture fingerprint. Place finger on sensor correctly	<ul style="list-style-type: none"> • Verify that you are placing your finger in the correct position. Refer to "APPENDIX Using User Authentication by Fingerprint" (page 1) • During fingerprint registration, do not remove your finger until the beep sounds.
Capturing failure Your finger is wet. Please wipe finger and sensor.	Your fingerprint cannot be captured as your finger is wet. Clean your registered finger. Also, moisten a cloth with Cleaner F1 and wipe the sensor's surface lightly.
User is not registered.	Place the finger that is registered on the sensor. (This message disappears after 3 seconds and the device returns to logout status)
Invalid ID number	Check your ID number, and enter the correct ID number.
The PIN is incorrect	Check your PIN, and enter the correct PIN.
The New PIN entries do not match	Check whether the PIN is incorrect.
This fingerprint is not registered.	Do the following: <ul style="list-style-type: none"> • Change your finger position on the fingerprint sensor. • Check with the PIN whether you are a registered user. • Check whether it is a different finger that has been registered. • Register your finger again.
Unable to register fingerprint. Please register again.	Refer to "APPENDIX Using User Authentication by Fingerprint" (page 1) and register your fingerprint again.
Unable to register this finger. Register different finger.	The finger may not be in optimal condition (extremely dry skin, wounded, etc.) for registration. Register another finger.
Failed to save fingerprint data	Register your fingerprint again. If the problem persists, turn off and on the power, and configure the fingerprint settings again.
Invalid IP address	Check whether the IP address entered is incorrect.
Invalid subnet mask	Check whether the subnet mask entered is incorrect.
Invalid gateway address	Check whether the gateway address entered is incorrect.
Invalid DNS server address	Check whether the DNS entered is incorrect.



Message	Remedies
Host connection failure due to time-out	Check the following: <ul style="list-style-type: none"> • fi-5000N is connected via network to the PC specified by the logged-in user. • The PC specified by the logged-in user is running. • fi-5000N Software is installed on the PC specified by the logged-in user. • If Windows XP Service Pack 2 or later is installed in your computer, check if "fi-5000N Event Module" is added to [Programs and Services:] on the [Exceptions] tab of [Windows Firewall] and its checkbox is marked. If "fi-5000N Event Module" is not present, log off the computer once and log in as the user with "Administrator" authority again to unblock this module. • The trigger port settings for fi-5000N and the settings for the PC specified by the logged-in user are identical.
Host busy with other fi-5000N. Wait few minutes and try sending again.	The host computer is performing a scanning operation with other fi-5000N. Wait until this operation is finished and try scanning again.
DNS server is not configured	Set the DNS server in "Configure Network".
Cannot access DNS server	In "Configure Network", check whether the DNS server is set correctly.
Name resolution failure	The destination host name configured by the logged in cannot be converted into an IP address. Check whether the host name settings are correct.
Failed to start Application	At [Launch Option] tab in the "fi-5000N Configuration Tool" dialog box, verify that "Target" is set correctly.
Cannot obtain IP address from DHCP server.	Consult with the network administrator whether the DHCP server is working properly. If the DHCP server is not working properly, configure the settings of the fixed IP address.
Document jam	Document jam occurred during scanning operation. Correct the jammed conditions. Press [ENT] key on fi-5000N keyboard. If the PC which is to receive the scanned data is showing an error message, follow the instructions.
ADF cover opened	Scanner ADF paper chute, hopper or imprinter cover is opened. Confirm that scanner ADF paper chute, hopper and imprinter are closed completely. Press [ENT] key on fi-5000N keyboard. If the PC which is to receive the scanned data is showing an error message, follow the instructions.

Message	Remedies
No paper on ADF paper chute	<p>Scanner's ADF paper chute or the hopper has no document on it.</p> <p>Confirm that document are loaded correctly on the ADF paper chute or on the hopper.</p> <p>Press [ENT] key on fi-5000N keyboard.</p> <p>If the PC which is to receive the scanned data is showing an error message, follow the instructions.</p>
Multifeed error	<p>Multifeed occurred during scanning operation. Remove the document in the scanner's document feeding path and correct the multifeed conditions.</p> <p>Press [ENT] key on fi-5000N keyboard.</p> <p>If the PC which is to receive the scanned data is showing an error message, follow the instructions.</p>
Shipping lock malfunction	<p>Confirm that the shipping lock is in released position.</p> <p>Press [ENT] key on fi-5000N keyboard.</p> <p>If the PC which is to receive the scanned data is showing an error message, follow the instructions.</p>
No print cartridge	<p>Confirm if the imprinter's print cartridge is installed correctly and the connection parts are clean and not contaminated.</p> <p>Press [ENT] key on fi-5000N keyboard.</p> <p>If the PC which is to receive the scanned data is showing an error message, follow the instructions.</p>

For the remedies to solve scanner related temporary errors, refer to troubleshooting section on "FUJITSU TWAIN 32 User's Guide" in the Setup CD-ROM included in the scanner.



■ fi-5000N Device Alarms

If one of the following messages are shown on fi-5000N Message display, it is likely that fi-5000N has hardware problem. In this case, turn off the fi-5000N power and turn it on again. If the same device alarm occurs, contact the store where you purchased fi-5000N or an authorized FUJITSU scanner service provider.

Message	LED	Buzzer frequency
(Nothing is displayed)	Blinks at 1 second intervals	-
(Nothing is displayed)	Blinks at 2 seconds intervals	-
Memory Error Restart the device	-	-
Failure of loading program. Restart the device.	-	-
PCI Initial Error. Restart the device.	-	Once (long)
MACROM Read Error Restart the device	-	Once (long)
Hardware error of fingerprint sensor. Restart the device.	-	Once (long)
Failure of fingerprint sensor initialization. Restart the device.	-	Once (long)
Calibration of fingerprint sensor failed. Restart the device.	-	Twice
Network configuration failure. Restart the device.	-	Twice

■ Scanner Device Alarms

If one of the following messages are shown on fi-5000N Message display, it is likely that the scanner has hardware problem. In this case, turn off the scanner and fi-5000N power and turn them on again. If the same device alarm occurs, contact the store where you purchased the scanner or an authorized FUJITSU scanner service provider.

No.	Message	No	Message
1	Temporary shortage of scanned data	12	LSI malfunction
2	EEPROM Error	13	Heater malfunction (ADF Front)
3	Fuse for ADF motor blown	14	Heater malfunction (ADF Back)
4	Background changeover unit failure	15	Heater malfunction (Flatbed)
5	Optical error	16	Motor fuse malfunction
6	Imprinter error	17	Lamp fuse malfunction
7	Fuse for Imprinter blown	18	Optical error (ADF Front)
8	Flatbed motor malfunction	19	Optical error (ADF Back)
9	Memory malfunction	20	Optical error (Flatbed)
10	Sensor malfunction	21	Fan malfunction
11	Internal communication error of the scanner	22	Option board malfunction



8.2 Troubleshooting

Before you ask for repair service, check the following first.

If you cannot solve the problem even after checking the following items, contact the store where you purchased the fi-5000N, or contact an authorized FUJITSU scanner service provider.

Symptom	Check this item	Remedy
fi-5000N cannot be turned on. (Power lamp (LED) is not lighted)	Is the power switch turned on?	Turn on the power switch.
	Are the AC adapter and the power cable of fi-5000N connected correctly?	Re-connect the AC adapter and the power cable correctly.
	Turn off the power, and disconnect the USB cable. Is the power restored when you turn on the power again?	Check whether there is a problem with the USB cable or the power cable.
	Turn off the power, and disconnect the network cable. Is the power restored when you turn on the power again?	Check whether there is a problem with the network cable or the network (such as hub, router).
	The power lamp (LED) could be damaged If any of the following is observed: Is the lamp on the network connector blinking (orange)? Do messages appear on the Message Display? Can the problematic fi-5000N be seen from the fi-5000N software?	Turn on the power again.
Nothing is displayed on the Message Display	Is the power lamp of fi-5000N lighted up?	Turn off the power switch. Check that the AC adapter and the power cable are connected, and then turn on the power.
	Turn off the power of fi-5000N, and disconnect the USB cable. Does the problem prevail even after you turn on the power again?	Check whether there is a problem with the USB cable or the power cable.
	Turn off the power of fi-5000N, and disconnect the network cable. Does the problem persist even after you turn on the power again?	Check whether there is a problem with the network cable or the network (such as hub, router).
The fi-5000N's keyboard does not respond when the keys are pressed	Are the power lamp of fi-5000N lighted, and messages displayed on the Message Display?	Turn off the power switch. Check that the AC adapter and the power cable are connected, and then turn on the power.



Symptom	Check this item	Remedy
Scanning does not start when the [Scan] or [Send to] button is pressed.	Is the scanner showing an error code? (Does "U" or "E" appear on the Function Number display of the scanner?)	Note down the displayed message, and take the appropriate action subject to the displayed message.
	Does any error message appear on the fi-5000N?	Take the appropriate action subject to the displayed message.
	Turn off the fi-5000N and reconnect the USB cable. Does the problem persist even after you turn on the power again?	Check whether there is a problem with the USB cable or the scanner.
	Turn off the fi-5000N and reconnect the network cable. Does the problem persist even after you turn on the power again?.	Check whether there is a problem with the network cable or the network (such as hub, router).
Fi-5000N does not appear on the [Select Scanner] tab of the fi-5000N Configuration Tool. (Unable to communicate over the network)	<ol style="list-style-type: none"> 1. Is the network cable connected? 2. Is the Hub turned on? 3. Is the fi-5000N's IP address set correctly? 4. Is the fi-5000N turned on? 	Check whether there is a problem with the network cable or the network (such as hub, router).
A message informing that scanner is not found appears during scanning.	Is the fi-5000N added to [Favorite] on the [Select Scanner] tab of the fi-5000N Configuration Tool?	Add the fi-5000N you want to use to [Favorite].
	Isn't the status of the fi-5000N "Inactive" on the [Select Scanner] tab of fi-5000N Configuration Tool after it is added to [Favorite]?	Check if your using fi-5000N is turned on and the network is online.
	Isn't the indication of the Scanner to be connected to the fi-5000N is "-----" on the [Select Scanner] tab of the fi-5000N Configuration Tool?	Check if your using fi-5000N is connected to the scanner and the scanner is turned on.
	Isn't the status of the fi-5000N "Busy" on the [Select Scanner] tab of fi-5000N Configuration Tool?	The fi-5000N is being used by another user. Wait until it becomes available. Then, update the displayed [Select Scanner] tab, check that the status of fi-5000N is "Active", and scan the document again.
I am identified as a different user to log in by fingerprint authentication.	Is the fingerprint unique to the user? Aren't multiple users registered using the same fingerprint?	Every user must be registered using the unique fingerprint.

8.3 Items to Check Before Asking for Repair

Collect the following information before you contact the dealer where you bought the scanner or an authorized FUJITSU scanner service provider.

Item to check	Example	Remarks
Model	fi-5000N	For details on the model name refer to "8.4 Checking Labels on the fi-5000N" (page 91)".
Serial number	000001	For details on the serial number refer to "8.4 Checking Labels on the fi-5000N" (page 91)".
Production date	2004-12 (December, 2004)	For details on production date refer to "8.4 Checking Labels on the fi-5000N" (page 91)".
Firmware version	0700	For details on how to check the firmware version, refer to "3.10 Displaying Device Information" (page 25)
Date of purchase	2004/12/11	
Symptoms	There is no response when pressing the [SET] button.	Explain the symptom as much as possible.
Frequency of malfunction	Once a week	
Type of OS (Windows®)	Windows XP (with SP2)	
Connected Scanner Information: Model Serial Number Production date Date of purchase	fi-4220C2 00001 2004-11 (November, 2004) 2004-12 (December, 2004)	For details of the scanner information, refer to the Operator's Guide of the connected scanner.
Scanner driver name and version	FUJITSU TWAIN 32 V 9.16.5	
Scanning Application name and version	ScandAll 21, V4.2.31	

8.4 Checking Labels on the fi-5000N

The following illustrations are samples of the product labels of the fi-5000N.

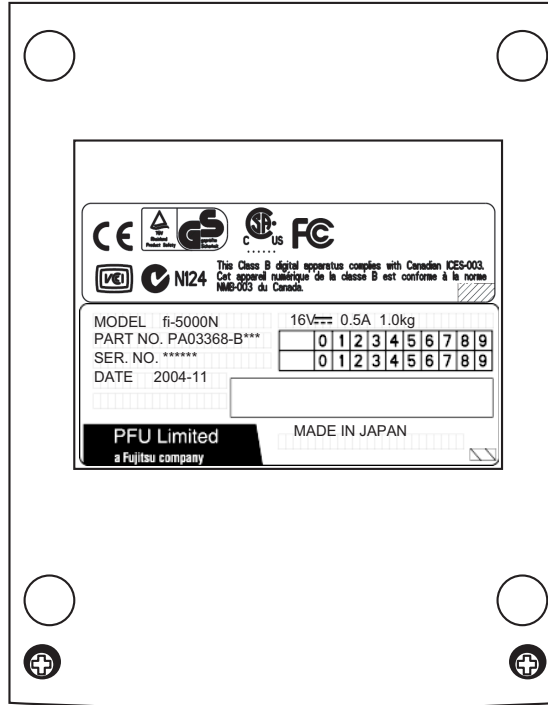

Label A (Example): Compliance of the device with specifications is shown.



Label B (Example): Information on the device is shown.

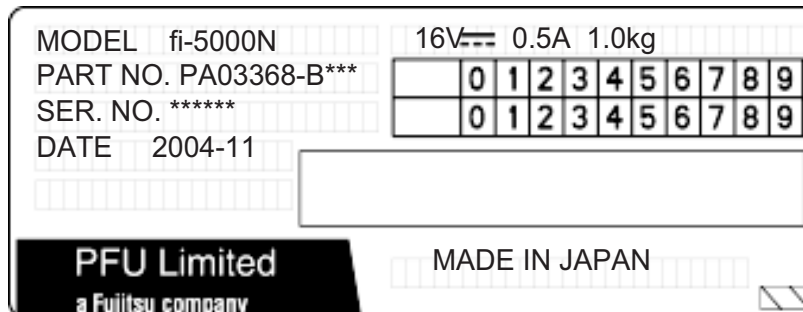

Chapter 9



Specifications

This chapter lists the fi-5000N specifications.

9.1 Basic Specifications	94
9.2 Installation Specifications	95
9.3 External Dimensions	96
9.4 fi-5000N Software Specifications	97

9.1 Basic Specifications

Item		Specification
Message Display	Type	Monochrome with backlight (LCD display)
	Panel size	20 characters × 4 lines
	Language	English, German, French, Italian, Spanish, Japanese
Keyboard		[ID], [SET], [ESC], [ENT←], [↓], [↑], [·], Numeric key (0~9) Total: 17 keys
Fingerprint Sensor		Static capacity method Resolution: 500 dpi (256 × 300 pixels)
Finger (Detection) Sensor		Type: Infrared light photo-reflector
Memory	Flash ROM	2 MB
	RAM	32 MB
Scanner Interface		USB 2.0 / 1.1 compatible (USB 2.0/1.1 Auto-recognition)
Supported scanners		fi-5110C, fi-5120C, fi-5220C, fi-5530C, fi-4120C2, fi-4220C2, fi-4120C, fi-4220C, fi-4530C (as of December 2005) For the latest information about the supported scanners, visit our website.
Network Interface		LAN IEEE802.3 (10BASE-T) IEEE802.3u (100BASE-TX)

9.2 Installation Specifications

Item		Specification		
Dimensions		Depth	Width	Height
		176 mm (6.93 in)	125 mm (4.92 in)	62 mm (2.44 in)
Weight		1.0kg (2.2lb)		
Input power	Voltage	100 to 120 VAC \pm 10%		
	Phases	Single-phase		
	Frequency	50 / 60 \pm 3Hz		
Power consumption		8 W or less		

Item		Specification	
Ambient condition	Device status	Operating	Not operating
	Temperature	5 to 35° C (41 to 95° F)	-20 to 60° C (-4 to 140° F)
	Humidity	20 to 80 %	8 to 95 %

9.3 External Dimensions

The following shows the external dimensions of the fi-5000N:

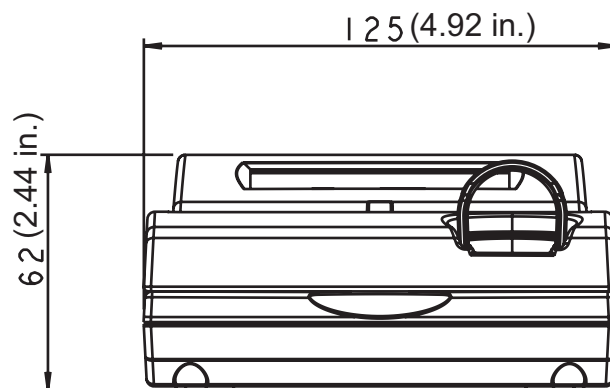
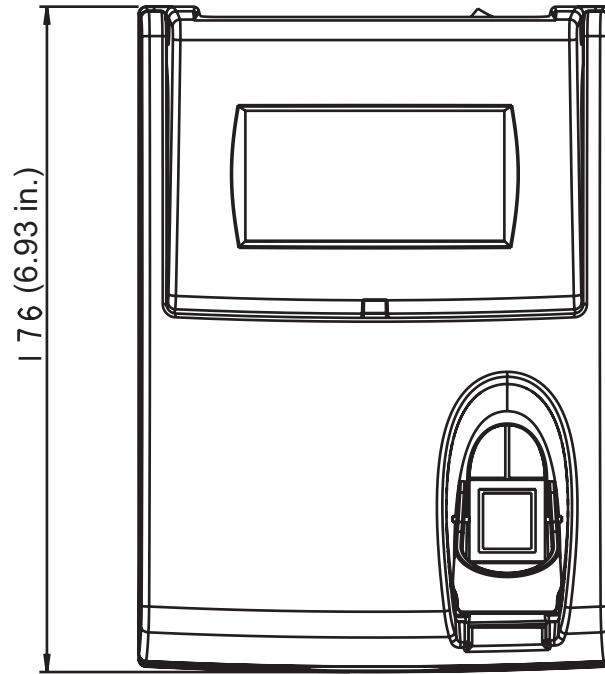

(Unit: mm)

9.4 fi-5000N Software Specifications

Software specifications for the fi-5000N are listed as below.

Item	Specification
Number of scanners that can be connected	32 or less
Number of registered users	Up to 32 users
Trigger port	10002 (2000 to 60000)

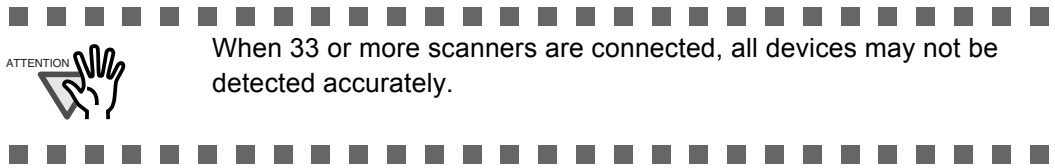

APPENDIX Using User Authentication by Fingerprint

■ How to place your finger on the sensor

Pay attention to the following points when performing fingerprint registration or authentication.

- For reliability, align your finger such that the virtual line connecting the white positioning marks on the both sides of the fingerprint sensor crosses the base of your fingernail, and press your finger to the sensor.
[To confirm the correct way to place your finger, click here to view the movie.](#)
- Make sure your finger covers the finger (detection) sensor. (Do not let your finger float away from the sensor.)
[To confirm the correct way to place your finger, click here to view the movie.](#)

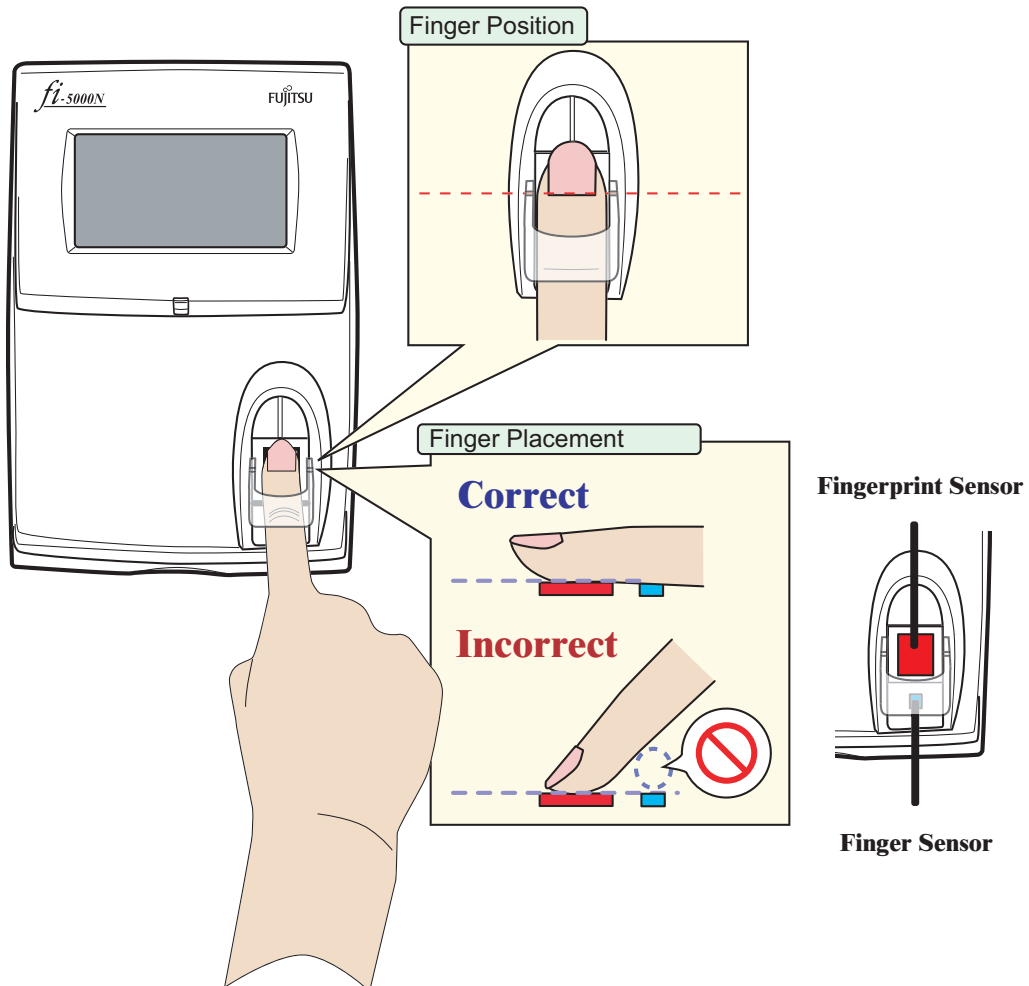

A



The following finger conditions may cause a registration or authentication failure.

- The skin of finger gets rough or is extremely dry.
- The finger surface is wounded or has suffered an abrasion so that the fingerprint mark becomes thin.
- The fingerprint has been changed due to a rapid gain or loss of weight.

Washing, wiping, or using a different finger may improve the situation.

■ Caution on fingerprint sensor usage

- Discharge static electricity from your finger by touching a metallic object before placing your finger on the sensor. Static electricity may cause a sensor failure. This procedure is particularly important in dry winter season.
- Do not scratch, or pick at the sensor with a sharp-pointed item. This can damage the sensor.
- Do not rub the surface with your fingernail or hard item. This can damage the surface and lead to failure.
- Do not touch the surface with a muddy or dirty finger which may damage, or contaminate the surface leading to failure.
- Do not put a sticker on the sensor or paint its surface. This can lead to failure.
- The following may cause difficulties in capturing fingerprints. Clean the sensor on a regular basis.
 - Sensor surface is dirty with dust or fat content from finger.
 - Sensor surface is moist with perspiration
 - Sensor surface is moist with dew condensation
- If the following problems occur, clean the sensor surface. The situation may improve.
 - "Processing... Remove your finger from the sensor" message keeps appearing.
 - Registration or authentication failures occur frequently.
- When cleaning the sensor, use a dry lint-free cloth and wipe it gently.

■ Removing Finger Guide

For the ease of fingerprint registration by letting you place your finger correctly, the Finger Guide is installed on the fi-5000N fingerprint sensor area. When you get accustomed to placing the finger correctly on the fingerprint sensor, you can remove the Finger Guide. To remove the Finger Guide, follow the instructions below.

- 1) Hold both sides of the Finger Guide.
- 2) Squeeze the guide lightly to detach its pins.
- 3) Lift the guide up and remove it from the fi-5000N.

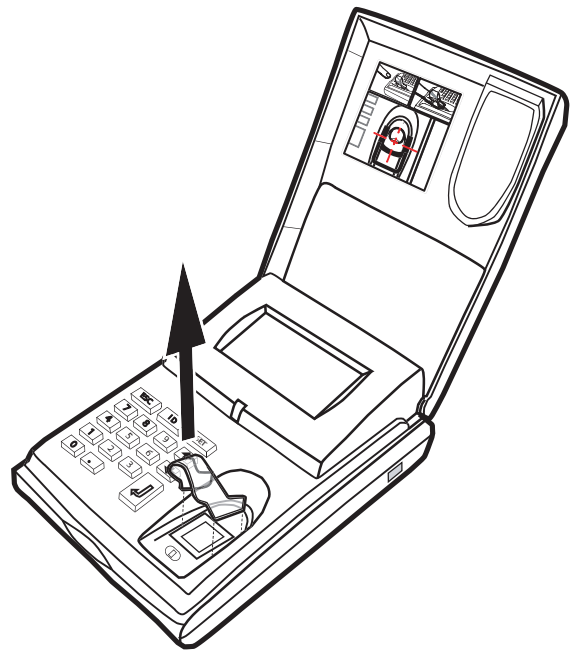
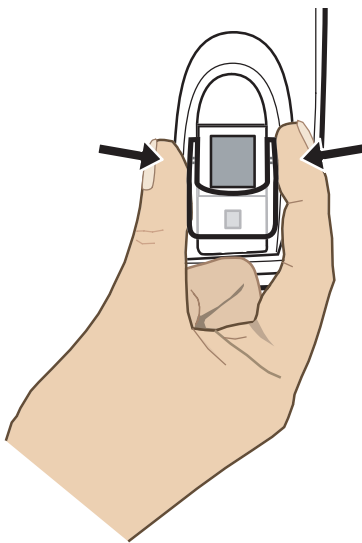

A



INDEX



A

AC adapter	12
AC cable	12
Add button	45
Adding fi-5000N	49
Admin. button	46
Administrator	5
Administrator Settings	57
Advance Tab	48
Ambient condition	95
Application	36
Argument	47
Arguments	65
Authentication by Fingerprint	74

B

Backing up	
User Information	55
Backlight Off Settings	19
Beep Sound Configuration	20
Button	47

C

Changing	
Administrator PIN	59
User Information	54
User PIN	54
Changing Language Setting	18
Cleaner F1	78
Cleaning Materials	78
Configuring Application	

FUJITSU ISIS	37
FUJITSU TWAIN32	36
Connecting to the Network	14
Cover	8

D

DC Inlet	9
Delete button	46
Deleting	
fi-5000N	51
Users	55
Device Info Tab	61
Device Setting Tab	62
DHCP	15
Displaying Network settings	25

E

ENT Key	10
ESC Key	10
External dimensions	95, 96

F

Favorite button	45
fi-5000N Software Specifications	97
Finger Guide	8
Finger Sensor	8
Fingerprint Sensor	8
Firmware version	25
FUJITSU ISIS	27
FUJITSU TWAIN	27

H	
Host Connection Time-out	24

I	
ID key	10
Initialization of fi-5000N	26
Input power	95
Installing	
fi-5000N Software	42
FUJITSU TWAIN 32	28
ScandAll 21	31
Installing the fi-5000N	12

K	
Keyboard	8, 10

L	
Language for Message Display	18
Launch Options Tab	47
LED	8

M	
Magnification Adjustment	64
Message Display	8

N	
Network Connector	9
Network name of fi-5000N	25

O	
Offset	64
Operator	5

P	
PIN	15
Power consumption	95

Power Saving Settings	63
Power Switch	9
Pull mode	4, 21
Pull mode user authentication	21
Push mode	4, 21
Push Mode Automatic Logout Time	23

Q	
QuickScan Pro	27

R	
Refresh button	45
Registering Users	53
Replacing Consumables	62
Reset to Factory default	26
Restoring	
User Information	56

S	
ScandAll 21	27
Scanner Drivers	27
Scanner Info. button	46
Scanner Information	60
Security	8
Show Scanner Info.	25
Specifications	93
Ambient condition	95
Dimensions	95
Input power	95
Power consumption	95
Weight	95
Start in folder	47
Static IP	15

T

Trigger port	48
Turn on the power	14

U

Uninstalling	
fi-5000N Software	68
the Scanner Driver and Scanning	
Application	39
USB cable	13
USB Connector	9
User Authentication by PIN	75
User Config. button	46, 52

V

Version Tab	48
-------------------	----

W

Waiting time for the host's connection	24
Weight	95

fi-5000N Operator's Guide

P3PC-1132-07ENZ0

Date of issuance: August, 2009

Issuance responsibility: PFU LIMITED

- Copying of the contents of this manual in whole or in part and copying of the scanner application is forbidden under the copyright law.
- The contents of this manual are subject to change without notice.
- PFU LIMITED. is not liable whatsoever for any damages resulting from use of this scanner and procedures described in this manual, profit loss due to defects, and any claims by a third party.