

4.3" COLOR TFT VIDEO DOOR PHONE INDOOR MONITOR

- E430C
- E430C-W32
- E430C-W64

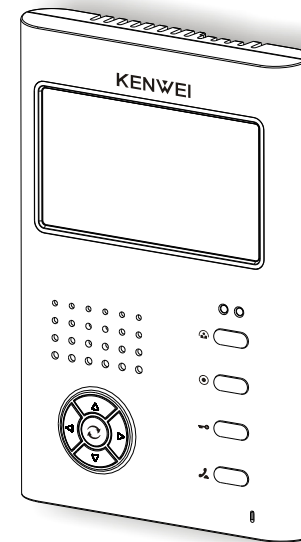

Content

Products Introduction	3
Feature and parts	4
Operation	5
B&W image memory introduction	8
B&W image memory operation	8
OSD menu operation	9
Specifications and accessories	11
Installation	12
Installation attention	14
Connection diagram	15
Wiring length and wire material requirement	15
Connection between monitor and camera (1-1)	15
Connection between monitor and camera (1-2)	16
Connection between 1 monitor, 2 camera and 1 sub-phone KW-111	17
Troubles shooting guide	18
Parameters	19

Products Introduction

Thank you for purchasing our product of building intercom system series. Please read the instructions carefully and follow the directions before installing the products. Any problem regarding to the product, please inquire your supplier.

General features:

- Monitor and remote unlock
- Kinds of chord ring for option, with clear tone
- Color, brightness and contrast adjustable
- No bother (mute) function
- Support B&W image memory
- Talk volume adjustable



Caution: To avoid the risk of electric shock, please don't remove cover or back. Please ask professional person if maintenance needed.



Remind users that important operation and maintenance guide are included in the attached user's manual.

Remark

* KENWEI reserves the right to change or modify design, features, functions and specifications without any prior notice for the improvement and promotion of products' quality.

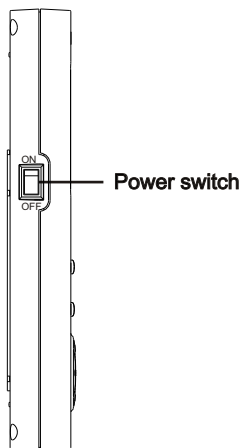
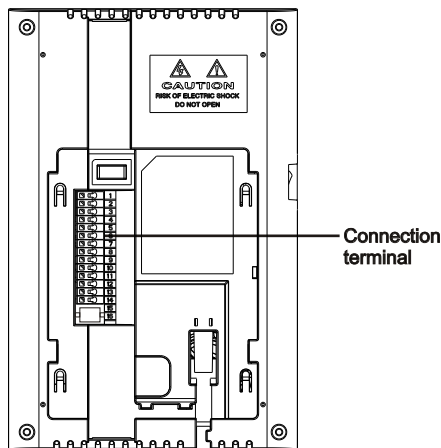
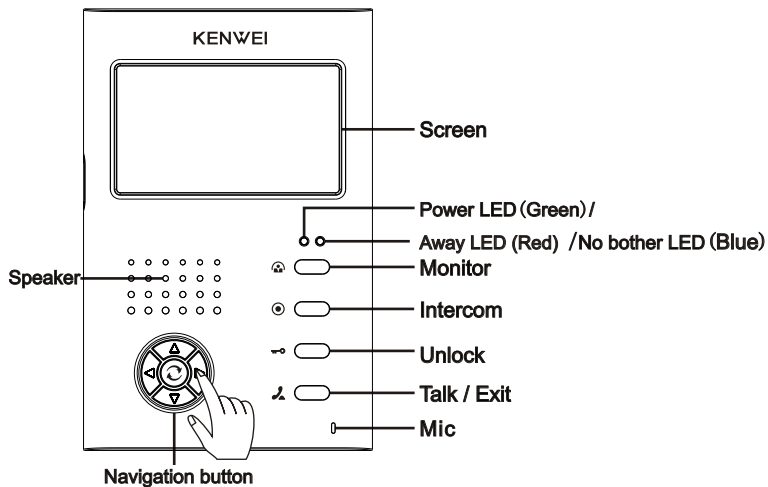

1.ON / OFF

- a. After connect the power, dial the power switch to ON (pic. 1), the unit will automatically enter into standby mode, power LED light (green).
- b. Dial the power switch to OFF (pic. 1), the power would be closed, the unit will enter into OFF mode, power LED turn off.

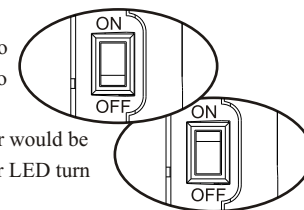

Pic. 1

2.Call remind

a.Door 1 calls in

When Door 1 calls in, the indoor monitor will automatically display its image, and display CH1 on the picture. Also sounds ring at the same time. (no ringing under no bother mode.)

b.Door 2 calls in

When Door 2 calls in, the indoor monitor will automatically display its image, and display CH2 on the picture. Also sounds ring at the same time. (no ringing under no bother mode.)

c.Intercom

When monitor A calls sub-phone, both of units will sound “DO LONG DONG” at intervals.

3.Monitor / Exit

a. Under standby mode, press “” (pic. 2) to monitor Door 1, and display CH1 on the picture. The unit will automatically exit monitor mode and back to standby after 90s.

b. Under Door 1 monitor mode, press “” (pic. 2) again to monitor Door 2, and display CH2 on the picture. The unit will automatically exit monitor mode and back to standby after 90s.

Remark: under monitor mode, only picture without voice, and cannot open the door.

c. Under Door 2 monitor mode, press “” (pic. 2) to exit monitor mode, and back to standby.

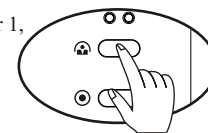

Pic. 2

4.Talk / Stop

a.Call to talk:

When outdoor camera calls in, indoor monitor will sound ring. Press “” (pic. 3) to enter into talk mode.

b.Monitor to talk:

Under monitor mode, press “” (pic. 3) to enter into talk mode.

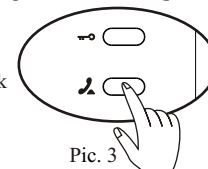

Pic. 3

Operation

c.Stop:

Under talk mode, press “” (pic.3) to exit talk, and back to standby. Or after 90s the system will auto exit.

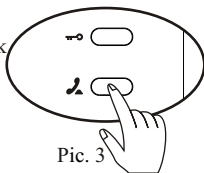

Pic. 3



5.Unlock

Under talk mode, press “” (pic. 4) to open the door.



Pic. 4

6.Chord ring select

Under standby mode, press “” or “” (pic.5), the unit will sound the current ring. Then each time you pressing, the ring would be changed. Choose the one you need and press “” (pic. 3) to save. Or the unit will automatically save the ring after 30s. (Current saved ring is for Door 1, Door 2's ring is the next one of Door 1.)

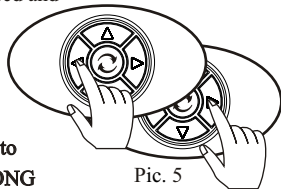

Pic. 5

Remark: After power off, the unit's ring is default to DING DONG. Intercom ring is default to “DU LONG DONG” at intervals, cannot change.

7.Ring volume adjust

Under chord ring select mode, press “” (pic.6) to adjust the ring volume.



Pic. 6

8.No bother mode

a.Under standby mode, press and hold “” (pic.2), no bother LED light, and the unit sounds DI, now is no bother mode.

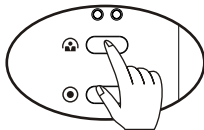

Pic. 2

b.Under no bother and standby mode, press and hold “” (pic.2) till no bother LED turn off, and the unit sounds DI DI, now exit no bother mode.

9.Away management mode (pass this item if the unit without memory)

a.Under standby mode, press “” (pic. 7), away management LED light, means the unit is under away management mode.

b.Under standby mode, press “” (pic.7), when the away management LED turns off, means the unit exit this mode.

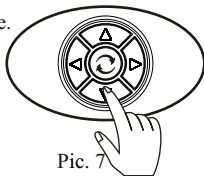

Pic. 7

Operation

10.Navigation button

Under monitor / talk mode, the navigation button is default to OSD menu. Now press “” (pic.8), you can choose OSD menu or image memory.

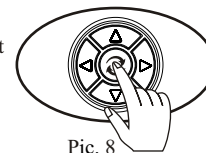

Pic. 8

11.Intercom

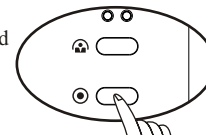

a.Main monitor calls sub-phone KW-111

When the sub-phone is under standby mode, press and hold “” (pic.9), now both 2 units will sound “DU LONG DONG” at intervals. Pickup sub-phone's handset to talk.



Pic. 9

b.Sub-phone KW-111 calls main monitor E430C

When the main monitor is under standby mode, pickup sub-phone's handset and hold “” (pic.9), now the main monitor will sound “DU LONG DONG”. Press main monitor's “” (pic.3) to talk.

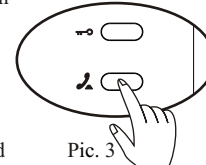

Pic. 3

12.Outdoor call transfer (with sub-phone KW-111)

Under talk mode (monitor and camera talk), press and hold “” (pic.9), the main monitor / sub-phone KW-111 and relevant outdoor camera will sound “DU LONG DONG” at intervals. Now pick up KW-111's handset to talk.

B&W image memory introduction

The unit with B&W image memory has the following function:

1.Record picture

The unit can record the picture with time display, max. to 64pcs.

2.Review picture

The users can review the picture under monitor or talk mode.

3.Auto-off function

During picture reviewing, if you don't press any button which related to image memory, the unit will automatically exit image memory mode after 10s.

4.Time display and edit

During operation of image memory, the unit will display the time, and you can edit time and date. (under normal condition, time will not display)

5.Away management function

Under away management mode, the system will automatically record each calling's picture.

B&W image memory operation

a. Under away management mode, if somebody calls in, the unit will automatically enter into monitor mode, and record current picture. The users could open monitor mode, switch “↻” button to image memory mode, then press “▶” to review the recorded picture.

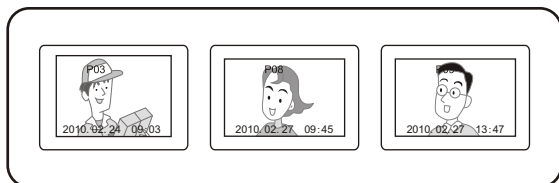

b. Under monitor mode, switch “↻” button to image memory, then press “◀” to record one picture with time display. Max. to 32 or 64pcs. Over that, the system will automatically cover the oldest picture.

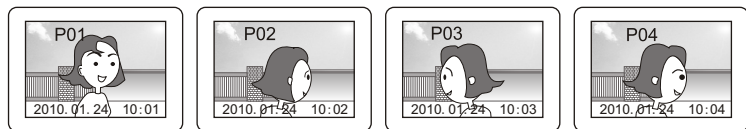

c. Under monitor mode, switch “↻” button to image memory, press “△” to choose the time or date you need edit, then press “▶” to edit. Press “△” to finish edit and back to time setup mode.

Remark: Under power off condition, all of the recorded information would be lost.

OSD menu operation

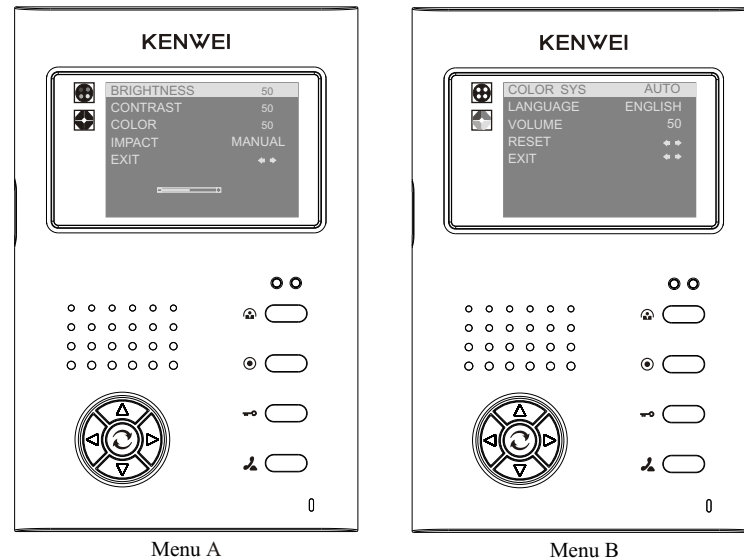

Under OSD menu, you could adjust talk volume, contrast, color, language, etc. Turn on the screen, press “↻” to OSD menu, press “△” or “▽” to open menu A, then press “△” or “▽” to choose the item you need adjust. After menu A's EXIT item, press “▽” you can see menu B.

1. Talk volume adjust

Under monitor or talk mode, the navigation button is default to OSD menu, now press “◀” / “▶” to adjust talk volume.

2. Brightness, color, contrast adjust

Under OSD menu mode, turn on menu A, press “▽” to choose Brightness, Contrast and Color item, then press “▶” to increase, “◀” to decrease.

3. Picture impact

Under OSD menu mode, turn on menu A, press “▽” to choose IMPACT item, then press “◀” / “▶” to adjust between bright, soft, standard and manual.

4. Color system

Under OSD menu mode, turn on menu B, press “▽” to choose COLOR SYS item, then press “◀” / “▶” to adjust between AUTO, NTSC and PAL.

Operation

5.OSD menu language

Under OSD menu mode, turn on menu B, press “ ▾ ” to choose language, then press “ ◀ ” / “ ▶ ” to choose the language you need.

6.Picture quality reset

Under OSD menu mode, turn on menu B, press “ ▾ ” to choose RESET item, then press “ ◀ ” / “ ▶ ” to choose reset.

7.Exit OSD menu

Under OSD menu mode, turn on menu B, press “ ▾ ” to choose EXIT item, then press “ ◀ ” / “ ▶ ” to exit. Or after 10s, the unit will automatically exit.

Specifications and accessories

Specifications

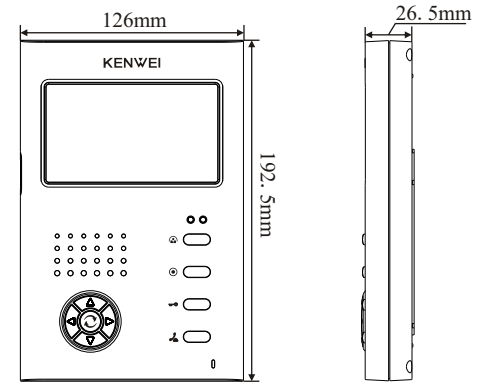

Accessories

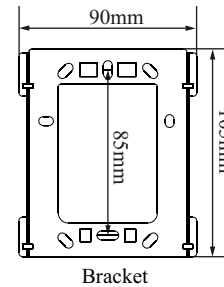

Screw: +P4×25TP1



Expansion plug: $\phi 6 \times 30\text{mm}$

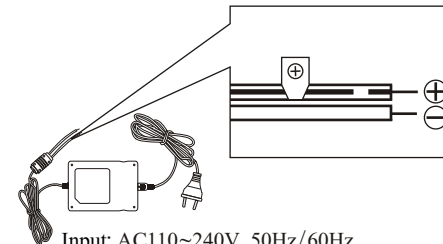

Input: AC110~240V, 50Hz/60Hz

Output: DC13.5V/1.5A

Power adaptor (option), without it when the unit is AC power.

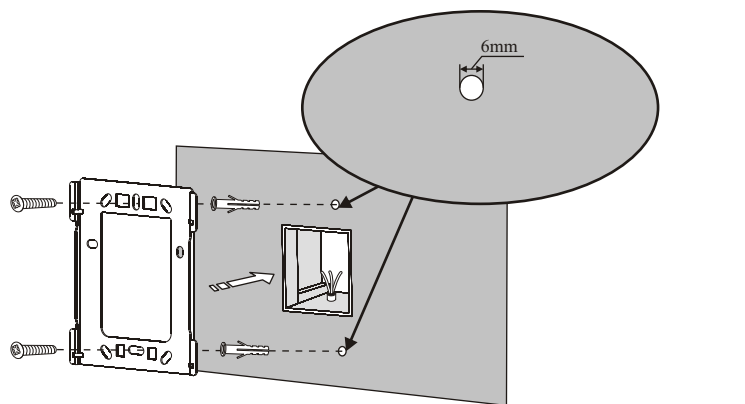

1. Concealed wiring: fix the bracket on the connection box.
 Open wiring: drill 2 holes (8.4cm distance), insert the expansion plug to the hold, then fix the bracket.

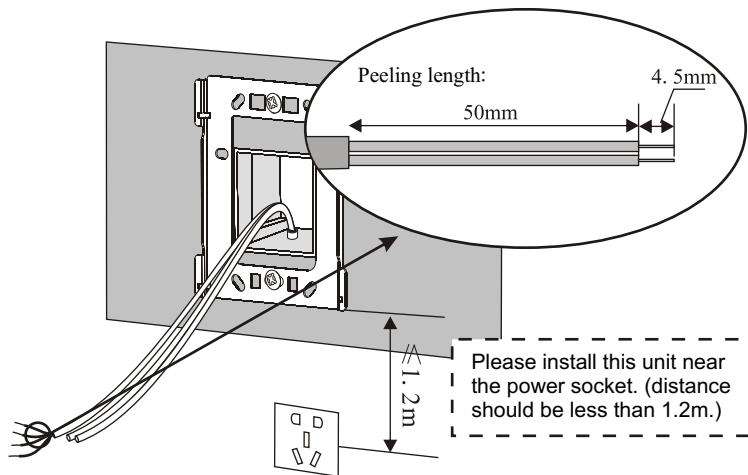
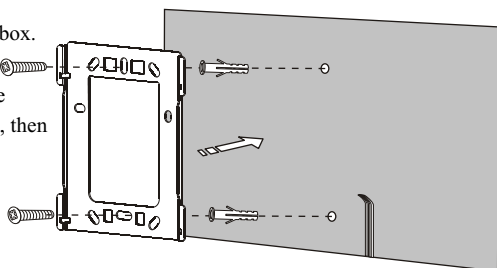

2. As the picture shows, peel the wire after pull out the wire from the wall. Peeling length please refer to the picture.

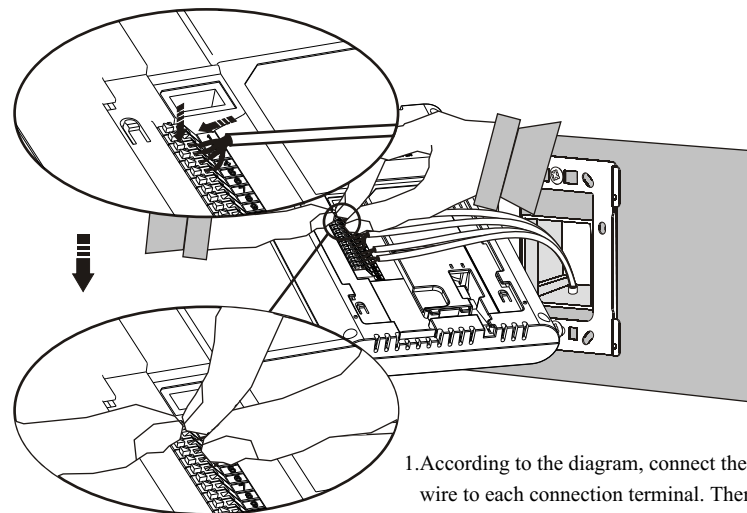

1. According to the diagram, connect the wire to each connection terminal. Then check if the wire is firm enough.

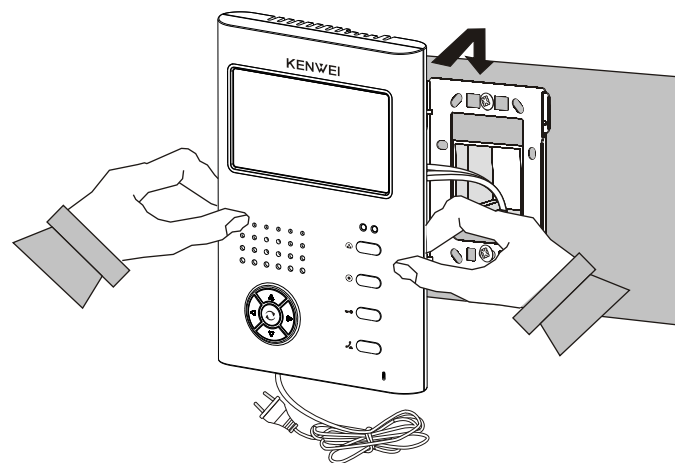

5. After connection, pack up the wire and insert to the connection box. Then hang up the unit to the bracket. (after that, power on the unit and test.)

Installation attention

1. When you choose the place to install the unit, please pay attention to:

Keep sufficient space for ventilation and easy communication.

Keep sufficient space to adjust while installing.

Not put hot resource under the unit.

The socket outlet shall be installed near the equipment and shall be easily accessible.

2. Do not expose the unit to sunshine or rain:

Even if you do not use it, don't expose it to sunshine or rain.

3. Do not expose to intense light:

Spotlight may cause stain or striation in the screen.

4. Do not disassemble the unit by yourself:

Improper disassembly may damage the unit or cause electric shock.

5. Do not splash water on the unit:

Install the unit in dry place. In case that the unit gets wet, turn off the unit and contact your dealer.

6. Check the ambient temperature and humidity:

Avoid using the unit where the temperature is hotter or colder than specified, otherwise the internal parts may get affected. Special care is required to use the unit at high temperature and humidity.

7. In case of trouble:

If any trouble occurs while you are using the unit, turn off the power and contact your dealer to avoid worse problem or unpredictable accident.

8. About operation:

Keep the unit away from magnetic equipments such as microwave oven or big speaker. If the unit will not be used for a long time, please switch it off.

9. About clean:

Use soft cloth to clean the unit. Do not use any impregnant, such as alcohol, benzene. If you have any problem, please contact your dealer.

Connection diagram

Wiring length and wire requirement

Wiring length	30M	50M	100M
Wire requirement from door camera to the main monitor	RVV4*0.3mm ²	RVV4*0.5mm ²	RVV4*0.75mm ²
Wire requirement from main monitor to sub-phone	RVV4*0.3mm ²		/

Connection between monitor and camera (1-1)

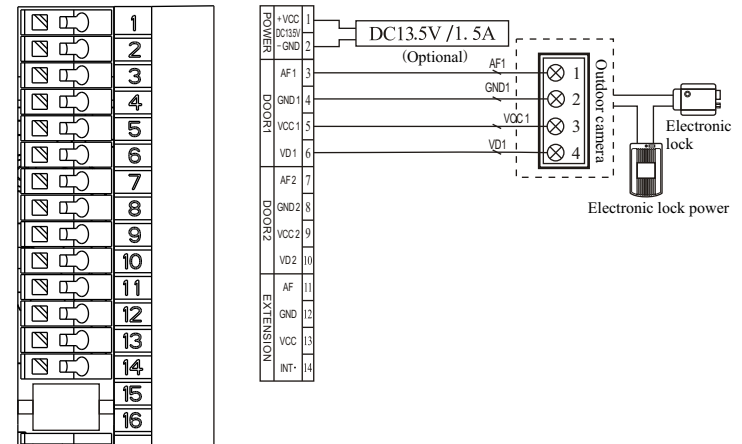
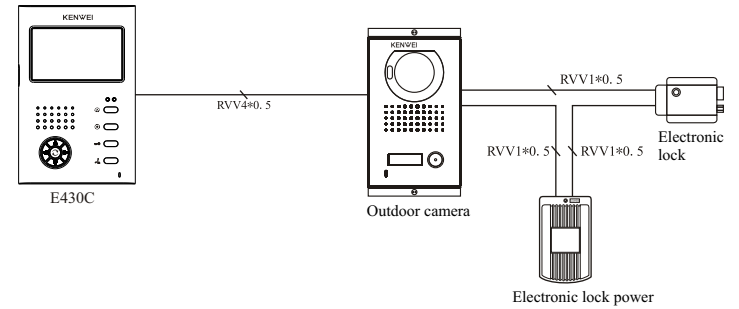

Connection terminal on the back of unit

Connection diagram

Connection between monitor and camera (1-2)

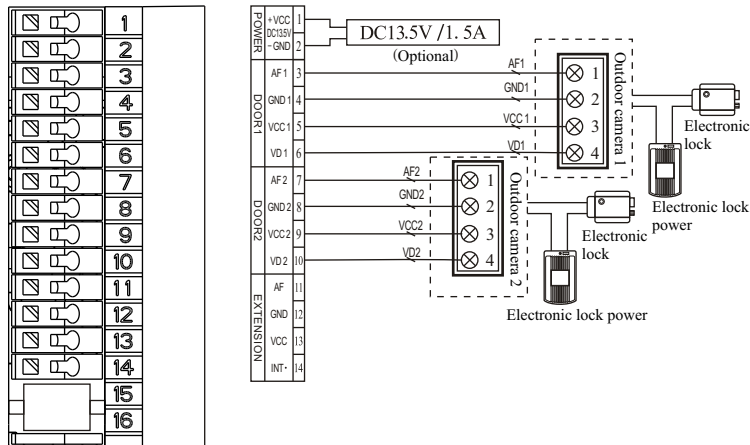
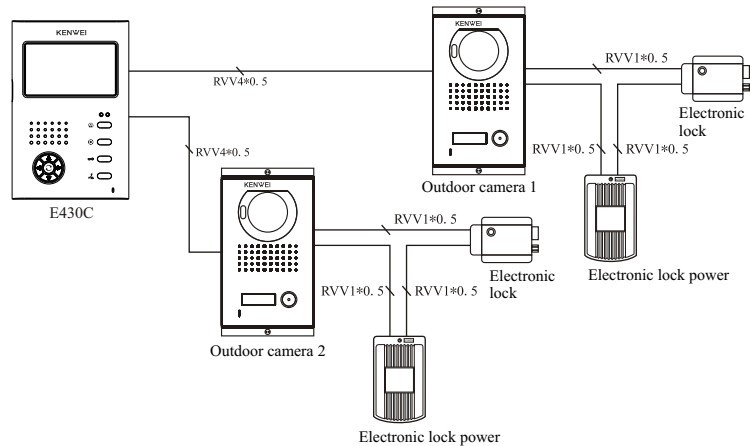

Connection terminal on the back of unit

Connection diagram

Connection between 1 monitor, 2 camera and 1 sub-phone KW-111

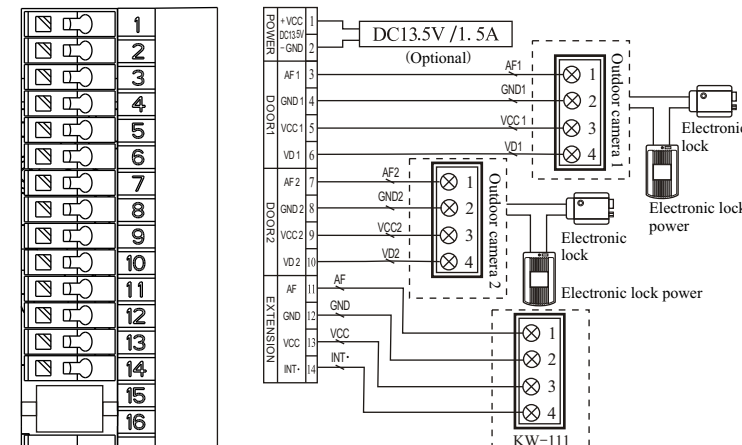
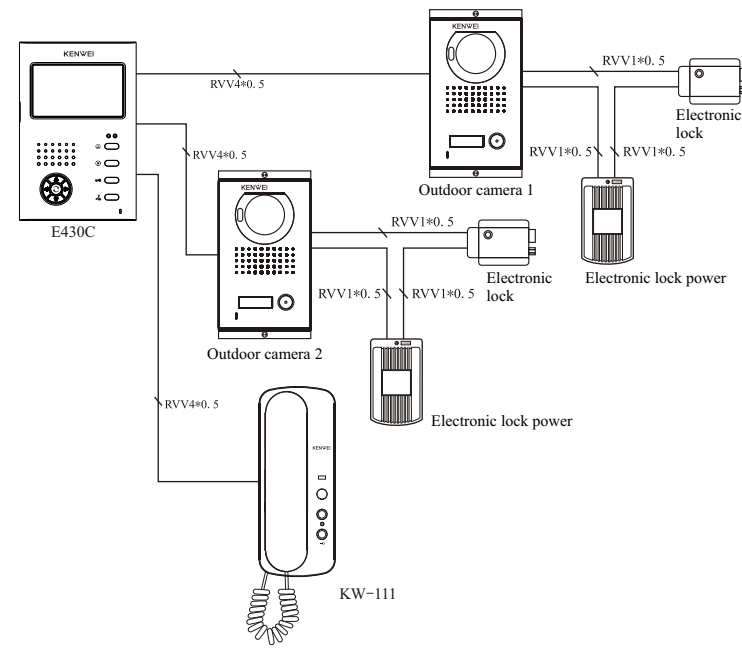

Connection terminal on the back of unit

Troubles shooting guide

Problem	Possible reason	Solution
The unit don't work at all.	<ul style="list-style-type: none"> ➤ The unit hasn't connect power supply. ➤ The unit is under OFF mode. 	<ul style="list-style-type: none"> ➤ Check if the power is connected well. ➤ On the unit.
Outdoor camera cannot call.	<ul style="list-style-type: none"> ➤ The connection between outdoor and indoor unit is cut off. ➤ Main monitor is OFF. 	<ul style="list-style-type: none"> ➤ Check the wiring between outdoor and indoor unit. ➤ On the unit.
Outdoor can hear indoor, but the voice which indoor heard is lower.	<ul style="list-style-type: none"> ➤ Talk volume is lower. 	<ul style="list-style-type: none"> ➤ Adjust the talk volume to best quality.

Parameters

Number Item	E430C	E430C-W32	E430C-W64
Screen	4.3" color TFT		
Power supply	AC100-240V 50Hz/60Hz 15W or DC13.5V / 1.5A		
Sub-phone connection	In series		
Talk	Hands-free		
Power consumption	13.5V, 500mA (max)	13.5V, 500mA (max)	13.5V, 500mA (max)
Optional ring	Chord ring / Ding Dong		
Operation temperature	-10°C ~ +55°C		
Optional sub-phone	KW-111		
Optional outdoor camera	All our 4-wires outdoor camera		