



AXIS 209FD-R Fixed Dome Network Camera

User's Manual

About this Document

This manual is intended for administrators and users of the AXIS 209FD-R Network Camera, and is applicable for software release 4.42 and later. It includes instructions for using and managing the camera on your network. Previous experience of networking will be of use when using this product. Some knowledge of UNIX or Linux-based systems may also be beneficial, for developing shell scripts and applications. Later versions of this document will be posted to the Axis Website, as required. See also the product's online help, available via the Web-based interface.

Safety Notices Used In This Manual

Caution! - Indicates a potential hazard that can damage the product.
Important! - Indicates a hazard that can seriously impair operation. Do not proceed beyond any of the above notices until you have fully understood the implications.

Intellectual Property Rights

Axis AB has intellectual property rights relating to technology embodied in the product described in this document. In particular, and without limitation, these intellectual property rights may include one or more of the patents listed at <http://www.axis.com/patent.htm> and one or more additional patents or pending patent applications in the US and other countries.

This product contains licensed third-party software. See the menu item "About" in the product's user interface for more information.

This product contains source code copyright Apple Computer, Inc., under the terms of Apple Public Source License 2.0 (see <http://www.opensource.apple.com/apsl/>). The source code is available from: <http://developer.apple.com/darwin/projects/bonjour/>

Legal Considerations

Video and audio surveillance can be prohibited by laws that vary from country to country. Check the laws in your local region before using this product for surveillance purposes.

This product includes one (1) MPEG-4 decoder license. To purchase further licenses, contact your reseller.

Electromagnetic Compatibility (EMC)

This equipment generates, uses and can radiate radio frequency energy and, if not installed and used in accordance with the instructions, may cause harmful interference to radio communications. However, there is no guarantee that interference will not occur in a particular installation.

If this equipment does cause harmful interference to radio or television reception, which can be determined by turning the equipment off and on, the user is encouraged to try to correct the interference by one or more of the following measures: Re-orient or relocate the receiving antenna. Increase the separation between the equipment and receiver. Connect the equipment to an outlet on a different circuit to the receiver. Consult your dealer or an experienced radio/TV technician for help. Shielded (STP) network cables must be used with this unit to ensure compliance with EMC standards.

Europe - CE This equipment is not connected to immunity related functions in motor vehicles. It fulfills the requirements of the EMC directive taking into account the automotive environment

Equipment Modifications

This equipment must be installed and used in strict accordance with the instructions given in the user documentation. This equipment contains no user-serviceable components. Unauthorized equipment changes or modifications will invalidate all applicable regulatory certifications and approvals.

Liability

Every care has been taken in the preparation of this manual. Please inform your local Axis office of any inaccuracies or omissions. Axis Communications AB cannot be held responsible for any technical or typographical errors and reserves the right to make changes to the product and manuals without prior notice. Axis Communications AB makes no warranty of any kind with regard to the material contained within this document, including, but not limited to, the implied warranties of merchantability and fitness for a particular purpose. Axis Communications AB shall not be liable nor responsible for incidental or consequential damages in connection with the furnishing, performance or use of this material.

Trademark Acknowledgments

Apple, Boa, Bonjour, Ethernet, Internet Explorer, Linux, Microsoft, Mozilla, Netscape Navigator, OS/2, Real, QuickTime, UNIX, Windows, WWW are registered trademarks of the respective holders. Java and all Java-based trademarks and logos are trademarks or registered trademarks of Sun Microsystems, Inc. in the United States and other countries. Axis Communications AB is independent of Sun Microsystems Inc. UPnP™ is a certification mark of the UPnP™ Implementers Corporation.

Support

Should you require any technical assistance, please contact your Axis reseller. If your questions cannot be answered immediately, your reseller will forward your queries through the appropriate channels to ensure a rapid response. If you are connected to the Internet, you can:

- download user documentation and firmware updates
- find answers to resolved problems in the FAQ database. Search by product, category, or phrases
- report problems to Axis support by logging in to your private support area

- visit Axis Support at www.axis.com/techsup/

WEEE Directive

The European Union has enacted a Directive 2002/96/EC on Waste Electrical and Electronic Equipment (WEEE Directive). This directive is applicable in the European Union member states.



The WEEE marking on this product (see right) or its documentation indicates that the product must not be disposed of together with household waste. To prevent possible harm to human health and/or the environment, the product must be disposed of in an approved and environmentally safe recycling process. For further information on how to dispose of this product correctly, contact the product supplier, or the local authority responsible for waste disposal in your area.

Business users should contact the product supplier for information on how to dispose of this product correctly. This product should not be mixed with other commercial waste.

AXIS 209FD-R User's Manual Rev 1.0
March 2007
Copyright© Axis Communications AB, 2007

Contents

Product overview	4
Description	4
Key features	4
Overview	5
LED indicators	6
Accessing the Camera	7
Access from a browser	7
Setting the Password	8
Accessing the camera from the Internet	8
The Live View Page	8
Video Streams	9
How to stream MPEG-4	9
MPEG-4 clients	10
Motion JPEG	10
Configuration	11
Accessing the Setup tools	11
AXIS Media Control	11
Video & Image settings	12
Overlay/Mask	13
Advanced - Camera Settings	13
Advanced - MPEG-4 Settings	13
Live View Config	14
Layout	14
Event Configuration	16
Event Servers	16
Event Types	16
Triggered Events	17
Scheduled Events	18
Camera Tampering	18
Motion Detection	19
System Options	20
Security	20
Date & Time	21
Network - Basic TCP/IP Settings	21
Network - Advanced TCP/IP Settings	22
SOCKS	24
QoS (Quality of service)	24
SMTP (email)	24
SNMP	24
UPnP™	25
RTP / MPEG-4	25
Bonjour	25
LED Settings	25
Maintenance	25
Support	25
Resetting to the Factory Default Settings	26
Advanced	26
Troubleshooting	27
Technical Specifications	31
General performance considerations	33
Bandwidth	33
Glossary of Terms	35
Index	40

Product overview

Description

The AXIS 209FD-R Fixed Dome Network Camera is a high-performance, progressive-scan camera for use in professional in-vehicle surveillance. Its discreet, compact casing effectively protects against tampering. The product casing also allows it to be used in humid environments.



Multi-window motion detection and simultaneous Motion JPEG and MPEG-4 allow for optimization both on image quality and bandwidth efficiency. The frame rate can be up to 30 fps in VGA.

Multi-level password protection, IP-address filtering and HTTPS encryption ensure network security. Power over Ethernet reduces cabling requirements and enables centralized power back up. Supported by the industry's largest base of surveillance applications, this camera is the perfect solution for securing e.g. buses, trains, trams, or other types of transportation vehicle.

Key features

- Discreet and compact design, effectively protecting against tampering/vandalisation
- Superior image quality with progressive scan and 30 frames per second in VGA
- Simultaneous Motion JPEG and MPEG-4 for optimized quality and bandwidth
- Power over Ethernet for reduced cabling and consolidated power
- Multi-window motion detection with alarm image buffering

Overview

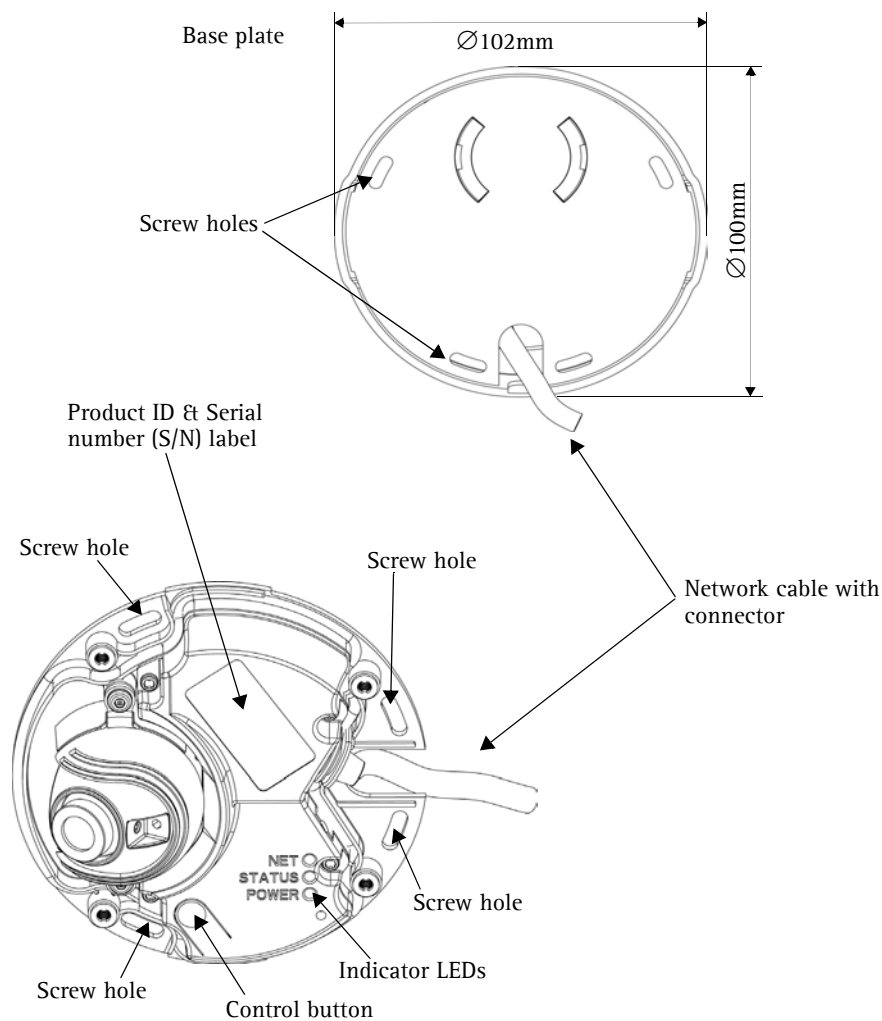
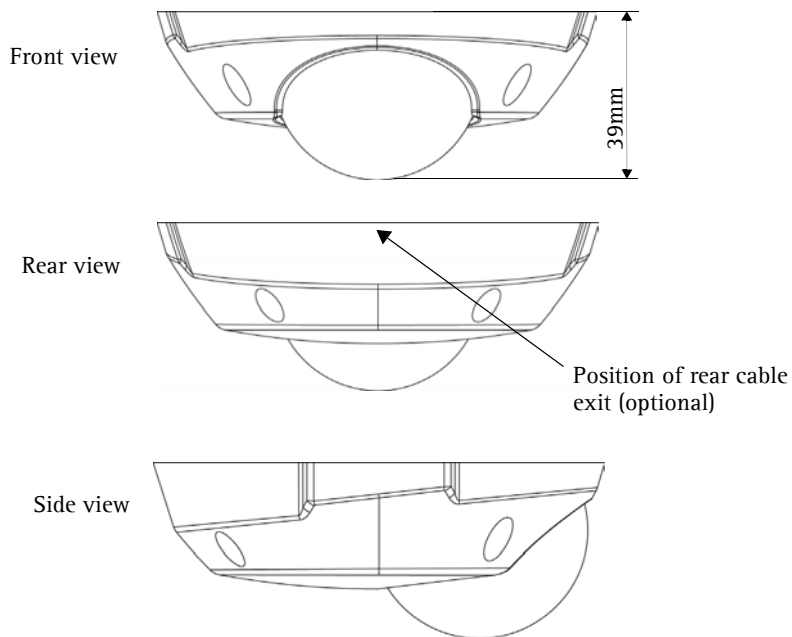

Dimensions

Diameter 1 = 102mm (4.02"), Diameter 2 = 100mm (3.94")
 Height = 39mm (1.54")
 Weight = 0.18 kg (0.40lb)

Control Button - Press this button to install using the AXIS Internet Dynamic DNS Service, or to restore the factory default settings, as described in *Resetting to the Factory Default Settings*, on page 26.

LED indicators

LED	Color	Description
Network	Green	Steady for connection to 100 Mbit/s network. Flashes for network activity.
	Amber	Steady for connection to 10 Mbit/s network. Flashes for network activity.
	Unlit	No connection.
Status	Green	Shows steady green for normal operation. Note: The Status LED can be configured to be unlit during normal operation, or to flash only when the camera is accessed. See the online help files for more information. Go to Setup > System Options > LED settings
	Amber	Steady during startup, reset to factory default or when restoring settings.
	Red	Slow flash for failed upgrade.
Power	Green	Normal operation.
	Amber	Flashes green/amber during firmware upgrade.

Accessing the Camera

Before accessing the camera it must be installed. Please see the installation guide supplied with the product.

The camera can be used with most standard operating systems and browsers. The recommended browser is Microsoft Internet Explorer with Windows, Safari with Macintosh and Mozilla with other operating systems.

- Notes:**
- To view streaming video in Microsoft Internet Explorer, set your browser to allow ActiveX controls and allow the AXIS Media Control (AMC) to be installed on your workstation.
 - QuickTime™ and Real Player™ are also supported for viewing streaming MPEG-4 video and audio.
 - If your workstation restricts the use of additional software components, it is also possible to use the Mozilla or Firefox browsers, neither of which require extra components.
 - The AXIS 209FD-R includes one (1) decoder license for viewing MPEG-4 video streams. This is automatically installed with AMC. The administrator can disable the installation of the MPEG-4 decoder, to prevent unlicensed copies being installed. Further licenses are available from your Axis dealer.

Access from a browser

1. Start a browser (e.g. Internet Explorer, Mozilla)
2. Enter the IP address or host name of the camera in the **Location/Address** field of your browser.

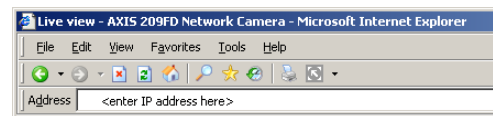

To access the camera from a Macintosh computer (Mac OSX), simply click on the Bonjour tab and select the AXIS 209FD-R from the drop-down list.

3. If this is the first time the camera is accessed, see *Setting the Password*, on page 8. Otherwise enter your user name and password, as set by the administrator.
4. The camera's Live View page is now displayed in your browser.

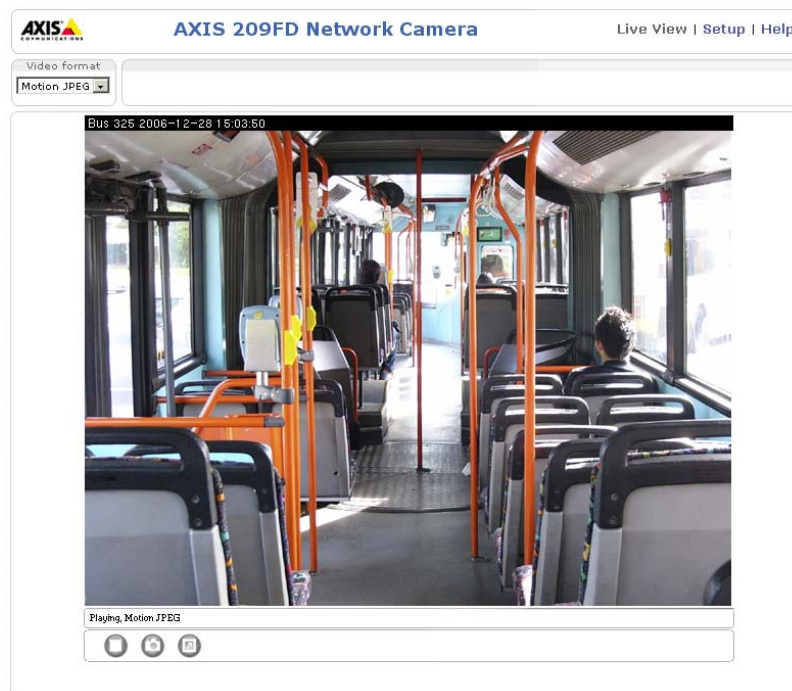

Note: The layout of the Live View page may have been customized to specific requirements. Consequently, some of the examples and functions featured here may differ from those displayed on your own Live View page.

Setting the Password

1. When accessing the camera for the first time, the 'Configure Root Password' dialog will be displayed on the screen.
2. Enter a password and then re-enter it, to confirm the spelling. Click OK.
3. After the password has been set, to access the camera, enter the user name: root
Note: The default administrator user name root is permanent and cannot be deleted.
4. Enter the password as set in step 2 above, and click OK. If the password is lost, the camera must be reset to the factory default settings. See page 26.
5. If required, click Yes to install the AXIS Media Control (AMC). You will need administrator rights on the computer to do this.

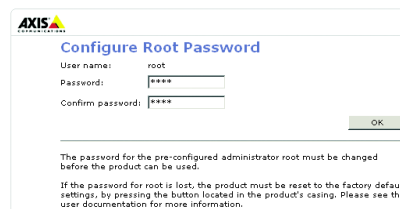

Accessing the camera from the Internet

Once installed, the camera is accessible on your local network (LAN). To access the camera from the Internet you must configure your broadband router to allow incoming data traffic to the camera. To do this, enable the NAT-traversal feature, which will attempt to automatically configure the router to allow access to the camera. This is enabled from **Setup > System Options > Network > TCP/IP Advanced**.

For more information, please see *NAT traversal (port mapping) for IPv4*, on page 22. See also the AXIS Internet Dynamic DNS Service at www.axiscam.net or, for Technical notes on this and other topics, visit the Axis Support Web at www.axis.com/techsup

The Live View Page

Depending on whether or not the Live View page has been customized, the buttons described below may or may not be visible.

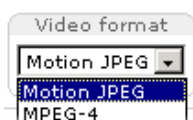

The **Video Format** drop-down list allows the video format on the Live View page to be temporarily changed.



The **manual trigger button** can trigger an event directly from the Live View page. This is configured from **Setup > Live View Config > Layout**.



The **Snapshot** button saves a snapshot of the video image currently being displayed. Right-click on the video image to save it in JPEG format on your computer. This button is primarily intended for use when the AMC viewer toolbar is not available.

The AMC (AXIS Media Control) viewer toolbar is available in **Microsoft Internet Explorer only**. It displays the following buttons:



The **Play/Stop** button starts and stops the live video stream.



The **Snapshot** button saves a snapshot of the video image currently being displayed. The Snapshot function and the target directory for saving snapshots can be configured from the AMC Control Applet in the Windows Control Panel (Internet Explorer only).



Click the **View Full Screen** button to make the video image fill the entire screen area. No other windows will be visible. Press Esc (Escape) on the computer keyboard to exit full screen.



Click the **Record** button to start an MPEG-4 recording (only available when viewing MPEG-4).

Video Streams

The AXIS 209FD-R provides several different image and video stream formats. The type to use depends on your requirements and on the properties of your network.

The Live View page provides access to MPEG-4 and Motion JPEG video streams, as well as to single JPEG images. Other applications and clients can also access these video streams/images directly, without going via the Live View page.

How to stream MPEG-4

This video compression standard makes good use of bandwidth, and can provide DVD-quality video streams at less than 1 Mbit/s. Note that the image settings of the MPEG-4 stream are the same for all clients.

Deciding on the combination of protocols and methods to use depends on your viewing requirements, and on the properties of your network. The options available in AMC (see page 10) are:

Unicast RTP	This unicast method (RTP over UDP) should be your first consideration for live unicast video, especially when it is important to always have an up-to-date video stream, even if some images are dropped.	Unicasting is used for video-on-demand broadcasting, so that there is no video traffic on the network until a client connects and requests the stream. Note that there is a maximum of 10 simultaneous unicast connections.
RTP over RTSP	This unicast method (RTP tunneled over RTSP) is useful as it is relatively simple to configure firewalls to allow RTSP traffic.	
RTP over RTSP over HTTP	This unicast method can be used to traverse firewalls. Firewalls are commonly configured to allow the HTTP protocol, thus allowing RTP to be tunneled.	
Multicast RTP	This method (RTP over UDP) should be used for live multicast video. The video stream is always up-to-date, even if some images are dropped. Multicasting provides the most efficient usage of bandwidth when there are large numbers of clients viewing simultaneously. A multicast broadcast cannot however, pass a network router unless the router is configured to allow this. It is thus not possible to multicast over e.g. the Internet. Note also that all multicast viewers count as one unicast viewer in the maximum total of 10 simultaneous connections.	

AMC will negotiate with the camera to determine exactly which transport protocol to use in the order listed above. This order can be changed and the options disabled, to suit any specific requirements.

Important!

MPEG-4 is licensed technology. The AXIS 209FD-R includes one viewing client license. Installing additional unlicensed copies of the viewing client is prohibited. To purchase additional licenses, contact your Axis reseller.

MPEG-4 clients

AXIS Media Control (AMC)

The recommended method of accessing live video (MPEG-4 and Motion JPEG) from the AXIS 209FD-R is to use the AXIS Media Control (AMC) in Microsoft Internet Explorer in Windows.

The AMC control panel can be used to configure various video and audio settings. Please see the readme file included in the tool for more information.

The AMC control panel is automatically installed on first use, after which it can be configured.

Open the AMC Control Panel from:

- Windows Control Panel (from the Start menu)
- Alternatively, right-click the video image in Internet Explorer and click Settings in the menu.

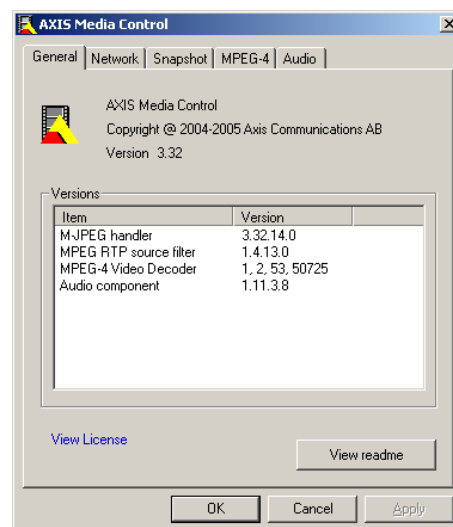

QuickTime™ & Real Player™

To access the video stream from e.g. QuickTime™ or Real Player™ the following path can be used:

`rtsp://<ip>/mpeg4/media.amp`

- Notes:**
- The AXIS 209FD-R supports QuickTime 6.5.1 (or later) and Real Player 10.5 (or later)
 - QuickTime adds latency to the video and audio stream (up to 3 seconds)
 - It may be possible to use other players to view the MPEG-4 stream using the paths above, although this is not guaranteed by Axis
 - <ip> = IP address

Motion JPEG

This format uses standard JPEG still images for the video stream. These images are then displayed and updated at a rate sufficient to create a stream that shows constantly updated motion.

The Motion JPEG stream uses considerable amounts of bandwidth, but provides excellent image quality and access to each and every individual image contained in the stream. The recommended method of accessing Motion JPEG live video from the AXIS 209FD-R is to use the AXIS Media Control (AMC) in Microsoft Internet Explorer in Windows.

Note also that multiple clients accessing Motion JPEG streams can use different image settings.

Alternative methods of accessing the video stream

Video/images from the AXIS 209FD-R can also be accessed in the following ways:

- Motion JPEG server push (if supported by the client, e.g. Mozilla/Firefox). This option maintains an open HTTP connection to the browser and sends data as and when required, for as long as required.
- Still JPEG images in a browser. Enter e.g. the path: `http://<ip>/axis-cgi/jpg/image.cgi?resolution=320x240`
- Windows Media Player. This requires AMC and the MPEG-4 viewing client to be installed. The paths that can be used are listed below in the order of preference.
 - Unicast via RTP: `axrtpu://<ip>/mpeg4/media.amp`
 - Unicast via RTSP: `axrtsp://<ip>/mpeg4/media.amp`
 - Unicast via RTSP, tunneled via HTTP: `axrtsphhttp://<ip>/mpeg4/media.amp`
 - Unicast via RTSP, tunneled via HTTPS: `axrtsphhttps://<ip>/mpeg4/media.amp`
 - Multicast: `axrtpm://<ip>/mpeg4/media.amp`

Note: <ip> = IP address

Configuration

This section describes how to configure the camera, and is intended for product **Administrators**, who have unrestricted access to all the Setup tools, and **Operators**, who have access to the settings for Video & Image, Audio, Live View Config and Event Configuration.

The camera is configured from **Setup**, from a standard browser. (For supported browsers, see *Technical Specifications*, on page 31).

The descriptions below show examples of the features available in the AXIS 209FD-R. For details of each setting, please refer to the online help available from the setup tools. Click  to access the online help.

Accessing the Setup tools

Follow the instructions below to access the Setup Tools from a browser.

1. Start your browser and enter the IP address or host name of the camera in the location/address field.
2. The Live View page is now displayed. Click **Setup** to display the Setup tools.

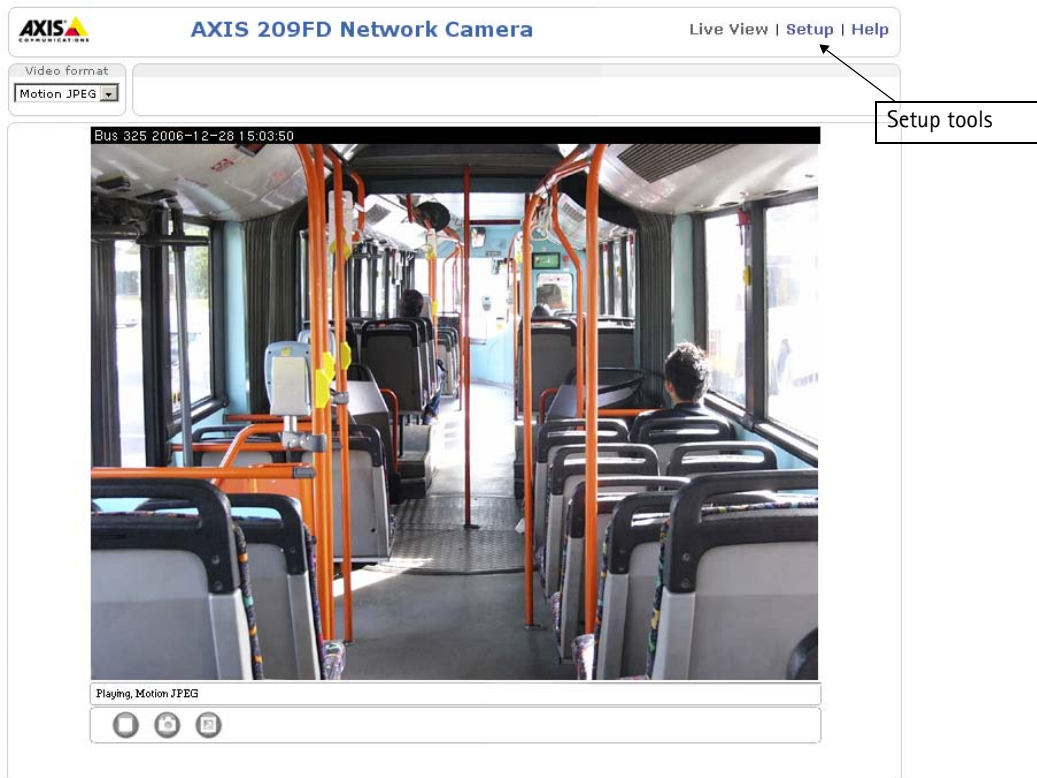

AXIS Media Control

The AXIS Media Control (AMC) is installed automatically the first time the camera is accessed from Microsoft Internet Explorer. The AMC control panel is used to configure various video settings, and can be opened by right-clicking on the video image in the Live View web page. Please see the readme file included in the tool for more information.

Video & Image settings

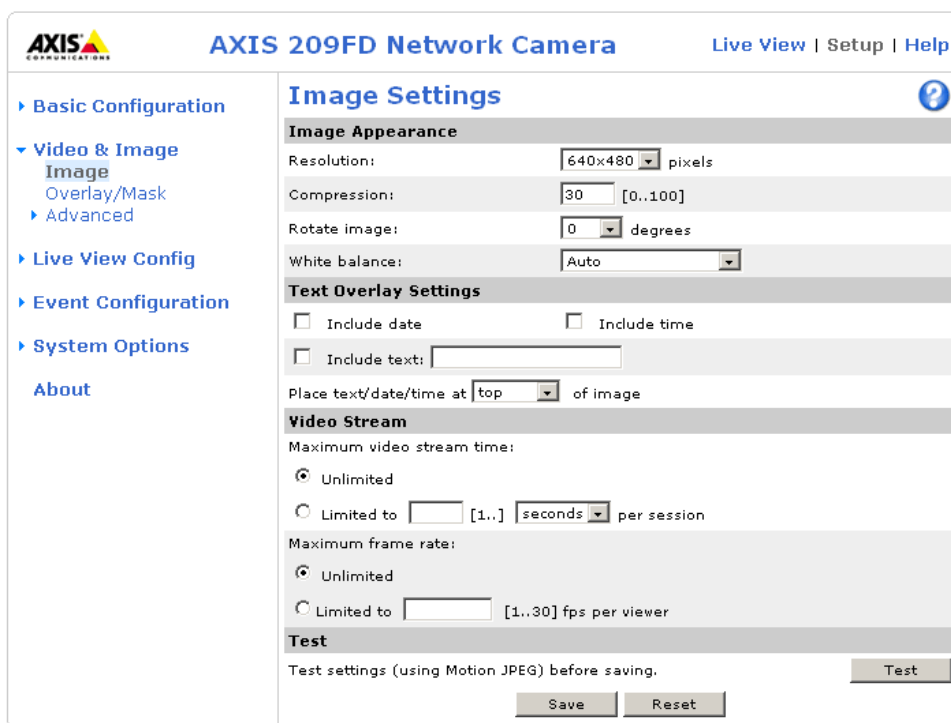

Image Appearance

Use these settings to change the image as required. The image can be rotated, the image resolution and compression can be adjusted, and the white balance can be changed.

The configuration of the video image will affect the camera’s overall performance, depending on how it is used and on the available bandwidth. Setting higher resolution and lower compression improves video image quality, but increases the amount of bandwidth required.

Please see the online help for further information on these settings.

Text Overlay Settings

Use these settings to include a text, date and time overlay.

The text, date and time overlay is included on one line at the top or bottom of the video image.



Video Stream

Define the maximum video stream time per session in seconds, minutes or hours. When the set time has expired, a new stream can be started by refreshing the page in the browser. For unlimited video stream time, select the **Unlimited** radio button. Note that the maximum video stream time does not apply to clients connecting via multicast.

The **frame rate** allowed to each viewer can also be limited, to avoid bandwidth problems on the network. To allow the highest available frame rate, select the **Unlimited** radio button.

For a preview of the image before saving, click **Test**. When satisfied with the settings, click **Save**. Please note that the preview image will be in JPEG format, even though the settings are valid both for Motion JPEG and MPEG-4.

Overlay/Mask

The following options are available for overlays and masks:

- Uploaded image as overlay
- Configurable areas as privacy mask

Uploaded image as overlay is a text and/or a static image superimposed over the video image, for extra information.

Configurable areas as privacy mask are configurable areas of solid color that can be used to block out certain parts of the video image.

Advanced - Camera Settings

This page contains settings for fine-tuning the video image. These include the color level, brightness, sharpness and exposure control.

Please see the online help for further information on these settings.

Low Light Behavior

Exposure priority defines the balance between image quality and the frame rate. Higher image quality may reduce frame rate and increase motion blur. A prioritized frame rate may instead increase image noise. Depending on requirements, use this to give higher priority to the image quality or to the frame rate.

Please refer to the online help for more information [?](#).

Advanced - MPEG-4 Settings

GOV Settings

The GOV structure describes the composition of the MPEG-4 video stream. Setting the GOV-length to a high value saves considerably on bandwidth. The **Cyclic refresh** parameter gives a smoother bit rate and can be useful if bandwidth is limited.

Bit Rate Control

Limiting the maximum bit rate is a good way of controlling the bandwidth used by the MPEG-4 video stream. Leaving the Maximum bit rate as unlimited will provide consistently good image quality, but at the expense of increased bandwidth usage whenever there is more activity in the image. Limiting the bit rate to a defined value will prevent excessive bandwidth usage, but images will be lost when the limit is exceeded.

Note that a maximum bit rate can be used for both variable and constant bit rates.

The bit rate type can be set as Variable Bit Rate (VBR) or Constant Bit Rate (CBR). VBR will adjust the bit rate according to the images' complexity, thus using a lot of bandwidth for a lot of activity in the image and less for lower activity in the monitored area.

CBR allows you to set a fixed Target bit rate that will consume a predictable amount of bandwidth, and which will not change whatever happens in the image.

As the bit rate would usually need to increase for increased image activity, but in this case cannot, the frame rate and image quality will be affected negatively. To go some of the way towards compensating for this, it is possible to prioritize either the frame rate or the image quality whenever the bit rate would normally need to be increased. Not setting a priority means the frame rate and image quality will be affected approximately equally.

Live View Config

Layout

The settings on this page allow you to decide the layout of the Live View page. You can e.g. include action buttons, decide the default video format and the default viewer.

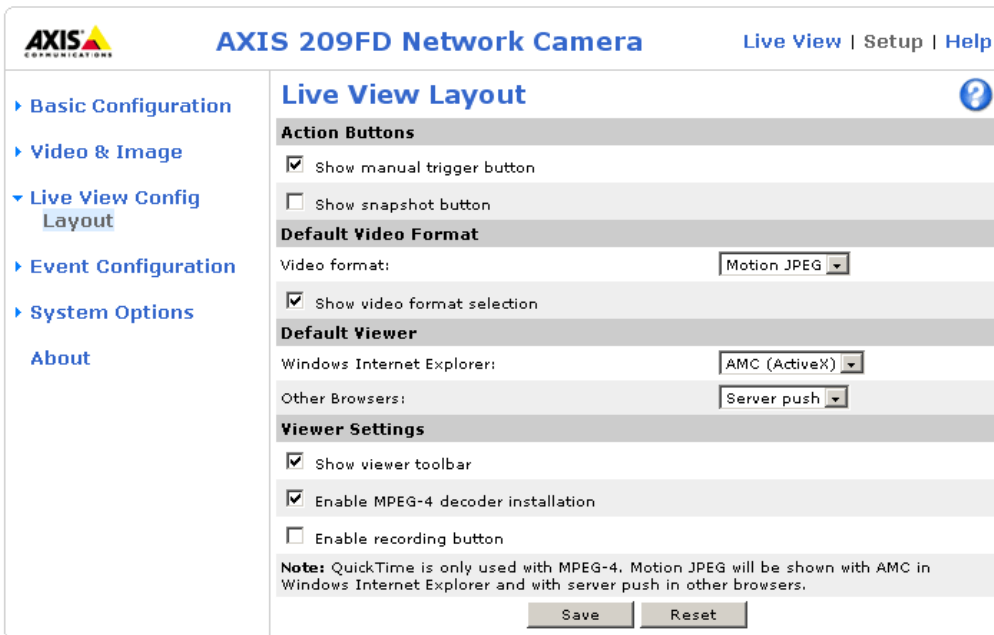

Action Buttons

The **manual trigger** button can be used to manually trigger and stop an event from the Live View page. See *Event Configuration*, on page 16.

Enabling the display of the **Snapshot** button allows users to save a snapshot from the video stream by clicking the button. This button is mainly intended for use with browsers other than Internet Explorer, or when otherwise not using AXIS Media Control (AMC) to view the video stream. AMC (an ActiveX control) for Internet Explorer provides its own snapshot button.

Default Video Format

Select the default video format to use on the Live View page. Checking the box for **Show video format selection** displays a drop-down list on the Live View page allowing you to temporarily change the format.

When using MPEG-4 as the video format, the default viewer is AXIS Media Control with Internet Explorer.

Note: It is also possible to view Motion JPEG when MPEG-4 is chosen as default and vice versa.

Default Viewer

From the drop-down lists, select the default method for viewing video images for your browser. The camera will attempt to show the video images in the selected video format and viewer. If this is not possible, the camera will override the settings and select the best available combination.

Browser	Viewer	Description
Windows Internet Explorer	AMC	Recommended viewer in Windows Internet Explorer (MPEG-4 /Motion JPEG).
	QuickTime	MPEG-4 only.
	Java applet	A slower imaging alternative to AMC. Requires one of the following installed on the client: <ul style="list-style-type: none"> • JVM (J2SE) 1.4.2 or higher • JRE (J2SE) 5.0 or higher
	Still image	Displays still images only. Hit the Refresh button in your browser to view a new image.
Other browsers	Server Push	Recommended viewer for other browsers (Motion JPEG).
	QuickTime	MPEG-4 only.
	Java applet	A slower imaging alternative to Server Push (Motion JPEG only).
	Still image	Displays still images only. Hit the Refresh button in your browser to view a new image.

Viewer Settings

Show viewer toolbar - Check this box to display e.g. the AXIS Media Control (AMC) or the QuickTime viewer toolbar under the video image in your browser.

Enable MPEG-4 decoder installation - The administrator can disable the installation of the MPEG-4 decoder included with AMC. This is used to prevent the installation of unlicensed copies. Further decoder licenses can be purchased from your Axis dealer.

Enable recording button - This will display the button for starting MPEG-4 recordings directly from the Live View page.

Event Configuration

An event in the camera is when an **Event Type** is activated and causes certain actions to be performed. The event type is the set of parameters (or conditions) that specifies how and when which actions will be performed. A common event type is when the camera uploads images when an alarm occurs. Many event types use an **Event Server** to receive uploaded images.

This section describes how to set up event servers and event types, i.e. how to configure the camera to perform certain actions when events (e.g. alarms) occur.

Definitions

Event type	A set of parameters describing how and when the camera will perform certain actions	
Triggered Event – see page 17	The circumstances that start an event.	E.g. on a signal from an external device, such as a door switch or a motion sensor.
Scheduled Event – see page 18	The circumstances that start an event.	E.g. at a pre-programmed time.
Action	What occurs when the event triggers.	E.g. the upload of images to an FTP server, e-mail notification, etc.

Event Servers

Event Servers are used to receive e.g. uploaded image files and/or notification messages. To set up Event server connections in your camera, go to **Setup > Event Configuration > Event Servers** and enter the required information for the required server type.

Server type	Purpose	Information required
FTP Server	<ul style="list-style-type: none"> Receives uploaded images 	<ul style="list-style-type: none"> Descriptive name of your choice Network address (IP address or host name) User Name and Password (for FTP server) Upload path e.g. images/ Port number Use passive mode if there is a firewall between the camera and FTP server Use temporary file if your FTP server doesn't allow an existing file to be overwritten by a new file with the same name
HTTP Server	<ul style="list-style-type: none"> Receives notification messages Receives uploaded images 	<ul style="list-style-type: none"> Descriptive name of your choice URL (IP address or host name) User Name and Password (for HTTP server) Proxy address/Proxy port (if required) Proxy User Name and Password (if required)
TCP Server	<ul style="list-style-type: none"> Receives notification messages 	<ul style="list-style-type: none"> Descriptive name of your choice Network address (IP address or host name) Port number

For details on each setting, please see the online help  available from each web page.

When the setup is complete, the connection can be tested by clicking the **Test** button (the connection test takes approximately 10 seconds).

Event Types

An **Event Type** describes how and when the camera will perform certain actions.

Example: If somebody passes in front of the camera and an event that uses motion detection has been configured to act on this, the camera can e.g. record and save images to an FTP server, and/or send a notification e-mail to a pre-configured e-mail address with a pre-configured message. Images can be sent as e-mail attachments.

Event Types

Event Type List					
Name	Status	Enabl.	Priority	Trig./Sched.	Actions*
Main Door	Active	Yes	Normal	Input ports	Fu
New Event	Inactive	Yes	Normal	Time frame	En
Server Room	Inactive	Yes	Normal	Motion det.	Hu

*Fu=FTP upload, Hu=HTTP upload, Eu=Email upload, O=Output port, En=Email notification, Hn=HTTP notification, Tn=TCP notification.

Triggered Events

A Triggered event can be activated by:

- a manual trigger from an action button in the web interface, or by a trigger sent via the AXIS VAPIX API
- detected movement in a configured motion detection window
- on restart (boot) after e.g. power loss
- a temperature alarm
- a camera tampering alarm

How to set up a triggered event

This example describes how to set up the camera to upload images when e.g. there is movement in the image:

1. Click **Add triggered** on the **Event types** page.
2. Enter a descriptive **name** for the event, e.g. *Movement*.
3. Set the **priority** - High, Normal or Low (see the online help).
4. Set the **Respond to Trigger...** parameters for when the event will be active, e.g. only after office hours.
5. Select the trigger alternative from the **Triggered by...** drop-down list, i.e. select **Motion detection**. Also select the required window and if the alarm should be triggered when motion starts or stops.
6. Set the **When Triggered...** parameters, i.e. define what the camera will do if there is an alarm, e.g. upload images to an FTP server or send an e-mail notification.
7. Click **OK** to save the Event in the Event Types list.

Please see the online help  for descriptions of each available option.

Note: Up to 10 event types can be configured in the camera, and up to 3 of these can be configured to upload images. Files names can be formatted according to specific requirements. See [File Naming & Date/Time Formats](#) online help.

Pre-trigger and Post-trigger buffers

This function is very useful when checking to see what happened immediately before and/or after a trigger, e.g. 30 seconds before and/or after the event. Check the **Upload images** checkbox under **Event Types > Add Triggered... > Triggered by...** to expand the web page with the available options. All uploaded images are JPEG images.

Include pre-trigger buffer - images stored internally in the server from the time immediately preceding the trigger. Check the box to enable the pre-trigger buffer, enter the desired length of time and specify the required image frequency.

Include post-trigger buffer - contains images from the time immediately after the trigger. Configure as for pre-trigger.

Notes:

- Pre-trigger and Post-trigger buffers will be lost if the connection to the event server fails.
- The maximum length of the pre-/post-buffer depends on the video image size and selected frame rate.
- If the pre- or post-buffer is too large for the camera's internal memory, the frame rate will be reduced and individual images may be missing. If this occurs, an entry will be created in the unit's log file.

Continue image upload (unbuffered) - enables the upload of video images for a fixed length of time. Specify the length of time for the uploaded recording, in seconds, minutes or hours, or for as long as the trigger is active. Finally, set the desired image frequency to the maximum (the maximum available) or to a specified frame rate. The frame rate will be the best possible, but might not be as high as specified, especially if uploading via a slow connection.

Scheduled Events

A **Scheduled** event can be activated at preset times, in a repeating pattern on selected days.

Configuration example:

1. Click **Add scheduled** on the **Event types** page.
2. Enter a descriptive **name** for the event, e.g. "Scheduled e-mail upload."
3. Set the **priority** (High, Normal or Low).
4. Set the **Activation Time** parameters (24h clock) when the event will be active, e.g. start on Sundays at 13.00 with a duration of 12 hours.
5. Set the **When Activated...** parameters, i.e. set what the camera will do at the specified time, e.g. send uploaded images to an e-mail address.
6. Click **OK** to save the Event in the Event Types list.

Please see the online help  for descriptions of each available option.

Camera Tampering

The camera tampering application generates an alarm whenever the camera is repositioned, or when the lens is covered, sprayed or severely defocused.

The settings available are:

Minimum duration - This sets the minimum tampering period, i.e., an alarm will not be triggered until this period has elapsed, even if the tampering conditions are otherwise met. This can help prevent false alarms for known conditions that affect the image.

Alarm for dark images - If the camera lens is sprayed and the image is darkened, it will not be possible to distinguish this from other situations where the same effect is seen, i.e. when the lighting conditions change. When this is enabled, alarms will be generated for all cases where the image turns dark or the lens is sprayed.

Motion Detection

Motion detection is used to generate an alarm whenever movement occurs (or stops) in the video image. A total of 10 Include and/or Exclude windows can be configured.

- **Included** windows target specific areas within the whole video image
- **Excluded** windows define areas within an Include window that should be ignored (areas outside Include windows are automatically ignored)

Once configured, the motion detection windows will appear in the list of available triggers, for triggering events. See *How to set up a triggered event* above.

Note: Using the motion detection feature may decrease the camera's overall performance.

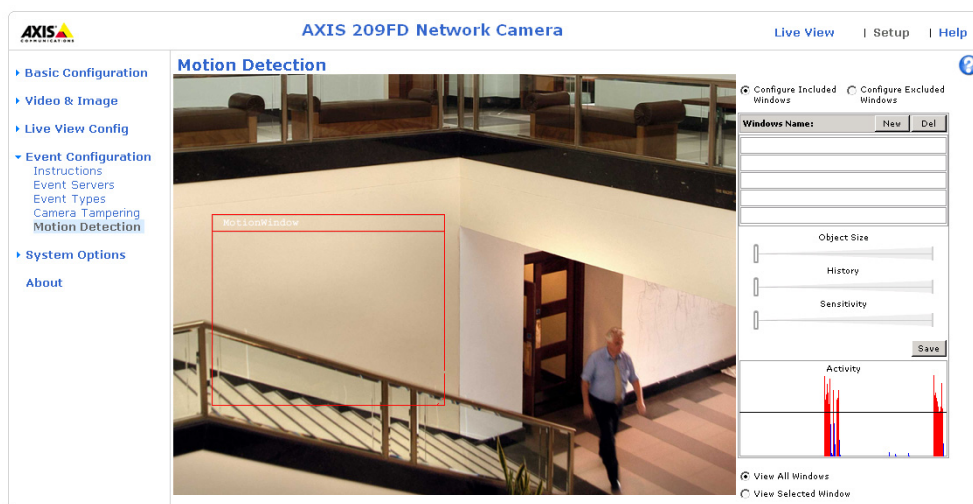

Configuring Motion Detection

1. Click **Motion Detection** in the **Event Configuration** menu.
2. Click the **Configure Included Window** radio button and click **New**.
3. Enter a descriptive name under **Window name**.
4. Adjust the size (drag the bottom right-hand corner) and position (click on the text at the top and drag to the desired position).
5. Adjust the **Object size**, **History** and **Sensitivity** profile sliders (see table below for details). Any detected motion within an active window is then indicated by red peaks in the **Activity** window (the active window has a red frame).
6. Click **Save**.

To exclude parts of the Include window, click the **Configure Excluded Windows** button and position the Exclude window as required, within the Include window.

Please see the online help [?](#) for descriptions of each available option.

	Object Size	History	Sensitivity
High level	Only very large objects trigger motion detection	An object that appears in the region will trigger the motion detection for a long period	Ordinary colored objects on ordinary backgrounds will trigger the motion detection
Low level	Even very small objects trigger motion detection	An object that appears in the region will trigger motion detection for only a very short period	Only very bright objects on a dark background will trigger motion detection
Default value	Low	Medium to High	Medium to High

Examples:

- Avoid triggering on small objects in the video image by setting the **object size** level to high.
- To reduce the number of triggers if there is a lot of movement during a short period of time, select a high **history** level.
- To only detect flashing light, low **sensitivity** can be selected. In other cases, a high **sensitivity** level is recommended.

System Options

Security

User access control is enabled by default. An administrator can set up other new users, by giving them user names and passwords. It is also possible to allow anonymous viewer login, which means that anybody may access the Live View page, as described below:

Users - the user list displays the authorized users and user groups (levels):

Viewer	Provides the lowest level of access, which only allows access to the Live View page.
Operator	An Operator can view the Live View page, create and modify events and adjust certain other settings. Operators have no access to the System Options.
Administrator	An administrator has unrestricted access to the Setup Tools and can determine the registration of all other users.

User Settings - check the relevant checkboxes to enable:

- **Anonymous viewer login** - allows any viewer direct access to the Live View page.
- **Maximum number of simultaneous viewers** - enter a value here to restrict the number of Motion JPEG and MPEG-4 viewers accessing the unit. This is useful if you need to save on bandwidth. Note that within the limit of 20 users, all multicast viewers count as 1 viewer.

IP Address Filtering

Enable IP Address Filtering to allow or deny access to the AXIS 209FD-R. Once enabled, the IP addresses in the list will be allowed or denied access according to the choice made in the drop-down list **Allow/Deny** the following IP addresses.

The administrator can add up to 256 IP address entries to the list (a single entry can contain multiple IP addresses). The users from these IP addresses need to be specified in the user list with the appropriate access rights. This is done from **Setup > System Options > Security > Users**.

Referrals

To prevent unauthorized clients from including the video stream from the cameras into external Web pages, check the **Referrals** checkbox and enter the IP address or Host name of the computer that hosts the Web pages with the included video stream. Several IP addresses/host names can be defined and are separated by semicolons (;). This option is only applicable to Motion JPEG video streams.

- Notes:**
- If the referrals feature is enabled and you wish to also allow normal access to the Live View page, the product's own IP address or host name must be added to the list of allowed referrers.
 - Restricting referrers has no effect on an MPEG-4 video stream. To restrict an MPEG-4 stream, IP address filtering must be enabled.
 - Restricting referrers is of greatest value when not using IP address filtering. If IP address filtering is used, then the allowed referrers are automatically restricted to those allowed IP addresses.

HTTPS

The AXIS 209FD-R supports encrypted browsing using HTTPS.

A **self-signed certificate** can be used until a Certificate Authority-issued certificate has been obtained. Click the **Create self-signed Certificate** button to install a self-signed certificate. Although self-signed certificates are free and offer some protection, true security will only be implemented after the installation of a signed certificate issued by a certificate authority.

A signed certificate can be obtained from an issuing Certificate Authority by clicking the **Create Certificate Request** button. When the signed certificate is returned, click the **Install signed certificate** button to import the certificate. The properties of any certificate request currently resident in the camera or installed can also be viewed by clicking the **Properties...** button. The HTTPS Connection Policy must also be set in the drop-down lists to enable HTTPS in the camera. For more information, please refer to the online help. 

Date & Time

Current Server Time - displays the current date and time (24h clock). The time can be displayed in 12h clock format in the Overlay (see below).

New Server Time - Select your time zone from the drop-down list. If you want the server clock to automatically adjust for daylight savings time, select the **Automatically adjust for daylight saving time changes**.

From the **Time Mode** section, select the preferred method to use for setting the time:

- **Synchronize with computer time** - sets the time from the clock on your computer.
- **Synchronize with NTP Server** - the camera will obtain the time from an NTP server every 60 minutes.
- **Set manually** - this option allows you to manually set the time and date.

Note: If using a host name for the NTP server, a DNS server must be configured under **TCP/IP** settings. See **Network > TCP/IP** below.

Date & Time Format Used in Images - specify the formats for the date and time (12h or 24h) displayed in the video streams.

Use the predefined formats or use your own custom date and time formats. See **Advanced File Naming & Date/Time Formats** in the online help for information on how to create your own file formats.

Network - Basic TCP/IP Settings

IP Address Configuration

The AXIS 209FD-R supports both IP version 4 and IP version 6. Both versions may be enabled simultaneously, and at least one version must always be enabled.

When using IPv4, the IP address for the camera can be set automatically via DHCP, or a static IP address can be set manually.

If IPv6 is enabled, the AXIS 209FD-R will receive an IP address according to the configuration in the network router.

There are also options for setting up notification of changes in the IP address, and for using the AXIS Internet Dynamic DNS Service. For more information on setting the IP address, please see the online help.

- Notes:**
- DHCP is a protocol for automatic IP address assignment on a network. IP address assignment via DHCP may lead to the situation where the IP address changes and you lose contact with the camera. Configure the options for notification of IP address change (under **Services**) to receive notification from the camera when the IP address changes.
 - Alternatively, if your DHCP server can update a DNS server, you can access the AXIS 209FD-R by host name which is always the same, regardless of the IP address.

Services

Enable ARP/Ping setting of IP address - The IP address can be set using the ARP/Ping method, which associates the unit's MAC address with an IP address. Check this box to enable the service. Leave disabled to prevent unintentional resetting of the IP address.

- Notes:**
- The ARP/Ping service is automatically disabled 2 minutes after the unit is started, or as soon as an IP address is set.
 - Pinging the unit will still be possible when this service is disabled.

Options for notification of IP address change - If the IP address for the camera changes, e.g. automatically by DHCP, you can choose to be notified of the change. Click **Settings...** and enter the required information.

AXIS Internet Dynamic DNS Service - Use the AXIS Internet Dynamic DNS service to assign a host name for easy access to your AXIS 209FD-R (requires Internet access).

Click **Settings...** to register the camera with the Axis Internet Dynamic DNS service, or to modify the existing settings (requires access to the Internet). The domain name currently registered at the Axis Internet Dynamic DNS service for your product can at any time be removed.

For more information, please refer to the online help.

Network - Advanced TCP/IP Settings

DNS Configuration

DNS (Domain Name Service) provides the translation of host names to IP addresses on your network.

Obtain DNS server address via DHCP - automatically use the DNS server settings provided by the DHCP server. Click the **View** button to see the current settings.

Use the following DNS server address - enter the desired DNS server by specifying the following:

Domain name - enter the domain(s) to search for the host name used by the AXIS 209FD-R. Multiple domains can be separated by semicolons (;). The host name is always the first part of a Fully Qualified Domain Name, e.g. **myserver** is the host name in the Fully Qualified Domain Name **myserver.mycompany.com** where **mycompany.com** is the Domain name.

DNS servers - enter the IP addresses of the primary and secondary DNS servers.

NTP Configuration

Obtain NTP server address via DHCP - check this radio button to automatically look up and use the NTP server settings as provided by DHCP. Click the **View** button to see the current settings.

Use the following NTP server address - to make manual settings, check this radio button and enter the host name or IP address of the NTP server.

Host Name Configuration

The AXIS 209FD-R can be accessed using a host name, instead of an IP address. The host name is usually the same as the assigned DNS Name.

For more information, please see the *Security* help.

Link-Local IPv4 Address

This is enabled by default and assigns the AXIS 209FD-R an additional IP address for use with UPnP™. The camera can have both a Link-Local IP and a static/DHCP-supplied IP address at the same time - these will not affect each other.

HTTP

The default HTTP port number (80) can be changed to any port within the range 1024-65535. This is useful for e.g. simple security port mapping.

HTTPS

The HTTPS port to use. The default setting is 443.

NAT traversal (port mapping) for IPv4

A broadband router allows devices on a private network (LAN) to share a single connection to the Internet. This is done by forwarding network traffic from the private network to the "outside" i.e. the Internet. Security on the private network (LAN) is increased since most broadband routers are pre-configured to stop any attempts to access the private network (LAN) from the public network/Internet.

Use **NAT traversal** when your AXIS 209FD-R is located on an intranet (LAN) and you wish to make it available from the other (WAN) side of a NAT router. With NAT traversal properly configured, all HTTP traffic to an external HTTP port in the NAT router will be forwarded to the camera.

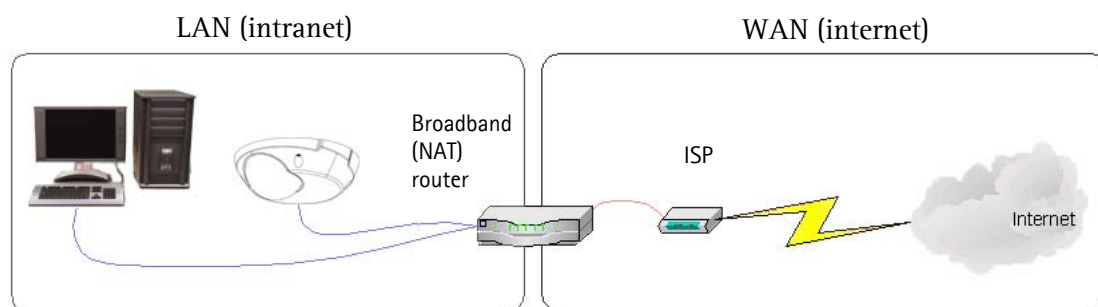

- Notes:**
- For NAT traversal to work, this must also be supported by the broadband router.
 - The broadband router has many different names: "NAT router", "Network router", "Internet Gateway", "Broadband sharing device" or "Home firewall" but the essential purpose of the device is the same.

Enable/Disable - When enabled, the AXIS 209FD-R will attempt to configure port mapping in a NAT router on your network, using UPnP™. Note that UPnP™ must be enabled in the camera (see **System Options > Network > UPnP**).

Use manually selected NAT router - Select this option to manually select a NAT router and enter the IP address for the router in the field provided.

If a router is not manually specified, the AXIS 209FD-R will automatically search for NAT routers on your network. If more than one router is found, the default router will be selected.

Alternative HTTP port - Select this option to manually define an external HTTP port. Enter the port number in the field provided. If no port is entered here a port number will automatically be selected when NAT traversal is enabled.

- Notes:**
- An alternative HTTP port can be used/be active even if NAT traversal is disabled. This is useful if e.g. your NAT router does not support UPnP and you need to manually configure port forwarding in the NAT router.
 - If you attempt to manually enter a port that is already in use, another available port will automatically be selected.
 - When the port is selected automatically it will be displayed in this field. This can be changed by entering a new port number and clicking Save.

FTP

The FTP server running in the AXIS 209FD-R enables the upload of e.g. new firmware, user applications, etc. Check the box to enable the service.

RTSP

The RTSP protocol allows a connecting client to start an MPEG-4 stream. Check the box to enable the server and enter the RTSP port number to use. The default setting is 554. Note that MPEG-4 video streams will not be available if this service is not enabled.

Network Traffic

Connection Type - The default setting is Auto-negotiate, which means that the correct speed is automatically selected. If necessary, you can set the connection speed by selecting it from the drop-down list.

Maximum bandwidth - To minimize the impact on other services running on your network, it is possible to configure the maximum network bandwidth the product will be allowed to use. Specify the maximum bandwidth (in Mbit/s or kbit/s) allowed, or set to *Unlimited*.

SOCKS

SOCKS is a networking proxy protocol. The AXIS 209FD-R can be configured to use a SOCKS server to reach networks on the other side of a firewall/proxy server. This functionality is useful if the camera is located on a local network behind a firewall, but notifications, uploads, alarms, etc., need to be sent to a destination outside the local network (e.g. to the Internet).

QoS (Quality of service)

Quality of Service (QoS) provides the means to guarantee a certain level of a specified resource to selected traffic on a network. Quality can be defined as e.g. a maintained level of bandwidth, low latency, no packet losses, etc. The main benefits of a QoS-aware network can be summarized as:

- The ability to prioritize traffic and thus allow critical flows to be served before flows with lesser priority.
- Greater reliability in the network, thanks to the control of the amount of bandwidth an application may use, and thus control over bandwidth races between applications.

The QoS in Axis network video products marks the data packets for various types of network traffic originating from the product. This makes it possible for network routers and switches to e.g. reserve a fixed amount of bandwidth for these types of traffic. The AXIS 209FD-R marks the following types of traffic:

- video
- event/alarm
- management network traffic.

QoS Settings

For each type of network traffic supported by your Axis network video product, enter a DSCP (Differentiated Services Codepoint) value. This value is used to mark the traffic's IP header. When the marked traffic reaches a network router or switch, the DSCP value in the IP header tells the router or switch which type of treatment to apply to this type of traffic, for example, how much bandwidth to reserve for it.

Note that DSCP values can be entered in decimal or hex form, but saved values are always shown in decimal.

For more information on Quality of Service, please see the Axis support web at www.axis.com/techsup

SMTP (email)

Enter the host names (or IP addresses) and port numbers for your primary and secondary mail servers in the fields provided, to enable the sending of notifications and image/video email messages from the camera to predefined addresses via SMTP.

If your mail server requires authentication, check the box for **Use authentication to log in to this server** and enter the necessary information.

SNMP

The Simple Network Management Protocol (SNMP) allows remote management of network devices. Depending on the level of security required, select the version of SNMP to use. The three levels of security are:

- SNMP V1 - includes no security.
- SNMP V2c - uses very simple security. The community name can be specified as a password for read or read/write access to all supported SNMP objects. The community is the the group of network devices using SNMP.
- SNMP V3 - provides encryption and secure passwords. HTTPS must be enabled.

UPnP™

The camera includes support for UPnP™, which is enabled by default. If also enabled on your computer, the camera will automatically be detected and a new icon will be added to “My Network Places.”

Note: UPnP must also be enabled on your Windows XP or ME computer. To do this, open the Control Panel from the **Start Menu** and select **Add/Remove Programs**. Select **Add/Remove Windows Components** and open the **Networking Services** section. Click **Details** and then select **UPnP** as the service to add.

RTP / MPEG-4

These settings are the port range, IP address, port number (video and audio), and Time-To-Live value to use for the video stream(s) in multicast MPEG-4 format. Only certain IP addresses and port numbers should be used for multicast streams. For more information, please see the online help.

Bonjour

The AXIS 209FD-R includes support for Bonjour. When enabled, the camera is automatically detected by operating systems and clients that support this.

LED Settings

The Status indicator LED on the camera can be set to flash at a configurable interval (or to not light up at all) whenever the unit is accessed. For a listing of all LED behavior, see page 6, or the online help. Note that the LED does not flash when the stream is retrieved using MPEG-4 multicast.

Maintenance

- **Restart** - The camera is restarted without changing any of the settings.
- **Restore** - The unit is restarted and most current settings are reset to factory default values. The settings that will not be reset are as follows:
 - the boot protocol (DHCP or static)
 - the static IP address
 - the default router
 - the subnet mask
- **Default** - The default button should be used with caution. Pressing this will return all of the camera's settings to the factory default values (including the IP address)

Upgrade Server - See *Upgrading the Firmware*, on page 27.

Backup - To take a backup of all of the parameters, and any user-defined scripts, click this button. If necessary, it will then be possible to return to the previous settings, if settings are changed and there is unexpected behavior.

Restore - click the **Browse** button to locate the saved backup file (see above) and then click the **Restore** button. The settings will be restored to the previous configuration.

Note: Backup and Restore can only be used on the same unit running the same firmware. This feature is not intended for the configuration of multiple units or for firmware upgrades.

Support

The **support overview** page provides valuable information on troubleshooting and contact information, should you require technical assistance.

System Overview - is a quick look over the camera's status and settings. Information that can be found here includes the camera's Firmware version, IP address, Security, Event and Image settings and Recent log items. Many of the captions are also links to the proper **Setup** page to conveniently make adjustments in the cameras settings.

Logs & Reports - when contacting Axis support, please be sure to provide a valid Server Report with your query.

View Information - The Log file, the Server Report and the Parameter List all provide valuable information for troubleshooting and when contacting Axis support.

Configuration

Log Level for Log Files - from the drop-down list, select the level of information to be added to the Log file

Log Level for Email - from the drop-down list, select the level of information to send as email and enter the destination email address.

Resetting to the Factory Default Settings

To reset the camera to the original factory default settings, go to the **System Options > Maintenance** web page (as described in *Maintenance*, on page 25) or use the **Control button**, which is found inside the camera cover (see page 5) as described below:

Using the Control Button

To reset the camera to the factory default settings using the Control Button:

1. Remove the camera's cover.
2. Disconnect the network to remove power.
3. Press and hold the Control button while reconnecting the cable.
4. Keep the Control button pressed until the **Status Indicator** color changes to amber (this may take up to 15 seconds).
5. Release the Control button.
6. When the Status Indicator changes to Green (which may take up to 1 minute), the process is complete and the camera has been reset. The unit will now have the default IP address 192.168.0.90

Advanced

Scripting is an advanced function that provides the possibility to customize and use scripts. This function is a very powerful tool.

Caution!

Improper use may cause unexpected behavior or even cause loss of contact with the unit. If a script does cause problems, reset the unit to its factory default settings. A backup file may be of use to return the unit to its latest configuration.

Axis strongly recommends that you do not use this function unless you fully understand the consequences. Note that Axis support does not provide assistance for problems with customized scripts.

For more information, please visit the Video Developer pages at www.axis.com

Plain Config - this function is for the advanced user with experience of Axis network camera configuration. All parameters can be set and modified from this page. Help is available from the standard help pages.

Troubleshooting

Checking the Firmware

Firmware is software that determines the functionality of the AXIS 209FD-R. One of your first actions when troubleshooting a problem should be to check the currently installed firmware version. The latest version may contain a correction that fixes your particular problem. The current firmware version in your camera can be seen on the page **Setup > Basic Configuration**.

Upgrading the Firmware

When you upgrade the firmware with a file from the Axis Web site, your camera will receive the latest available functionality. Always read the upgrade instructions and release notes available with each new release, before updating the firmware.

Note: Pre-configured and customized settings will be saved when the firmware is upgraded (providing the same features are available in the new firmware) although this is not guaranteed by Axis Communications. Always read the instructions and release notes provided with each new release, before upgrading the firmware.

1. Save the firmware file to your computer. The latest version of the firmware is available free of charge from the Axis Web site at www.axis.com/techsup
2. Go to **Setup > System Options > Maintenance** in the camera's Web pages.
3. In the **Upgrade Server** section, browse to the desired firmware file on your computer. Click **Upgrade**.

Notes:

- After starting the upgrade process, always wait at least 5-10 minutes before restarting the camera, even if you suspect the upgrade has failed.
- Your dealer reserves the right to charge for any repair attributable to faulty upgrading by the user.
- The **AXIS Camera Management** software tool can be used for multiple upgrades. Please see the Axis Web site at www.axis.com for more information.

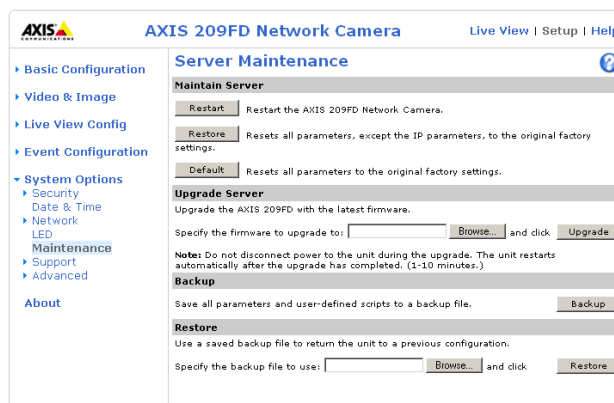

Emergency Recovery Procedure

If the power/network connection to the camera is lost during the upgrade, the process will fail and the unit will become unresponsive. A flashing red Status LED indicates a failed upgrade. To recover the unit, follow the steps below. The serial number is found on the label inside the camera cover.

1. **Unix/Linux** - From the command line, type the following:

```
arp -s <IP address of camera> <Serial number> temp
ping -s 408 <IP address of camera>
```

Windows - From a command/DOS prompt, type the following:

```
arp -s <IP address of camera> <Serial number>
ping -l 408 -t <IP address of camera>
```

2. If the unit does not reply within a few seconds, restart it and wait for a reply. Press CTRL+C to stop Ping.
3. Open a browser and type in the camera's IP address. In the page that appears, use the **Browse** button to select the upgrade file to use, e.g. axis209fdr.bin. Then click the **Load** button to restart the upgrade process.

4. After the upgrade has completed (1-10 minutes), the unit will automatically restart and show a steady green on the Power and Status LEDs and flashing green or amber on the Network LED.
5. Referring to the installation guide, reinstall the camera.

If the emergency recovery procedure does not get the camera up and running again, please contact Axis support at www.axis.com/techsup/

Axis Support

If you contact Axis support, please help us to help you solve your problems, by providing the server report, the log file and a detailed description of the problem.

Server Report - go to **Setup > System Options > Support Overview**. The server report contains important information about the server and its software, as well as a list of the current parameters.

The **Log file** is available from **Setup > System Options > Logs & Reports**. The Log file records events in the unit since the last system restart and can be a useful diagnostic tool when troubleshooting.

Symptoms, Possible Causes and Remedial Actions

Problems setting the IP address	
When using ARP/Ping	Try the installation again. The IP address must be set within two minutes after power has been applied to the camera. Ensure the Ping length is set to 408. See the Installation Guide.
The camera is located on a different subnet	If the IP address intended for the camera and the IP address of your computer are located on different subnets, you will not be able to set the IP address. Contact your network administrator to obtain an appropriate IP address.
The IP address is being used by another device	Disconnect the camera from the network. Run the Ping command. (In a Command/DOS window, type ping and the IP address of the unit). If you receive: Reply from <IP address>: bytes = 32; time = 10 ms..... - this means that the IP address may already be in use by another device on your network. You must obtain a new IP address and reinstall the unit. If you see: Request timed out - this means that the IP address is available for use with your camera. In this case, check all cabling and reinstall the unit.
Possible IP address conflict with another device on the same subnet	The static IP address in the camera is used before the DHCP server sets a dynamic address. This means that if the same default static IP address is also used by another device, there may be problems accessing the camera. To avoid this, set the static IP address to 0.0.0.0.
The camera cannot be accessed from a browser	
The IP address has been changed by DHCP	1) Move the camera to an isolated network or to one with no DHCP or BOOTP server. Set the IP address again, using the AXIS IP Utility (see the Installation Guide) or the ARP/Ping commands. 2) Access the unit and disable DHCP in the TCP/IP settings. Return the unit to the main network. The unit now has a fixed IP address that will not change. 3) As an alternative to 2), if a dynamic IP address via DHCP or BOOTP is required, select the required service and then configure IP address change notification from the network settings. Return the unit to the main network. The unit will now have a dynamic IP address, but will notify you if the address changes.
Other networking problems	Test the network cable by connecting it to another network device, then Ping that device from your workstation. See the instructions above.
Camera is accessible locally, but not externally	
Broadband router configuration	To configure your broadband router to allow incoming data traffic to the camera: Enable the NAT-traversal feature, which will attempt to automatically configure the router to allow access to the camera. This is enabled from Setup > System Options > Network > TCP/IP Advanced. Note that if your router does not support NAT traversal, it is recommended that port forwarding is configured manually instead. To do this, set a static IP address for the camera, and set the router to allow HTTP traffic to the camera's IP address and HTTP port. Note that the default HTTP port (80) may already be used by the router itself (for remote administration), so changing the HTTP port for the camera (to e.g. 8000) is recommended.
Firewall protection	Check the Internet firewall with your system administrator.
Default routers required	Check if you need to configure the default router settings.
Problems with the MPEG-4 format	
No MPEG-4 displayed in the client	Check that the correct network interface is selected in the AMC control panel applet (network tab). Check that the relevant MPEG-4 connection methods are enabled in the AMC control panel applet (network tab). In the AMC control applet, select the MPEG-4 tab and click the button Set to default MPEG-4 decoder.
No multicast MPEG-4 displayed in the client	Check with your network administrator that the multicast addresses used by the camera are valid for your network. Check with your network administrator to see if there is a firewall preventing viewing.
Multicast MPEG-4 only accessible by local clients	Check if your router supports multicasting, or if the router settings between the client and the server need to be configured. The TTL (Time To Live) value may need to be increased.
Poor rendering of MPEG-4 images	Color depth set incorrectly on clients. Set to 16-bit or 32-bit color. If text overlays are blurred, or if there are other rendering problems, you may need to enable Advanced Video Rendering from the MPEG-4 tab in the AMC control panel applet. Ensure that your graphics card is using the latest device driver. The latest drivers can usually be downloaded from the manufacturer's web site.
Color saturation is different in MPEG-4 and Motion JPEG	Modify the settings for your graphics adapter. Please see the adapter's documentation for more information.
Lower frame rate than expected	Reduce number of applications running on the client computer. Limit the number of simultaneous viewers. This is done in System Options > Security > Users. Check with the system administrator that there is enough bandwidth available. See also the online help. Check in the AMC control panel applet (MPEG-4 tab) that video processing is not set to Decode only I frames. Lower the image resolution.
Why do I not get 30 frames per second?	See the section <i>General performance considerations</i> , on page 33.
Lost or poor images in pre-trigger buffer (MPEG-4 video stream)	Make sure that Cyclic refresh under Setup > Video & Image > Advanced > MPEG-4 is disabled.
Image degeneration	Decrease the GOV length, see the online help for more information.
The Status and Network indicator LEDs are flashing red rapidly	
Hardware failure	Contact your Axis dealer.
The Status indicator LED is flashing red and the camera is inaccessible	

A firmware upgrade has been interrupted or the firmware has otherwise been damaged	See the <i>Emergency Recovery Procedure</i> above.
No images displayed on web page	
Problem with AMC. (<i>Internet Explorer only</i>)	To enable the updating of video images in Microsoft Internet Explorer, set your browser to allow ActiveX controls. Also, make sure that AXIS Media Control (AMC) component is installed on your workstation.
Installation of additional ActiveX component restricted or prohibited	Configure your camera to use a Java applet for updating the video images under Live View Config > Layout > Default Viewer for Internet Explorer. See the online help for more information.
Video/Image problems, general	
Image too dark or too light	Check the video image settings. See the online help on Video and Image Settings.
Missing images in uploads	This can occur when trying to use a larger image buffer than is actually available. Try lowering the frame rate or the upload period.
Slow image update	Configuring, e.g. pre-buffers, motion detection, high-resolution images, high frame rates, etc, will reduce the performance of the camera.
Poor performance	Poor performance may be caused by e.g. heavy network traffic, multiple users accessing the unit, low performance clients, use of features such as motion detection or event handling.
Poor quality snapshot images	
Screen incorrectly configured on your workstation	In Display Properties, configure your screen to show at least 65000 colors, i.e. at least 16-bit. Using only 16 or 256 colors will produce dithering artifacts in the image.
Browser freezes	
Netscape 7.x or Mozilla 1.4 (or later) can sometimes freeze on a slow computer	Lower the image resolution.
Motion Detection triggers unexpectedly	
Changes in luminance	Motion detection is based upon changes in luminance in the image. This means that if there are sudden changes in the lighting, motion detection may be triggered mistakenly. Lower the sensitivity setting to avoid problems with luminance.

For further assistance, please contact your reseller or see the support pages on the Axis Website at www.axis.com/techsup

Technical Specifications

Item	Specification
Image sensor	1/4" Progressive scan RGB VGA CMOS
Lens	<ul style="list-style-type: none"> • 3.0mm, F2.0 • Fixed iris • Focus range: 0.5m to infinity
Angle of view	<ul style="list-style-type: none"> • Horizontal: 66°
Camera angle adjustment	<ul style="list-style-type: none"> • Tilt: 0-90° • Pan: ±10° • Rotation: ±10°
Illumination	1.5-10000 lux, F2.0
Video compression	<ul style="list-style-type: none"> • Motion JPEG • MPEG-4 Part 2 (ISO/IEC 14496-2) with motion estimation • Profiles (MPEG-4): Simple Profile level 0-3 and Advanced Simple Profile level 0-5
Resolutions	<ul style="list-style-type: none"> • 9 resolutions from 640x480 to 160x120 via API • 6 selections via configuration web page
Frame rate	Up to 30 fps in all resolutions (Motion JPEG or MPEG-4)
Video streaming	<ul style="list-style-type: none"> • Simultaneous Motion JPEG and MPEG-4 • Controllable frame rate and bandwidth • Constant and variable bit rate (MPEG-4)
Image settings	<ul style="list-style-type: none"> • Compression levels: 100 • Rotation: 0°, 180° • Configurable color level, brightness, sharpness, contrast, white balance, exposure control • Overlay capabilities: time, date, text, image or privacy mask
Shutter time	1/4 s to 1/10000 s
Security	<ul style="list-style-type: none"> • Multiple user access levels with password protection • IP address filtering • HTTPS encryption
Users	<ul style="list-style-type: none"> • 20 simultaneous users • Unlimited number of users using multicast (MPEG-4)
Alarm and event management	<ul style="list-style-type: none"> • Events triggered by built-in multi-window motion detection, tampering alarm or according to a schedule • Image upload over FTP, email and HTTP • Notification over TCP, email and HTTP • Pre- and post alarm buffer of 9 MB (approx. 5 min of 320x240 resolution video at 4 fps)
Connectors	Female RJ-45 industrial connector, compatible with Woodhead RJ-Lnxx IP67 connectors
Casing	<ul style="list-style-type: none"> • Polycarbonate base and polycarbonate dome • Tamper-proof mounting
Processors, memory, clock	<ul style="list-style-type: none"> • CPU, video processing and compression: ARTPEC-A • RAM: 32 MB • Flash memory: 8 MB
Power	Power over Ethernet (IEEE 802.3af) with power classification: Class 1 (max 3.84 W)
Operating conditions	<ul style="list-style-type: none"> • Temperature: 0 to +50 °C (32-122 °F), IP66 • Vibration: ISO16750-3
Installation, management and maintenance	<ul style="list-style-type: none"> • AXIS Camera Management tool on CD and web-based configuration • Configuration of backup and restore • Firmware upgrades over HTTP or FTP, firmware available at www.axis.com
Video access from Web browser	<ul style="list-style-type: none"> • Camera live view • Video recording to file (ASF)
Minimum web browsing requirements	<ul style="list-style-type: none"> • Pentium III CPU 500 MHz or higher or equivalent AMD • 128 MB RAM • AGP graphics card, DirectDraw, 32 MB RAM • Windows XP, 2000 • DirectX 9.0 or later • Internet Explorer 6.x or later <p>For other operating systems and browsers, see www.axis.com/techsup</p>

Item	Specification
System integration support	<ul style="list-style-type: none"> • Powerful API for software integration, including AXIS VAPIX API*, AXIS Media Control SDK* • Event trigger data in video stream • Quality of Service (QoS) Layer 3, DiffServ Model • Embedded Linux operating system <p>* Available for download at www.axis.com</p>
Supported protocols	<p>IPv4/v6, HTTP, HTTPS, SSL/TLS*, TCP, ICMP, QoS, SNMPv1/v2c/v3 (MIB-II), RTSP, RTP, UDP, IGMP, RTCP, SMTP, FTP, DHCP, UPnP, Bonjour, ARP, DNS, DynDNS, SOCKS, NTP.</p> <p>More information on protocol usage available at www.axis.com</p> <p>* This product includes software developed by the Open SSL Project for use in the Open SSL Tool kit (www.openssl.org)</p>
Included accessories	<ul style="list-style-type: none"> • Single pack: AXIS PoE Midspan 1-port, Anti-theft key, Silica gel bag, Installation Guide, CD with installation tool, software and User's Manual, MPEG-4 licenses (1 encoder,1 decoder), MPEG-4 decoder (Windows) • 10-pack: Anti-theft key, 10 Silica gel bags, Installation Guide, CD with installation tool, software and User's Manual, MPEG-4 licenses (1 encoder, 1 decoder per camera), MPEG-4 decoder (Windows) • 50-pack: Anti-theft key, 50 Silica gel bags, MPEG-4 licenses (1 encoder, 1 decoder per camera), MPEG-4 decoder (Windows)
Video management software (not included)	<p>AXIS Camera Station: Surveillance application for viewing, recording and archiving up to 25 cameras</p> <p>See www.axis.com/partner/adp_partners.htm for further software applications from partners.</p>
Accessories (not included)	<ul style="list-style-type: none"> • Spare top covers (10-pack) • Extra silica gel bags (100-pack) • AXIS MPEG-4 Decoder multi-user license pack
Approvals	<ul style="list-style-type: none"> • CE: Automotive environment • EN60950, IP66, ISO16750-3
Dimensions (HxWxD) & weight	<ul style="list-style-type: none"> • 39 x 102 x 100 mm (1.5" x 4.0" x 3.9") • Weight: 0.18kg (0.40lb)

General performance considerations

When setting up your system, it is important to consider how various settings and situations will affect performance. Some factors affect the amount of bandwidth (the bit rate) required, others can affect the frame rate, and some will affect both. If the load on the CPU reaches its maximum, this will also affect the frame rate.

The following factors are among the most important to consider:

- High image resolutions and/or lower compression levels result in larger images. Bandwidth affected.
- Access by large numbers of Motion JPEG and/or unicast MPEG-4 clients. Bandwidth affected.
- Simultaneous viewing of different streams (resolution, compression, etc.) by different clients. Frame rate and bandwidth affected.
- Accessing both Motion JPEG and MPEG-4 video streams simultaneously. Frame rate and bandwidth affected.
- Heavy usage of event settings affects the camera’s CPU load. Frame rate affected.
- Enabled motion detection. Frame rate and bandwidth affected.
- Heavy network utilization due to poor infrastructure. Bandwidth affected
- Viewing on poorly performing client PC’s lowers perceived performance. Frame rate affected.

Optimizing your system

To see the bandwidth and frame rate currently required by the video stream, the AXIS 209FD-R provides a tool that can be used to display these values directly in the video image.

To do this, special format strings are added as part of a text overlay. Simply add **#r** (average frame rate in fps) and/or **#b** (average bandwidth in kbps) to the overlay.

For detailed instructions, please see the online help for **Video & Image > Text Overlay Settings**, and the help for **File Naming & Date/Time Formats**.



Important!

- The figures displayed here are the values as delivered by the camera. If other restrictions are currently in force, (e.g. bandwidth limitation) these values might not correspond to those actually received by the client.
- For Motion JPEG, these values will be accurate as long as no frame rate limit has been specified.

Bandwidth

As there are many factors that affect bandwidth, it is very difficult to predict the required amounts. The settings that affect bandwidth are:

- image resolution
- image compression
- frame rate
- MPEG-4 GOV settings
- bit rate control settings

There are also factors in the monitored scene that will affect the bandwidth. These are:

- amount of motion
- image complexity
- lighting conditions

For MPEG-4, if there is only limited bandwidth available, and if this is more important than the image quality, using a constant bit rate (CBR) is recommended. Use a variable bit rate (VBR) if the image quality needs to be maintained at a higher level. If supported on the network, consider also using MPEG-4 multicasting, as the bandwidth consumption will be much lower.

Glossary of Terms

ActiveX - A standard that enables software components to interact with one another in a networked environment, regardless of the language(s) used to create them. Web browsers may come into contact with ActiveX controls, ActiveX documents, and ActiveX scripts. ActiveX controls are often downloaded and installed automatically as required.

AF (Autofocus) - A system by which the camera lens automatically focuses on a selected part of the subject.

Angle - The field of view, relative to a standard lens in a 35mm still camera, expressed in degrees, e.g. 30°. For practical purposes, this is the area that a lens can cover, where the angle of view is determined by the focal length of the lens. A wide-angle lens has a short focal length and covers a wider angle of view than standard or telephoto lenses, which have longer focal lengths.

ARP (Address Resolution Protocol) - This protocol is used to associate an IP address to a hardware MAC address. A request is broadcast on the local network to discover the MAC address for an IP address.

ARTPEC (Axis Real Time Picture Encoder) - This chip is used for image compression.

ASIC (Application Specific Integrated Circuit) - A circuit designed for a specific application, as opposed to a general purpose circuit, such as a microprocessor.

Aspect ratio - A ratio of width to height in images. A common aspect ratio used for television screens and computer monitors is 4:3. High-definition television (HDTV) uses an aspect ratio of 9:16.

Autoiris (or DC-Iris) - This special type of iris is electrically controlled by the camera, to automatically regulate the amount of light allowed to enter.

AVI (Audio Video Interleave) - A video format that supports simultaneous playback of audio and video.

Bitmap - A bitmap is a data file representing a rectangular grid of pixels. It defines a display space and color for each pixel (or "bit") in the display space. This type of image is known as a "raster graphic." GIF's and JPEG's are examples of image file types that contain bitmaps.

Because a bitmap uses this fixed raster method, it cannot easily be rescaled without losing definition. Conversely, a vector graphic image uses geometrical shapes to represent the image, and can thus be quickly rescaled.

Bit rate - The bit rate (in kbit/s or Mbit/s) is often referred to as speed, but actually defines the number of bits/time unit and not distance/time unit.

Bluetooth - Bluetooth is an open standard for wireless transmission of voice and data between mobile devices (PCs, handheld computers, telephones and printers).

Bonjour - Also known as zero-configuration networking, Bonjour enables devices to automatically discover each other on a network, without having to enter IP addresses or configure DNS servers. Bonjour is a trademark of Apple Computer, Inc..

Broadband - In network engineering terms, this describes transmission methods where two or more signals share the same carrier. In more popular terminology, broadband is taken to mean high-speed data transmission.

CCD (Charged Coupled Device) - This light-sensitive image device used in many digital cameras is a large integrated circuit that contains hundreds of thousands of photo-sites (pixels) that convert light energy into electronic signals. Its size is measured diagonally and can be 1/4", 1/3", 1/2" or 2/3".

CGI (Common Gateway Interface) - A specification for communication between a web server and other (CGI) programs. For example, a HTML page that contains a form might use a CGI program to process the form data once it is submitted.

CIF (Common Intermediate Format) - CIF refers to the analog video

resolutions 352x288 pixels (PAL) and 352x240 pixels (NTSC). See also *Resolution*.

Client/Server - Client/server describes the relationship between two computer programs in which one program, the client, makes a service request from another program, the server, which fulfills the request. Typically, multiple client programs share the services of a common server program. A web browser is a client program that requests services (the sending of web pages or files) from a web server.

CMOS (Complementary Metal Oxide Semiconductor) - A CMOS is a widely used type of semiconductor that uses both negative and positive circuits. Since only one of the circuit types is on at any given time, CMOS chips require less power than chips using just one type of transistor. CMOS image sensors also allow processing circuits to be included on the same chip, an advantage not possible with CCD sensors, which are also much more expensive to produce.

Codec - In communications engineering, a codec is usually a coder/decoder. Codecs are used in integrated circuits or chips that convert e.g. analog video and audio signals into a digital format for transmission. The codec also converts received digital signals back into analog format. A codec uses analog-to-digital conversion and digital-to-analog conversion in the same chip.

Codec can also mean compression/decompression, in which case it is generally taken to mean an algorithm or computer program for reducing the size of large files and programs.

Compression - See *Image Compression*.

Contrast - Defines the degree of difference between the lightest and darkest parts of an image or video stream.

DC-Iris - This special type of iris is electrically controlled by the camera, to automatically regulate the amount of light allowed to enter.

DHCP (Dynamic Host Configuration Protocol) - DHCP is a protocol that lets network administrators automate and centrally manage the assignment of Internet Protocol (IP) addresses to network devices in a network.

DHCP uses the concept of a "lease" or amount of time that a given IP address will be valid for a computer. The lease time can vary, depending on how long a user is likely to require the network connection at a particular location.

DHCP also supports static addresses for e.g. computers running web servers, which need a permanent IP address.

DNS (Domain Name System) - DNS is used to locate and translate Internet domain names into IP (Internet Protocol) addresses. A domain name is a meaningful and easy-to-remember name for an Internet address. For example the domain name www.example.com is much easier to remember than 192.0.34.166. The translation tables for domain names are contained in Domain name servers.

Domain Server - Domains can also be used by organizations who wish to centralize the management of their (Windows) computers. Each user within a domain has an account that usually allows them to log in to and use any computer in the domain, although restrictions may also apply. The domain server is the server that authenticates the users on the network.

Duplex - See *Full-duplex*.

Ethernet - Ethernet is the most widely installed local area network technology. An Ethernet LAN typically uses special grades of twisted pair wires. The most commonly installed Ethernet systems are 10BASE-T and 100BASE-T10, which provide transmission speeds up to 10 Mbps and 100 Mbps respectively.

ETRAX (Ethernet Token Ring AXIS) - Axis' own microprocessor.

Factory default settings - These are the settings that originally applied for a device when it was first delivered from the factory. If it should become necessary to reset a device to its factory default settings, this will, for many devices, completely reset any settings that were changed by the user.

Firewall - A firewall works as a barrier between networks, e.g. between a Local Area Network and the Internet. The firewall ensures that only authorized users are allowed to access the one network from

the other. A firewall can be software running on a computer, or it can be a standalone hardware device.

Focal length - Measured in millimetres, the focal length of a camera lens determines the width of the horizontal field of view, which in turn is measured in degrees.

FTP (File Transfer Protocol) - An application protocol that uses the TCP/IP protocols. It is used to exchange files between computers/devices on networks.

Frame - A frame is a complete video image. In the 2:1 interlaced scanning format of the RS-170 and CCIR formats, a frame is made up of two separate fields of 262.5 or 312.5 lines interlaced at 60 or 50 Hz to form a complete frame, which appears at 30 or 25 Hz. In video cameras with a progressive scan, each frame is scanned line-by-line and not interlaced; most are also displayed at 30 and 25 Hz.

Frame rate - The frame rate used to describe the frequency at which a video stream is updated is measured in frames per second (fps). A higher frame rate is advantageous when there is movement in the video stream, as it maintains image quality throughout.

Full-duplex - Transmission of data in two directions simultaneously. In an audio system this would describe e.g. a telephone systems. Half-duplex also provides bi-directional communication, but only in one direction at a time, as in a walkie-talkie system. See also *Simplex*.

Gain - Gain is the amplification factor and the extent to which an analog amplifier boosts the strength of a signal. Amplification factors are usually expressed in terms of power. The decibel (dB) is the most common way of quantifying the gain of an amplifier.

Gateway - A gateway is a point in a network that acts as an entry point to another network. In a corporate network for example, a computer server acting as a gateway often also acts as a proxy server and a firewall server. A gateway is often associated with both a router, which knows where to direct a given packet of data that arrives at the gateway, and a switch, which furnishes the actual path in and out of the gateway for a given packet.

GIF (Graphics Interchange Format) - GIF is one of the most common file formats used for images in web pages. There are two versions of the format, 87a and 89a. Version 89a supports animations, i.e. a short sequence of images within a single GIF file. A GIF89a can also be specified for interlaced presentation.

GOV (Group Of VOPs) - A group of VOP's is the basic unit of an MPEG-4 video stream. The GOV contains different types and numbers of VOP's (I-VOP's, P-VOP's, etc) as determined by the GOV length and GOV structure. See also *VOP*.

GOV length - The GOV length determines the number of images (VOP's) in the GOV structure. See also *GOV* and *VOP*.

GOV structure - The GOV structure describes the composition of an MPEG-4 video stream, as regards the type of images (I-VOP's or P-VOP's) included in the stream, and their internal order. See also *GOV* and *VOP*.

Half-duplex - See *Full-duplex*.

HTML (Hypertext Markup Language) - HTML is the set of "markup" symbols or codes inserted in a file intended for display in web browser. The markup tells the browser how to display the page's words and images for the user.

HTTP (Hypertext Transfer Protocol) - HTTP is the set of rules for exchanging files (text, graphic images, sound, video, and other multimedia files) on the web. The HTTP protocol runs on top of the TCP/IP suite of protocols.

Hub - A (network) hub is used to connect multiple devices to the network. The hub transmits all data to all devices connected to it, whereas a switch will only transmit the data to the device it is specifically intended for.

IEEE 802.11 - A family of standards for wireless LANs. The 802.11 standard supports 1 or 2 Mbit/s transmission on the 2.4 GHz band. IEEE 802.11b specifies an 11 Mbit/s data rate on the 2.4 GHz band, while 802.11a allows up to 54 Mbit/s on the 5 GHz band.

Image compression - Image compression minimizes the file size (in bytes) of an image. Two of the most common compressed image

formats are JPEG and GIF.

Interlacing - Interlaced video is video captured at 50 pictures (known as fields) per second, of which every 2 consecutive fields (at half height) are then combined into 1 frame. Interlacing was developed many years ago for the analog TV world and is still used widely today. It provides good results when viewing motion in standard TV pictures, although there is always some degree of distortion in the image.

To view interlaced video on e.g. a computer monitor, the video must first be de-interlaced, to produce progressive video, which consists of complete images, one after the other, at 25 frames per second. See also *Progressive scan*.

IP (Internet Protocol) - The Internet Protocol is a method transmitting data over a network. Data to be sent is divided into individual and completely independent "packets." Each computer (or host) on the Internet has at least one address that uniquely identifies it from all others, and each data packet contains both the sender's address and the receiver's address.

The Internet Protocol ensures that the data packets all arrive at the intended address. As IP is a connectionless protocol, which means that there is no established connection between the communication end-points, packets can be sent via different routes and do not need to arrive at the destination in the correct order.

Once the data packets have arrived at the correct destination, another protocol - Transmission Control Protocol (TCP) - puts them in the right order. See also *TCP*.

IP Address - An IP address is simply an address on an IP network used by a computer/device connected to that network. IP addresses allow all the connected computers/devices to find each other and to pass data back and forth.

To avoid conflicts, each IP address on any given network must be unique. An IP address can be assigned as fixed, so that it does not change, or it can be assigned dynamically (and automatically) by DHCP.

An IP address consists of four groups (or quads) of decimal digits separated by periods, e.g. 130.5.5.25. Different parts of the address represent different things. Some part will represent the network number or address, and some other part will represent the local machine address.

See also *IP (Internet Protocol)*.

I-VOP - See *VOP*.

JPEG (Joint Photographic Experts Group) - Together with the GIF file format, JPEG is an image file type commonly used on the web. A JPEG image is a bitmap, and usually has the file suffix '.jpg' or '.jpeg.' When creating a JPEG image, it is possible to configure the level of compression to use. As the lowest compression (i.e. the highest quality) results in the largest file, there is a trade-off between image quality and file size.

kbit/s (kilobits per second) - A measure of the bit rate, i.e. the rate at which bits are passing a given point. See also *Bit rate*.

LAN (Local Area Network) - A LAN is a group of computers and associated devices that typically share common resources within a limited geographical area.

Linux - Linux is an open source operating system within the Unix family. Because of its robustness and availability, Linux has won popularity in the open source community and among commercial application developers.

MAC address (Media Access Control address) - A MAC address is a unique identifier associated with a piece of networking equipment, or more specifically, its interface with the network. For example, the network card in a computer has its own MAC address.

Manual iris - This is the opposite to an autoiris, i.e. the camera iris must be adjusted manually to regulate the amount of light allowed to reach the image sensor.

Mbit/s (Megabits per second) - A measure of the bit rate, i.e. the rate at which bits are passing a given point. Commonly used to give the "speed" of a network. A LAN might run at 10 or 100 Mbit/s. See also

Bit rate.

Monitor - A monitor is very similar to a standard television set, but lacks the electronics to pick up regular television signals.

Motion JPEG - Motion JPEG is a simple compression/decompression technique for networked video. Latency is low and image quality is guaranteed, regardless of movement or complexity of the image. Image quality is controlled by adjusting the compression level, which in turn provides control over the file size, and thereby the bit rate.

High-quality individual images from the Motion JPEG stream are easily extracted. See also JPEG.

Megapixel - See *Pixel*.

MPEG (Moving Picture Experts Group) - The Moving Picture Experts Group develops standards for digital video and audio compression. It operates under the auspices of the International Organization for Standardization (ISO). The MPEG standards are an evolving series, each designed for a different purpose.

MPEG-2 - MPEG-2 is the designation for a group of audio and video coding standards, and is typically used to encode audio and video for broadcast signals, including digital satellite and Cable TV. MPEG-2, with some modifications, is also the coding format used by standard commercial DVD movies.

MPEG-4 - MPEG-4 is a group of audio and video coding standards and related technology. The primary uses for the MPEG-4 standard are web (streaming media) and CD distribution, conversational (videophone), and broadcast television.

Most of the features included in MPEG-4 are left to individual developers to decide whether to implement them or not. This means that there are probably no complete implementations of the entire MPEG-4 set of standards. To deal with this, the standard includes the concept of "profiles" and "levels", allowing a specific set of capabilities to be defined in a manner appropriate for a subset of applications.

Multicast - Bandwidth-conserving technology that reduces bandwidth usage by simultaneously delivering a single stream of information to multiple network recipients.

Multiplexer - A multiplexer is a high-speed switch that provides full-screen images from up to 16 analog cameras. Multiplexers can playback everything that happened on any one camera with no interference from the other cameras on the system.

Network connectivity - The physical (wired or wireless) and logical (protocol) connection of a computer network or an individual device to a network, such as the Internet or a LAN.

NTSC (National Television System Committee) - NTSC is the television and video standard in the United States. NTSC delivers 525 lines at 60 half-frames/second.

OEM (Original Equipment Manufacturer) - This is a designation for companies that manufacture equipment which is then marketed and sold to other companies under their own names.

PAL (Phase Alternating Line) - PAL is the dominant television standard in Europe. PAL delivers 625 lines at 50 half-frames/second.

PEM (Privacy Enhanced Mail) - An early standard for securing electronic mail. The PEM-format is often used for representing an HTTPS certificate or certificate request.

Ping - Ping is a basic network program used diagnostically to check the status of a network host or device. Ping can be used to see if a particular network address (IP address or host name) is occupied or not, or if the host at that address is responding normally. Ping can be run from e.g. the Windows Command prompt or the command line in Unix.

Pixel - A pixel is one of the many tiny dots that make up a digital image. The colour and intensity of each pixel represents a tiny area of the complete image.

PoE (Power over Ethernet) - Power over Ethernet provides power to a network device via the same cable as used for the network connection. This is very useful for IP-Surveillance and remote monitoring applications in places where it may be too impractical or

expensive to power the device from a power outlet.

PPP (Point-to-Point Protocol) - A protocol that uses a serial interface for communication between two network devices. For example, a PC connected by a phone line to a server.

PPTP (Point-to-Point Tunnelling Protocol) - A protocol (set of communication rules) that allows corporations to extend their own corporate network through private "tunnels" over the public Internet. In this way a corporation can effectively use a WAN (Wide Area Network) as a large single LAN (Local Area Network). This kind of interconnection is known as a virtual private network (VPN).

Pre/post alarm images - The images from immediately before and after an alarm. These images are stored in a buffer for later retrieval.

Progressive scan - Progressive scan, as opposed to interlaced video, scans the entire picture, line by line every sixteenth of a second. In other words, captured images are not split into separate fields as in interlaced scanning.

Computer monitors do not need interlace to show the picture on the screen, but instead show them progressively, on one line at a time in perfect order, i.e. 1, 2, 3, 4, 5, 6, 7 etc., so there is virtually no "flickering" effect. In a surveillance application, this can be critical when viewing detail within a moving image, such as a person running. A high-quality monitor is required to get the best from progressive scan. See also *Interlacing*.

Protocol - A special set of rules governing how two entities will communicate. Protocols are found at many levels of communication, and there are hardware protocols and software protocols.

Proxy server - In an organisation that uses the Internet, a proxy server acts as an intermediary between a workstation user and the Internet. This provides security, administrative control, and a caching service. Any proxy server associated with a gateway server, or part of a gateway server, effectively separates the organisation's network from the outside network and the local firewall. It is the firewall server that protects the network against outside intrusion.

A proxy server receives requests for Internet services (such as web page requests) from many users. If the proxy server is also a cache server, it looks in its local cache of previously downloaded web pages. If it finds the page, it is returned to the user without forwarding the request to the Internet. If the page is not in the cache, the proxy server, acting as a client on behalf of the user, uses one of its own IP addresses to request the page from another server over the Internet. When the requested page is returned, the proxy server forwards it to the user that originally requested it.

P-VOP - See *VOP*.

Resolution - Image resolution is a measure of how much detail a digital image can hold: the greater the resolution, the greater the level of detail. Resolution can be specified as the number of pixel-columns (width) by the number of pixel-rows (height), e.g. 320x240.

Alternatively, the total number of pixels (usually in megapixels) in the image can be used. In analog systems it is also common to use other format designations, such as CIF, QCIF, 4CIF, etc.

RTCP (Real-Time Control Protocol) - RTCP provides support for real-time conferencing of groups of any size within an intranet. This support includes source identification and support for gateways like audio and video bridges as well as multicast-to-unicast translators.

RTCP offers quality-of-service feedback from receivers to the multicast group as well as support for the synchronization of different media streams.

RTP (Real-Time Transport Protocol) - RTP is an Internet protocol for the transport of real-time data, e.g. audio and video. It can be used for media-on-demand as well as interactive services such as Internet telephony.

RTSP (Real Time Streaming Protocol) - RTSP is a control protocol, and a starting point for negotiating transports such as RTP, multicast and Unicast, and for negotiating codecs.

RTSP can be considered a "remote control" for controlling the media stream delivered by a media server. RTSP servers typically use RTP as the protocol for the actual transport of audio/video data.

Router - A device that determines the next network point to which a packet should be forwarded on its way to its final destination. A router creates and/or maintains a special routing table that stores information on how best to reach certain destinations. A router is sometimes included as part of a network switch. See also *switch*.

Server - In general, a server is a computer program that provides services to other computer programs in the same or other computers. A computer running a server program is also frequently referred to as a server. In practice, the server may contain any number of server and client programs. A web server is the computer program that supplies the requested HTML pages or files to the client (browser).

Sharpness - This is the control of fine detail within a picture. This feature was originally introduced into color TV sets that used notch filter decoders. This filter took away all high frequency detail in the black and white region of the picture. The sharpness control attempted to put some of that detail back in the picture. Sharpness controls are mostly superfluous in today's high-end TVs. The only logical requirement for it nowadays is on a VHS machine.

Simplex - In simplex operation, a network cable or communications channel can only send information in one direction.

SMTP (Simple Mail Transfer Protocol) - SMTP is used for sending and receiving e-mail. However, as it is "simple," it is limited in its ability to queue messages at the receiving end, and is usually used with one of two other protocols, POP3 or IMAP. These other protocols allow the user to save messages in a server mailbox and download them periodically from the server.

SMTP authentication is an extension of SMTP, whereby the client is required to log into the mail server before or during the sending of email. It can be used to allow legitimate users to send email while denying the service to unauthorized users, such as spammers.

SNMP (Simple Network Management Protocol) - SNMP forms part of the Internet Protocol suite, as defined by the Internet Engineering Task Force. The protocol can support monitoring of network-attached devices for any conditions that warrant administrative attention.

Sockets - Sockets are a method for communication between a client program and a server program over a network. A socket is defined as "the endpoint in a connection." Sockets are created and used with a set of programming requests or "function calls" sometimes called the sockets application programming interface (API).

SSL/TSL (Secure Socket Layer/Transport Layer Security)

These two protocols (SSL is succeeded by TSL) are cryptographic protocols that provide secure communication on a network. SSL is commonly used over HTTP to form HTTPS, as used e.g. on the Internet for electronic financial transactions. SSL uses public key certificates to verify the identity of the server.

Subnet/subnet mask - A subnet is an identifiably separate part of an organization's network. Typically, a subnet may represent all the machines at one geographic location, in one building, or on the same local area network (LAN). Having an organization's network divided into subnets allows it to be connected to the Internet with a single shared network address.

The subnet mask is the part of the IP address that tells a network router how to find the subnet that the data packet should be delivered to. Using a subnet mask saves the router having to handle the entire 32-bit IP address; it simply looks at the bits selected by the mask.

Switch - A switch is a network device that connects network segments together, and which selects a path for sending a unit of data to its next destination. In general, a switch is a simpler and faster mechanism than a router, which requires knowledge about the network and how to determine the route. Some switches include the router function. See also *Router*.

TCP (Transmission Control Protocol) - TCP is used along with the Internet Protocol (IP) to transmit data as packets between computers over the network. While IP takes care of the actual packet delivery, TCP keeps track of the individual packets that the communication (e.g. requested a web page file) is divided into, and, when all packets have arrived at their destination, it reassembles them to re-form the complete file.

TCP is a connection-oriented protocol, which means that a connection is established between the two end-points and is maintained until the data has been successfully exchanged between the communicating applications.

Telnet - Telnet is a simple method with which to access another network device, e.g. a computer. The HTTP protocol and the FTP protocols allow you to request specific files from remote computers, but do not allow you logon as a user of that computer. With Telnet, you log on as a regular user with whatever privileges you may have been granted for specific applications and data residing on that computer.

TVL (TV Lines) - A method of defining resolutions in analog video.

UDP (User Datagram Protocol) - UDP is a communications protocol that offers limited service for exchanging data in a network that uses the Internet Protocol (IP). UDP is an alternative to the Transmission Control Protocol (TCP). The advantage of UDP is that it is not required to deliver all data and may drop network packets when there is e.g. network congestion. This is suitable for live video, as there is no point in re-transmitting old information that will not be displayed anyway.

Unicast - Communication between a single sender and a single receiver over a network. A new connection is established for each new user.

URL (Uniform Resource Locator) - An "address" on the network.

USB - (Universal Serial Bus) A plug-and-play interface between a computer and peripheral devices, e.g. scanners, printers, etc.

Varifocal lens - A varifocal lens provides a wide range of focal lengths, as opposed to a lens with a fixed focal length, which only provides one.

VPN (Virtual Private Network) - This creates a secure "tunnel" between the points within the VPN. Only devices with the correct "key" will be able to work within the VPN. The VPN network can be within a company LAN (Local Area Network), but different sites can also be connected over the Internet in a secure way. One common use for VPN is for connecting a remote computer to the corporate network, via e.g. a direct phone line or via the Internet.

VOP (Video Object Plane) - A VOP is an image frame in an MPEG-4 video stream. There are several types of VOP:

- An I-VOP is complete image frame.

- A P-VOP codes the differences between images, as long as it is more efficient to do so. Otherwise it codes the whole image, which may also be a completely new image.

WAN (Wide-Area-Network) - Similar to a LAN, but on a larger geographical scale.

W-LAN (Wireless LAN) - A wireless LAN is a wireless local area network that uses radio waves as its carrier: where the network connections for end-users are wireless. The main network structure usually uses cables.

Web server - A Web server is a program, which allows Web browsers to retrieve files from computers connected to the Internet. The Web server listens for requests from Web browsers and upon receiving a request for a file sends it back to the browser.

The primary function of a Web server is to serve pages to other remote computers; consequently, it needs to be installed on a computer that is permanently connected to the Internet. It also controls access to the server whilst monitoring and logging server access statistics.

WEP (Wireless Equivalent Privacy) - A wireless security protocol, specified in the IEEE 802.11 standard, which is designed to provide a wireless local area network (WLAN) with a level of security and privacy comparable to that usually expected of a wired LAN. Security is at two different levels; 40-bit and 128-bit encryption. The higher the bit number, the more secure the encryption.

WINS (Windows Internet Naming Service) - Part of the Microsoft Windows NT Server, WINS manages the association of workstation names and locations with IP addresses, without the user or administrator having to be involved in each configuration change.

WPA-PSK (Wi-Fi Protected Access - Pre-Shared Key) - This wireless encryption method uses a pre-shared key (PSK) for key management. Keys can usually be entered as manual hex values, as hexadecimal characters, or as a Passphrase. WPA-PSK provides a greater degree of security than WEP.

Zoom lens - A zoom lens can be moved (zoomed) to enlarge the view of an object to show more detail.

Index

A

- Action 16
- Action Buttons 14
- Administrator 11
- Alarm 19
- AMC 7
- AMC Viewer Toolbar 8
- ARP/Ping 21
- Audio 14

B

- Backup 25
- Bit Rate 13
- Bonjour 7
- Buffer Size 17
- Buffers 17

C

- Configuration 11
- Control Button 6, 26

D

- Date & Time 21
- Default Viewer 15
- DNS Configuration 22
- DNS Server 22
- Domain Name 22

E

- Emergency Recovery 27
- Enable ARP/Ping 21
- Event Servers 16
- Events 16

F

- Factory Default Settings 26
- Frame Rate 12
- FTP Server 16

G

- GOV Settings 13

H

- Host Name 22
- HTTP Server 16
- HTTPS 20

I

- Include Windows 19
- IP Address Filtering 20

L

- Live View 8, 11
- Live View Config 14
- Logs & Reports 26

M

- Motion Detection 19
- MPEG-4 Settings 13

N

- NAT traversal 8, 22, 23
- Network Settings 21
- Notification of IP address change 21
- NTP Server 21

P

- Post-trigger Buffer 17
- Pre-trigger Buffer 17

Q

- QoS 24
- QuickTime 7, 10, 15

R

- Real Player 7, 10
- Recovery 27
- Referrals 20
- Restore 25

S

- Scheduled Event 16, 18
- Security 20
- Server Time 21
- Services 21
- Snapshot button 8
- SNMP 24
- Support 25
- System Options 20

T

- TCP Server 16
- TCP/IP Settings 21
- Time Mode 21
- Triggered Event 16
- Troubleshooting 27

U

- Upgrade Server 25
- Uploading web files 14
- UPnP 22, 25
- Users 20

V

- Video Stream 12