

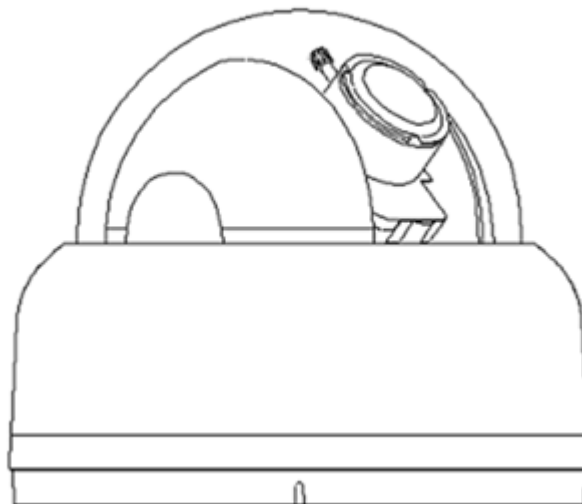

American Dynamics

From Tyco Security Products

Illustra Flex Series 1MP & 3MP Indoor Dome User Guide



Notice

Please read this manual thoroughly and save it for future use before attempting to connect or operate this unit.

The information in this manual was current when published. The manufacturer reserves the right to revise and improve its products. All specifications are therefore subject to change without notice.

Copyright

Under copyright laws, the contents of this manual may not be copied, photocopied, reproduced, translated or reduced to any electronic medium or machine-readable form, in whole or in part, without prior written consent of Tyco Security Products. © 2013 Tyco Security Products. All rights reserved.

American Dynamics
6600 Congress Avenue
Boca Raton, FL 33487 U.S.A.

Customer Service

Thank you for using American Dynamics products. We support our products through an extensive worldwide network of dealers. The dealer through whom you originally purchased this product is your point of contact if you need service or support. Our dealers are empowered to provide the very best in customer service and support. Dealers should contact American Dynamics at (800) 507-6268 or (561) 912-6259 or on the Web at www.americandynamics.net.

Trademarks

The trademarks, logos, and service marks displayed on this document are registered in the United States [or other countries]. Any misuse of the trademarks is strictly prohibited and Tyco Security Products. will aggressively enforce its intellectual property rights to the fullest extent of the law, including pursuit of criminal prosecution wherever necessary. All trademarks not owned by Tyco Security Products. are the property of their respective owners, and are used with permission or allowed under applicable laws.

Product offerings and specifications are subject to change without notice. Actual products may vary from photos. Not all products include all features. Availability varies by region; contact your sales representative.

Table of Contents

WARNING	4
Preface.....	5
1. Product Overview.....	6
1.1 Physical Characteristics.....	6
2. Installation and Connection	10
2.1 Unpack Everything.....	10
2.2 Installation	10
2.2.1 Checking Appearance	10
2.2.2 Disassembling the Camera	11
2.2.3 Connecting the wires.....	11
2.2.4 Mounting the camera.....	12
2.2.5 Adjusting the Position.....	14
2.2.6 Adjusting Zoom and Focus.....	15
2.2.7 Locking the camera	15
2.2.8 Network Topology.....	15
2.2.9 System Requirements.....	16
2.3 Connection	17
2.3.1 Default IP address.....	17
2.3.2 Connecting from a computer & Viewing Preparation	17
2.4 Using the illustra Connect Tool to Manage Cameras.....	20
3. Administration and Configuration.....	21
3.1 Live View.....	21
3.2 Configuration.....	22
3.2.1 Image Parameters.....	22
3.2.2 Network Settings	36
3.2.3 System Settings	40
3.2.4 Event Settings	45
3.2.5 Record Settings.....	47
Appendix: Specification of Illustra Flex Indoor Dome	51

WARNING

- This unit operates at DC 12V/ AC 24V/ PoE.
- Installation and service should be performed only by qualified and experienced technicians and comply with all local codes and rules to maintain your warranty.
- To reduce the risk of fire or electric shock, do not expose the product to rain or moisture.
- Wipe the camera with a dry soft cloth. For tough stains, slightly apply with diluted neutral detergent and wipe with a dry soft cloth.
- Do not apply benzene or thinner to the camera, which may cause the surface of the unit to be melted or lens to be fogged.
- Avoid aligning the lens to very bright objects (example, light fixtures) for long periods of time.
- Avoid operating or storing the unit in the following locations:
 - ✓ Extremely humid, dusty, or hot/cold environments (recommended operating temperature: -10°C to +40°C)
 - ✓ Close to sources of powerful radio or TV transmitters
 - ✓ Close to fluorescent lamps or objects with reflections
 - ✓ Under unstable or flickering light sources

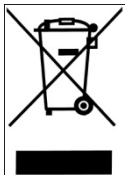
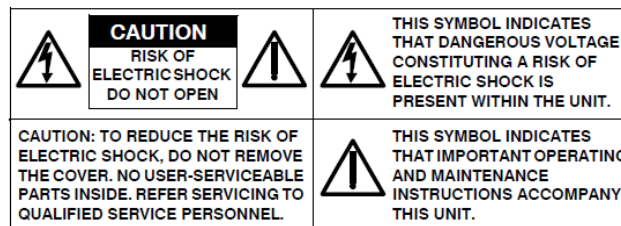

WEEE (Waste Electrical and Electronic Equipment). Correct disposal of this product (applicable in the European Union and other European countries with separate collection systems). This product should be disposed of, at the end of its useful life, as per applicable local laws, regulations, and procedures.

Preface

This user manual is designed as a reference for the installation and manipulations of the unit including the camera's features, functions, and detailed explanation of the menu tree. The reader is supposed to be able to get following information in the manual.

Product Overview: the main functions and system requirements of the unit.

Installation and Connection: instructions on unit installation and wire connections.

Administration and Configuration: the main menu navigation and controls explanations.

1. Product Overview

1.1 Physical Characteristics

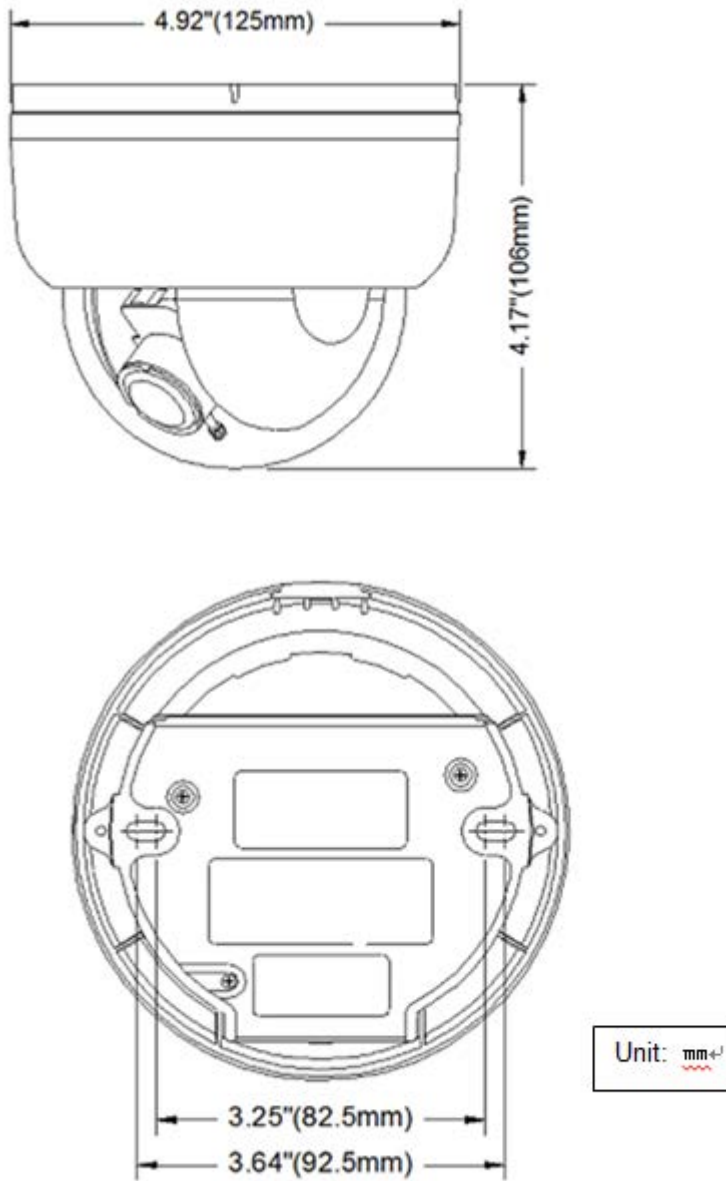

FIGURE 1-1: PHYSICAL DIMENSION

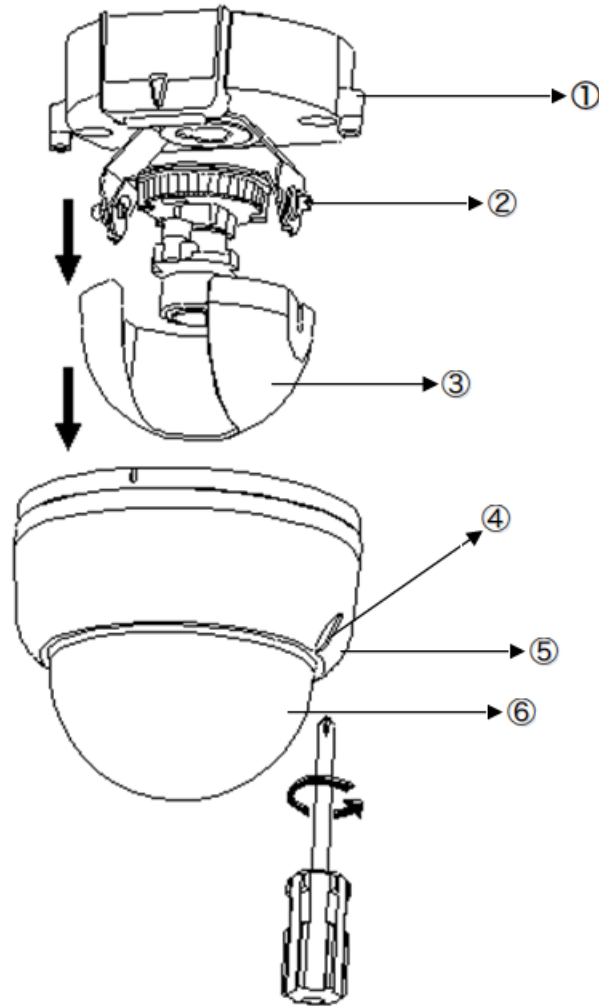

FIGURE 1-2: PICTORIAL INDEX

TABLE 1-1: PICTORIAL INDEX DEFINITION

Index #	Description
1	Camera bottom case
2	Tilt adjustment bracket and thumbnuts, notches(X2) Notches (x2)
3	Inner liner
4	Loosen the screw to take off camera housing
5	Camera housing
6	Dome cover

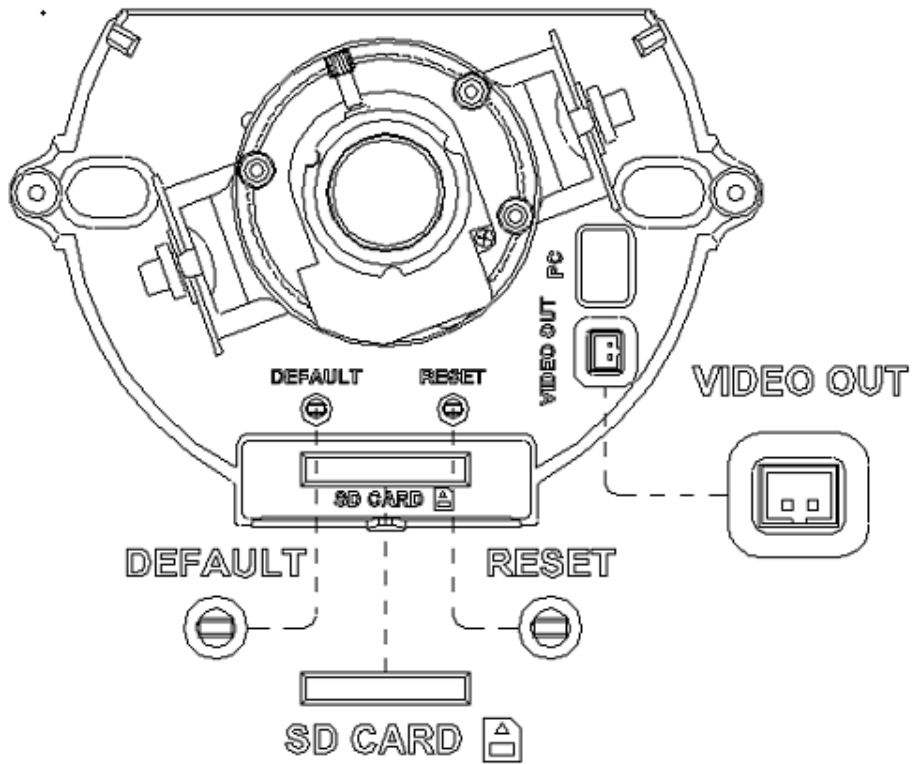



FIGURE 1-3: INTERIOR BUTTONS & INLETS 1/2

TABLE 1-2: INTERIOR BUTTONS DEFINITIONS 1/3

DEFAULT 	RESET 	DEFAULT	To reset to factory default by pressing and holding the button for 5 seconds
		RESET	To reboot the unit

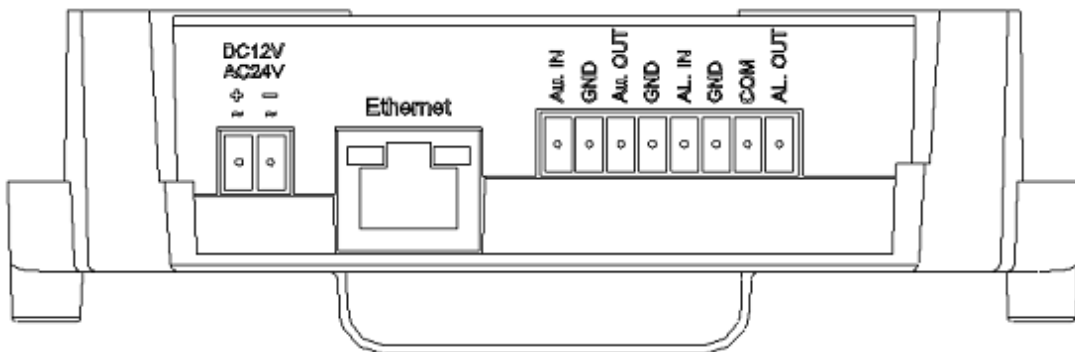

FIGURE 1-4: EXTERIOR INLETS 2/2

Note Connectors and field wiring terminals for external Class 2 circuits provided with marking indicating minimum Class of wiring to be used. Class 2 shall be marked adjacent to the field wiring terminals.

TABLE 1-3: EXTERIOR DEFINITION 2/3

	Au/I	Audio in
	GND	
	Au/O	Audio out
	GND	
	AI	Alarm in
	GND	
	AO	Alarm out
	GND	

TABLE 1-4: EXTERIOR DEFINITION 3/3

DC12V AC24V 	DC 12V	Network indoor dome camera can operate on DC 12V / AC 24V
	AC 24V	

2. Installation and Connection

2.1 Unpack Everything

Check everything in the packing box matches to the order form and the packing slip. In addition to this manual, items below are included in the packing box.

- One Network Indoor Dome Camera
- One 2-pin camera block for power input, and one 8-pin terminal block for alarm input/output
- One CD containing Illustra Connect, user manual and quick installation guide
- One printed quick installation guide
- One monitor out cable
- One mounting template
- Two screw anchors
- Two screws

Please contact your dealer if any item missing.

2.2 Installation

Following tools might help you complete the installation:

- a drill
- screwdrivers
- wire cutters

2.2.1 Checking Appearance

When first unboxing, please check whether if there is any visible damage to appearance of the unit and its accessories. The protective materials used for the packaging should be able to protect the unit from most of accidents during transportation.

Please remove the protective film of the unit when every item is checked in accordance with the list in [2.1 Unpacking Everything](#).

2.2.2 Disassembling the Camera

Please refer to the figure 2-1 for pictorial index. Gently press the button to take off camera off camera housing (4). Remove the inner liner (3) by gently pulling it free of the two notches (2) in the housing. Set the camera a housing (5) and inner liner (3) aside.

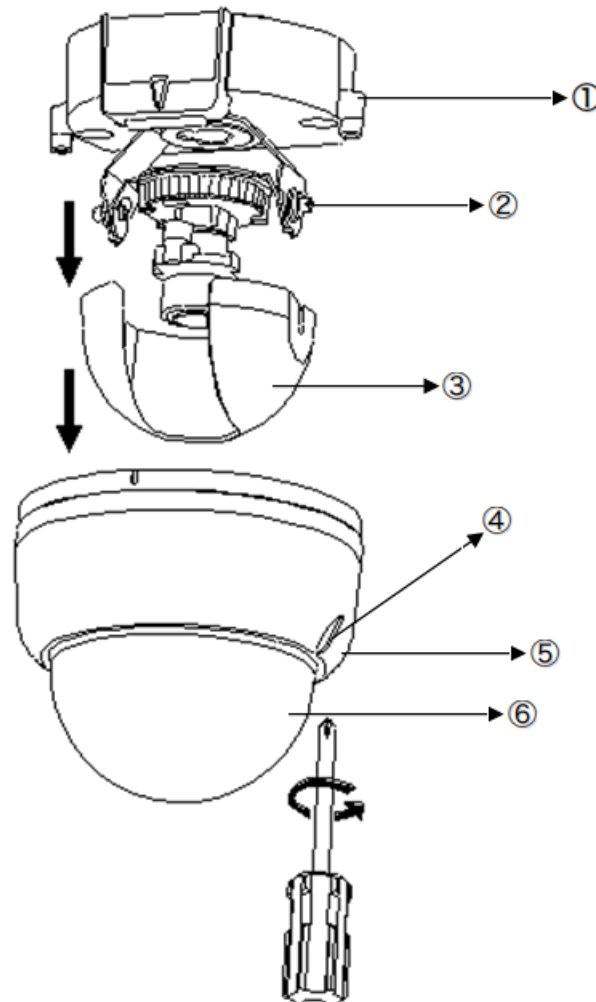

FIGURE 2-1: DISASSEMBLING THE CAMERA

2.2.3 Connecting the wires

This unit supports one of the following options as power supply.

- **DC 12V:** Connect 12V (–) to terminal =DC 12V–, and Connect 12V (+) to terminal =DC 12V+
- **AC 24V:** Connect 24V (~) cables to terminals ~AC 24V
- **PoE:** Connect the RJ-45 jack to a PoE compatible network device that supplied power through the Ethernet cable

Insert Audio cable and alarm cable to the unit, and connect the network cable to the RJ-45 terminal of a switch.

Caution If using DC supply, make sure the polarity is correct. Incorrect connection may cause malfunction and/or damage to the unit.

2.2.4 Mounting the camera

Please place the mounting template as supplied on the mounting surface and mark the holes. Drill two holes, and then insert the screw anchors into the holes. Next, take off the camera housing. Connect the Safety Wire (fall prevention wire, not supplied) with one end to the ceiling and the other to the safety-cord screw of the unit.

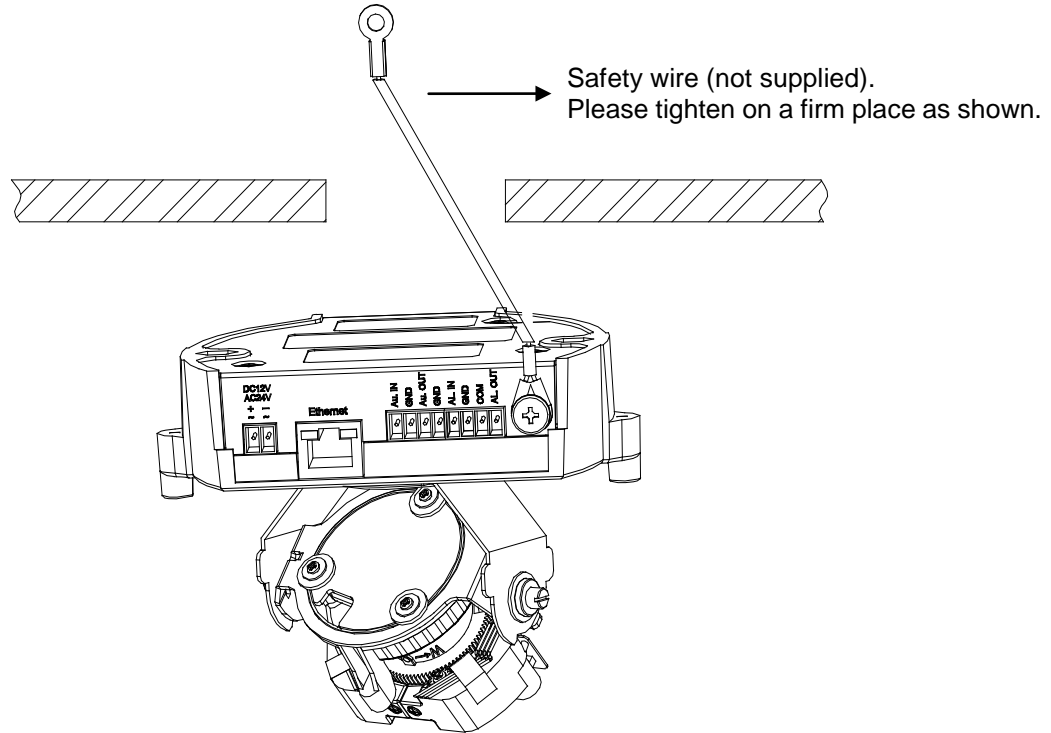

FIGURE 2-2: MOUNTING THE CAMERA 1/2

Refer to figure 2-3. Secure the camera bottom case to the wall/ceiling with the TP4×15 mm tapping screws as supplied, and then insert the power cable, network cable and audio cable. Adjust the viewing angel (zoom, focus, and Horizontal Rotation) as described in [2.2.5 Adjusting the Position](#).

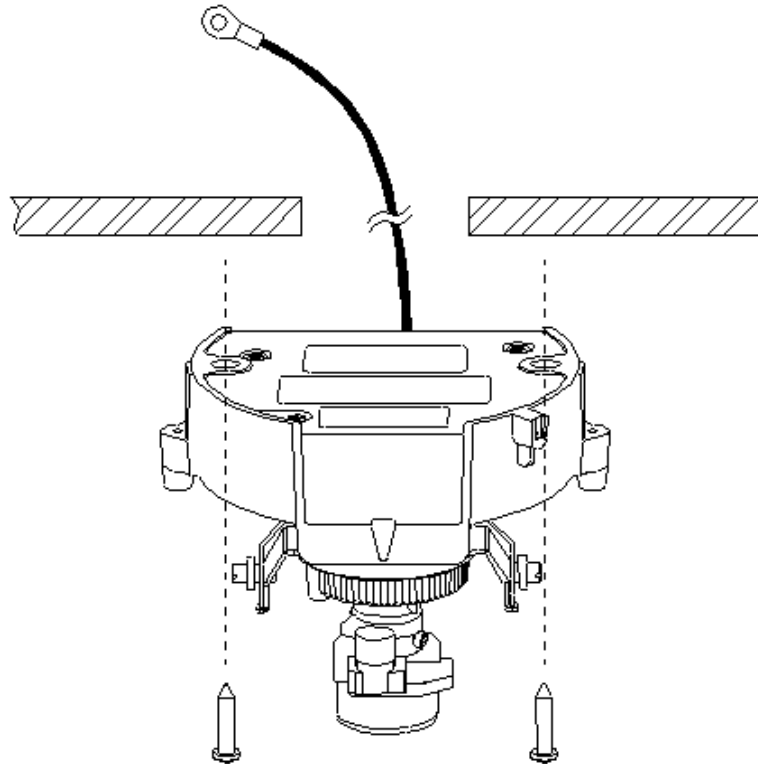

FIGURE 2-3: MOUNTING THE CAMERA 2/2

Warning Depending on the material of your mounting surface, you may require different screws and anchors than those as supplied. To prevent the unit from falling off, ensure that it is secured to a firm place (ceiling slab or channel) with a safety wire (not supplied) strong enough to sustain the total weight of the unit. (Pay also attention to the finishing at the end of the wire.) Never turn the lens more than 360°, which should disconnect or break internal cables.

Caution Safety wire must be connected with one end to the ceiling and the other to the safety-cord screw of the unit.

2.2.5 Adjusting the Position

The unit has three axes for positioning. While monitoring, adjust the position as below.

- **Pan Adjustment (A):** For Wall Mount and Tilted Ceilings Rotate the lens base (maximum 350°) until you are satisfied with the field of view.
- **Horizontal Rotation (B):** Rotate 3D assembly in the base. Do not turn assembly more than 350° as this assembly may cause the internal cables to twist and disconnect or break.
- **Tilt Adjustment (C):** After loosening the thumbnuts, position the camera as desired, then finger-tighten the thumbnuts to set the position.

Caution	Limitation for three axes position:
	• Pan range: $\pm 175^\circ$
	• Tilt range: $15^\circ \sim 90^\circ$
	• Rotate range: Manual Lens $\pm 180^\circ$ / Motorize Lens $\pm 175^\circ$

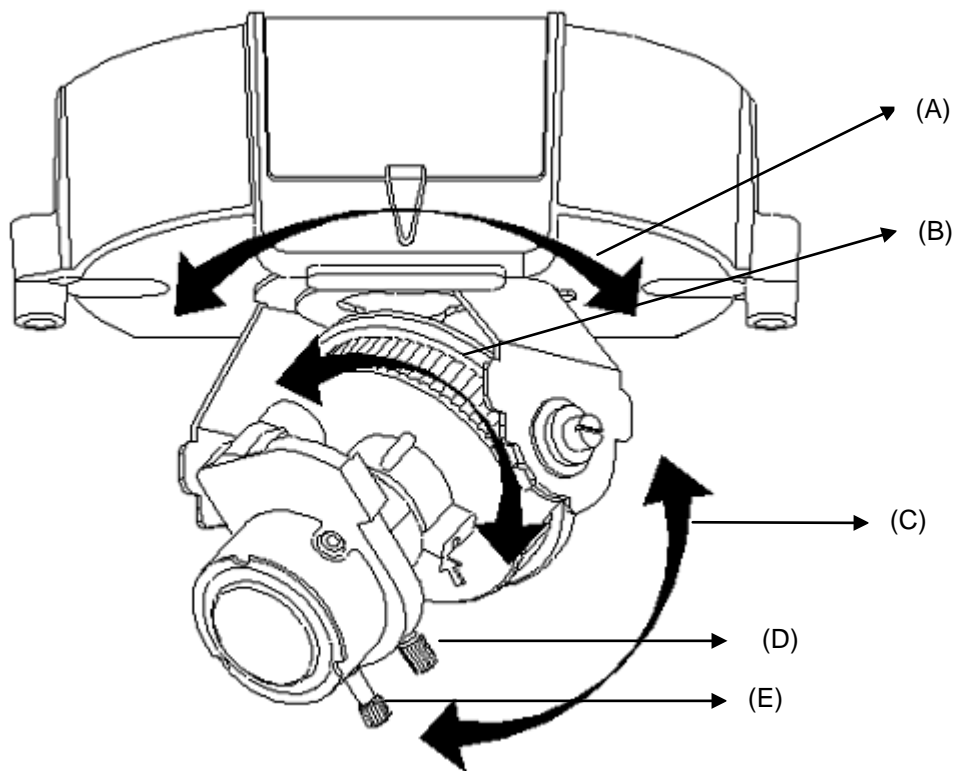

FIGURE 2-4: ADJUSTING THE POSITION

2.2.6 Adjusting Zoom and Focus

Loosen the zoom lever (D) / locking screw by turning it counter-clockwise. Rotate the zoom ring to achieve the desired picture. Loosen the focus lever (E) / locking screw by turning it counter-clockwise. Rotate the focus ring to adjust the focus. Repeat as required if further adjustments. When finished, retighten the zoom lever (D) / locking screw and the focus lever (E) / locking screw.

Caution Retighten the locking screws to prevent readjustments.

2.2.7 Locking the camera

Use soft, lint-free cloth to wipe the dome cover and remove fingerprints. Attach the inner liner and camera housing. Turn the power on after you have installed the unit.

2.2.8 Network Topology

The camera can deliver video images and audio in real time using the Internet and Intranet. It's equipped with Ethernet RJ-45 network interface.



FIGURE 2-5: NETWORK TOPOLOGY TYPE I

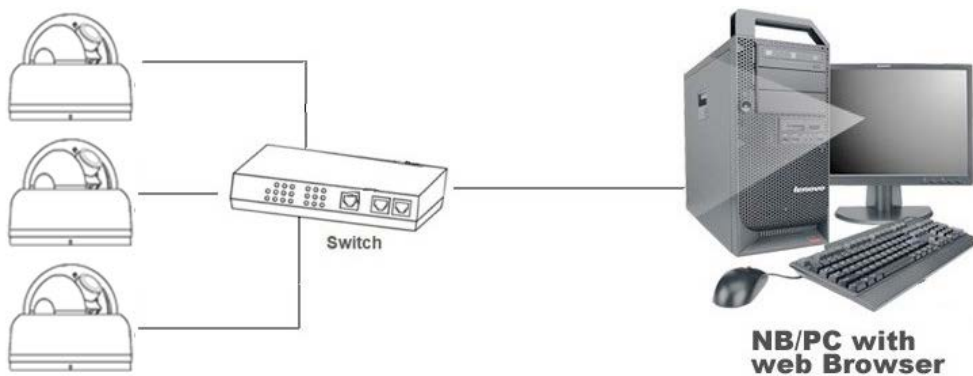

FIGURE 2-6: NETWORK TOPOLOGY TYPE II

2.2.9 System Requirements

Below table lists the minimum requirement to implement and operate a unit. No hardware/software component underestimated is recommended.

TABLE 2-1: SYSTEM REQUIREMENTS

System Hardware	
CPU	Intel Pentium 4 2.4GHz or equivalent
RAM	1 GB or above
Display	NVIDIA GeForce 6 Series or ATI Mobility Radeon 9500
System Software	
Operating System	Microsoft Windows XP, Windows Vista, or Windows 7
Browser	Microsoft Internet Explorer 8 or above
Unit	
Power Supply	DC 12V / AC 24V / PoE
Networking	
Wired*	10/100BASE-T Ethernet (RJ-45 connector)

**a switch is required for surveillance on multiple units.*

Note All the installation and operations should comply with your local electricity safety rules.

Caution To avoid damage to the unit, never connect more than one type of power supply (PoE IEEE802.3 Ethernet Class 0 or DC 12V / AC 24V power plug) at the same time. If using PoE, this unit must be connecting only to PoE networks without routing to heterogeneous devices.

2.3 Connection

2.3.1 Default IP address

Since this is a network-based unit, an IP address must be assigned at the very first. The unit's default IP address is **192.168.1.168** and sub mask is **255.255.255.0**. However, if you have a DHCP server in your network, the unit would obtain an IP address automatically from the DHCP server so that you don't need to change the camera's IP address. But be sure to enable DHCP in "Network/Basic settings".

2.3.2 Connecting from a computer & Viewing Preparation

2.3.2.1 Connecting from a computer

1. Make sure the unit and your computer are in the same subnet.
2. Check whether if the networking available between the unit and the computer by executing ping the default IP address. To do this, simply start a command prompt (Windows: from the Start Menu, select Program. Then select Accessories and choose Command Prompt.), and type "Ping 192.168.1.168". If the message "Reply from..." appears, it means the connection is available.
3. Start Internet Explorer and enter IP address: **192.168.1.168**. A login window should pop up. In the window, enter the default user name: **admin** and password: **admin** to log in.

Further information on administration of the unit can be found in "[3. Administration and Configuration](#)".

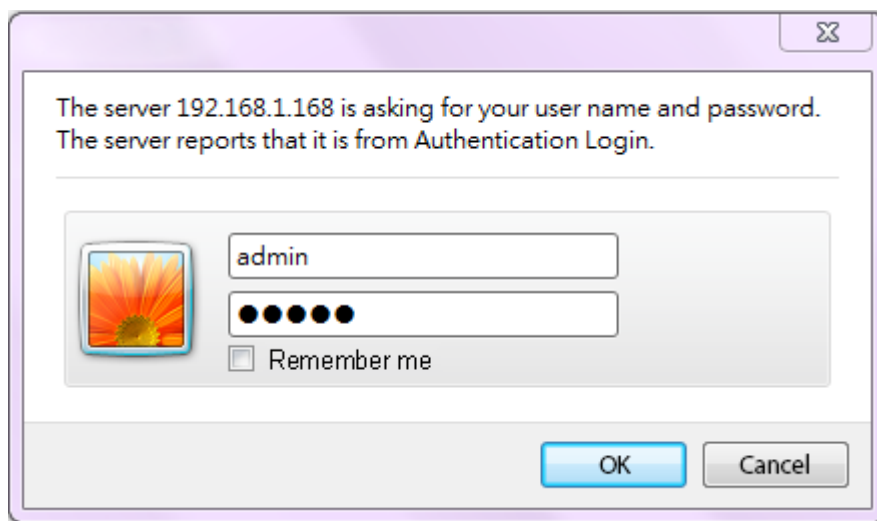

FIGURE 2-7: LOGIN WINDOW

2.3.2.2 Viewing Preparation

Images of the unit can be viewed through Microsoft Internet Explorer 8 or above. Before viewing, follow these steps to enable the display.

1. Enable Cookies as instructions below
 - In Internet Explorer, click **Internet Options** on the **Tools** menu.
 - On the **Privacy** tab, move the settings slider to **Low** or **Accept All Cookies**.
 - Click **OK**.
2. When a proxy server is used, click Internet Options on the Tools menus of Internet Explorer, select Connect tab, click LAN button, and set proxy server.
3. Change Security in Internet options as instructions below
 - On **Tools** menu, click **Internet Options**.
 - Press the **Security** tab.
 - If the camera operates inside of the intranet, click the **Intranet** icon.
 - If the camera operates outside of the intranet, click the **Internet** icon.
 - Click **Custom Level**. This will open the **Security Settings – Internet Zone** screen.

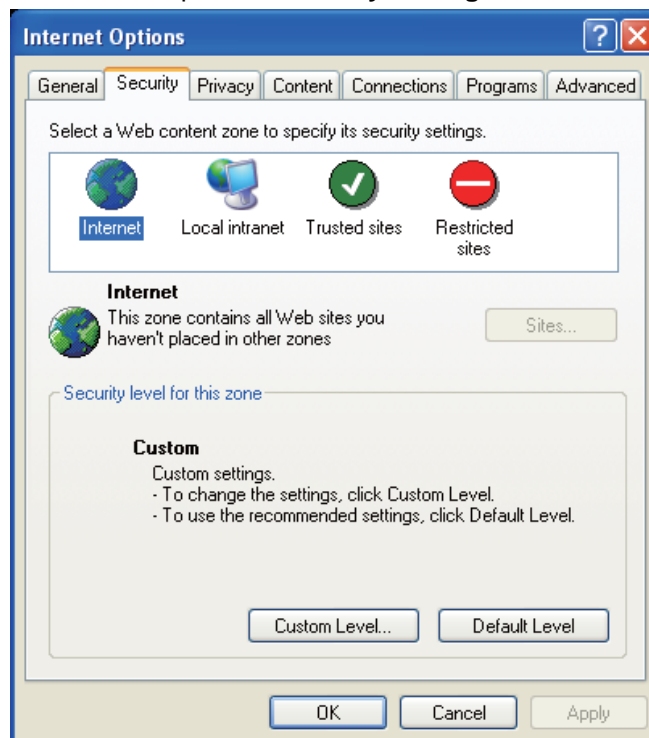

FIGURE 2-8: SECURITY SETTINGS 1/4

- Scroll down to the ActiveX controls and plug-ins radio buttons and set as follows:
 - 【Download signed ActiveX controls】 → Prompt (recommended)
 - 【Download unsigned ActiveX controls】 → Prompt
 - 【Initialize and script ActiveX not marked as safe for scripting】 → Prompt

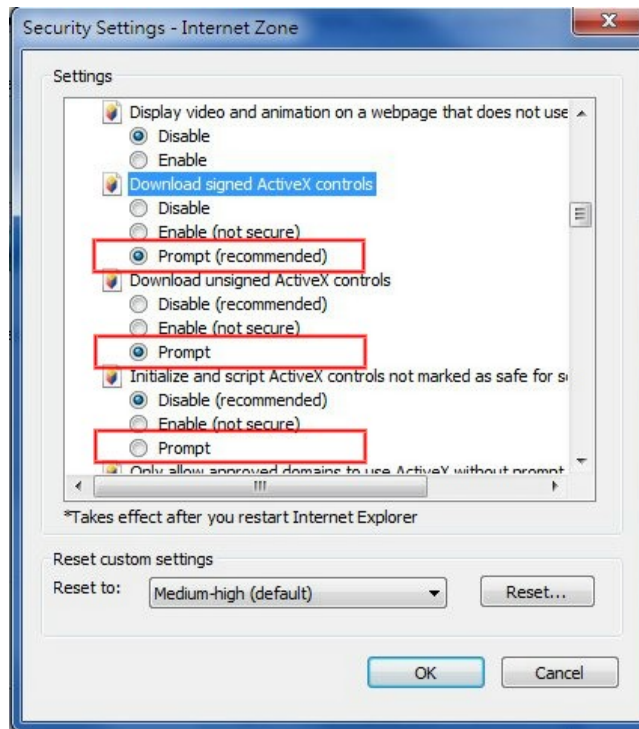

FIGURE 2-9: SECURITY SETTINGS 2/4

- 【Automatic prompting for ActiveX controls】 → Enable

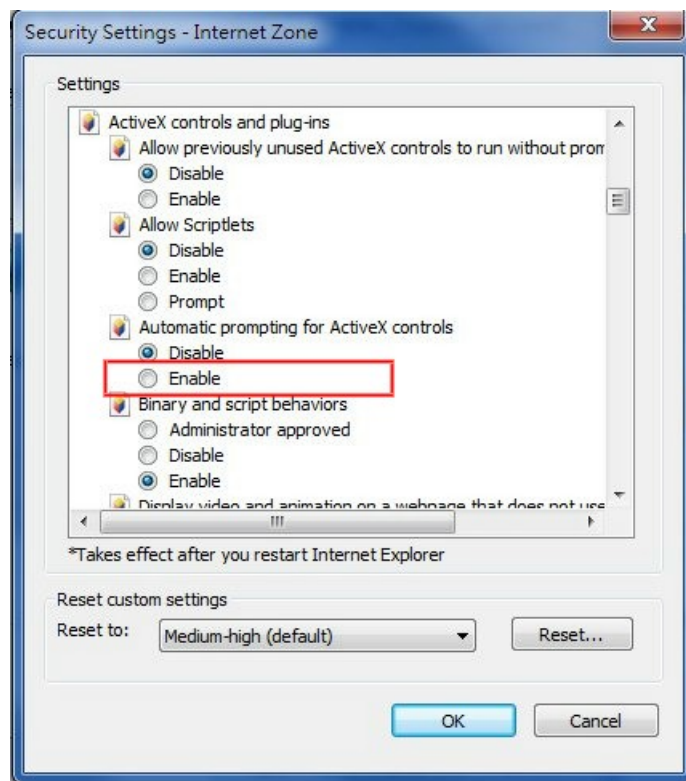

FIGURE 2-10: SECURITY SETTINGS 3/4

【Run ActiveX controls and plug-ins】 → Enable

【Script ActiveX controls marked safe for scripting*】 → Enable

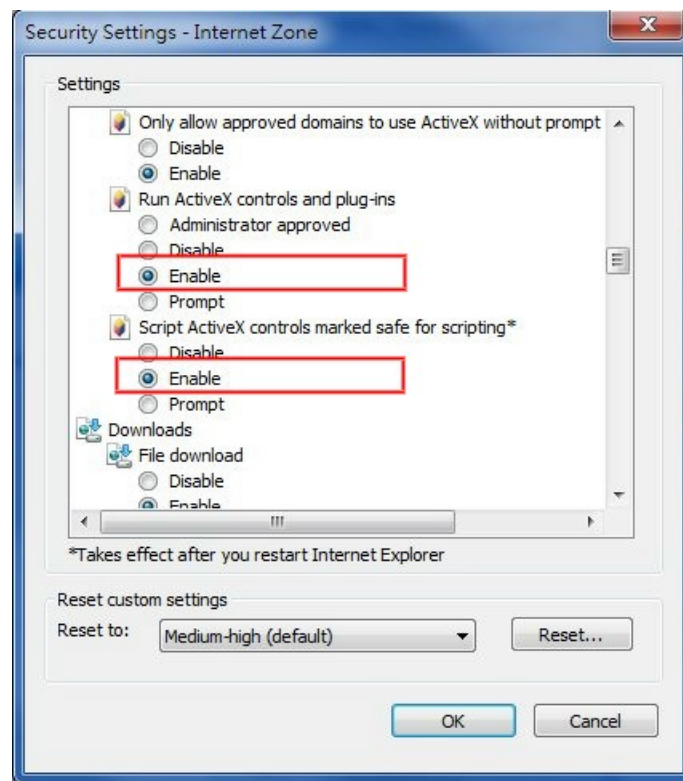

FIGURE 2-11: SECURITY SETTINGS 4/4

- Press OK to save the settings.
- Close all Microsoft Internet Explorer Windows and restart a new window. This will allow the new settings taking effect.
- Type your setting IP address into the browser.
- Then you should be able to see the camera image screen.

2.4 Using the illustra Connect Tool to Manage Cameras

In addition to using the IE browser to access your camera, you can alternatively use the provided tool, illustra Connect.

illustra Connect is a management tool designed to manage your network cameras on the LAN. It can:

- help you find multiple network cameras
- set the IP addresses
- show connection status
- manage firmware upgrades

For further information on Illustra Connect, refer to the Illustra Connect User Guide, located on the CD supplied.

3. Administration and Configuration



3.1 Live View

Simply click on **Live View** on the top left side of the browser window while accessing the IP address of the unit, and a live video is displayed directly in the browser window. When clicked on **Configuration**, a window will be pop out for configuring “Image Parameters”, “Network Settings”, “System Settings”, “Event Settings”, and “Record Settings”. Please refer to [3.2 Configuration](#) for more information. The current logged in identity shows next right. If clicked on **Logout**, this window of administration and configuration will be closed.

Followings are explanations to the tabs on the left of the window.

- Stream 1/Stream 2/Stream 3: The unit offers a concurrent triple* streams for optimized quality and bandwidth. Click start or stop to play or stop the video.
- Snapshot: Take a picture from live view.

Followings are explanations to the icons on the stream status bar

- : This icon indicates a motion event detected. When turned on and triggered, the little man keeps running. Please refer to [3.2.4 Event Settings](#) for more information.
- : This icon indicates an alarm event detected. When turned on and triggered, it begins to turn in red. Please refer to [3.2.4 Event Settings](#) for more information.

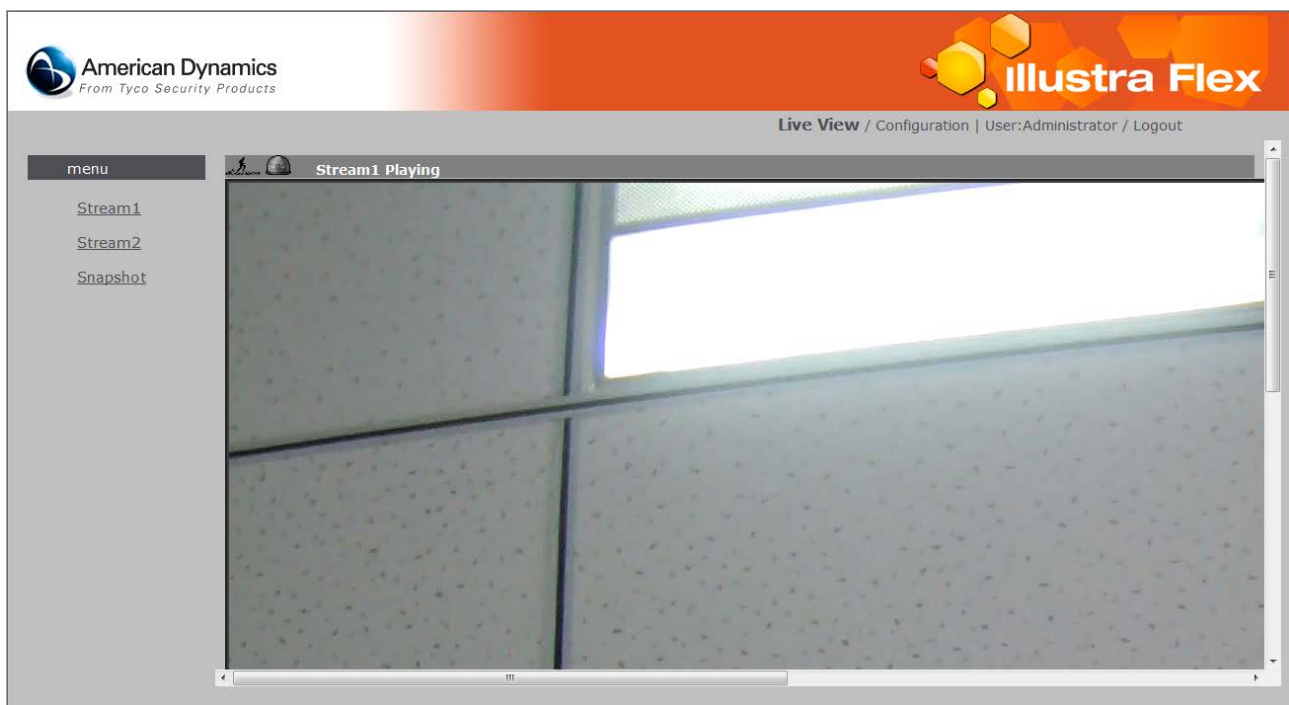

FIGURE 3-1: LIVE VIEW

* When the resolution is set to 2048x1536 or 2304x1296, only one single streaming is available.

3.2 Configuration

When clicked on **Configuration**, a window will be pop out for configuring “Image Parameters”, “Network Settings”, “System Settings”, “Event Settings”, and “Record Settings”.

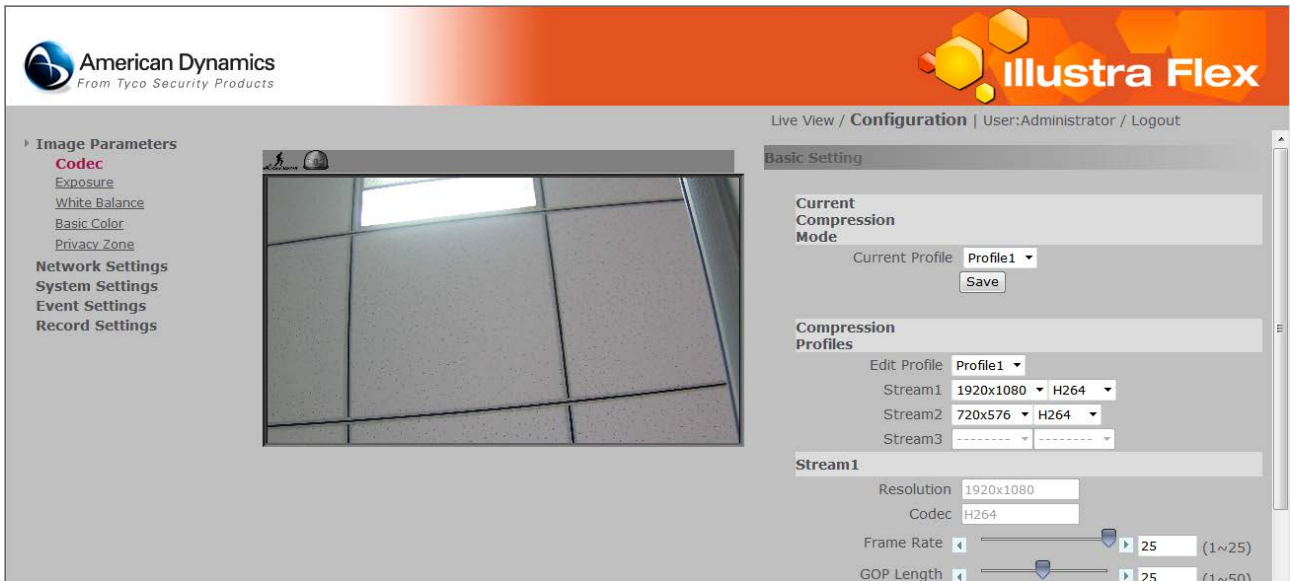

FIGURE 3-2: CONFIGURATION

3.2.1 Image Parameters



FIGURE 3-3: IMAGE PARAMETER

3.2.1.1 Codec

Basic Setting

Current Compression Mode

Current Profile: Profile1

Compression Profiles

Edit Profile: Profile1

Stream1: 1280x720 H264

Stream2: 1280x720 H264

Stream3: 800x600 H264

Stream1

Resolution: 1280x720

Codec: H264

Frame Rate: 25 (1~25)

GOP Length: 25 (1~50)

Rate Control: CBR

CBR BitRate: 4000 (500~8000)

Stream2

Resolution: 1280x720

Codec: H264

Frame Rate: 25 (1~25)

GOP Length: 25 (1~50)

Rate Control: CBR

CBR BitRate: 4000 (500~8000)

Stream3

Resolution: 800x600

Codec: H264

Frame Rate: 25 (1~25)

GOP Length: 25 (1~50)

Rate Control: CBR

CBR BitRate: 4000 (500~8000)

FIGURE 3-4: BASIC SETTINGS - CODEC

Edit Profile

This unit offers two choices of video codecs for real-time viewing: H.264 or M-JPEG. Click codec to change desired setting as below. By default, there are 6 compression profiles can be chose for respective resolution, frame rate, and picture quality as required. Be sure to click save to keep the desired setting.

TABLE 3-1: EDIT PROFILE OPTIONS

(ADC1800F-D111)

Item	Option	Description
Video Codec	M-JPEG/H.264	Set a default codec
Resolution	2048x1536 1080p(1920x1080) SXGA(1280x960) 720P(1280x720) SVGA(800x600) D1(720x480 / 720x576) 4CIF(704x480 / 704x576) VGA(640x480) CIF(352x240 / 352x288)	While 2048x1536 is the highest resolution, CIF is the lowest resolution.
Frame Rate	NTSC: 1~30	Frame rate is based on second. NTSC: H.264 or M-JPEG single stream: 2048x1536; H. 264 single stream:2304x1296, 1080p(1920x1080)@30fps, 3M(2048x1536)@15fps
Bit Rate Mode	Variable Bit Rate/Constant Bit Rate	Choose the bit rate control selection based on user requirements. A higher bit rate will use higher network bandwidth
GOP	1-64	Select the GOP (Group of pictures) number from 1 to 64. Recovery of the lost frames will be more difficult as the number gets bigger; on the contrary, it will increase the bite rate obviously and aggravate the network bandwidth. The default value is 30. GOP will be differed by frame rate setting.

(ADC1600F-D111)

Item	Option	Description
Video Codec	M-JPEG/H.264	Set a default codec
Resolution	720P(1280×720) SVGA(800×600) D1(720×480 / 720×576) 4CIF(704×480 / 704×576) VGA(640×480) CIF(352×240 / 352×288)	
Frame Rate	NTSC: 1~30	Frame rate is based on second. NTSC: H.264 or M-JPEG single stream:1280×720@30fps.
Bit Rate Mode	Variable Bit Rate/Constant Bit Rate	Choose the bit rate control selection based on user requirements. A higher bit rate will use higher network bandwidth
GOP	1-64	Select the GOP (Group of pictures) number from 1 to 64. Recovery of the lost frames will be more difficult as the number gets bigger; on the contrary, it will increase the bite rate obviously and aggravate the network bandwidth. The default value is 30. GOP will be differed by frame rate setting.

TABLE 3-2: CORRELATIONS OF RESOLUTION/STREAMS/FPS/CODECS 1/2

(ADC1800F-D111)

Resolution	Single stream	Double stream	Triple stream
2048x1536	2048x1536 @ 15fps (H.264/M-JPEG)	N/A	N/A
1920x1080	1920x1080 @ 30fps (H.264*/M-JPEG)	1920x1080, 720x480 @ 30fps* 1920x1080, 640x480 @ 30fps* 1920x1080, 352x240 @ 30fps* (H.264*, H.264/M-JPEG*)	1920x1080, 352x240, 352x240 @ 30fps (H.264, H.264/M-JPEG, H.264/M-JPEG)
1280x960	1280x960 @ 30fps (H.264/M-JPEG)	1280x960, 1280x720 @ 30fps 1280x960, 800x600 @ 30fps 1280x960, 720x480 @ 30fps 1280x960, 704x480 @ 30fps 1280x960, 640x480 @ 30fps 1280x960, 352x240 @ 30fps (H.264/M-JPEG, H.264/M-JPEG)	1280x960, 1280x720, 352x240 @ 30fps 1280x960, 800x600, 800x600 @ 30fps 1280x960, 800x600, 720x480 @ 30fps 1280x960, 800x600, 704x480 @ 30fps 1280x960, 800x600, 640x480 @ 30fps 1280x960, 800x600, 352x240 @ 30fps 1280x960, 720x480, 720x480 @ 30fps 1280x960, 720x480, 704x480 @ 30fps 1280x960, 720x480, 640x480 @ 30fps 1280x960, 720x480, 352x240 @ 30fps 1280x960, 704x480, 704x480 @ 30fps 1280x960, 704x480, 640x480 @ 30fps 1280x960, 704x480, 352x240 @ 30fps 1280x960, 640x480, 640x480 @ 30fps 1280x960, 640x480, 352x240 @ 30fps 1280x960, 352x240, 352x240 @ 30fps (H.264/M-JPEG, H.264/M-JPEG, H.264/M-JPEG)
1280x720	1280x720 @ 30fps (H.264/M-JPEG)	1280x720, 1280x720 @ 30fps** 1280x720, 800x600 @ 30fps 1280x720, 720x480 @ 30fps 1280x720, 704x480 @ 30fps 1280x720, 640x480 @ 30fps 1280x720, 352x240 @ 30fps** (H.264**/M-JPEG, H.264/M-JPEG**)	1280x720, 1280x720, 800x600 @ 30fps 1280x720, 1280x720, 720x480 @ 30fps 1280x720, 1280x720, 704x480 @ 30fps 1280x720, 1280x720, 640x480 @ 30fps 1280x720, 1280x720, 352x240 @ 30fps 1280x720, 800x600, 800x600 @ 30fps 1280x720, 800x600, 720x480 @ 30fps 1280x720, 800x600, 704x480 @ 30fps 1280x720, 800x600, 640x480 @ 30fps 1280x720, 800x600, 352x240 @ 30fps 1280x720, 720x480, 720x480 @ 30fps 1280x720, 720x480, 704x480 @ 30fps 1280x720, 720x480, 640x480 @ 30fps 1280x720, 720x480, 352x240 @ 30fps 1280x720, 704x480, 704x480 @ 30fps 1280x720, 704x480, 640x480 @ 30fps 1280x720, 704x480, 352x240 @ 30fps 1280x720, 640x480, 640x480 @ 30fps 1280x720, 640x480, 352x240 @ 30fps** 1280x720, 352x240, 352x240 @ 30fps (H.264**/M-JPEG, H.264/M-JPEG**, H.264**/M-JPEG)

*Profile 1, 2, & 3 defaults.

**Profile 4, 5, & 6 defaults.

TABLE 3-3: CORRELATIONS OF RESOLUTION/STREAMS/FPS/CODECS 2/2

Resolution	Single stream	Double stream	Triple stream
800x600	800x600 @ 30fps (H.264/M-JPEG)	800x600, 800x600 @ 30fps 800x600, 720x480 @ 30fps 800x600, 704x480 @ 30fps 800x600, 640x480 @ 30fps 800x600, 352x240 @ 30fps (H.264/M-JPEG, H.264/M-JPEG)	800x600, 800x600, 800x600 @ 30fps 800x600, 800x600, 720x480 @ 30fps 800x600, 800x600, 704x480 @ 30fps 800x600, 800x600, 640x480 @ 30fps 800x600, 800x600, 352x240 @ 30fps 800x600, 720x480, 720x480 @ 30fps 800x600, 720x480, 704x480 @ 30fps 800x600, 720x480, 640x480 @ 30fps 800x600, 720x480, 352x240 @ 30fps 800x600, 704x480, 704x480 @ 30fps 800x600, 704x480, 640x480 @ 30fps 800x600, 704x480, 352x240 @ 30fps 800x600, 640x480, 640x480 @ 30fps 800x600, 640x480, 352x240 @ 30fps 800x600, 352x240, 352x240 @ 30fps (H.264/M-JPEG, H.264/M-JPEG, H.264/M-JPEG)
720x480 / 720x576	720x480 @ 30fps (H.264/M-JPEG)	720x480, 720x480 @ 30fps 720x480, 704x480 @ 30fps 720x480, 640x480 @ 30fps 720x480, 352x240 @ 30fps (H.264/M-JPEG, H.264/M-JPEG)	720x480, 720x480, 720x480 @ 30fps 720x480, 720x480, 704x480 @ 30fps 720x480, 720x480, 640x480 @ 30fps 720x480, 720x480, 352x240 @ 30fps 720x480, 704x480, 704x480 @ 30fps 720x480, 704x480, 640x480 @ 30fps 720x480, 704x480, 352x240 @ 30fps 720x480, 640x480, 640x480 @ 30fps 720x480, 640x480, 352x240 @ 30fps 720x480, 352x240, 352x240 @ 30fps (H.264/M-JPEG, H.264/M-JPEG, H.264/M-JPEG)

(ADCi600F-D111)

Resolution	Single Stream	Dual Stream	Triple Stream
1280x720	1280x720 @ 30fps (H.264/MJPEG)	1280x720, 1280x720 @ 30fps 1280x720, 800x600 @ 30fps 1280x720, 720x480 @ 30fps 1280x720, 704x480 @ 30fps 1280x720, 640x480 @ 30fps 1280x720, 352x240 @ 30fps (H.264/MJPEG, H.264/MJPEG)	1280x720, 1280x720, 352x240 @ 30fps 1280x720, 800x600, 800x600 @ 30fps 1280x720, 800x600, 720x480 @ 30fps 1280x720, 800x600, 704x480 @ 30fps 1280x720, 800x600, 640x480 @ 30fps 1280x720, 800x600, 352x240 @ 30fps 1280x720, 720x480, 720x480 @ 30fps 1280x720, 720x480, 704x480 @ 30fps 1280x720, 720x480, 640x480 @ 30fps 1280x720, 720x480, 352x240 @ 30fps 1280x720, 704x480, 704x480 @ 30fps 1280x720, 704x480, 640x480 @ 30fps 1280x720, 704x480, 352x240 @ 30fps 1280x720, 640x480, 640x480 @ 30fps 1280x720, 640x480, 352x240 @ 30fps 1280x720, 352x240, 352x240 @ 30fps (H.264/MJPEG, H.264/MJPEG, H.264/MJPEG)
800x600	800x600 @ 30fps (H.264/MJPEG)	800x600, 800x600 @ 30fps 800x600, 720x480 @ 30fps 800x600, 704x480 @ 30fps 800x600, 640x480 @ 30fps 800x600, 352x240 @ 30fps (H.264/MJPEG, H.264/MJPEG)	800x600, 800x600, 800x600 @ 30fps 800x600, 800x600, 720x480 @ 30fps 800x600, 800x600, 704x480 @ 30fps 800x600, 800x600, 640x480 @ 30fps 800x600, 800x600, 352x240 @ 30fps 800x600, 720x480, 720x480 @ 30fps 800x600, 720x480, 704x480 @ 30fps 800x600, 720x480, 640x480 @ 30fps 800x600, 720x480, 352x240 @ 30fps 800x600, 704x480, 704x480 @ 30fps 800x600, 704x480, 640x480 @ 30fps 800x600, 704x480, 352x240 @ 30fps 800x600, 640x480, 640x480 @ 30fps 800x600, 640x480, 352x240 @ 30fps 800x600, 352x240, 352x240 @ 30fps (H.264/MJPEG, H.264/MJPEG, H.264/MJPEG)

3.2.1.2 Exposure

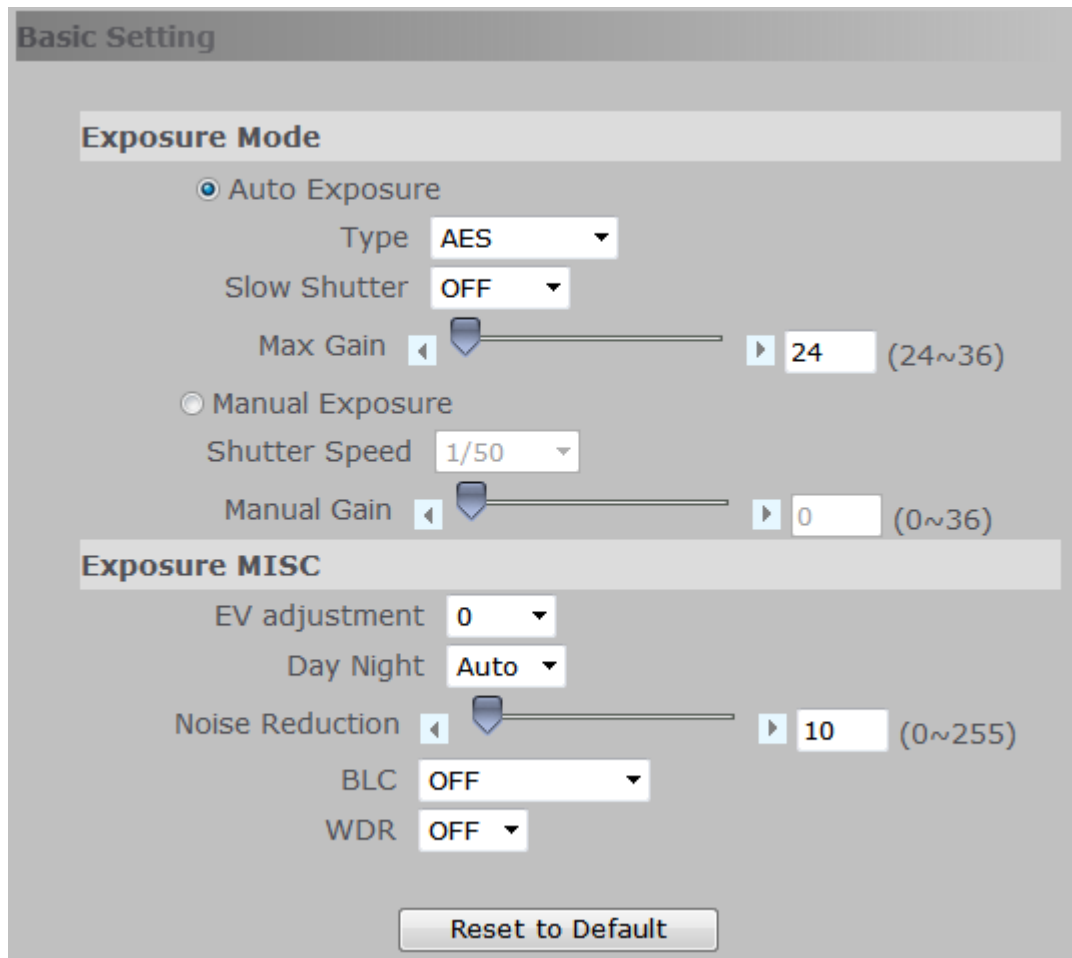

FIGURE 3-5: BASIC SETTINGS – EXPOSURE

Automatic Exposure

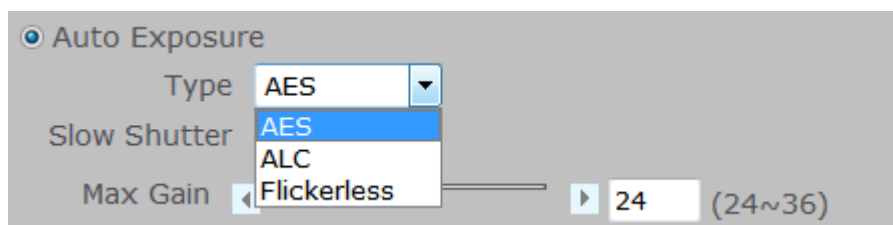

FIGURE 3-6: AUTOMATIC EXPOSURE SETTING

Automatic Exposure controls the light intensity of picture. There are three options, AES (Automatic Electronic Shutter), ALC, and Flickerless, to adjust for adjustment depending on conditions.

Slow Shutter

Slow Shutter can be enabled if the sensitivity is still not good enough under “High” gain condition at dark. Optimal image level can be maintained by appropriate gain and shutter combination that determined automatically inside the unit system. Slow Shutter can be selected from OFF, 1/30, 1/15, and 1/7.5. As slow shutter activates, the exposure time becomes longer and frame rate becomes smaller, and moving objects may result in blurred images.

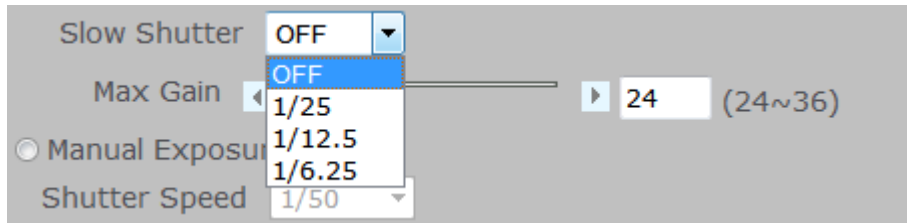

FIGURE 3-7: SLOW SHUTTER SETTING

Max Gain

Set max gain. You can drag the bar to adjust gain level from 0 to 36.



FIGURE 3-8: MAX GAIN SETTING

Manual Exposure

Select this option to manually define exposure values of the unit.

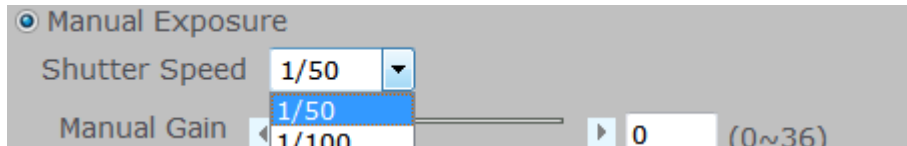

FIGURE 3-9: MANUAL EXPOSURE SETTING

Shutter Speed

Set desired Shutter Speed from 1/60s to 1/8000s. When broadcast TV system is set to PAL, the Shutter Speed can be set at 1/50, 1/100, 1/250, 1/500, 1/1000, 1/2000, 1/4000, or 1/8000s; when NTSC, 1/60, 1/120, 1/250, 1/500, 1/1000, 1/2000, 1/4000, or 1/8000s. The unit will adjust the aperture according to the amount of ambient light. Selecting 1/8000s provides the dark image.

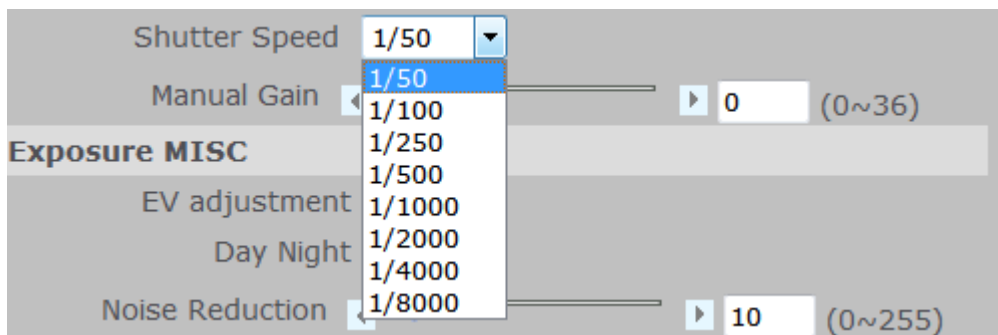

FIGURE 3-10: SHUTTER SPEED SETTING

Manual Gain

Set Manual Gain value from 0 to 36dB. This function applies to manual lens only. 36dB brightens the image and 0dB darkens the image.



FIGURE 3-11: MANUAL GAIN SETTING

EV Adjustment

EV Adjustment can be set between 2.0 to -2.0.

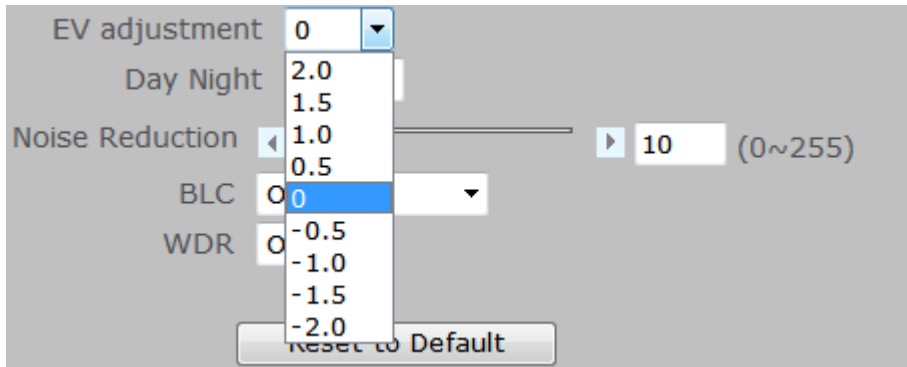

FIGURE 3-12: EV ADJUSTMENT SETTING

Day Night

To set DAY/NIGHT function, simply move the cursor to select Auto, Color, or BW mode. If Color selected, the unit is forced to stay in COLOR mode all day. If BW selected, the unit is forced to stay in NIGHT mode all day.



FIGURE 3-13: DAY NIGHT SETTING

Noise Reduction

Noise reduction is the process of removing noise from signal. Users can configure the noise reduction related setting 0~255 to reduce noise on the screen. Selecting 255 provides the best image without noise.



FIGURE 3-14: NOISE REDUCTION SETTING

BLC (Backlight Compensation)

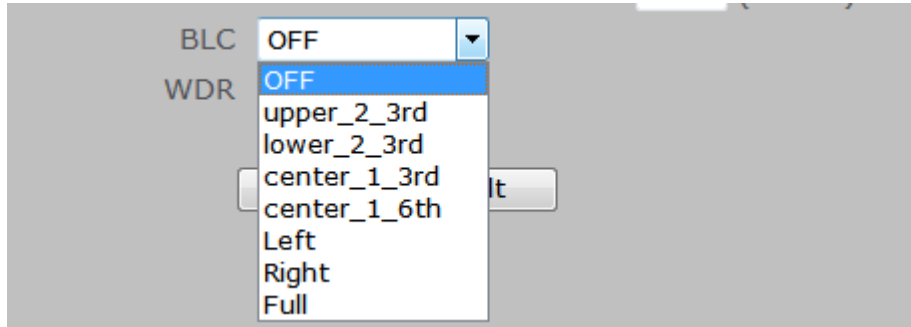

FIGURE 3-15: BACKLIGHT COMPENSATION SETTING

Set an area for Backlight Compensation. Backlight Compensation is a function that achieves the brightness of a selected area to optimal image level. This function is necessary when an auto iris lens tends to close due to an intense light coming from back of object in the area wished to view so that the area is too dark and difficult to see. In this case, users may set the area correspond to the portion wished to see. The area size illustrations are roughly as follows.

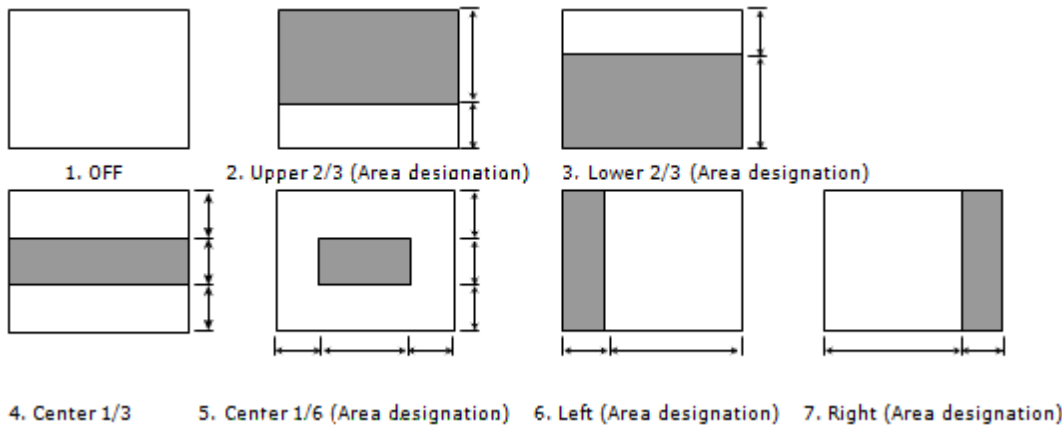

FIGURE 3-16: BACKLIGHT COMPENSATION PICTURE SETTING

WDR (Wide Dynamic Range)

It is intended to provide clear images even under backlight circumstances where intensity of illumination can vary excessively namely where there are both very bright and very dark areas simultaneously in the field of view. WDR enables the capture and display of both bright and dark areas in the same frame, in a way that there are details in both areas, i.e. bright areas are not saturated, and dark areas are not too dark.

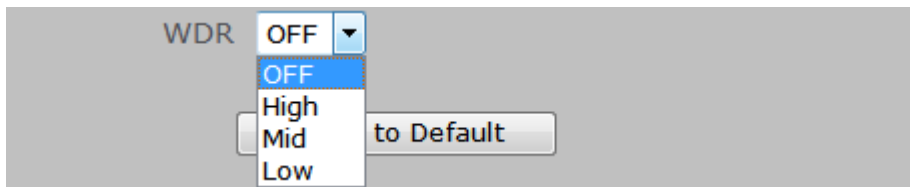

FIGURE 3-17: WDR SETTING

Note Please click “Save” button to save your settings. Users can also click “Reset to Default” to set all the data and options back to defaults.

3.2.1.3 White Balance

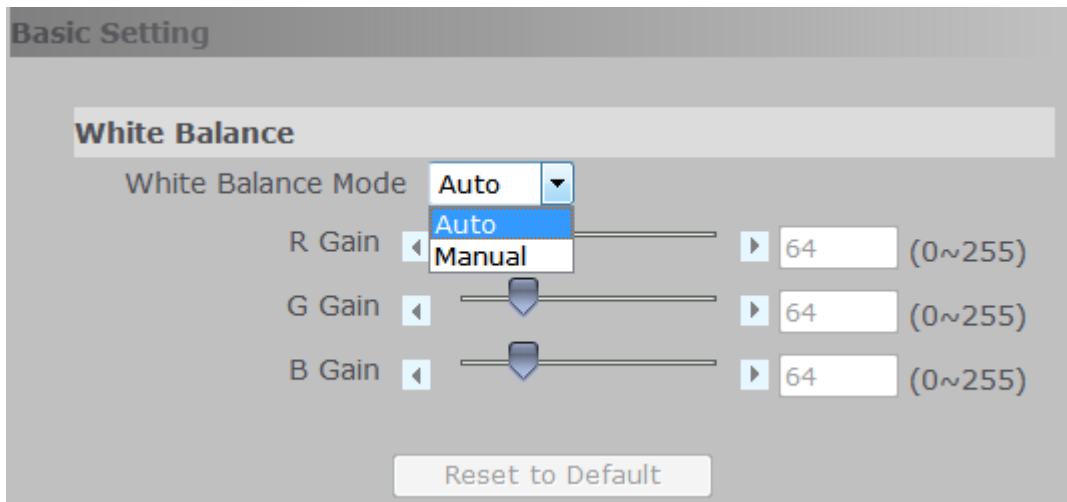

FIGURE 3-18: WHITE BALANCE SETTING

- White Balance controls color on the screen. Mode can be set to Auto (default) or Manual mode. The color temperature range is 2800°K ~ 8500°K.
- Set manual gain value of R Gain, G Gain, & B Gain from level 0 to 255.
 - The red (R) gain is used to adjust the color red in the viewing image. It allows adjusting red gain manually according to user requirement ranging from level 0 to 255.
 - The green (G) gain is used to adjust the color of green in the viewing image. It allows adjusting green gain manually according to user requirement ranging from level 0 to 255.
 - The blue (B) gain is used to adjust the color of blue in the viewing image. It allows adjusting blue gain manually according to user requirement ranging from level 0 to 255.

3.2.1.4 Basic Color

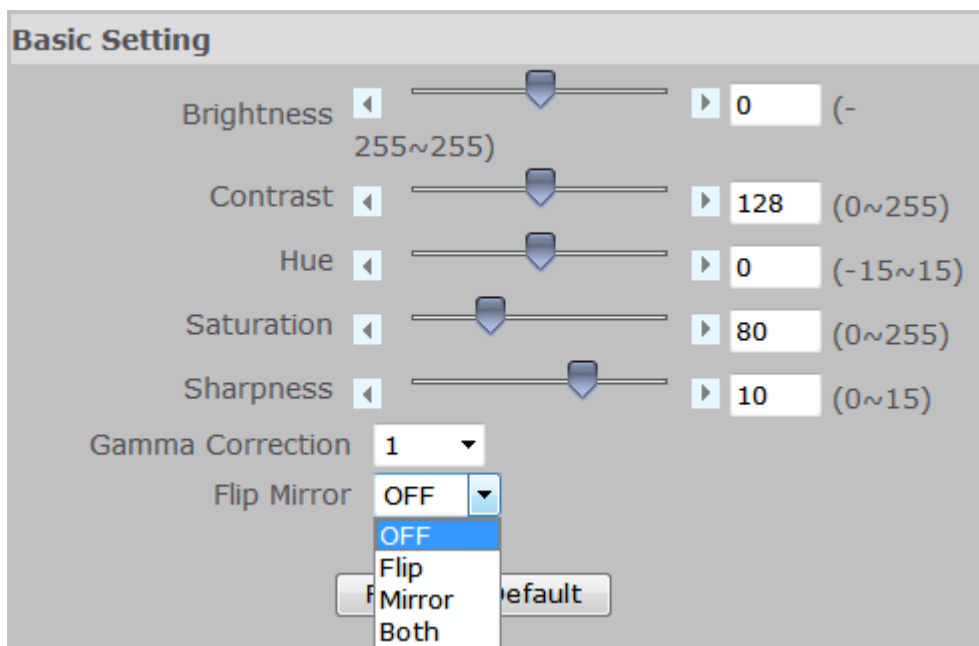

FIGURE 3-19: BASIC COLOR SETTING

Brightness adjustment

Set picture brightness from level -255 to 255. Selecting 255 provides brightest the image.

Contrast

Set picture contrast from level 0 to 255. Selecting 255 provides highest contrast.

Hue

Set picture hue from level -15~15. Selecting 15 provides the deep hue.

Saturation

Saturation describes the difference of a color from the gray of the same lightness. Increasing saturation deepens the colors of your images, making reds redder and blues bluer. Users can adjust picture saturation level from 0 to 255. Decreasing saturation brings the image closer to a grayscale (that is, monochrome or black-and-white) image. Selecting 255 provides highest image saturation.

Sharpness

Increasing the sharpness value will sharpen the edges and small feature of viewing images. If the edges appear too smooth or blurred, increase the sharpness; otherwise, decrease the sharpness. Sharpness value can be set from 0 to 15. Selecting 15 provides the sharpest image.

Gamma Correction

Set gamma correction. You can select “1” or “0.45”.

Flip Mirror

Set image to be left or right, upside or down and both. Select “OFF”, “Flip”, “Mirror” or” Both” to activate or deactivate the mirror function.

Note Please click “Save” button to save your settings. Users can also click “Reset to Default” to set all the data and options back to defaults.

3.2.1.5 Privacy Zone

Privacy Color Setting

Users can select a desire color for the privacy zone color.

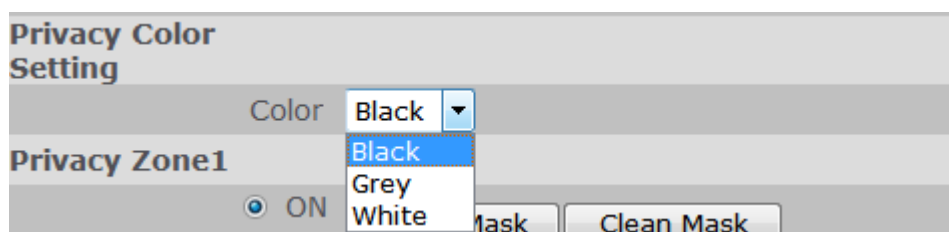

FIGURE 3-20: PRIVACY COLOR SETTING

Privacy Zone Setting

- Enable button “ON”, then to start mask setting.
- Use mouse to drag a mask rectangle on the screen, click “Save Mask Zone” to complete the selection.
- To cancel the mask setting simply clicks “Clean Mask Zone”.

Note At max 8 masks can be set on the screen.

Caution The privacy zone area is a factor increased by 16. That implies we have to round the length and width of the privacy zone to meet this rule. After rounding the algorithm, the result of privacy zone will be plus or minus 16% of the user selected area.

The screenshot displays a control panel for eight privacy zones. Each zone is represented by a header (Privacy Zone1 through Privacy Zone8) followed by a row containing a radio button for 'ON' (selected) and 'OFF', and two buttons labeled 'Save Mask' and 'Clean Mask'.

FIGURE 3-21: PRIVACY ZONE SETTING



FIGURE 3-22: PRIVACY ZONE DIAGRAM

3.2.2 Network Settings

Below explains how to configure a wired network connection for the unit.

The screenshot displays the 'Basic Setting' menu with three sub-sections: Network, UPNP, and OSD. The Network section includes fields for Camera Name (illustra-flex), DHCP (unchecked), IP Address (192.168.1.168), Subnet Mask (255.255.255.0), Default Gateway (192.168.1.254), Primary DNS (0.0.0.0), and Secondary DNS (0.0.0.0). The UPNP section has an Action radio button set to ON. The OSD section has radio buttons for Camera Name and Date & Time, both set to OFF. A Save button is located at the bottom of the OSD section.

FIGURE 3-23: NETWORK SETTINGS

- Camera Name: Enter a desired camera name or use the default name.
- DHCP: If selected, the unit will automatically obtain an available dynamic IP address from the DHCP server each time it connects to the LAN.
- IP Address: Manually input IP address when DHCP off selected.
- Subnet Mask: Please use default number: 255.255.255.0. If the subnet mask is not properly configured, the unit may not be able to communicate with other devices on the network.
- Default Gateway: Leave blank as default setting. It is not necessary to enter Default Gateway if it is not used. Ask your Network Administrator for Default Gateway information.
- Primary DNS: (same as above)
- Secondary DNS: (same as above)
- OSD: When set to "ON", the camera name can be show on the screen.

3.2.2.1 FTP

In this page, users can activate a FTP Server to reach SD card for recordings.

- Simply click “OFF” to disable the FTP function.
- Simply click “ON” to activate the FTP function, and follow the following procedures to set up related settings.
- Enter a login ID if activated the FTP function.
- Enter a password associated with the login ID.
- Re-enter the password to confirm it.
- Determine the number of maximum connections by key-in a number in the Max Simultaneous Connections field. Note: This is the maximum of FTP Client connections, not the maximum of IE Window’s connections.

To log on the FTP, simply enter ftp://<Login ID>:<Password>@<ip address> in the location field of Microsoft’s Internet Explorer and the recordings will be shown up. The default setting is <ftp://admin:admin@192.168.1.168>. Refer to the names of file and the folder for date and time of recordings.

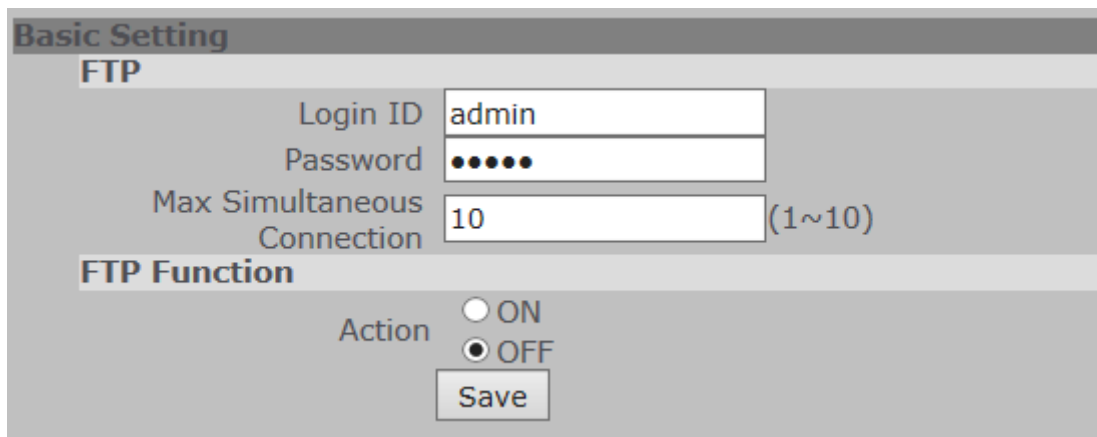

FIGURE 3-24: FTP SETTINGS

Note Please click “Save” button to save your settings. Users can also click “Reset to Default” to set all the data and options back to defaults.

3.2.2.2 RTSP

To enable RTSP, simply enter the Login ID, Password, and Multicast Address, and then select “ON” in Authentication.

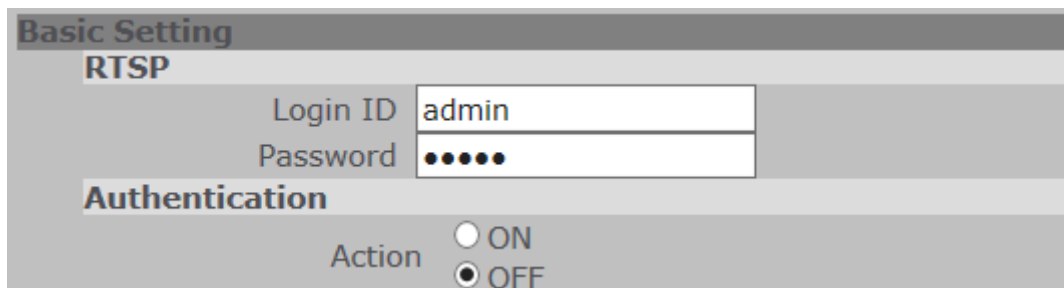

FIGURE 3-25: RTSP & AUTHENTICATION SETTINGS

RTSP Stream1

Transfer Type: Unicast

URL: stream1

Multicast Address: 231.8.8.200
(224.0.1.1~239.255.255.254)

Metadata: OFF

RTSP Stream2

Transfer Type: Unicast

URL: stream2

Multicast Address: 231.8.8.210
(224.0.1.1~239.255.255.254)

Metadata: OFF

RTSP Stream3

Transfer Type: Unicast

URL: stream3

Multicast Address: 231.8.8.220
(224.0.1.1~239.255.255.254)

Metadata: OFF

Save Reset to Default

FIGURE 3-26: RTSP Stream1 / Stream2 / Stream 3 SETTINGS

- **Multicast Address**

The IP address for multicasting ought to be from 224.0.1.1 to 239.255.255.254. After desired options and values are chosen, please be remembered to click “save” button to save all settings.

Note: RTSP URLs for RTSP Stream 1, RTSP Stream 2, and RTSP Stream3 are: rtsp://(ip address)/(stream 1), rtsp://(ip address)/(stream 2), rtsp://(ip address)/(stream 3) respectively.

For example: rtsp://192.168.1.168/stream1

- **Metadata**

Metadata plays a significant role for media applications especially for ONVIF compatible NVR.

Turn on the metadata option and there will be an additional track in the RTSP connection response message. The additional track name is “vnd.onvif” and this track is for event data transmission. Once if the event(motion, alarm) is triggered, RTSP server will transmit event data to RTSP client(usually NVR). RTSP client can receive these data and analyze them. The event data usually includes event trigger time, coordinate...etc.

3.2.2.3 SNMP

SNMP (Simple Network Management Protocol) is an Internet standard protocol on top of application layer that restructures the exchange of management information among network-attached nodes, which helps administrators to remotely manage network devices and master network problems with ease.

The screenshot displays the SNMP configuration interface with the following sections and settings:

- SNMP V1:** Enable ON, OFF
- SNMP V2:** Enable ON, OFF
- SNMP V3:** Enable ON, OFF; User Name: initial; Password: [masked]
- Read / Write Community String:** Read Community String: public; Write Community String: private
- Trap:** Enable ON, OFF; Trap Host: 192.168.0.20
- Heartbeat:** Enable ON, OFF; Heartbeat Host: 192.168.0.20; Heartbeat Interval: 30

FIGURE 3-27: SNMP SETTINGS 1/2

- SNMP V1: Tick “ON” or “OFF” to enable or disable.
- SNMP V2: Tick “ON” or “OFF” to enable or disable.
- SNMP V3: Tick “ON” or “OFF” to enable or disable. Enter password corresponding to User Name. SNMPv3 provided more security features to SNMP.
- Read/Write Community String: Enter the names of Read Community and Write Community.
- Trap: Tick “ON” or “OFF” to enable or disable. Input IP address of Trap Host.
- Heartbeat: Tick “ON” or “OFF” to enable or disable. Input IP address & Interval of Heartbeat Host & Heartbeat.

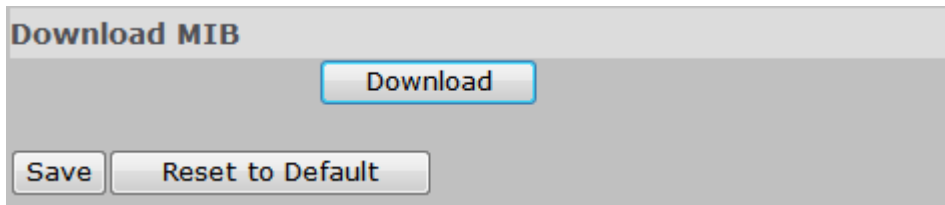

FIGURE 3-28: SNMP SETTINGS 2/2

- **Download:** Click “Download” to get specifics of MIB (Management Information Base). MIBs describe the structure of the management data of a device subsystem; they use a hierarchical namespace containing object identifiers (OID). Each OID identifies a variable that can be read or set via SNMP.

Note Please click “Save” button to save your settings. Users can also click “Reset to Default” to set all the data and options back to defaults.

3.2.3 System Settings

3.2.3.1 Date & Time

Synchronization Mode

Synchronization supports three different modes: Manual, Computer Clock, and NTP Server.

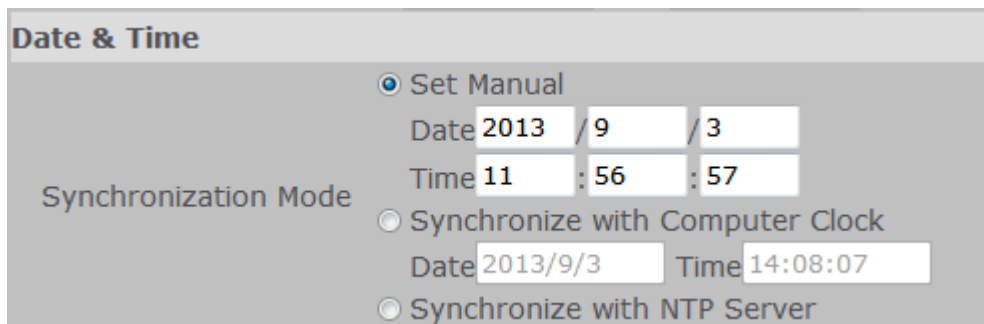

FIGURE 3-29: SYNCHRONIZATION MODE SETTINGS

Set manual: Set up the date and time of the unit in the Date and Time field manually.

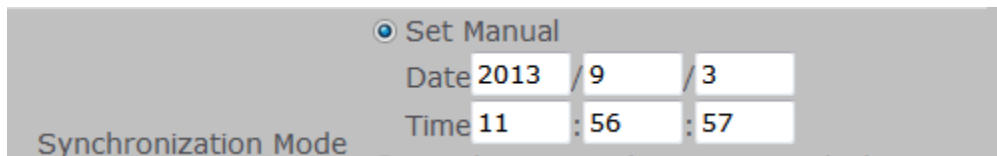

FIGURE 3-30: SET MANUAL SETTINGS

Synchronize with Computer Clock: Select this one to synchronize the date and time of the unit with the computer clock.

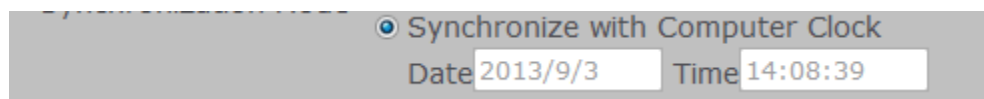

FIGURE 3-31: SYNCHRONIZATION WITH COMPUTER CLOCK SETTINGS

Synchronize with NTP Server: Select NTP in the Synchronization Mode to synchronize the date and time with the dedicated

- NTP Server: Input IP address or URL of the dedicated NTP server. Note: Please make sure disable SD recording function before you enable NTP synchronization mode.
- NTP Synchronize Period: Select interval to synchronize with the NTP server.
- NTP Time Adjustment Test: Press the button to test synchronization with the dedicated NTP server.

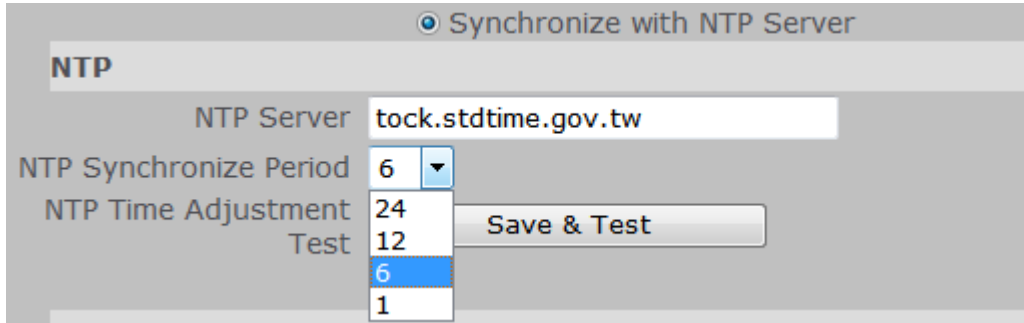

FIGURE 3-32: NTP SETTINGS

DST

Time Zone: Select the time difference between Greenwich Mean Time and where the unit is located.

Daylight Saving: Tick “Daylight Saving” to enable the daylight-saving function if in a daylight saving time zone (effective in NTP mode only).

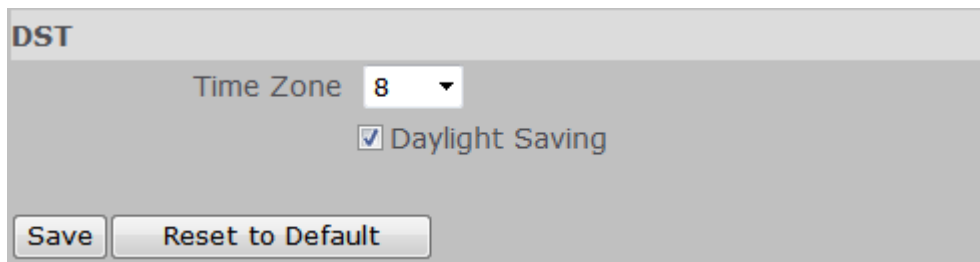

FIGURE 3-33: DST SETTINGS

Note Please click “Save” button to save your settings. Users can also click “Reset to Default” to set all the data and options back to defaults.

3.2.3.2 User Management

Press the item-user management on setting menu, and system password and language (only including English) can be setup. The default setting for system Admin ID, password, and language are admin, admin, and English respectively; however, desired Admin ID and password can be entered at this field.

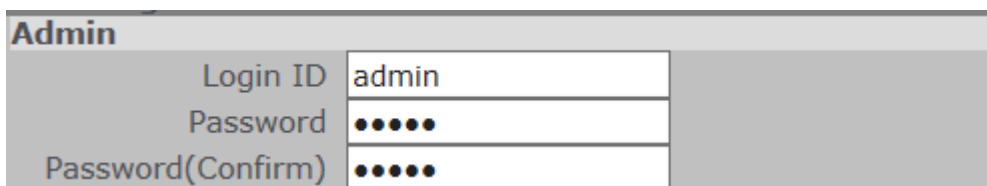

FIGURE 3-34: ADMIN SETTINGS

Besides administrator, guests can access the unit under authorization from system administrator by privilege controller. User1~5 are allowed to review the live picture only. No operation will be enforced without any authorization. The default login name and password of guests are “user 1” (user+ 1~5) and “0000”; however, desired login name and password of guests may be altered like those of administrator’s.

FIGURE 3-35: GUEST SETTINGS

Caution The login ID and Password is supported max 32 characters. Only space key is invalid.

Finally, click Save to keep the settings.

3.2.3.3 Audio

Audio setting can be setup by enabling audio input and output.

Audio Input

Type: Select one of the two audio compression coding, G711a or G711u.

Audio Input: Set to "ON" when receiving audio from a microphone connected to the unit.

Audio Input Level: Select among High, Mid, and Low for input level.

FIGURE 3-36: AUDIO SETTINGS

Audio Output

Audio Output: Set to "ON" when delivering audio to a speaker connected to the unit.

Audio Output Level: Select among High, Mid, and Low for output level.

Note Please click “Save” button to save your settings. Users can also click “Reset to Default” to set all the data and options back to defaults.

3.2.3.4 Firmware

System Information about Firmware Version, Mac Address, MCU Version, and Model Name are revealed here as below figure. Users can update system firmware if available. All camera motions will shut down during firmware update. Please close any other screens before firmware update. Never disconnect power or LAN cable during the firmware update process. It takes approximately 3 minutes for the unit to reboot after firmware update process. Please reboot the computer as well after firmware update process. Again, power can't be lost when updating firmware since it will cause the update failure and manufacturer maintenance will be required.

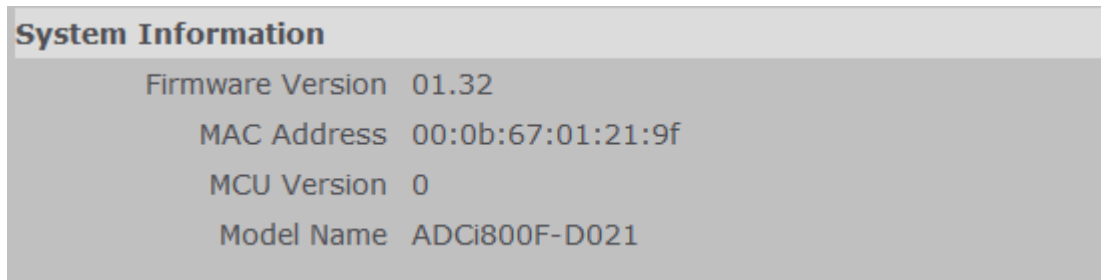

FIGURE 3-37: FIRMWARE UPDATE 1/2

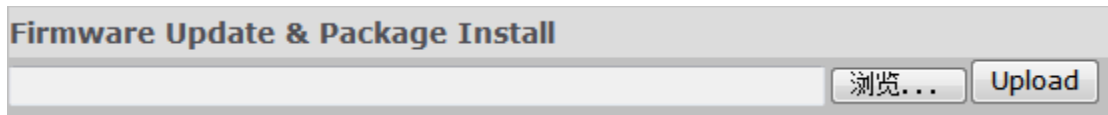

FIGURE 3-38: FIRMWARE UPDATE 2/2

3.2.3.5 Configuration

Video Type

Select "NTSC" or "PAL" as required. Flickering by fluorescent light can be reduced by selecting "PAL" if the power frequency is 50Hz, "NTSC", if 60Hz.

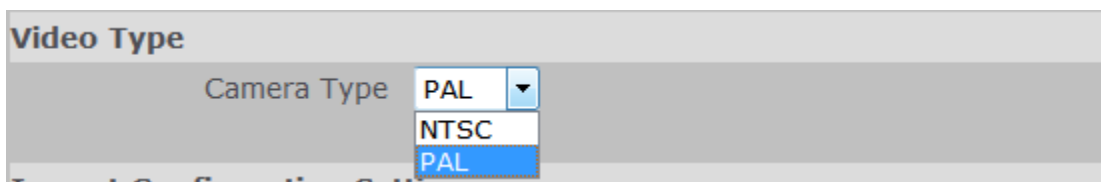

FIGURE 3-39: VIDEO TYPE SETTING

Import Configuration Settings

This function is designed to upload configuration setting from the client computer to the unit.

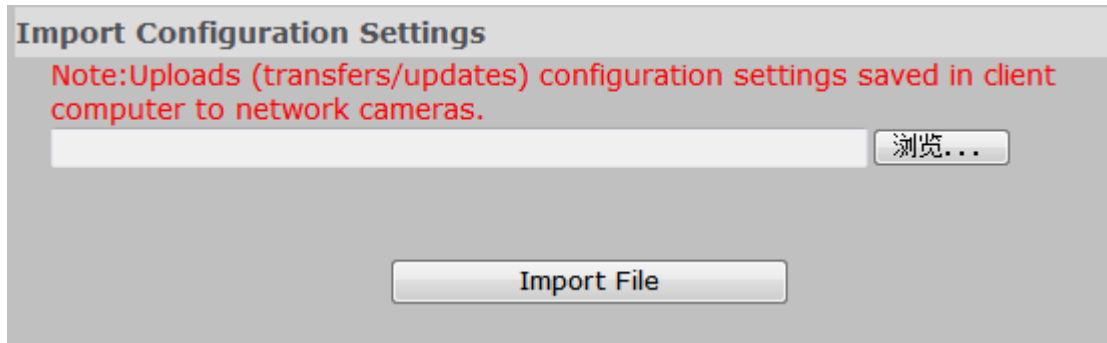

FIGURE 3-40: IMPORT CONFIGURATION SETTING

Export Configuration Settings

This function is designed to export configuration settings to the client computer.

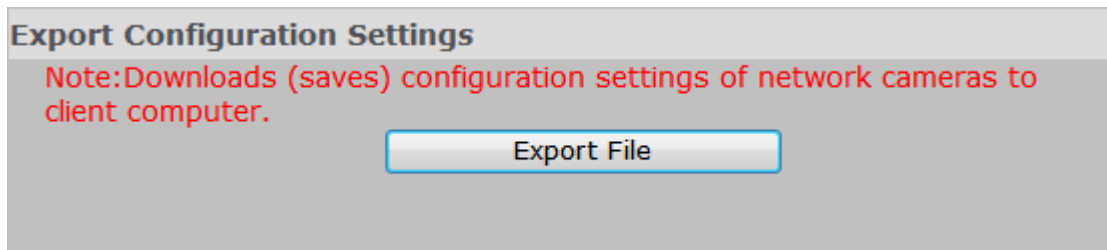

FIGURE 3-41: EXPORT CONFIGURATION SETTING

Configuration

This function is design to restart camera and reset all configuration settings back into factory default. Press "Software Factory Default" to reset all settings back to factory default excluding network setting. Press "Hardware Factory Default" to reset all settings back to factory default including network setting.

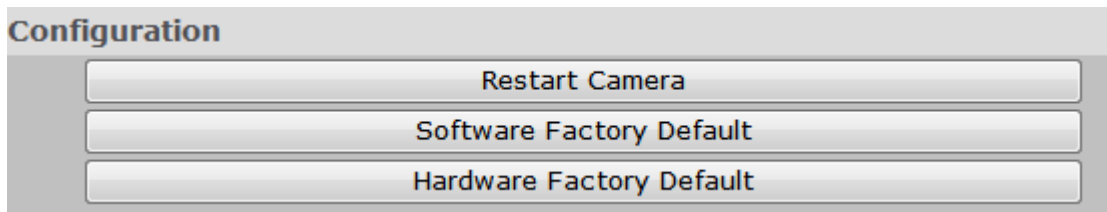

FIGURE 3-42: CONFIGURATION SETTING

3.2.4 Event Settings

3.2.4.1 Motion Detection

This function is designed to record video once the unit detects a motion.

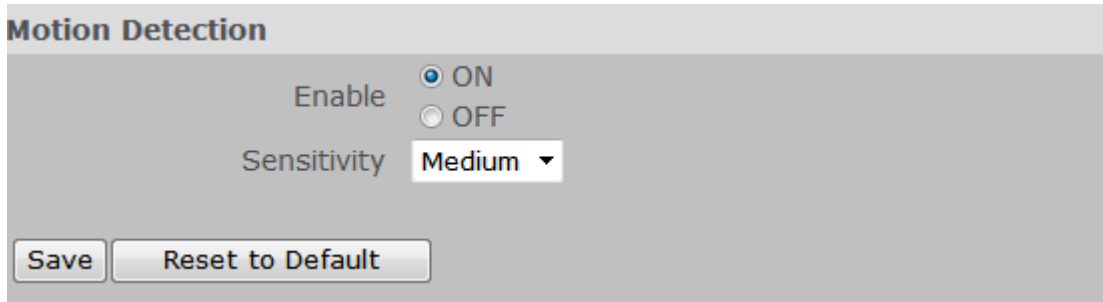

FIGURE 3-43: MOTION DETECTION SETTING 1/2

Enable: Select “ON” or “OFF” to use this function.

Sensitivity: Choose different levels of sensitivity from high, medium, and low. “High”: Motion is activated with slight changes in brightness or motion. “Low”: Motion is activated with big changes in brightness or motion.

Set Motion Area: Set the desired area to trigger motion detection. The motion setup screen will be popped out for defining the detection area by dragging the mouse.



FIGURE 3-44: MOTION DETECTION SETTING 2/2

3.2.4.2 Alarm

When an alarm is connected, the unit triggers an alarm only once the status (open or closed) changed. When an alarm event is detected, an alarm message would be displayed on the Web-Client screen for notification.

Alarm Input

Alarm Input: Set the Alarm Input as “ON” or “OFF”.

Input Type: Choose NO for normally open or NC for normally close. NO (Normally Opened): An alarm will be triggered when the external contact closes. NC (Normally Closed): An alarm will be triggered when the external contact opens.

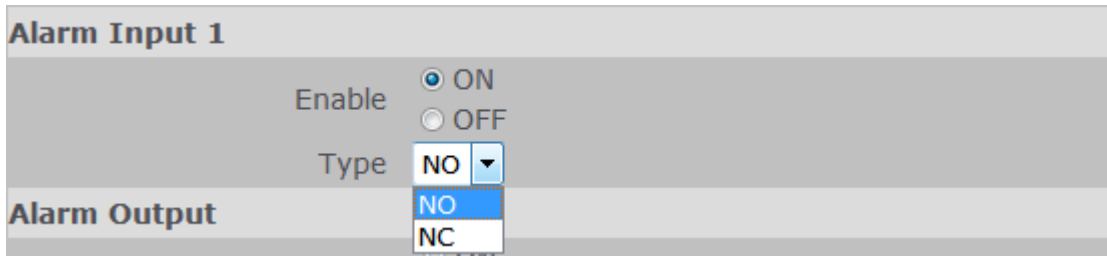

FIGURE 3-45: ALARM INPUT SETTING

Alarm Output

When the Mode is set to “On”, external devices such as sirens or flashing lights that connected to the alarm output connector will signal for alarm activation.

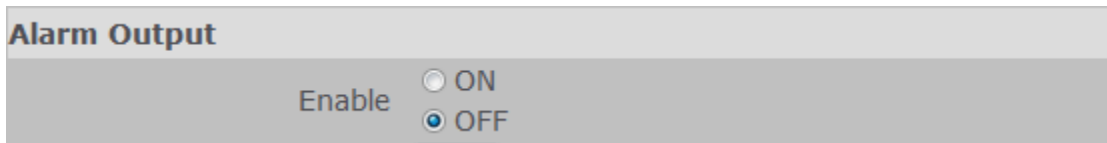

FIGURE 3-46: ALARM OUTPUT SETTING

Note Please click “Save” button to save your settings. Users can also click “Reset to Default” to set all the data and options back to defaults.

3.2.5 Record Settings

3.2.5.1 FTP Record

Recording Condition

Users can save image files via FTP by setting FTP recording condition beforehand.

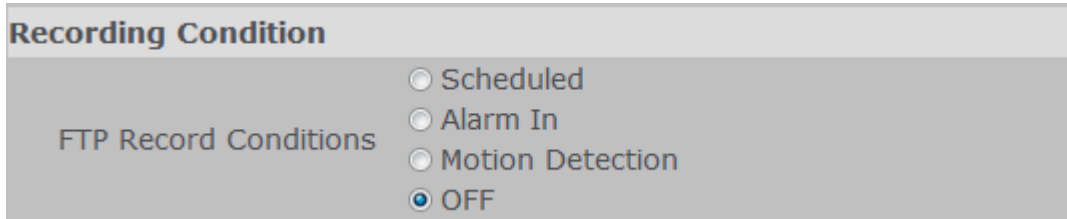

FIGURE 3-47: RECORDING CONDITION SETTING

Recording Condition: You can store your image files base on your scheduled recording, recording by alarm or recording by motion.

FTP Server

FTP (File Transfer Protocol) is used as a service component to transfer files by simply entering the FTP IP address or hostname with the Login ID and password.

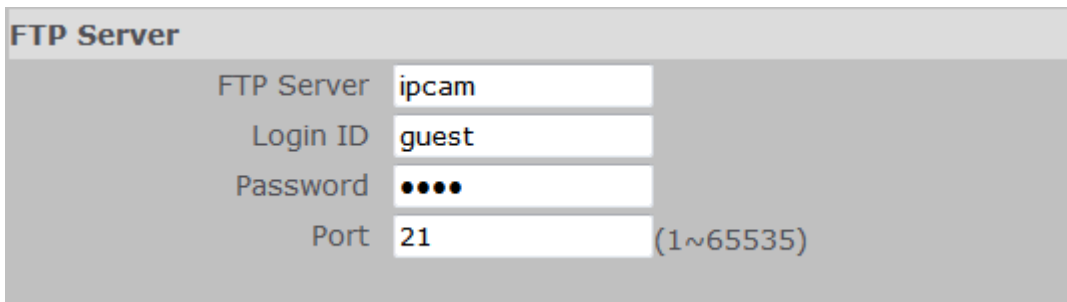

FIGURE 3-48: FTP SERVER SETTING

- FTP IP Address: Input a server name or address.
- Login ID: Input a user name with privilege to access the server.
- Password: Input the password associated with Login ID.
- FTP Port: Set “21” as default or change to dedicated number.

Note The default login name and password are “guest” and “1234”.

Scheduled Recording Table

Determine the recording condition: OFF, All Day, Scheduled 1, or Scheduled 2 from scheduled recording table during 24/7.

Day	OFF	All Day	Scheduled 1	Scheduled 2
Monday	<input checked="" type="radio"/>	<input type="radio"/>	<input type="radio"/>	<input type="radio"/>
Tuesday	<input checked="" type="radio"/>	<input type="radio"/>	<input type="radio"/>	<input type="radio"/>
Wednesday	<input checked="" type="radio"/>	<input type="radio"/>	<input type="radio"/>	<input type="radio"/>
Thursday	<input checked="" type="radio"/>	<input type="radio"/>	<input type="radio"/>	<input type="radio"/>
Friday	<input checked="" type="radio"/>	<input type="radio"/>	<input type="radio"/>	<input type="radio"/>
Saturday	<input checked="" type="radio"/>	<input type="radio"/>	<input type="radio"/>	<input type="radio"/>
Sunday	<input checked="" type="radio"/>	<input type="radio"/>	<input type="radio"/>	<input type="radio"/>

Schedule 1 Start	8	AM	- Stop	5	PM
Schedule 2 Start	8	AM	- Stop	5	PM
Recording Cycle	5 (Second)				
Record File Name	rec_sche				
Server Path	/cam				

FIGURE 3-49: SCHEDULED RECORDING TABLE

- Recording cycle: Set a time interval for recording images.

Recording Cycle	5	(Second)
Record File Name	5	ne
Server Path	30	
	60	
	90	
	120	

FIGURE 3-50: RECORDING CYCLE SETTING

- Server Path: Set the data path where the data is to be stored on the server.

Server Path	/cam
-------------	------

FIGURE 3-51: SERVER PATH SETTING

Alarm Settings & Motion Settings

These functions are to define the way to record video once a motion/alarm event is detected by the unit.

Alarm Setting	
Pre Recording Frame	0 ▾
Pre Recording Cycle	1 ▾ (Second)
Recording Frame	10 ▾
Recording Cycle	2 ▾ (Second)
File Name	rec_alarm
Server Path	/cam

Motion Setting	
Pre Recording Frame	0 ▾
Pre Recording Cycle	1 ▾ (Second)
Recording Frame	10 ▾
Recording Cycle	2 ▾ (Second)
File Name	rec_motion
Server Path	/cam

FIGURE 3-52: ALARM SETTINGS & MOTION SETTINGS

- Pre Recording Frame: Set the number of frame to be recorded immediately before a motion occurs.
- Pre Recording Cycle: Set a time interval before recording.
- Recording Frame: Set the number of frame when recording.
- Recording Cycle: Set a time interval for recording.

At last, press “Save” to keep the settings.

3.2.5.3 SD Record

Image files can be saved onto the SD card; nevertheless, this menu will not show up unless the SD card inserted.

Recording Condition

- Choose the condition of the SD recording on Alarm, Motion, Network Loss, or OFF.

Note Confined SD recording priority: Alarm → Motion → Network Loss → OFF

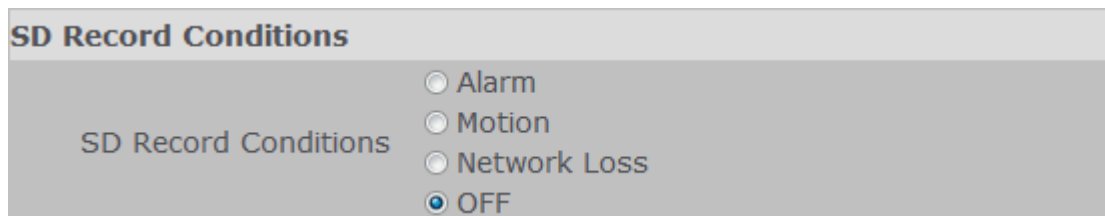

FIGURE 3-53: SD RECORDING CONDITIONS SETTINGS

- Set a time interval for alarm recording or motion recording.



FIGURE 3-54: SD RECORDING TIME INTERVAL SETTINGS

- Set overwrite 'OFF' or 'ON' to disable or enable the SD card to be overwritten automatically when the SD card is full of recordings.



FIGURE 3-55: SD RECORDING OVERWRITE SETTINGS

- Usage: Information of SD card usage.

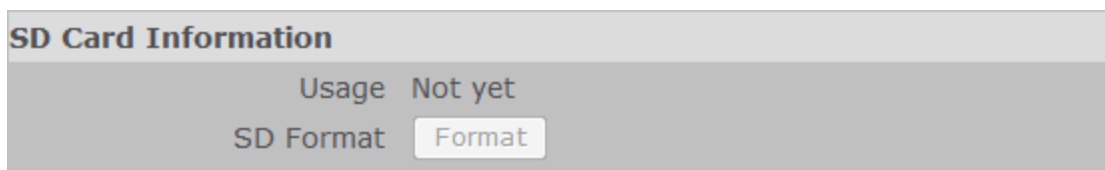

FIGURE 3-56: SD CARD INFORMATION

- SD Format: Click to erase information off of the SD card.

Appendix: Specification of Illustra Flex Indoor Dome

Model Type	Vari-focal Day/Night Indoor Dome Camera	
Model No.	ADCi800F-D111	ADCi600F-D111
Signal System	NTSC	NTSC
Warranty	1 year	
Image System		
Image Sensor	1/3" AR0330	
Sensor Type	CMOS	
Optical System		
Lens Mount	D19	
Auto Iris Control	DC Iris	
Focal Length	Vari-focal 3~9mm	
F No	1.2	
Angel Of View	Wide: 98°(H), 53°(V) Tele: 33°(H), 19°(V)	
Day/Night	Mechanical ICR	
Electric		
Digital Noise Reduction	3D	
Gamma Correction	0.45/1	
Minimum Illumination	F:1.2, CL: 0.3 lux @ 50IRE, B/W: 0.1 lux@ 50IRE, 1/30, Max. Gain	
S/N Ratio	50dB (AGC off)	
Gain Control	Off / On, Selectable	
White Balance	ATW(2800K~8500K) / Manual	
Electric Shutter	1/30~1/8000 sec	
Audio In/Out	Audio In/Out	
Video Output	Monitor Out	
Alarm In/Out	Alarm In x1 / Alarm Out x1	
On-board Storage	SDHC/SDXC	
Network Specifications		
Video Compress	H.264 / M-JPEG	
Video Streaming	Triple Streaming	
Frame Rate	1080p(1920x1080)@30 fps/ 3M(2048x1536)@15 fps	720P(1280x720) @ 30fps
Resolution	2048x1536(QXGA), 1080P(1920x1080),SXGA(1280x960), 720P(1280x720), 800x600(SVGA), D1(720x480), 4CIF(704x480),VGA(640x480), CIF(352x240)	720P(1280x720), 800x600(SVGA), D1(720x480), VGA(640x480), CIF(352x240)
Network Protocols	IPv4, HTTP/HTTPS, TCP, RTSP/RTCP/RTP, ICMP, UDP, IGMP, DNS, DHCP, ARP, NTP, SNMP	
Slow Shutter	Yes	
WDR	Digital WDR	
Back Light Compensation	Off / On (6 Area Selectable)	
Audio Format	G711-Alaw / G711-Ulaw	
Privacy Zone	Yes	
Motion Detection	Yes	
Security Access	Multiple user access levels with password protection	
Users	1 Administrator, 5 Viewers	

Applications	SDK 2.0
ONVIF	PASS ONVIF Compliance tool V12.06
Web Browsing Requirements	Microsoft Internet Explorer 8.0 or above
Mechanism	
Dimensions	Ø125mm x 106mm(H)
Weight	500g
Connectors	Network: RJ-45 connector Power Input: removable terminal block Audio In/Out: removable terminal block Alarm in/out: removable terminal block
Power Supply	
Power Requirement	PoE IEEE 802.3af class 0, DC 12V, AC 24V
Power Consumption	7W
Environment	
Operating Temperature	-10°C to 40°C
Operating Humidity	90%, non-condensing
Storage Temperature	-20°C to 60°C
Storage Humidity	90%, non-condensing
Safety Regulation	
FCC	Class A
CE Regulation	Class A

Note: Product specifications and pictures are subject to change without notice.