

Earthworks® PIANOMIC™ SYSTEM

USER'S MANUAL PM40T

The Ultimate Piano Microphone System
That Will Change Piano Miking Forever

TOURING
Piano Microphone System

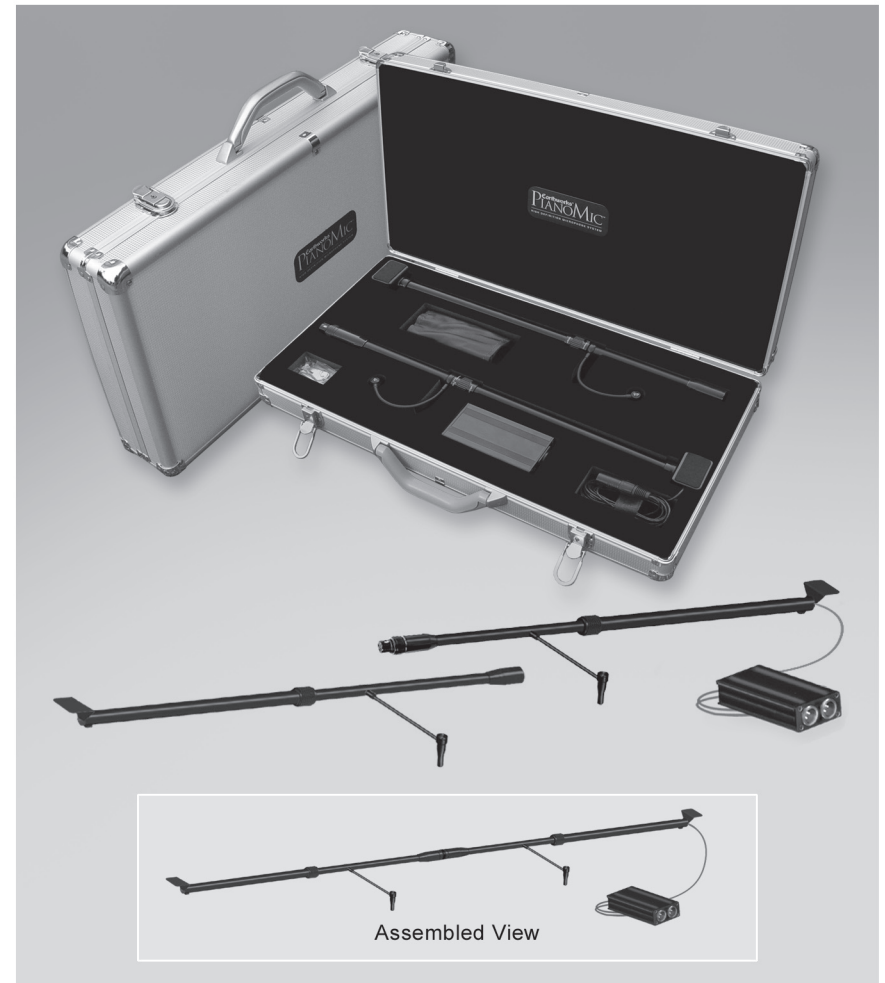

Earthworks®
HIGH DEFINITION MICROPHONES™

Printed in U.S.A.

Earthworks®
HIGH DEFINITION MICROPHONES™

Custom Made in the U.S.A.

Notes:

Congratulations on your purchase of the innovative Earthworks Touring PianoMic™ System. We know that you will be thrilled with the results you will achieve using the Touring PianoMic™ System for both live performance and recording.

Items Enclosed with your New Earthworks Touring PianoMic™ System:

PianoMic™ System Model PM40-T

- 2 – PianoMic™ telescoping bars with attached microphone heads
- 1 – Microphone electronics box
- 1 – Leather pouch for electronics box
- 2 – Felt pads with adhesive backing
- 1 – User's Manual for PianoMic™ System
- 1 – Carrying case
- 1 – Earthworks Full Line Catalog with Demo CD

EVEN IF YOU DON'T LIKE READING MANUALS PLEASE READ THIS SECTION BEFORE INSTALLING THE PIANOMIC™ SYSTEM

USING THE PIANOMIC™ SYSTEM

The majority of those who purchase the PianoMic™ System have experience in miking pianos with conventional microphones, and may find the close-miking techniques described in this Manual to be unconventional. Please keep in mind that the PianoMic™ System utilizes a number of new technologies and that the PianoMic™ microphones work and perform much differently than conventional microphones. The typical practices for piano miking using conventional microphones will most likely not apply when using the PianoMic™ System. With the PianoMic™ System the rules for miking pianos have changed.

Conventional miking practices suggest that a piano must be miked from outside to achieve a good sound, and that a good piano sound cannot be achieved with closely placed microphones inside the piano, especially with the lid closed. When you listen to the incredible results achieved using the PianoMic™ System (at full-stick, half-stick or lid closed), you will realize how unique and groundbreaking it actually is. As the PianoMic™ System changes many of the conventional rules and methods of miking pianos; we strongly suggest that you start by following our guidelines first. Afterwards, if you want to experiment, you can take it from there.

The Earthworks PianoMic™ System incorporates a number of proprietary technologies that allow this method of close-miking pianos to achieve results that have previously not been possible. This improved performance has been accomplished by using specially designed High Definition Microphones created specifically to work inside a piano. These are carefully matched Random Incidence omni microphones with extremely fast impulse response, very short diaphragm settling time, extended frequency response (4Hz to 40kHz), near perfect polar response, high current Class A amplifiers and the ability to handle sound pressure levels up to 148dB SPL.

ASSEMBLING & DISASSEMBLING THE TOURING PIANOMIC™

The PianoMic™ System is quick and easy to install. Once you have initially set up the PianoMic™ System you will be able to do it from that point on in just a few minutes. Here are some helpful guidelines:

CAUTION – the microphone heads and goosenecks are permanently attached to the two PianoMic™ telescoping tubes and cannot be moved, or removed. Once assembled, the distance between the two goosenecks is fixed at 16 inches (one-third of the width of a piano keyboard).

Check that all items are included with your Touring PianoMic™ System by using the list of “Items Enclosed” on page one of this manual.

TO ASSEMBLE

1. Remove the two PianoMic™ telescoping bars from the case. Notice that on each of the two telescoping bars, there is a special XLR type connector. There is a rotating collar next to the special XLR type connector on the telescoping bar that has a cable coming out of one end, (see Section B in Fig 1-A).

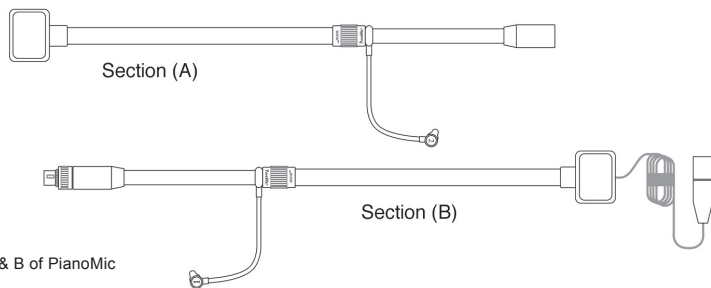

Figure 1-A
Sections A & B of PianoMic

2. Rotate the collar on the XLR connector so it is snug against the connector cover, but not too tight. (Fig. 1-B)

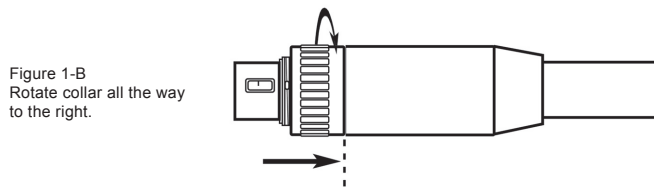

Figure 1-B
Rotate collar all the way to the right.

3. Next, rotate the collar two turns in the opposite direction (moving it away from the connector cover toward the connector pins). (Fig. 1-C)

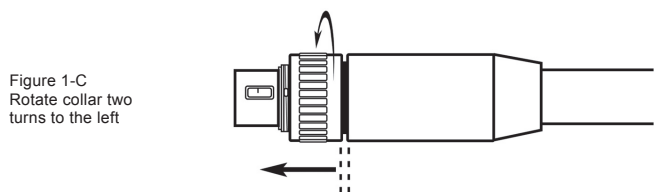
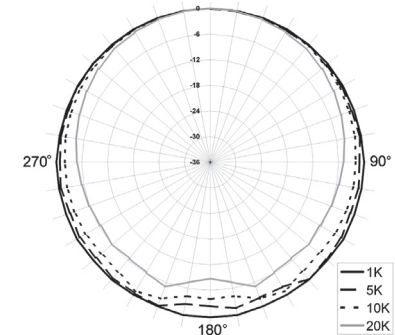

Figure 1-C
Rotate collar two turns to the left

WARRANTY

All Earthworks products carry a two-year limited warranty (parts and labor). If you have any problems with your Earthworks products, please contact our warranty/repair department by email at: returns@earthworksaudio.com or by telephone at (603) 654-6427, Ext. 20.



PianoMic™ Polar Response

PM40T Specifications

Frequency Response:	4Hz - 40kHz
Polar Pattern:	Omnidirectional (random incidence)
Sensitivity:	15mV/Pa (-36 dBV/Pa)
Power requirements:	48V Phantom, 10mA
Peak Acoustic Output:	148 dB SPL
Output:	XLR-3 (pin 2+)
Min. Output Load:	600 ohms (pins 2 & 3)
Noise:	22dBA
Mic Gooseneck Length:	4.875" (12cm)
Rod Length Assembled:	64"(160cm) fully extended 46"(115cm) fully collapsed
Rod Length Separated:	23"(58.4cm) fully collapsed
Carrying Case :	24.5"x12.5"x4" (619x317x100 cm)
Product Weight:	6 lbs. (2.7 kg)
Shipping Dimensions:	26"x18"x8" (66x46x20 cm)
Shipping Weight:	13 lbs. (6 kg)



Earthworks, Inc.
37 Wilton Rd.
Milford, NH 03055
603-654-6427, ext. 14
www.earthworksaudio.com
Made in U.S.A.

Now you should be ready to use the PianoMic™ System and achieve some impressive sonic results for recording or live performances.

If you have any questions after reading and following the directions in this manual, please contact Earthworks directly using the contact information on page 11 of this manual.

Earthworks: the New Science in Microphones

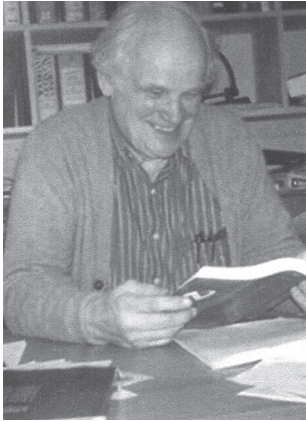

David Blackmer, the brilliant engineer who invented the technologies of dbx, is also the inventor and founder of Earthworks. In the last few years of his life, David developed a number of revolutionary technologies that dramatically improve the quality and performance of microphones. In short, Earthworks High Definition Microphones™ will pick up sounds and details that other microphones cannot. These dramatic improvements are in the areas of impulse response, diaphragm settling time and improved polar pattern technologies. Those who have heard Earthworks High Definition Microphones™ say

that they hear more attack, more subtle detail and a more pristine quality in the sound than with any other microphones regardless of price. Since David's death in 2002 the Earthworks engineers have continued to develop new innovations in microphone design such as the PianoMic™ System, FlexWand™ and High Definition Drum Microphones.

4. Now, take the two PianoMic telescoping sections and mate the connectors just like you would mate a standard XLR connector (see Fig. 1-D). First mate the keyways and then push the connectors together until you hear a “click.” If you do not hear a click, then change the position of the rotating collar and try to mate the two sections again.

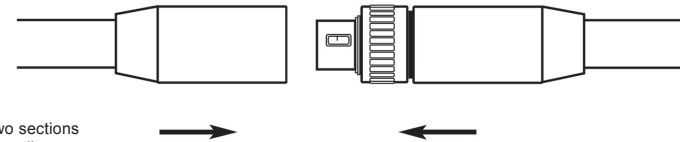

Figure 1-D
Mate the two sections by pushing until you hear a click.

5. Once you have heard the click when mating the two sections, rotate the collar until it is firmly positioned against the mating connector cover (finger tight). At this point two sections should be firmly attached and will not be loose or wiggle. (Fig. 1-E)

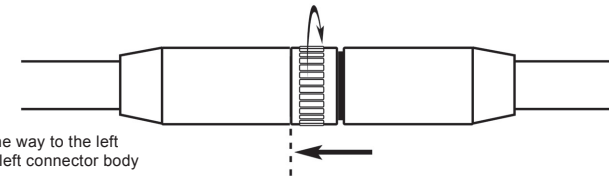

Figure 1-E
Rotate collar all the way to the left firmly against the left connector body

TO DISASSEMBLE

7. To disassemble the PianoMic, rotate the collar between the XLR connectors the full distance from its mating half until it is snugly against the right connector body as shown in Fig. 1-F.

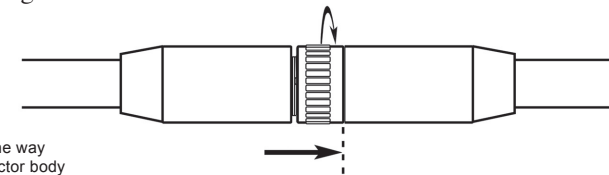

Figure 1-F
Rotate collar all the way to the right connector body

8. Then grab the two mating connectors (one with each hand) and pull the two sections apart as shown in Fig. 1-G. *Do not pull apart holding onto the telescoping tubes.*

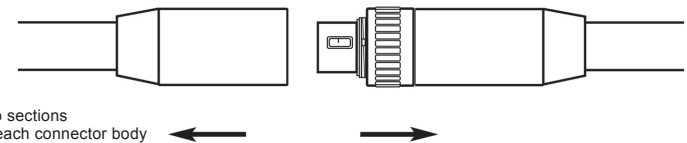

Figure 1-G
Separate the two sections by holding onto each connector body

9. Collapse the telescoping bars and place them in the carrying case along with the electronics box and leather pouch. Now you're ready to take your PianoMic™ to the next gig.

The PianoMic™ System provides the following benefits:

- Excellent overall piano sound with uniform level from all strings
- Superb sound with the piano lid up or down
- Tremendous gain before feedback
- Minimal leakage from other instruments surrounding the piano (with piano lid closed)
- Microphones are not visible from outside the piano

People are astonished when they hear the exceptional sound quality of the PianoMic™ System with the piano lid closed. Conventional microphones perform poorly in a piano as the sound inside the piano is coming from every direction and from multiple sound sources. Every string is a sound source. The soundboard is a large and complex sound source. In addition, sounds are reflected off the piano sides, the soundboard and the piano lid multiple times with little attenuation. Sounds inside a piano are randomly arriving from every possible direction at similar levels, all at the same time. This is a classic example of a “diffuse sound field” which is defined as a confined area where there are multiple sound sources and multiple reflections arriving at the microphone from every angle at similar levels simultaneously. A microphone that is placed in such a diffuse sound field has to pick up all of the sound with a proper tonal balance. For optimum results, this task requires a High Definition Random-Incidence Microphone.



Figure 2. Conventional “Free Field” Microphones inside a piano only pick up sound accurately in front of the microphone

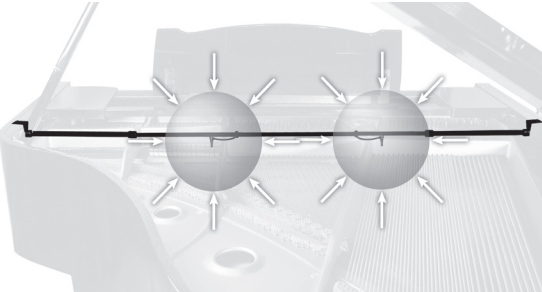
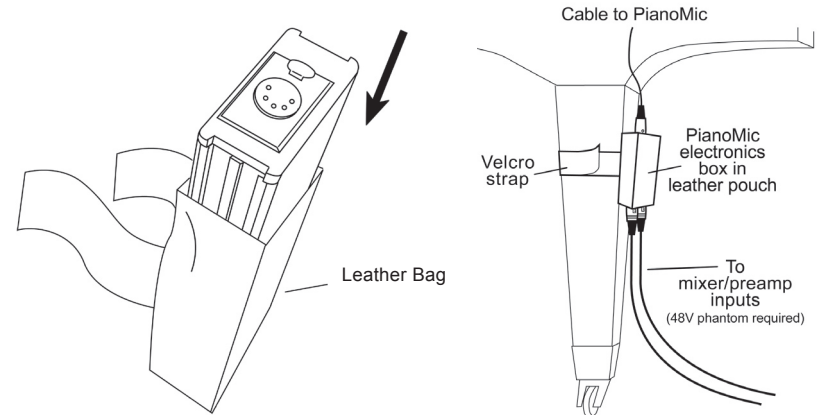

Figure 3. Random Incidence Microphones inside a piano pick up sound accurately from all directions

Conventional microphones are “Free Field” microphones, and regardless of their pickup pattern are designed to only pick up sounds accurately in front of the microphone (See Figure 2).

Random-incidence microphones are designed to uniformly pick up sounds arriving simultaneously from all angles and directions, rather than to the sound coming only from a primary source that is in front of the microphone. Random-incidence microphones have exceptional accuracy and tonal balance in a diffuse sound field, where sound arrives from all directions randomly and simultaneously (See Figure 3).



Figures 15. Placing the Electronics Box in the Pouch.

Figures 16. Attaching the Pouch to the Piano Leg.

Leather Pouch Attached to Piano Leg

The enclosed leather pouch has Velcro straps that allow it to be attached to the leg of a piano. The pouch is open at the top and the bottom has a strap to prevent the electronics box from falling out of the bottom. There is an opening at the bottom of the pouch to conveniently attach the two standard XLR-3 microphone cables that go to your mixer preamp inputs (See Figures 15 and 16).

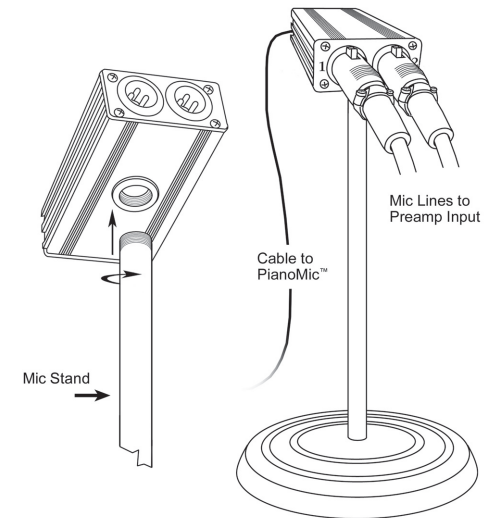

Figure 17. Mounting Electronics Box on a Microphone Stand

Electronics Box Attached to Mic Stand Bracket

The electronics box has a threaded insert in the bottom of the box that will mate with the threads on a standard microphone stand. By this method, the electronics box can be mounted to a short mic stand to keep it above floor level, if desired (see Figure 17).

11. With the PianoMic™ placed inside the piano and the microphones properly positioned you are ready to connect the PianoMic™ cable to the electronics box via a 5-pin XLR connector. The back of the electronics box has two XLR-3 connectors that will connect the microphone outputs to the preamp inputs of your mixer (See Figure 13).

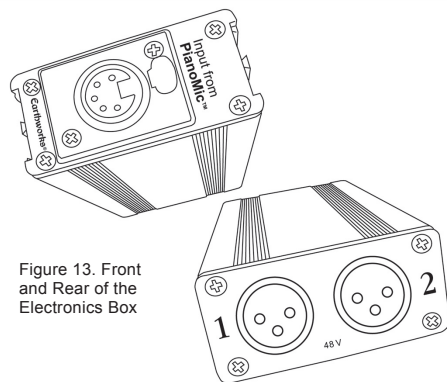

Figure 13. Front and Rear of the Electronics Box

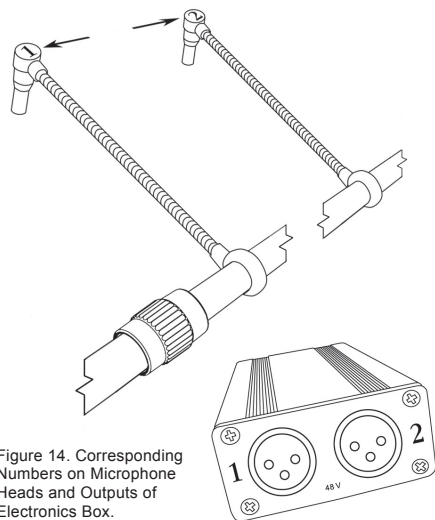

Figure 14. Corresponding Numbers on Microphone Heads and Outputs of Electronics Box.

12. Notice in Figure 14 that the top of each microphone head has a number. These numbers correspond to the numbers on the rear of the electronics box. Depending upon how the PianoMic™ is placed in the piano the high strings will be indicated by either the number 1 or number 2. Once the PianoMic™ has been placed, identify the microphone numbers on the mic heads for both the high and low strings and remember that they correspond to the numbers on the rear of the

electronics box. This will allow you to correctly identify the microphone signals for high and low strings that are connected to the preamps of your mixer. Remember that the PianoMic™ requires 48-volt phantom power.

13. There are two ways to mount the electronics box: (1) in a leather pouch strapped to the leg of the piano, or (2) attached to a short microphone stand. The PianoMic™ System comes equipped to install the electronics box in either of these two ways.

Any recording or live sound engineer will tell you that conventional microphones do a poor job inside a piano with the lid closed. Sound engineers were amazed when they heard the exceptional sound quality of the PianoMic™ System used inside a piano with the lid open and at half-stick. But they were absolutely floored upon hearing the fantastic performance with the lid closed.

When using a PianoMic™ System for live performance you will achieve the most gain before feedback with the piano lid fully closed. You will also have the least amount of leakage from sounds outside the piano with the piano lid closed.

We know you will be more than pleased with the performance of the PianoMic™ System for both recording and live sound applications.

SETTING UP THE PIANOMIC

1. With the PianoMic™ assembled, loosen the two clutches on either side of the two microphone goosenecks (See Figure 4). *When adjusting the clutches, be sure to hold the larger diameter tube section with one hand while rotating the clutch with the other hand as indicated in figure 4.* However, do not loosen the clutches all the way; just enough so the bar can be extended and still have a little friction. This will make it easier to adjust the length of the bar from both ends once it is placed inside the piano.

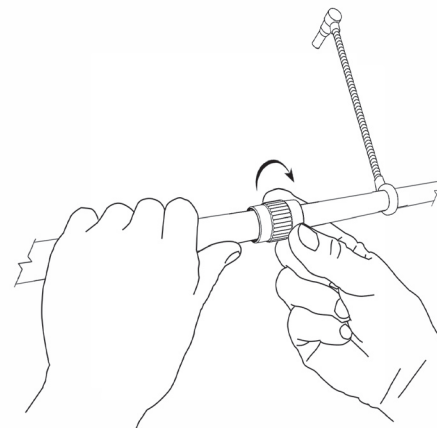

Figure 4. Loosening the Clutches

2. Extend both sides of the bar so that it is wider than the piano.

3. Notice that on each end of the PianoMic™ bar there are support brackets that will be placed on the upper edge of the piano case sides. These support brackets have rounded edges and are covered with a soft polyolefin coating to avoid scratching the piano. The support brackets are thin enough to allow the piano lid to be completely closed with the PianoMic™ System inside the piano. The PianoMic comes with felt pads installed on the top of each support arm. If you desire a more snug fit with the lid closed or if vibration becomes an issue, install one of the enclosed spare felt pads on the bottom side of the support brackets as shown in Figure 5.

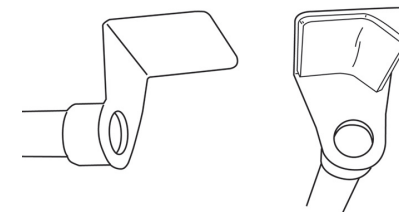

Figure 5. Support Arms and Installing Felt Pads

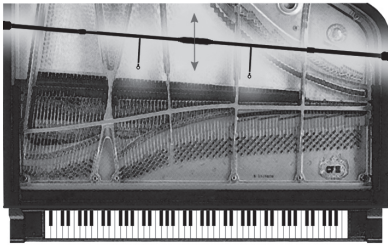

Figure 6. Facing the Mic Heads Towards the Dampers

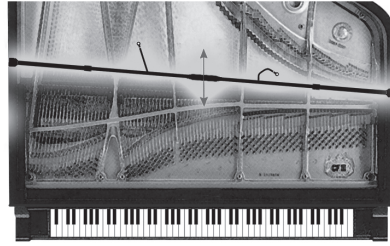
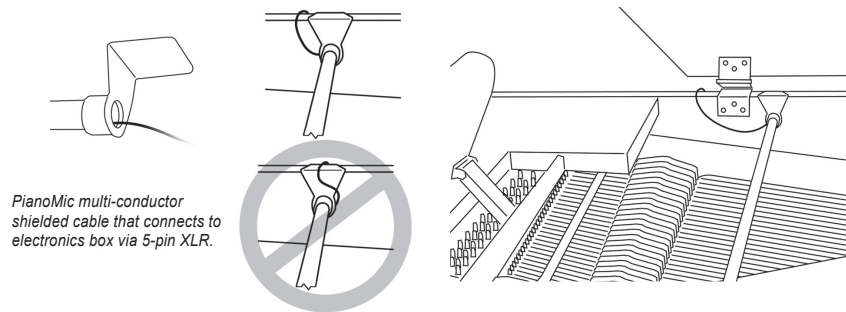

Figure 7. Facing the Mic Heads Away From the Dampers

4. The PianoMic™ can be placed inside the piano with the microphone heads either facing the dampers (*Figure 6*) or facing away from the dampers (*Figure 7*). For optimum results, the PianoMic™ System should be placed in the piano with the microphone heads positioned two to three inches away from the dampers. How you place the PianoMic™ System in the piano will depend upon the piano, its size and how it is made. This will govern whether the microphone heads can be faced toward or faced away from the dampers. It is best to position the PianoMic™ System so that the support bracket does not rest on the curved part of the piano case.



PianoMic multi-conductor shielded cable that connects to electronics box via 5-pin XLR.

Figure 8. Positioning the PianoMic Cable

5. Notice that one end of the PianoMic™ has a multi-connector shielded cable coming out of the tube below the support arm (*Figure 8*). It doesn't matter which side of the piano the cable exits. The main objective is to place the PianoMic™ in the piano so that the microphone heads can be easily placed 2 to 3 inches in front of the dampers. The cable is long enough to easily reach the opposite side of the piano should you decide to locate the electronics box on the opposite side of the piano from where the cable comes out of the PianoMic™. You will need to position the cable so it does not lie on top of the support arm. The combined thickness of the support arm with the cable on top if it would exceed the size of the opening between the piano case and the lid. Therefore when the lid is closed it would pinch and deform the cable. To avoid this, place the cable to one side of the support arm. You may also position the cable so it comes out the open area of the piano as illustrated in *Figure 8*.

6. Once you have determined which placement will provide you with the ability to have the microphone heads two to three inches in front of the dampers, you are ready to place the PianoMic™ System inside the piano. With the bar fully extended and the clutch adjusted where there is still a little friction, place the support bracket on the edge of the piano case opposite you. Then push on the bar until the PianoMic™ is the correct length to allow the support bracket to easily rest on the edge of the piano case nearest to you.

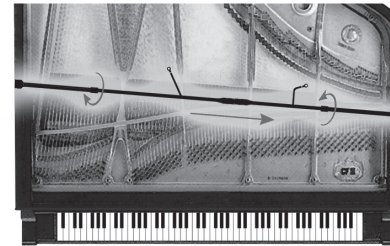

Figure 9. Favoring the High Strings

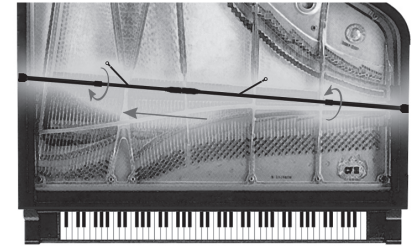

Figure 10. Favoring the Low Strings

7. With the PianoMic™ in place, you will need to determine if you want the microphones to favor the high strings, low strings or neither. The center section of the PianoMic™ can slide up to eight inches in either direction in order to favor the high or low strings, if desired. This positioning is illustrated in *Figures 9* and *10*.

8. Once you have positioned the PianoMic™ center section, tighten both clutches to insure that the PianoMic™ bar stays in place.

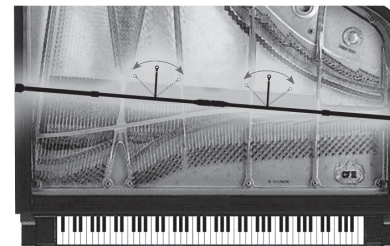

Figure 11. Adjustable flex arms for the Microphones

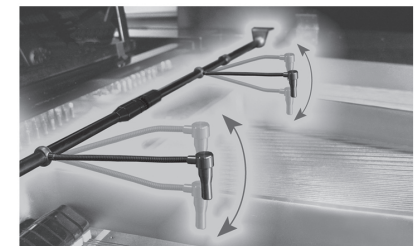

Figure 12. Adjusting the Microphone Height

9. With the PianoMic™ in place, you can move the flex arms attached to the microphone heads several inches to the left or to the right to achieve your desired placement (*See Figure 11*).

10. The flex arms also allow you to adjust the height of the microphone heads as shown in *Figure 12*. It is suggested that you place the microphone heads two to three inches above the piano strings.