

Always there to help you

Register your product and get support at
www.philips.com/welcome



GoGEAR

SA4VBE04

SA4VBE08

SA4VBE16



User manual

PHILIPS

Contents

1 Important safety information 3

- General maintenance 3
- Environmental information 5
- Recycling the product 6

2 Your new player 7

- What's in the box 7
 - PC software loaded on the player 7
 - Files loaded on the player 7
- Overview 8
 - Controls 8
 - Home screen 8
 - Lock/unlock the keys 9
 - SafeSound 9

3 Get started 10

- Charge power 10
- Switch the player on or off 10
 - Automatic standby and shut-down 10

4 Music 11

- Transfer music to the player 11
- Find music on the player 11
 - Find music by song information 11
 - Find music by playlist 11
 - Find music by file folder 11
 - Superscroll 11
- Play music 12
 - Play from the same collection 12
 - Select play options 12
- Playlists 12
 - Add songs to a playlist-on-the-go 12
 - Remove songs from a playlist-on-the-go 13
- Delete songs from the player 13

5 Audiobooks 14

- Sync audio books to the player 14
 - Install AudibleManager on the PC 14
 - Download audiobooks to the PC 14
 - Sync to the player 14

- Find audiobooks on the player 15
- Play audiobooks 15
- Use bookmarks 15
- Delete audiobooks from the player 15

6 Videos 16

- Transfer videos to the player 16
 - Install Philips Media Converter 16
 - Use Philips Media Converter 16
- Find videos on the player 17
- Play videos 17
- Delete videos from the player 17

7 Pictures 18

- Add pictures to the player 18
- Find pictures on the player 18
- View pictures 18
 - Start a slideshow 18
 - Select play options 18
- Delete pictures from the player 18

8 Folder view 19

9 Settings 20

- Play mode 20
- Sound settings 20
 - SafeSound 20
- Sleep timer 20
- Display settings 21
 - Screensaver 21
- Slideshow settings 21
- Language 21
- PC connection preference 21
- Information 21
- Format device 22
- Factory settings 22
- CD installer 22

10 Sync with PC music library through Philips Songbird 23

- Install Philips Songbird 23
- Collect music files from the PC 23
 - Set the watch folder 23
 - Import media files 24

Get contents from online sources	25
Search online	25
Create playlists in Philips Songbird	25
Create a playlist	25
Generate LikeMusic playlists	26
Save the play queue as a playlist	27
Play a playlist	28
Manage media files in Philips Songbird	28
Edit metadata	28
Get album artwork	28
Remove media files from the library	29
Sync the player with Philips Songbird	29
Select auto or manual sync	29
Auto sync	30
Manual sync	30

11 Update the firmware through Philips Songbird

31

12 Repair the player through Philips Songbird

32

13 Technical data

33

PC requirements 33

Need help?

Please visit

www.philips.com/welcome

where you can access a full set of supporting materials such as the user manual, the latest software updates, and answers to frequently asked questions.

1 Important safety information

General maintenance

The translation of this document is for reference only.

In the event of any inconsistency between the English version and the translated version, the English version shall prevail.

! Caution

- To avoid damage or malfunction:
- Do not expose the product to excessive heat caused by heating equipment or direct sunlight.
- Do not drop the product or allow objects to fall on your player:
- Do not allow the product to be submerged in water: Do not expose headphone socket or battery compartment to water; as water entering the set may cause major damage.
- Active mobile phones in the vicinity may cause interference.
- Back up your files. Ensure that you retain the original files you have downloaded to your device. Philips is not responsible for any loss of data if the product becomes damaged or not readable / legible.
- Manage (transfer, delete, etc.) your music files only with the supplied music software to avoid problems.
- Do not use any cleaning agents containing alcohol, ammonia, benzene, or abrasives as these may harm the product.
- Batteries (battery pack or batteries installed) shall not be exposed to excessive heat such as sunshine, fire or the like.
- Danger of explosion if battery is incorrectly replaced. Replace only with the same or equivalent type.

About operating and storage temperatures

- Operate in a place where temperature is always between 0 and 35°C (32 to 95°F)
- Store in a place where temperature is always between -20 and 45°C (-4 to 113°F).

- Battery life may be shortened in low temperature conditions.

Replacement parts/accessories:

Visit www.philips.com/support to order replacement parts/accessories.

Hearing Safety



A pleine puissance, l'écoute prolongée du baladeur peut endommager l'oreille de l'utilisateur.



Go ahead?

The maximum output voltage of the player is not greater than 150 mV.

Modifications

Modifications not authorized by the manufacturer may void user's authority to operate the product.

Copyright information

All other brands and product names are trademarks of their respective companies or organizations.

Unauthorized duplication of any recordings whether downloaded from the Internet or made from audio CDs is a violation of copyright laws and international treaties.

The making of unauthorized copies of copy-protected material, including computer programs, files, broadcasts and sound recordings, may be an infringement of copyrights and constitute a criminal offense. This equipment should not be used for such purposes.

The Windows Media and the Windows logo are registered trademarks of Microsoft Corporation in the United States and/or other countries.

Be responsible! Respect copyrights.



Be responsible Respect copyrights

Philips respects the intellectual property of others, and we ask our users to do the same. Multimedia content on the internet may have been created and/or distributed without the original copyright owner's authorization. Copying or distributing unauthorized content may violate copyright laws in various countries including yours.

Compliance with copyright laws remains your responsibility.

The recording and transfer to the portable player of video streams downloaded to your computer is intended only for use with public domain or properly licensed content. You may only use such content for your private, non-commercial use and shall respect eventual copyright instructions provided by the copyright owner of the work. Such instruction may state that no further copies shall be made. Video streams may include copy protection technology that prohibits further copying. For such situations the recording function will not work and you will be notified with a message.

Data logging

Philips is committed to improving the quality of your product and enhancing the Philips user experience. To understand the usage profile of this device, this device logs some info / data to the non-volatile memory region of the device. These data are used to identify and detect any failures or problems you as a user may experience while using the device. The data stored, for example, will be the duration of playback in music mode, duration of playback in turner mode, how many times battery low was encountered, etc. The data stored do not reveal the content or media used on the device or the source of downloads. The data stored on the device are retrieved and used ONLY if the

user returns the device to the Philips service center and ONLY to simplify error detection and prevention. The data stored shall be made available to user on user's first request.

Monkey's Audio decoder

- ① The Monkey's Audio SDK and source code can be freely used to add APE format playback, encoding, or tagging support to any product, free or commercial. Use of the code for proprietary efforts that don't support the official APE format require written consent of the author.
- ② Monkey's Audio source can be included in GPL and open-source software, although Monkey's Audio itself will not be subjected to external licensing requirements or other viral source restrictions.
- ③ Code changes and improvements must be contributed back to the Monkey's Audio project free from restrictions or royalties, unless exempted by express written consent of the author.
- ④ Any source code, ideas, or libraries used must be plainly acknowledged in the software using the code.
- ⑤ Although the software has been tested thoroughly, the author is in no way responsible for damages due to bugs or misuse.

If you do not completely agree with all of the previous stipulations, you must cease using this source code and remove it from your storage device.

FLAC decoder

Copyright (C) 2000,2001,2002,2003,2004,2005, 2006,2007,2008,2009 Josh Coalson

Redistribution and use in source and binary forms, with or without modification, are

permitted provided that the following conditions are met:

- Redistributions of source code must retain the above copyright notice, this list of conditions and the following disclaimer.
- Redistributions in binary form must reproduce the above copyright notice, this list of conditions and the following disclaimer in the documentation and/or other materials provided with the distribution.
- Neither the name of the Xiph.org Foundation nor the names of its contributors may be used to endorse or promote products derived from this software without specific prior written permission.

THIS SOFTWARE IS PROVIDED BY THE COPYRIGHT HOLDERS AND CONTRIBUTORS "AS IS" AND ANY EXPRESS OR IMPLIED WARRANTIES, INCLUDING, BUT NOT LIMITED TO, THE IMPLIED WARRANTIES OF MERCHANTABILITY AND FITNESS FOR A PARTICULAR PURPOSE ARE DISCLAIMED. IN NO EVENT SHALL THE FOUNDATION OR CONTRIBUTORS BE LIABLE FOR ANY DIRECT, INDIRECT, INCIDENTAL, SPECIAL, EXEMPLARY, OR CONSEQUENTIAL DAMAGES (INCLUDING, BUT NOT LIMITED TO, PROCUREMENT OF SUBSTITUTE GOODS OR SERVICES; LOSS OF USE, DATA, OR PROFITS; OR BUSINESS INTERRUPTION) HOWEVER CAUSED AND ON ANY THEORY OF LIABILITY, WHETHER IN CONTRACT, STRICT LIABILITY, OR TORT (INCLUDING NEGLIGENCE OR OTHERWISE) ARISING IN ANY WAY OUT OF THE USE OF THIS SOFTWARE, EVEN IF ADVISED OF THE POSSIBILITY OF SUCH DAMAGE.

XPAT XML Parser

Copyright (c) 1998, 1999, 2000 Thai Open Source Software Center Ltd

Permission is hereby granted, free of charge, to any person obtaining a copy of this software and associated documentation files (the "Software"), to deal in the Software without restriction, including without limitation the rights to use, copy, modify, merge, publish, distribute, sub-license, and/or sell copies of the Software, and to permit persons to whom the Software is furnished to do so, subject to the following conditions:

The above copyright notice and this permission notice shall be included in all copies or substantial portions of the Software. THE SOFTWARE IS PROVIDED "AS IS", WITHOUT WARRANTY OF ANY KIND, EXPRESS OR IMPLIED, INCLUDING BUT NOT LIMITED TO THE WARRANTIES OF MERCHANTABILITY, FITNESS FOR A PARTICULAR PURPOSE AND NON-INFRINGEMENT. IN NO EVENT SHALL THE AUTHORS OR COPYRIGHT HOLDERS BE LIABLE FOR ANY CLAIM, DAMAGES OR OTHER LIABILITY, WHETHER IN AN ACTION OF CONTRACT, TORT OR OTHERWISE, ARISING FROM, OUT OF OR IN CONNECTION WITH THE SOFTWARE OR THE USE OR OTHER DEALINGS IN THE SOFTWARE.

Environmental information

All unnecessary packaging has been omitted. We have tried to make the packaging easy to separate into three materials: cardboard (box), polystyrene foam (buffer) and polyethylene (bags, protective foam sheet.)

Your system consists of materials which can be recycled and reused if disassembled by a specialized company. Please observe the local regulations regarding the disposal of packaging materials, and old equipment.

Recycling the product

Your product is designed and manufactured with high quality materials and components, which can be recycled and reused. When you see the crossed-out wheel bin symbol attached to a product, it means the product is covered by the European Directive 2002/96/EC:



Never dispose of your product with other household waste. Please inform yourself about the local rules on the separate collection of electrical and electronic products. The correct disposal of your old product helps prevent potentially negative consequences on the environment and human health.

Warning

- For products with "non-exchangeable" built-in batteries: The removal of (or the attempt to remove) the battery invalidates the warranty. This procedure is only to be performed at the end of the product's life.

Your product contains a built-in rechargeable battery covered by the European Directive 2006/66/EC, which cannot be disposed of with normal household waste.



To safeguard the functionality and safety of your product, take your product to an official collection point or service center where a professional can remove the battery as shown:

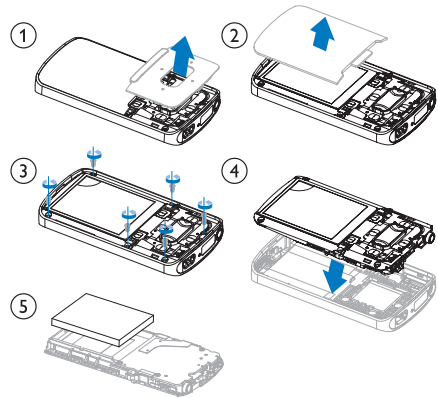

Please inform yourself about the local rules on separate collection of batteries. The correct disposal of batteries helps prevent potentially negative consequences on the environment and human health.

Notice for the European Union

This product complies with the radio interference requirements of the European Union.

2 Your new player

Note

- The images serve as reference only. Philips reserves the right to change color/design without notice.

What's in the box

Make sure that you have received the following items:
Player

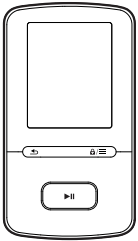

Earphones

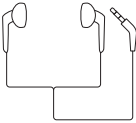

USB cable



Quick start guide



Safety and Warranty sheet



PC software loaded on the player

VIBE comes with the following PC software:

- **Philips Songbird** (helps you update the firmware of the player; and manage your music library on a PC and the player).
- **Philips Media Converter** (helps you convert videos to the file type that is supported on the player; and transfer the converted files to the player).

To get Philips Songbird and Philips Media Converter online,

- On your PC, go to www.philips.com/Songbird or www.philips.com/support.

Files loaded on the player

The following files are loaded on VIBE:

- User manual
- Frequently asked questions

Overview

Controls

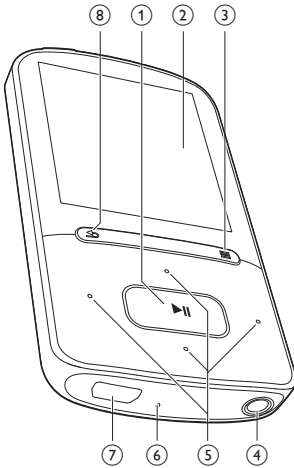

- ①
 - Press and hold: Switch the player on or off
 - Press: Select options, or start/pause/resume play
 - ② **Display**
 - ③ /
 - Press: Show options menu
 - Press and hold: Lock/unlock all buttons
 - ④
 - 3.5-mm headphone connector
 - ⑤ /
 - **on the list of options:**
Press: Skip to the previous/next option
Press and hold: Show the initial of current option in a list of options that are sorted by alphabet
 - **on the play screen:**
Press: Increase/decrease the volume
Press and hold: Increase/decrease the volume quickly
- /
- **on the play screen:**

Press: Skip to the next/previous file
Press and hold: Fast forward or rewind within current file

- ⑥ **RESET**
 - Press the hole by using the tip of a ball pen when the screen does not respond to the pressing of keys
- ⑦
 - USB connector for power charging and data transfer
- ⑧
 - Press: Back one level
 - Press and hold: Return to the Home screen

Home screen

Menu	Mode	To
	Music	play audio files
	Video	watch videos
	Pictures	view pictures
	Folder	view files in folders view
	Settings	customize the settings of VIBE
	Now playing	show current play screen

Navigate from the Home screen

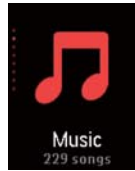

- From the Home screen, you can access functional menus by pressing the navigation buttons / and .
- To go back to previous screens, press repeatedly; or; press and hold to return to the Home screen.

Switch between the Home screen and play screen

On the Home screen,

During music play,

- Press  ;
- Alternatively, press  and select **[Now playing]** or **[Last played]**.

On the play screen,

- Press and hold .



Select a theme

To select a theme for the display,

- On the Home screen, press  and select **[Theme]**.

Lock/unlock the keys





When the player is on, use the lock to prevent accidental operation.

- Press and hold  /  to lock or unlock the keys.
 - ↳ All buttons except the volume keys are locked and a lock icon is displayed.

SafeSound

With the earphones, **SafeSound** allows you to listen to music in a safe way.



When you listen to music through the earphones, the sound pressure on your ears is estimated¹ based on the electrical characteristics of the player and earphones. Then, the estimate is compared against the reference levels² of sound pressure. As a result, icons of different colors can be displayed to indicate status of sound pressure and the levels of risks to hearing damage.

	Level of sound pressure	Maximum duration
	more than 90 decibels	30 minutes a day
	85 to 90 decibels	2 hours a day
	80 to 85 decibels	5 hours a day
	safe	more than 5 hours a day

Tip

- ¹The methodology is based on European norm (50332-1/2).
- ²The reference levels come from the minimum requirement for health and safety that the European directive 2003/10/EC provides for the noises exposed to individuals.

Use the SafeSound

- 1 Make sure that you have plugged the earphones into the player.
- 2 On the music play screen, press  /  .
 - ↳ The volume screen is displayed.
- 3 On the volume screen, press  to select the **SafeSound** options.

Tip

- For the information about SafeSound options, see 'SafeSound' (see 'SafeSound' on page 20).

3 Get started

Charge power

VIBE has a built-in battery that can be charged through the USB socket of a computer. Connect **VIBE** to a PC by using the USB cable.

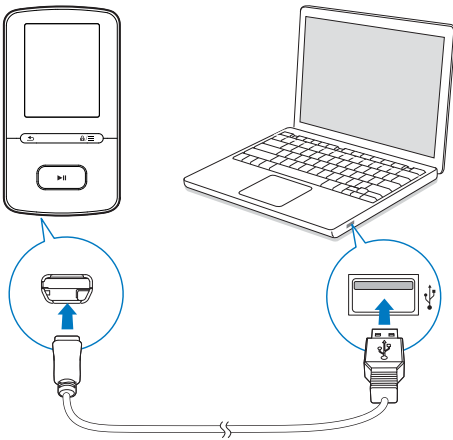

Note

- When you connect **VIBE** to a computer, you are briefly prompted to select: **[Charge & transfer]** or **[Charge & play]**.
- **VIBE** automatically applies **[Charge & transfer]**, if no new selection is made.

Battery level indication

- When the battery is low, the low battery screen is displayed repeatedly.
- When the charging process is complete,  is displayed.

Note

- Rechargeable batteries have a limited number of charge cycles. Battery life and number of charge cycles vary by use and settings.

Switch the player on or off

Press and hold  until the player is switched on or off.

Automatic standby and shut-down

The player has an automatic standby and shut-down feature that can save battery power: After 10 minutes in idle mode (no play, no button is pressed), the player switches off.

4 Music

Transfer music to the player

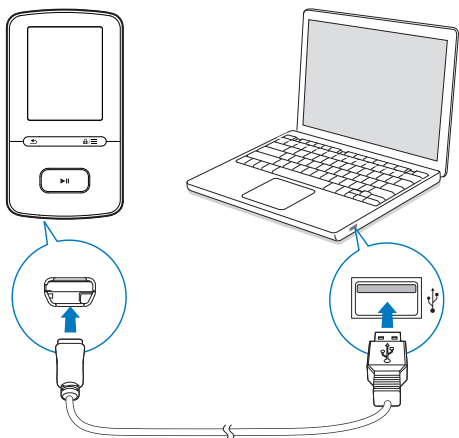

You can transfer music from your PC media library to **VIBE** in the following ways:

- Sync through Philips Songbird (see 'Sync with PC music library through Philips Songbird' on page 23); With the media management software, you can access online music stores, create playlists, or edit your music collection by song information.
- Drag and drop music files in Windows Explorer.
By doing so, you can organize your music collection by file folder.

To drag and drop music files in Windows Explorer,

- 1 Connect **VIBE** to a PC.
- 2 On the PC, under **My Computer** or **Computer**,
 - select **VIBE**, and create file folders.
- 3 On the PC, drag and drop music files to the file folders on **VIBE**.
 - Alternatively, drag and drop file folders from the PC to **VIBE**.

Find music on the player

On **VIBE**, you can find music by song information, playlist, or file folder. With **Superscroll**, you can quickly browse through the music library by initial.

Find music by song information

In **♪**, songs are sorted by metadata or ID3 tag under different collections: **[All songs]**, **[Artists]**, **[Albums]**, or **[Genres]**.

[All songs]

- Songs are sorted by song title in alphabetical order.

[Artists]

- Songs are sorted by artist in alphabetical order;
- Under each artist, songs are sorted by album in alphabetical order.

[Albums]

- Songs are sorted by album in alphabetical order.

[Genres]

- Songs are sorted by genre, such as pop, rock.

Find music by playlist



In **♪** > **[Playlists]**, find the playlist that you transfer from the PC media library.

Find music by file folder

In **■**, find music by file folder.

Superscroll

In a list of options that are sorted by alphabet, **Superscroll** allows you to browse the options by initial.

- Press and hold  /  to start **Superscroll**.
 - ↳ On the screen, you can see the initials of current options.



Play music

You can start play from a song, or play an entire album or artist.



To start play from a song,

- 1 Select a song.
- 2 Press  to start play.
 - ↳ Play starts from current song.

To play the entire album or artist,

- 1 Select an album or artist.
- 2 Press  > **[Play all]**.
- 3 Press  to start play.

On the play screen,

- Press  to pause and resume play.
- To go to the previous screen, press .
 - ↳ The play screen returns a few seconds later.
 - ↳ On the play screen, you can see the file information and play status.



To adjust the volume,

- On the play screen, press  / .

To select a music file on the play screen,



- Repeatedly press  / .

To rewind or fast forward within current song,



- On the play screen, press and hold  / .

Play from the same collection

During the song play, you can switch to a collection the same as that of current song.

- 1 On the play screen, press  and select **[Play mode]**.
- 2 In **[Play music from...]**, select **[... this artist]**, **[... this album]**, or **[... this genre]**. Press .
 - ↳ You start to play current artist, album, or genre.

To play all the songs on the player,

- 1 On the play screen, press  and select **[Play mode]**.
- 2 In **[Play music from...]**, select **[All songs]**. Press .

Select play options

On the play screen, press  to select play options, such as play mode, sound settings, and sleep timer (see 'Settings' on page 20).



Playlists

On the players, you can find the following playlists:



- playlists that you transfer from the PC media library;
- three playlists-on-the-go for you to add songs on the player.

Add songs to a playlist-on-the-go

To add current song,



- 1 Select or play a song.
- 2 On the list of songs or play screen,
 - press  and select **[Add to playlist]**.
- 3 Select a playlist-on-the-go. Press .
 - ↳ You save current song to the playlist.

To add an album or artist,



- 1 Select an album or artist.
- 2 On the list of albums or artists,
 - press  and select **[Add to playlist]**.
- 3 Select a playlist-on-the-go. Press .
 - ↳ You save the album or artist to the playlist.

Remove songs from a playlist-on-the-go

Remove current song from a playlist

- 1 On the play screen, press  > [Remove from Playlist].
- 2 Select a playlist-on-the-go. Press .
↳ You remove current song from the selected playlist.

Remove all the songs in a playlist

- 1 Go to a playlist-on-the-go.
- 2 In the list of options, press  and select [Clear playlist].
- 3 Press .
↳ You remove all the songs from current playlist.

Delete songs from the player

To delete current song during play,

- On the play screen, press  and select [Delete].
↳ Current song is deleted from the player.

To check the audio books transferred to the player,

See the player pane on **AudibleManager**.

- If necessary, click **Refresh Device**.

Find audiobooks on the player

In **J** > **[Audiobooks]**, audiobook files are organized by book title or author:

[Books]

- Books are sorted by book title in alphabetical order.

[Authors]

- Books are sorted by author in alphabetical order.

Play audiobooks

1 Select a book.

2 Press **▶||** to start play.

- ↳ On the play screen, you can see the book information and play status.

On the play screen,

- Press **▶||** to pause and resume play.
- To go to the previous screen, press **↶**.

To skip titles or sections during play,

1 On the play screen, press **≡** > **[Navigation mode]**. Select **[Titles]** or **[Section]**.

2 On the play screen, press **⏮** / **⏭**.

Use bookmarks

On an audiobook, you can add up to 10 bookmarks to the play time. Start play from the bookmarked play time as needed.

To add a bookmark,

1 On the play screen, press **≡** and select **[Bookmarks]** > **[Add bookmark]**.

2 Select a location.

- ↳ Current play time is added to the location in the list of bookmarks.

To play from a bookmarked play time,

- On the play screen, press **≡** and select **[Bookmarks]** > **[Go to bookmark]**. Select an option.
 - ↳ Play starts from the selected play time.

To delete a bookmark,

- On the play screen, press **≡** and select **[Bookmarks]** > **[Delete bookmark]**. Select an option.
 - ↳ You remove the play time from the list of bookmarks.

Delete audiobooks from the player

- On the play screen, press **≡** > **[Delete Audiobook]**.
 - ↳ Current audiobook is deleted from the player.

6 Videos

Transfer videos to the player

You can transfer videos to the player in two ways:

- Transfer through **Philips Media Converter**;
With the video converter software, you can convert videos to the file type that is supported on the player, and transfer the converted files to the player.
- Drag and drop video files (.smv files) in Windows Explorer.
By doing so, you can organize your video collection by file folder.

Install Philips Media Converter

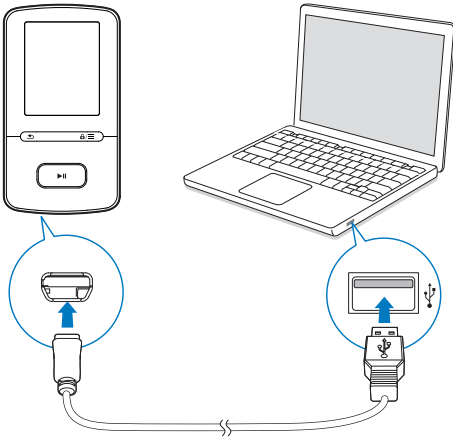

Install Philips Media Converter for the first time

When you connect **VIBE** to a PC for the first time, a pop-up screen is displayed:

- 1 Select your language and country.
- 2 Follow the onscreen instructions to complete the installation.

Note

- The installation requires you to agree to the license terms.

If the pop-up screen is not displayed automatically:

- 1 On the player, make sure that you have selected the following options:
 - In *** > [CD installer]**, select **[Enable]**.
- 2 On the PC, select **My Computer** (Windows XP / Windows 2000) / **Computer** (Windows Vista / Windows 7).
↳ The **Philips Songbird** drive is displayed.
- 3 To install **Philips Media Converter**, double-click **PMCsetup.exe** in the **Philips Songbird** drive.



Note

- The installation requires you to agree to the license terms.

Use Philips Media Converter

- 1 On your PC, launch **Philips Media Converter**.
- 2 Connect the player to the PC by using the USB cable.
 - Wait until the player is recognized by **Philips Media Converter**.



- 3 In **Philips Media Converter**, add videos from your PC library:
 - Click .
 - ↳ The video is added to the list of files for conversion and transfer.
 - To remove a video from the list of files, click .
- 4 In **Philips Media Converter**, start the file conversion and transfer:
 - Click .

↳ Current video is deleted from the player.

Find videos on the player

Find videos by file name

- Go to .
 - ↳ Videos are listed by file name in alphabetical order.

Find videos by file folder

- Go to .
 - ↳ Videos are organized by file folder as on the PC.



Play videos

- 1 Select a video.
- 2 Press  to start play.
 - ↳ The video plays in the landscape view.



On the play screen,

- Press  to pause and resume play.

To select a video file on the play screen,

- Repeatedly press  / .

To rewind or fast forward within current video,

- On the play screen, press and hold  / .

Delete videos from the player

- 1 Select or play a video.
- 2 On the list of videos or play screen,
 - press  and select **[Delete video]**.

7 Pictures

Add pictures to the player

- 1 Connect **VIBE** to a computer.
- 2 On the PC, under **My Computer** or **Computer**,
 - select **VIBE**, and create file folders.
- 3 On the PC, drag and drop files to the file folders on the **VIBE**.
 - Alternatively, drag and drop file folders from the PC to **VIBE**.

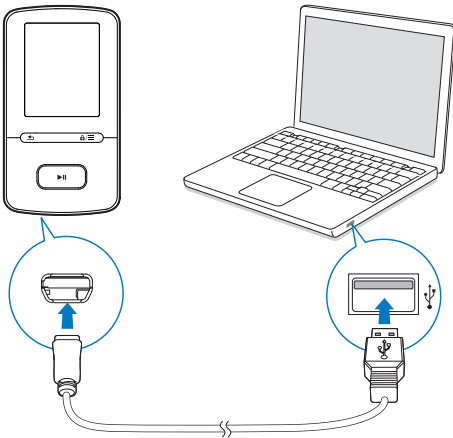

Find pictures on the player

Find pictures by file name

- Go to .
 - ↳ Pictures are listed by file name in alphabetical order.

Find pictures by file folder

- Go to .
- ↳ Pictures are organized by file folder as on the PC.

View pictures

- On the list of pictures, press / and to select a picture.
 - ↳ The picture is displayed in the landscape view.

On the play screen,

- Press / to select a picture.

Start a slideshow

- When you view pictures, press to start a slideshow.
 - ↳ Pictures play one by one.

Select play options

On the play screen, press to select play options:

In **[Slideshow settings]**, select your options for slideshow:

[Time per slide]	Select the time interval between two slides.
[Repeat]	Play pictures in current folder repeatedly.
[Shuffle]	Play pictures in current folder in random order.

Delete pictures from the player

- 1 Select or play a picture.
- 2 On the list of pictures or play screen,
 - press and select **[Delete picture]**.
 - ↳ Current picture is deleted from the player.

8 Folder view

Go to ■ to view and play media files from the media library on the player.

Music: for music files that you sync to the player through **Philips Songbird**;

Video: for video files that you sync to the player through **Philips Songbird**;

Playlists: for playlists that you sync to the player, and the playlists-on-the-go that you create on the player.

SERVICE: for the audiobooks that you sync to the player through **AudibleManager**.

To find files transferred in Windows Explorer,

- Locate the files as you organized in Windows Explorer on the PC.

9 Settings

In *****, select your options for the player:

- 1 Press **⏮** / **⏭** to select an option.
- 2 Press **▶||** to confirm.

Play mode

In **[Play mode]**, select play modes for music play:

[Play music from...]

- Switches to a collection the same as that of current song.

[Repeat]

- **[Repeat 1]:** Repeats current song.
- **[Repeat all]:** Repeats all songs in current folder.

[Shuffle]

- **[On]:** Plays all songs in current folder in random order.

If both **[Repeat all]** and **[Shuffle]** are activated,

- All songs in current folder are repeated in random order.

Sound settings

[FullSound] Restores the sonic details that music compression loses (e.g. MP3, WMA).

[Equalizer] Defines sound settings as desired.



Note

- Equalizer is deactivated when you select **FullSound**.

SafeSound

Select headphone

SafeSound works with compatible earphones.

For accurate measurement, use the by-packed earphones, or the earphones in the list.

In **[Select earphone]**, select the earphones that match yours.

Parental control

Use **[Parental control]** to lock the volume limit that you set for yourself.

Set the password

- 1 Make sure that you have switched on SafeSound (see 'Activate' on page 20).
- 2 In **[Parental control]**, select **[On]**.
- 3 Set the password:
 - ① Press **⏮** / **⏭** repeatedly, or press and hold **⏮** / **⏭** to enter digits.
 - ② Press **⏮** / **⏭** to select the position of entries.
 - ③ Press **▶||** to confirm.

Set the volume limit

In **[Volume limit]**, set a volume limit for yourself.

- 1 Enter the password as needed.
- 2 Press **⏮** / **⏭** to select a volume level.
- 3 Press **▶||** to confirm.

Change the password

In **[Change password]**, enter and set the password as prompted.

Activate

- In **[Activate]**, select **[On]**.
↳ You switch on the **SafeSound** function.

Sleep timer

Switch on the sleep timer. The **VIBE** can switch off automatically after a certain time duration.

- In **[Sleep timer] > [Set sleep timer...]**, select an option. Press **▶||**.
↳ After the selected time duration, the device is switched off automatically.

After the sleep timer is switched on,

- Select ***** > **[Sleep timer]**;

- Alternatively, on the music play screen, press  > **[Sleep timer]**.
↳ You can see the time left before the player is switched off.

Display settings





[Theme]

- Selects the theme for the display.

Screensaver

If you have selected a screensaver, the screensaver appears on the idle screen after the pre-defined time duration.

To select a screensaver

- From the Home screen, select  > **[Display settings]** > **[Screensaver]**.
- In **[Screensaver]**, press  /  and  to select an option:

[None]	shows blank screen.
[Digital clock]	shows time in digits.
[Album art]	shows the CD cover of current song or last played song, if available.
[Screen off]	switches off the screen.
[Demo mode]	shows major features of the player.

To exit the screensaver

- Press any key.

Slideshow settings

[Time per slide]

- Selects play time for each slide.

[Repeat]

- Plays all slides repeatedly, if activated.

[Shuffle]

- Plays all slides in random order, if activated.

Language

You can change the language selection in **[Language]**.

PC connection preference

In **[PC connection preference]**, select how the player is connected to a PC. The player allows the access by a PC through USB Mass Storage Class (MSC), or Media Transfer Protocol (MTP).

[MSC] *allows the player to also work as **Philips Songbird** drive. Click the **Philips Songbird** drive to start the program installation on the PC.

[MTP] during the sync to the player, allows copyright-protected music to be converted to playable formats through **Philips Songbird**.



Tip

- *Make sure that you select **[Enable]** in  > **CD-ROM**.

Information

In **[Information]**, learn the following information about the player:

[Player information]

[Model:] full product name
Check the full product name when updating firmware from the support website.

[Firmware version:]	current firmware version Check the firmware version when updating firmware from the support website.
----------------------------	---

[Support site:]	web site that provides support for the player
------------------------	---

[Disk space]

[Free space:]	space available
----------------------	-----------------

[Total space:]	memory size
-----------------------	-------------

[Songs]	space that songs occupy
----------------	-------------------------

[Pictures]	space that pictures occupy
-------------------	----------------------------

[Videos]	space that videos occupy
-----------------	--------------------------

[File type supported]

[Music]	supported types of music files
----------------	--------------------------------

[Pictures]	supported types of picture files
-------------------	----------------------------------

[Videos]	supported types of video files
-----------------	--------------------------------

Double click on the drive to start the program installation on the PC.



Tip

- After you repair the player, the CD-ROM partition and Philips Songbird installer are removed from the player (see 'Repair the player through Philips Songbird' on page 32). More space is available on the player.

Format device

Format the player. You remove all the data that are stored on the player.

- Select **[Format device]**, and then, select **[Yes]** as prompted.

Factory settings

In **[Factory settings]**, restore the player to factory settings. Files transferred to the player are retained.

CD installer

If you have selected **[MSC]** in * > **[PC connection preference]**, the **[CD installer]** options are displayed.

In **[CD installer]**, select **[Enable]** to allow the player to work as **Philips Songbird** drive.

10 Sync with PC music library through Philips Songbird

With **Philips Songbird**, you can do the following:

- Manage your music collection on a PC;
- Sync **VIBE** with your PC music library;
- Register **VIBE** on www.philips.com/welcome;
- Update the firmware of **VIBE** (see 'Update the firmware through Philips Songbird' on page 31);
- Repair **VIBE** (see 'Repair the player through Philips Songbird' on page 32).

Install Philips Songbird

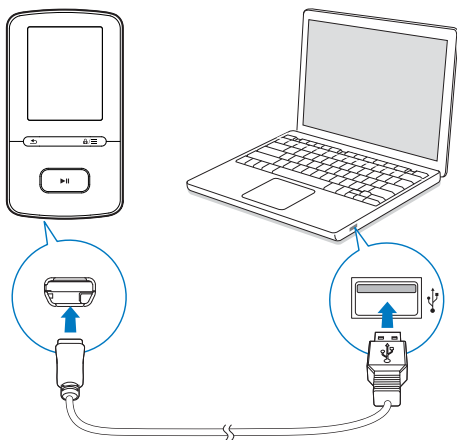

Install Philips Songbird for the first time

When you connect **VIBE** to a PC for the first time, a pop-up screen is displayed:

- 1 Select your language and country.
- 2 Follow the onscreen instructions to complete the installation.

Note

- The installation requires you to agree to the license terms.

If the pop-up screen is not displayed automatically:

- 1 On the player, make sure that you have selected the following options:
 - In *** > [CD installer]**, select **[Enable]**.
- 2 On the PC, select **My Computer** (Windows XP / Windows 2000) / **Computer** (Windows Vista / Windows 7).
↳ The **Philips Songbird** drive is displayed.
- 3 To install **Philips Songbird**, double-click **Setup.exe** in the **Philips Songbird** drive.

Note

- The installation requires you to agree to the license terms.

Collect music files from the PC

Set the watch folder

Create a central folder

You can have all music files automatically added to your library when you copy them to a folder. Creating a central folder is recommended. In **Philips Songbird**, set the central folder as the watch folder. Each time you launch **Philips Songbird**, songs are added to/ removed from **Philips Songbird** as they are on the central folder.

On the PC, create a central folder to save all music files, for example, D:\Songbird media.

First-time launch

The first time you launch **Philips Songbird** on a PC, do the following as prompted to import existing media files into **Philips Songbird**:

- Select the iTunes media folder to import an existing iTunes library;
- Select the central folder to search and import the existing music files.
↳ The central folder is set as the watch folder of **Philips Songbird**.

Set iTunes media folder

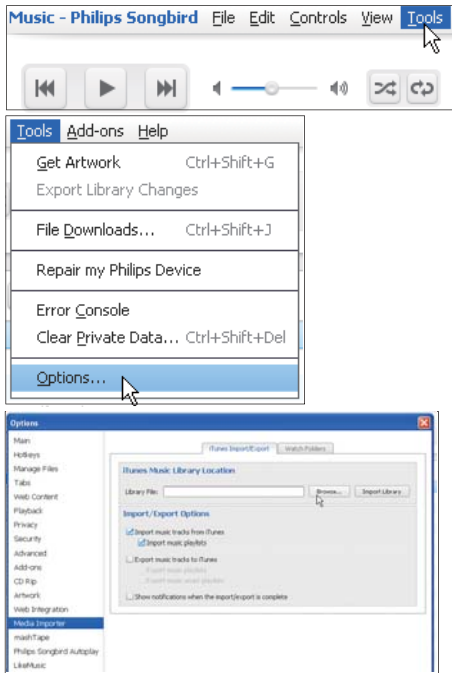

- 1 On **Philips Songbird**, go to **Tools > Options...**
- 2 Select **Media Importer**, and then the **iTunes Importer** tab.
- 3 Verify your library location and options.
- 4 Click the **Import Library** button next to the library location.
↳ The software imports the iTunes library into **Philips Songbird**.

Set the watch folder

In **Philips Songbird**, set the watch folder as follows:

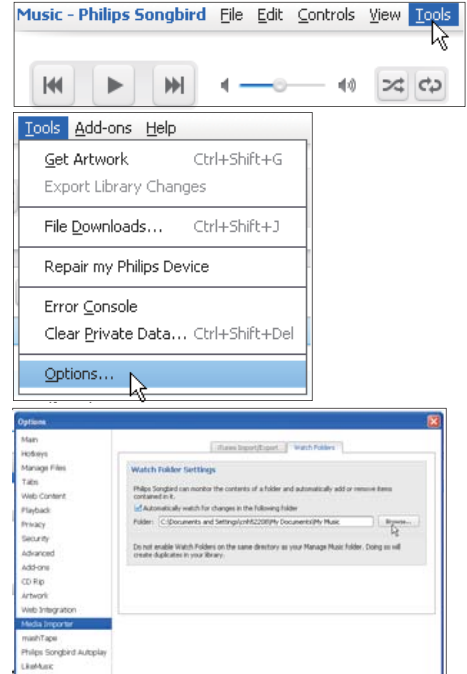

- 1 Select **Tools > Options**.
- 2 In **Options**, select **Media Importer**. Then, select the **Watch Folders** tab.
- 3 In **Watch Folders**, tick the check box as shown.
- 4 Click **Browse**, and select the central folder (e.g. D:\Songbird media) as the watch folder.
↳ In **Philips Songbird**, media files are added or removed as they are in the central music folder:

Import media files

Import media files from other folders

In **Philips Songbird**,

- go to **File > Import Media** to select folders on the PC.

↳ Media files are added under **Library**.

- or, go to **File > Import a playlist** to select playlists on the PC.
 - ↳ Media files are added under **Playlists**.

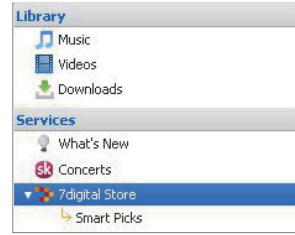
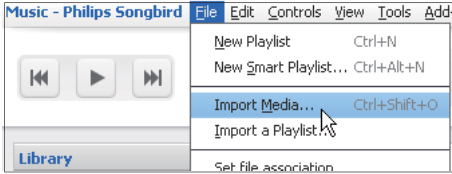

↳ You enter the Web page of the online source.

- 2 Search for your media file.
 - If necessary, use the search box to enter a keyword.

Get contents from online sources

You can access and purchase content from online sources. Find the available online services under **Services** on the source selector pane.

Note

- Before you download or purchase content from online services, subscribe to the online service and log in to your account.
- Some of the services are available in certain countries.

Create playlists in Philips Songbird

With a playlist, you can manage and sync your songs as needed.

Create a playlist

Select songs that you want to play. Add the songs to a playlist.

Search online

- 1 Select an online service:
 - Select an option under **Services**;
 - Alternatively, in the search box, click the down arrow to select an online service.

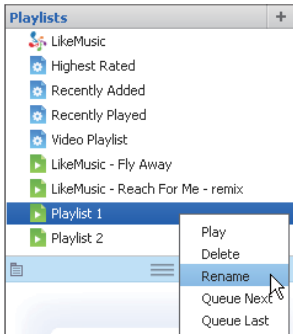
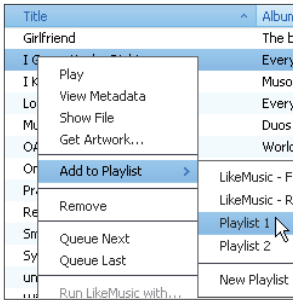

- 1 In **Library** > **Music**, select songs.
 - To select multiple songs, hold down the **Ctrl** button when you click songs.
- 2 To add the songs to a playlist:
 - Right click on the songs, and select **Add to Playlist**;
 - Select a playlist;
 - ↳ The songs are added to the playlist.
 - To create a playlist, select **New Playlist**.
 - ↳ A new playlist is created for the songs.
 - ↳ Under **Playlists**, name the playlist as needed.

Alternatively,
Create a playlist. Add selected songs to the playlist.

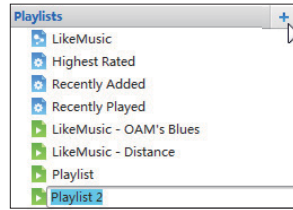

- 1 Under **Playlists**, click **+** to create a playlist.
 - ↳ A new playlist is created.
- 2 Name the new playlist as desired.
- 3 Drag and drop media files to the playlist.



Tip

- To drag and drop multiple files at the same time, hold down the **Ctrl** button when you click on selections.

Generate LikeMusic playlists

Based on the **LikeMusic** analysis, a playlist can be generated from a seed song. **LikeMusic** analyzes songs in your library and, based on their music characteristics, creates relationships between them. These relationships help **LikeMusic** to create playlists of songs that sound great together. When you import songs into the music library of **Philips Songbird**, the **LikeMusic** analysis starts. For the song that completes the analysis, the **LikeMusic** icon lights up; For the song that cannot complete the analysis, the icon remains gray.



Select a seed song

Make sure that the seed song has completed the LikeMusic analysis.

- In **Library > Music**, double click the blue LikeMusic icon of the song;

Alternatively,

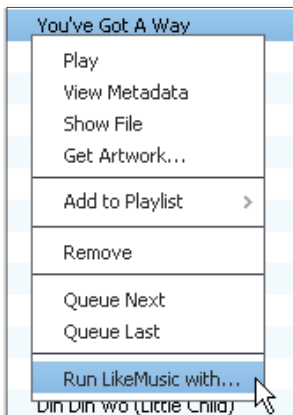

- In **Library > Music**, right click on a song and select **Run LikeMusic with...**
↳ A LikeMusic playlist is displayed in the LikeMusic page.

Set the maximum number of songs

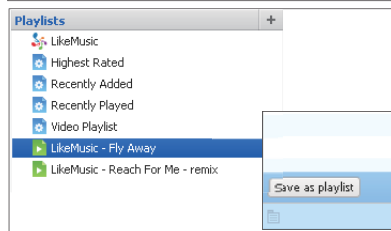

- Select a number in the drop-down list.

Save the LikeMusic playlist

- Click **Save as playlist** in the LikeMusic page.
↳ The LikeMusic playlist is saved under **Playlists**.

Save the play queue as a playlist

Create a play queue

- Drag and drop songs or playlists to the **Play Queue** pane.

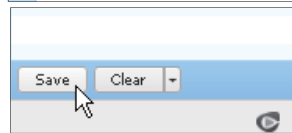

Save the play queue as a playlist

- Click **Save**.
↳ The play queue is saved as a playlist under **Playlists**.

2 Under **Playlists**, name the playlist as needed.

Add songs to the top or end of the play queue

- To add songs to the top, right click on the options and select **Queue Next**;
- To add songs to the end, right click on the options and select **Queue Last**.

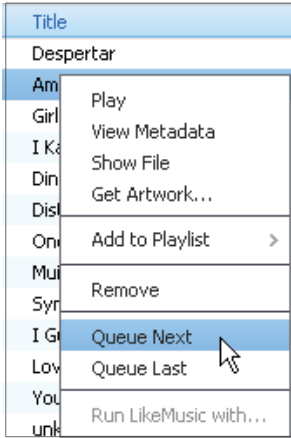

Play a playlist

- 1 To play the entire playlist, right click on the playlist and select **Play**.
 - To start play from a song, double click on the song.
- 2 To select play options, click buttons on the player pane.

Manage media files in Philips Songbird

Edit metadata

By editing file information (metadata or ID3 tag), you can have music files sorted automatically by song title, artist, album, and other information.

After you sync the media files to the player, you can browse the media library by metadata.

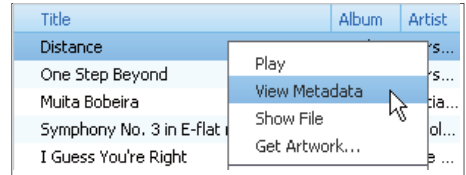

- 1 In **Library > Music**, select a music file.
- 2 Right click on the file to select **View Metadata**.
 - ↳ A metadata table is displayed for you to edit the information.

Get album artwork

Artwork is sometimes available for music downloads. With **Philips Songbird**, you can insert artwork for songs.

After you sync the songs to some players, you can browse the media library by artwork.

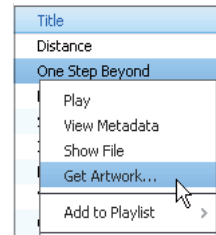

- On **Philips Songbird**, select **Tools > Get Artwork**.
 - ↳ Artwork is fetched for all titles in the library.
- Right click on selected titles, and select **Get Artwork**.
 - ↳ Artwork is fetched for all selected titles.

Remove media files from the library

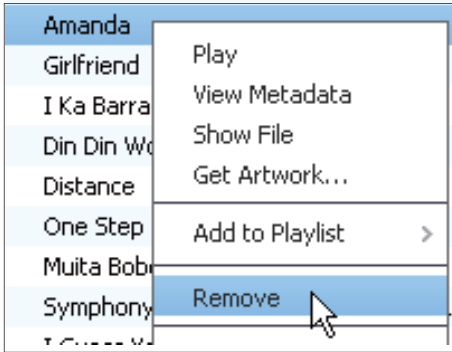

- 1 Right click on a media file. Select **Remove**.
- 2 Confirm as prompted.
↳ The selected file is removed from the library and from all playlists. (By default, the file is only "removed", not "deleted". The file still exists in its original location on the computer or computer network.)



Tip

- To select multiple files, hold down the **Ctrl** button when you click on selections.
- To select multiple consecutive files, hold down the **Shift** button when you click on the first and last selections.

Sync the player with Philips Songbird

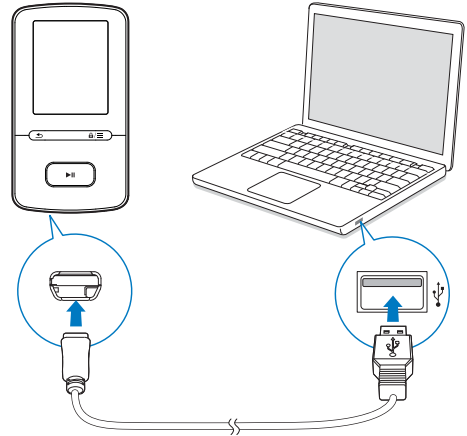

- 1 On the PC, launch **Philips Songbird**.
- 2 Connect the player to the PC by using the USB cable.
↳ On **Philips Songbird**, the player is displayed when it is recognized by the PC.

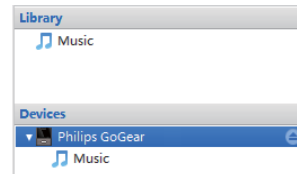

Select auto or manual sync

The first time you connect the player to **Philips Songbird**, select auto sync as prompted. The player sync with **Philips Songbird** automatically. If you do not select auto sync, you switch on the manual sync.

To select auto or manual sync,

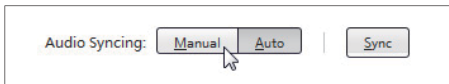
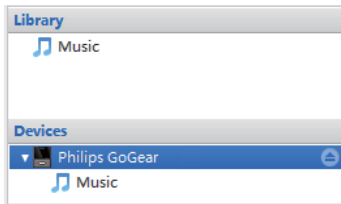

- 1 Select the player under **Devices**.
↳ A pop-up screen is displayed.
- 2 On the pop-up screen, select **Manual** or **Auto**.
- 3 To confirm the option, click **Apply**.

Auto sync

- If you have selected auto sync, auto sync starts automatically when you connect the player to a PC;
- Alternatively, select the player under **Devices**, and click **Sync**.

To select auto sync settings,

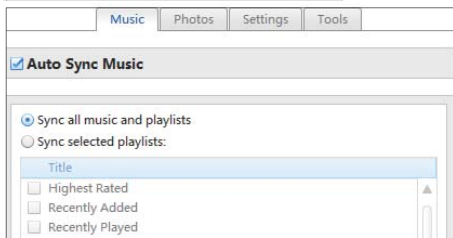
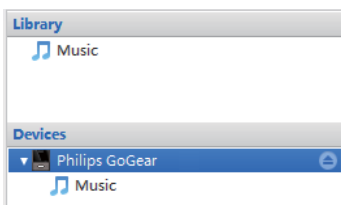

- 1 Select the player under **Devices**.
- 2 On the pop-up screen, click the **Music** tab.
- 3 Click to select an option.

Manual sync

To transfer selected playlists manually,

- 1 Select playlists.
- 2 Drag and drop the playlists to **VIBE**.

To transfer selected media files manually,

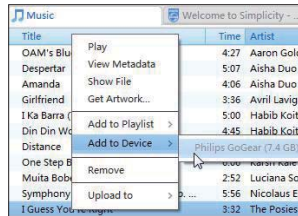

- 1 On the Content pane, right click on a selected media file.
- 2 Select **Add to Device > VIBE**.
↳ Selected files are transferred to **VIBE**.

Tip

- To select multiple files at the same time, hold down the **Ctrl** button when you click options.

11 Update the firmware through Philips Songbird

VIBE is controlled by an internal program called firmware. Newer versions of the firmware may have been released after you have purchased VIBE.

Through **Philips Songbird**, you can check for and install firmware updates for VIBE over the Internet.



Tip

- Your music files are not affected by a firmware update.

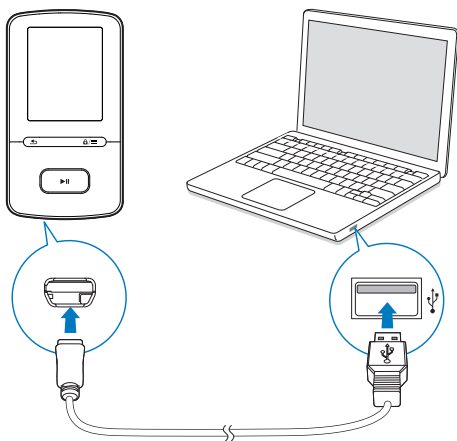

- 1 Make sure that you have connected your PC to the Internet.
- 2 Connect **VIBE** to the PC by using the USB cable.
- 3 On the PC, launch **Philips Songbird**.
 - If necessary, click **Start > Programs > Philips > Philips Songbird**.

- 4 Click **VIBE** in the Player pane. Then, select **Tools > Check for updated firmware** in the pop-up window.

↳ **Philips Songbird** checks for updates and installs new firmware from the Internet, if available.

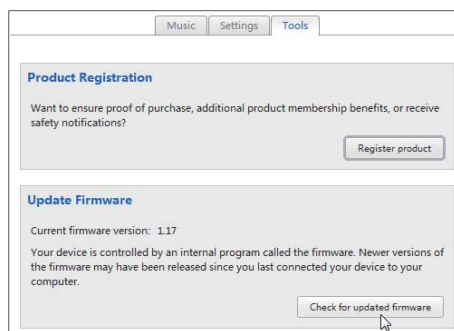
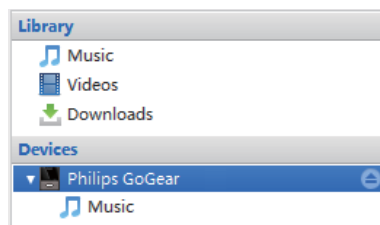

- 5 Follow the onscreen instructions.
 - ↳ Downloading and installation of firmware update start automatically.
 - ↳ The **VIBE** restarts after the firmware is updated and is ready for use again.



Note

- Wait until the update is completed, then disconnect the **VIBE** from the computer.

12 Repair the player through Philips Songbird

If VIBE is not working properly or the display freezes, you can reset it without losing data:

To reset VIBE?

- Insert a pen tip or other object into the reset hole located at the base of VIBE. Hold until the player shuts down.

If you fail to reset the player, repair the player through Philips Songbird:

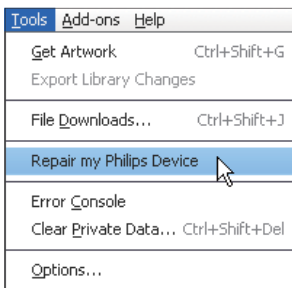

- 1 On your PC, launch **Philips Songbird**.
- 2 In **Philips Songbird**,
 - select **Tools > Repair my Philips Device**;
 - select **VIBE** in the pop-up list.
- 3 Connect the player to the PC.
 - **Make sure that you follow the onscreen instructions on how to connect the player to the PC.**
- 4 Follow the onscreen instructions to complete the repair:

Tip

- After you repair the player, the CD-ROM partition and the **Philips Songbird** installer are removed from the player. More space is available on the player.

13 Technical data

Power

- Power supply: 290 mAh Li-ion polymer internal rechargeable battery
- Play time¹
Music (.mp3): up to 20 hours (FullSound off); up to 12 hours (FullSound on)
Video (.mp4): up to 4 hours

Software

- Philips Songbird: to update firmware and transfer³ music
- Philips Media Converter: to convert and transfer³ videos

Connectivity

- Headphone 3.5 mm
- USB 2.0 High speed

Sound

- Channel separation: > 45 dB
- Frequency Response: 80-18,000 Hz
- Output power: 2 x 2.4 mW
- Signal to noise ratio: > 84 dB

Audio playback

Supported formats:

- MP3
Bitrate: 8-320 kbps and VBR
Sampling rates: 8, 11.025, 16, 22.050, 32, 44.1, 48 kHz
- WMA (unprotected)
Bitrate: 5-320 kbps
Sampling rates: 8, 11.025, 16, 22.050, 32, 44.1, 48 kHz
- FLAC
Bitrate: up to 1.1 Mbps
Sampling rates: 48 kHz
- APE
Bitrate: up to 1.3 Mbps
Sampling rates: 48 kHz

Video playback

Supported formats:

- SMV

Picture display

Supported formats:

- JPEG

- BMP

Storage media

Built-in memory capacity²:

- SA4VBE04 4GB NAND Flash
- SA4VBE08 8GB NAND Flash
- SA4VBE16 16GB NAND Flash

Media transfer³

- Songbird (music sync)
- Media Converter (video transfer)
- Windows Explorer (drag and drop)

Display

- Color LCD 128 x 160 pixels



Note

- Specifications are subject to change without notice.
- ¹ Rechargeable batteries have a limited number of charge cycles. Battery life and number of charge cycles vary by use and settings.
- ² 1GB = 1 billion bytes; available storage capacity is less. Full memory capacity may not be available as some memory is reserved for the player. Storage capacity is based on 4 minutes per song and 128 kbps MP3 encoding.
- ³ Transfer speed depends on operating system and software configuration.

PC requirements

- Windows® XP (SP3 or above) / Vista / 7
- Pentium III 800 MHz processor or higher
- 512 MB RAM
- 500 MB hard disk space
- Internet connection
- Windows® Internet Explorer 6.0 or later
- CD-ROM drive
- USB port

