

hp
photosmart
720 series
digital
camera



user's manual



i n v e n t

Trademark and copyright information

© Copyright 2002 Hewlett-Packard Company

All rights are reserved. No part of this document may be photocopied, reproduced, or translated to another language without the prior written consent of Hewlett-Packard Company.

The information contained in this document is subject to change without notice. Hewlett-Packard shall not be liable for errors contained herein or for consequential damages in connection with the furnishing, performance, or use of this material.

Microsoft® and Windows® are U.S. registered trademarks of Microsoft Corporation.

Apple, Macintosh, and Mac are registered trademarks of Apple Computer, Inc.



SD Logo is a trademark.

Materials disposal

This HP product contains the following materials that might require special handling at end-of-life:

- Mercury in the fluorescent lamp in the image LCD.
- Alkaline manganese dioxide-zinc or lithium-iron disulfide AA batteries.
- Lead in the solder and some component leads.

Disposal of this material can be regulated because of environmental considerations. For disposal or recycling information, please contact your local authorities or the Electronic Industries Alliance (EIA) (www.eiae.org).

Table of Contents

1-Getting started	9
Camera Parts	10
Setup	15
Attaching the wrist strap	15
Installing the batteries	15
Inserting the memory card (optional)	16
Turning on power	16
Choosing the language	17
Setting the date and time	17
Installing the software	18
Windows	18
Macintosh	19
2-Taking pictures	21
Taking still pictures	21
Using focus lock	21
Using instant review	22
Recording video clips	22
Recording audio	23
Using preview mode	23
Using the self-timer and burst features	24
Using the self-timer	24
Using burst	24
Using zoom	25
Optical zoom	25
Digital zoom	25
Using the flash	26
Changing the image quality	27

3-Using playback and the main menu	29
Using playback to view images	29
Using the main menu	31
Rotating images	32
Deleting images	32
Recording audio clips	33
Viewing thumbnail images	34
Magnifying images	34
Using the setup menu	35
Exposure settings	36
Date & time	38
Welcome screen	38
USB configuration setting	39
Move images to card	40
Language	40
4-Using hp instant share	41
Using hp instant share to print pictures	43
Using the hp instant share e-mail service	44
Adding, modifying, and removing e-mail addresses	44
Selecting images to be e-mailed	45
Windows	46
Macintosh	46
5-Unloading, printing, & displaying images	47
Unloading to a computer	47
Printing images	48
Displaying images on a TV	49
Displaying a slideshow	49

6-Troubleshooting and support	51
Problems and solutions	51
Error messages	56
Error messages on the camera	56
Error messages on the computer	59
Getting assistance	60
Finding help on the web	60
HP product support	60
HP photosmart website	60
HP accessibility website	60
Contacting hp customer support	60
How hp can help	60
Before you call	61
Obtaining support in the United States	61
Free telephone support for one year	61
After the first year	61
Upgraded warranty options	62
Obtaining support worldwide	62
Hewlett-Packard limited warranty statement	66
Regulatory information	67
Appendix A: Batteries and accessories	69
Managing batteries	69
Extending battery life	70
Rechargeable batteries	70
Power conservation	71
Purchasing accessories	71
Appendix B: Camera dock	73
Unloading images to a computer using the dock	75
Printing images using the dock	76
Displaying images on a TV using the dock	76
Appendix C: Specifications	77

1 Getting started

The HP Photosmart 720 digital camera is a 3.3 mega-pixel camera with 3x optical zoom and 4x digital zoom. This camera has an exciting new feature called **HP Instant Share** technology.

With **HP Instant Share**, you can select images to print or e-mail automatically the next time you connect the camera to your computer. You can also bypass the computer altogether and print the selected pictures directly to any HP Deskjet or Photosmart printers that are USB-enabled.



You can enhance your experience by purchasing an HP Photosmart 8881 Camera Dock. The Camera Dock allows you to easily download images to a computer, send images to a printer or television, recharge the camera batteries, and provide a convenient home for your camera.

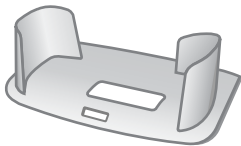

NOTE A Dock Insert is included in your camera box. This Dock Insert enables your camera (and others of the same model) to use the HP Camera Dock. Please do not use it without the Camera Dock and **DO NOT** discard it. Instructions for its use are included with the Camera Dock as well as in Appendix B of this manual.

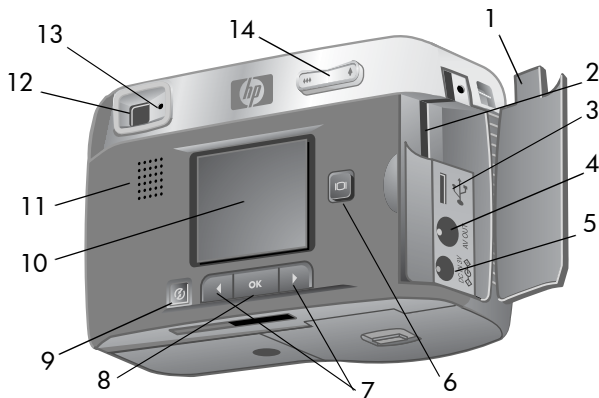

Camera Parts







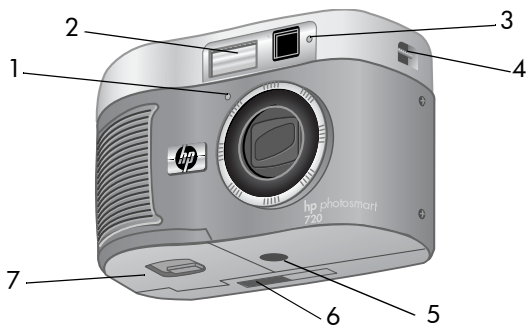

#	Name	Description
1	Memory card door	Allows access to insert or remove the memory card. Also allows access to the connectors for USB, TV, and power adapter.
2	Memory card slot	Allows memory card to be inserted
3	USB connector	Provides connection to either a computer or printer
4	TV connector	Provides audio/video output to a TV
5	Power adapter connector	Provides connection for an optional HP AC adapter
6	 Display button	Turns on Preview mode or turns off the Image Display
7	 Arrow buttons	Moves to menu options and navigates through images

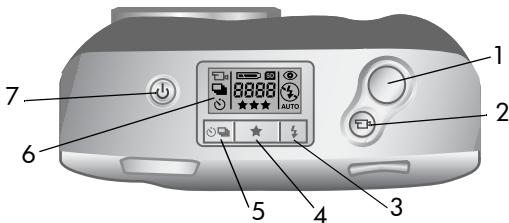
#	Name	Description
8	OK button	Press once to turn on Playback mode, again to turn on Main menu. Also selects menu options
9	 Share button	Turns the Share menu on and off
10	Image Display	Provides menu information to operate the camera. You can also preview the picture before taking it and review it afterward
11	Speaker	Plays camera sounds and audio clips
12	Optical viewfinder	Allows you to frame the subject of the picture
13	Viewfinder light	<p>Solid green - camera is recording video or ready to take a still picture</p> <p>Blinking green - camera unable to focus or long exposure (hold steady)</p> <p>Blinking yellow - camera is charging the flash or saving images to memory</p> <p>Blinking red - camera is either: starting up, charging the battery, sending/receiving USB, counting down self-timer, or there is an error (turn on Image Display to see message)</p>
14	 Zoom Out/In button	Allows you to zoom in and out



#	Name	Description
1	Microphone	Records audio clips
2	Flash	Provides additional light to improve picture-taking
3	Video/Self-timer light	Solid red - camera is recording video Blinking red - self-timer is activated
4	Wrist/Neck strap mount	Wrist strap attachment (there is a mount on both sides of the camera in case you want to attach a neck strap)
5	Tripod mount	Allows camera to be mounted to a tripod
6	Camera Dock connector	Provides connection to the optional HP Camera Dock
7	Battery door	Allows access to the batteries



#	Name	Description
1	Shutter button	Takes a picture
2	 Video button	Records a video clip; press once to start and press again to stop
3	 Flash button	Selects the Flash setting
4	 Quality button	Changes image quality from Good to Better to Best
5	 Self-timer/Burst button	Sets the Self-timer when pressed once, and sets the Burst feature when pressed twice
6	Status LCD	Displays camera settings and operating status (see the following illustration)
7	 Power button	Turns the camera power on and off

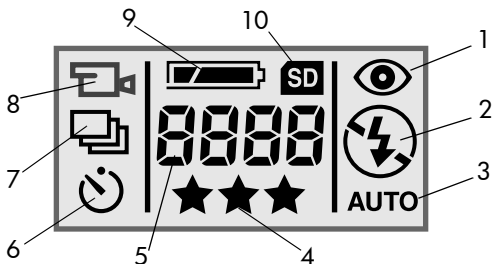

#	Icon	Indicates
1		Red-eye Reduction is active
2	 or 	Flash On is active or Flash Off is active
3	AUTO	Auto Flash is active
4	★★★	Image quality selection
5	0000	Number of images remaining
6		Self-timer is active
7		Burst feature is active
8		Video is being recorded
9		Battery condition
10		SD memory card is in the camera

Setup

Attaching the wrist strap

Attach the wrist or neck strap as shown in the illustration.

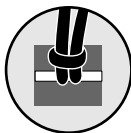
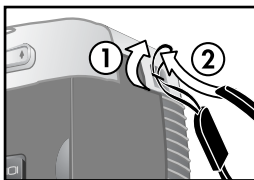

NOTE It is easiest to install the strap by inserting it from the bottom of the strap mount first.

Installing the batteries

- 1 With the front of the camera facing you, slide the latch on the battery door to the right.
- 2 Holding on to the latch, pull the battery door toward you.
- 3 Insert the batteries as indicated inside the door.



NOTE For more information about batteries, refer to **Managing batteries** on page 69.

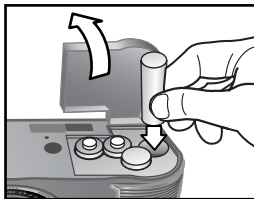

Inserting the memory card (optional)

Your digital camera contains 16 megabytes (MB) of internal memory so that you can store images and video clips in your camera. However, you can use an optional memory card (purchased separately) to expand the camera's memory to store more images and video clips

NOTE Your camera supports up to a 128 MB memory card.

After unloading images to your computer, you can reuse the card.

- 1 With the camera off, open the memory card door.
- 2 Insert the memory card as shown.
- 3 Close and fasten the memory card door.

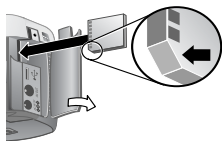

To remove the card, pull it out of the camera.

Turning on power

Press the Power  button to turn on the camera. When the camera is ready, the viewfinder light stops blinking.



Choosing the language

The first time you turn the camera on, the following screen appears and prompts you to choose a language.

- 1 Scroll to the language that you want by using the **Arrow** ◀ ▶ buttons.
- 2 Press **OK** to select the highlighted language.



Setting the date and time

The camera has a clock that records the date and time at which you take each picture.

- 1 Press the **OK** button repeatedly until your preferred date format appears, and then press the right **Arrow** ▶ button to highlight the date.
- 2 Press **OK** to select the first value, and then use the ◀ ▶ buttons to change it. Press **OK** to confirm. Set the remaining values in the same way. (M = Month, D = Day, Y = Year)
- 3 Press the ▶ button to highlight the time format, and then press **OK** if you want to change it.
- 4 Press the ▶ button to highlight the time. Set the time values in the same way you set the date values in step 2.
- 5 When finished setting the date and time, press the ▶ button to highlight **Exit**, and then press **OK**.

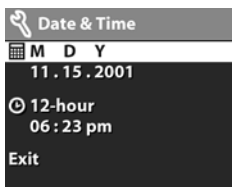

Installing the software

The camera software allows you to unload images from the camera, view them, print them, and e-mail them. It also allows you to configure the **Share** menu on the camera.

NOTE For Windows computers, the HP Photo & Imaging software needs at least Internet Explorer 5.0 (Service Pack 2) in order to function properly.

Windows

1 Insert the HP Photo & Imaging CD into the CD drive of your computer. The installation window automatically appears.

NOTE If the installation window does not appear, click **Start**, and then click **Run**. Type `X:\Setup.exe`, where **X** is the letter of your CD drive.

2 Click **Next**, and then follow the on-screen instructions to install the software.

To install any bonus software:

1 Click **Start**, click **Run**, and in the **Open** box, type `X:\Bonus\setup.exe` (where **X** is the drive letter of your CD drive).

2 Click **OK**, and then follow the on-screen instructions to install the bonus software.

Macintosh

- 1** Insert the HP Photo & Imaging CD into the CD drive of your computer.
- 2** Double-click the CD icon on the desktop.
- 3** Double-click the installer icon, then follow the instructions on the screen to install the software.

To install any bonus software:

- 1** Double-click the **Bonus** folder icon.
- 2** Double-click the installer icon for the bonus software.
- 3** Follow the on-screen instructions to install the software.

2 Taking pictures

Taking still pictures

You can take a picture almost any time the camera is on, regardless of what is being shown on the Image Display. To take a picture:

- 1 Frame the subject that you want to photograph in the viewfinder.
- 2 Hold the camera steady, and press the **Shutter** button. The camera automatically adjusts focus and exposure, and then takes the picture.



When you press down the **Shutter** button, you may notice that the viewfinder light is red, yellow, or green, and may or may not be blinking. See the description for **Viewfinder light** on page 11.

NOTE To achieve best focus in low light conditions, secure the camera to a tripod and make sure the focus area has sufficient contrast.

Using focus lock

Focus Lock allows you to focus on a subject that is not in the center of the image. It is also useful to verify that your image is in focus before taking the picture. To use **Focus Lock**:

- 1 Press the **Shutter** button halfway down to lock the exposure and focus. When exposure and focus are locked, the green Viewfinder light comes on solid.



- 2 When exposure and focus are locked, and you continue to hold the **Shutter** button halfway down, you can re-frame or adjust your subject for proper positioning.
- 3 Press the **Shutter** button all the way down until you hear a click and see the image on the Image Display in **Instant Review**.

Using instant review

After you take a picture, the Image Display shows the image while it is being saved to memory. You can delete the image before it is saved by pressing the ◀ button.

Recording video clips

To record a video clip with audio for up to 30 seconds:

- 1 Frame the subject that you want to record.
- 2 Press and release the **Video**  button to start recording; **REC** appears on the Image Display.
- 3 To stop recording, press the  button again. The camera automatically stops recording when the maximum clip length of 30 seconds is reached or memory is full.



After recording has stopped, the last frame of the video clip remains on the Image Display during Instant Review. During this time, the video clip is saved to memory unless you choose to delete it.

During video recording, the green viewfinder light and the red Video/Self-timer light are on, and you can view the time remaining on the Image Display. The camera automatically stops recording when the timer reaches zero. You can delay recording a video clip for 10 seconds by setting the self-timer.

Recording audio

After you take a still picture, you can add an audio annotation to it (for example to describe the location of the picture). For the details on how to do this, see **Recording audio clips** on page 33.

Using preview mode

You can use the Image Display as a viewfinder and show a more accurate view of what your picture will look like. This is useful for close-up photos and for instances in which framing your subject precisely is important. To take a picture by using the Image Display:

- 1 Press the **Display**  button to activate Preview mode.
- 2 Frame your subject in the Image Display, and then press the **Shutter** button.

In the Preview screen, the current image quality setting (1, 2, or 3 stars) is shown in the lower-left corner, with the remaining picture count to the right of the image quality icons. If you selected any manual exposure settings, they are displayed on the top of the screen.





In addition to taking pictures and recording video, you can zoom in on your subject, adjust the flash setting, or increase the quality of your image—all from within Preview mode.

NOTE Using the Image Display consumes a large amount of battery power.

Using the self-timer and burst features



The Self-timer/Burst  button activates the Self-timer and Burst features on the camera.

Using the self-timer

- 1 Secure the camera to a tripod or set it on a stable surface.
- 2 Turn the camera on, and then frame your subject in the viewfinder.
- 3 Press the  button until the Self-timer icon  appears on the Status LCD.
- 4 Press the **Shutter** button all the way down, and then release it. The **Video/Self-timer** light on the front of the camera blinks for 10 seconds before the picture is taken.

Using burst

Burst is used to take multiple pictures in a row as quickly as the camera can. To use Burst:

- 1 Press the  button until the **Burst**  icon appears on the Status LCD.
- 2 Frame the subject and press the **Shutter** button all the way down and hold it.
- 3 Flash is disabled and the camera takes pictures as quickly as possible until the memory is full or the **Shutter** button is released.



Using zoom

Optical zoom

Press the **Zoom Out/Zoom In**  button to move the lens between wide angle and telephoto positions (1 to 3x).

You cannot adjust optical zoom while recording video clips.

Digital zoom

- 1 Press the **Display**  button to turn on **Preview** mode, and then frame the picture using the Image Display.
- 2 Use the **Zoom in**  button to optically zoom in to the maximum level, then release the button.
- 3 Press the  button again and hold it until you reach the desired size in the Image Display. A yellow border surrounds the area of the image that will be captured.
- 4 Make sure the yellow border frames your subject, and then take the picture.







To turn digital zoom off, press the **Zoom Out**  button until zooming stops, or turn off the Image Display.

Using the flash

When the camera is turned on, the flash is automatically set to **Auto Flash**. If you change the flash setting, the camera will remain in that setting until you change it again or turn off the camera.

To set the flash, press the **Flash**  button until the desired setting appears on the Status LCD. The following table describes the different flash settings:

Icon	Setting	Description
 AUTO	Auto Flash	The camera measures light and uses the flash if necessary.
  AUTO	Red-eye Reduction	The camera measures light and uses the flash with red-eye reduction if necessary.
	Flash On	The camera always flashes. If the light is behind your subject, you can use the flash to increase the light on the front of your subject. This is also called "fill-flash."
	Flash Off	The camera will not flash. Use this setting when you do not want a flash (such as with distant objects). This may result in long exposures that will require using a tripod.

Changing the image quality

The camera has three image quality settings: **Good**, **Better**, and **Best**. The current quality setting is displayed on the Status LCD.

To change the image quality setting, press the **Quality** ★ button until the desired setting appears on the Status LCD.

The following table identifies the approximate number of pictures that you can take at each setting based on internal memory or with a 16 MB memory card (purchased separately).

Setting	Icon	Description and capacity
Good	★	This is the most memory-efficient setting, ideal for images you want to e-mail or post to the Internet. (16 MB memory holds approximately 220 images)
Better	★★	This setting produces high-quality images and requires less memory than Best setting. This is recommended for printing images up to 20 by 25 cm (8 by 10 inches). This is the default quality setting. (16 MB memory holds approximately 18 images)
Best	★★★	This setting produces the highest-quality images and uses the most memory. This is recommended if you plan to enlarge images, or print images to a size larger than 20 by 25 cm (8 by 10 inches). (16 MB internal memory holds approximately 11 images)

3 Using playback and the main menu



Using playback to view images

After you have taken some pictures or video clips and they are stored in the camera, you can view them in Playback mode.

- 1 Press the **OK** button to activate Playback mode. The most recently taken or viewed image appears on the Image Display. If the image is a video clip, it begins playing automatically within a few seconds.
- 2 Scroll through the images by using the **Arrow** ◀ ▶ buttons. Press and hold ◀ or ▶ to scroll automatically. If a video clip is playing, pressing the ◀ button will reset the clip to the first frame of the video clip.

In addition to seeing the images on the Image Display, some information about each image is also displayed above and below the image. The following table describes the information that may be viewed for each image.



#	Icon	Description
1	***	Shows the quality setting for the current image, blank if image is a video clip
2	2X	Digital zoom setting (blank if digital zoom was not used)
3	12 of 43	Shows the current image number from the total number of images taken
4	12.25.2001	Date the image was captured
5	 or 	Visible if the current image has an audio clip attached to it Visible if the current image is a video clip

NOTE To preserve battery life, you can connect to an optional HP AC adapter while viewing your images. For more information about accessories for your camera, see **Appendix A: Batteries and accessories** on page 69.

If you do not have images stored in your camera or on the memory card, the **No images** screen appears on the Image Display.

Using the main menu

Use the Main menu to view or modify images in the camera or to change the camera settings.

- 1 To view the Main menu from Playback mode, press the **OK** button. If the Image Display is off, press the **OK** button twice.
- 2 Scroll through the Main menu options using the **Arrow** **◀ ▶** buttons and select an option with the **OK** button.



The options available in the Main menu are:

Icon	Description
	Rotate - rotates the current image 90 degrees clockwise
	Delete - deletes the current image, all images, or formats internal memory or the memory card. Also lets you undo the last deletion you made.
	Record Audio - allows you to add an audio clip to still images
	View Thumbnails - displays images in camera as thumbnails (nine per page)
	Magnify - magnifies the current image on the Image Display by 3x or 6x
	Setup - allows you to adjust the camera settings
	Exit -exits the Main menu

Rotating images

NOTE This option works only on still images, not video clips.

- 1 In Playback mode, scroll to the image you want by using the ◀ ▶ buttons, then press **OK** to display the Main menu.
- 2 In the Main menu, select the **Rotate**  option. The current image is rotated 90 degrees clockwise. While the image is being rotated, a progress bar appears below the image. If you press **OK** again while the progress bar is displayed, the image is rotated again.

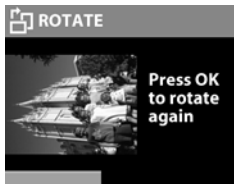

Deleting images

- 1 In Playback mode, scroll to the image you want by using the ◀ ▶ buttons, then press **OK** to display the Main menu.
- 2 In the Main menu, select the **Delete**  option.
- 3 In the Delete menu, highlight your selection, and then press **OK**.



Menu Item	Description
This Image	Deletes the current image
All Images or All Images on Card	Deletes all images from internal memory or the memory card (if installed).
Format Memory or Format Card	Deletes all images and files from internal memory or the memory card (if installed), and formats either internal memory or the memory card

Menu Item	Description
Undelete	Appears if you have deleted any images or video clips. Undelete restores the last deletion you made. This option is available until another picture or video clip is taken, another deletion occurs, or the camera is turned off or connected to your computer
Exit	Exits the Delete menu

Recording audio clips

NOTE This option works only on still images, not video clips.

- 1 In Playback mode, scroll to the image you want by using the ◀ ▶ buttons, then press **OK** to display the Main menu.
- 2 In the Main menu, select the **Record Audio**  option. Recording starts immediately, and the time remaining appears in the lower-left portion of the Image Display. Time remaining is based on free memory or 4:00 minutes, whichever is smaller.
- 3 Press **OK** to stop recording. Within 4 seconds of stopping, you can press the ◀ button to cancel what was just recorded and re-record a new audio clip.



Once an image has an audio clip attached to it, you can go back later and change it by selecting the image, then opening the **Record Audio**  option again.



Viewing thumbnail images

- 1 In Playback mode, press **OK** to display the Main menu.
- 2 In the Main menu, select the **View Thumbnails**  option.
- 3 Scroll through the thumbnail images by using the **◀ ▶** buttons. The current image is highlighted with a yellow border. To move to the next set of images, use the **◀ ▶** buttons
- 4 To view an enlarged image, select it, and then press **OK**.



Magnifying images

NOTE This option works only on still images, not video clips.

- 1 In Playback mode, scroll to the image you want by using the **◀ ▶** buttons, then press **OK** to display the Main menu.
- 2 In the Main menu, select the **Magnify**  option. This magnifies the image to three times its size (it does not permanently alter the image in the camera).
- 3 Scroll left or right in the image by using the **◀ ▶** buttons. To scroll up and down, press **OK** to display the **Magnify** menu, then press **OK** again to select the first icon in the menu. Use the **◀ ▶** buttons to scroll up and down in the image.
- 4 To magnify the image to six times its size, select the **Magnify More**  option. To return to Playback Mode, select the **Exit**  option.



Using the setup menu

The **Setup** menu allows you to set a number of preferences on the camera, including:

- selecting up to three different exposure settings (exposure compensation, white balance, and ISO) to use when taking pictures
- setting date and time
- selecting the image to be used for the welcome screen when the camera is turned on
- setting the USB configuration (how the camera appears when connected to a computer)
- moving images from internal memory to a memory card
- selecting the language the camera interface will use

- 1** In Playback mode, press **OK** to display the Main menu. If the Image Display is off, press **OK** twice to get to the Main menu.
- 2** In the Main menu, select the **Setup**  option.



Exposure settings

Use these settings to override the camera's automatic exposure settings. When you change these settings manually, the current settings appear at the top of the Image Display in Preview mode (except when you are using Digital Zoom).

- 1 In the **Setup** menu, select **Exposure Settings**.
- 2 In the **Exposure Settings** menu, use the ◀ ▶ buttons to scroll to **Exposure Compensation** , **White Balance** **[WB]**, or **ISO** **[ISO]**, and press **OK**.



Exposure compensation

This setting () alters the exposure to compensate for lighting conditions. Settings range from **-1.5** (underexposure) to **+1.5** (overexposure). To determine how much to adjust the setting, take a picture after you change the setting, then examine the image in Playback mode. If the image is too dark, increase the compensation. If the image is too bright, decrease the compensation.

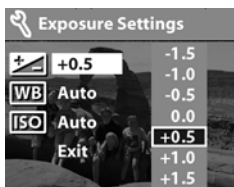

White balance

In some cases, it may be necessary to pre-set the light source so the camera can reproduce colors more accurately. Set the White Balance (**WB**) according to the following situations.



Icon	Description
Auto	Auto - this is the default setting
	Daylight - recording outdoors on a bright day
	Cloudy - recording under overcast or twilight skies
	Tungsten - recording under incandescent lighting
1	Fluorescent 1 - recording under cool or daylight fluorescent lighting
2	Fluorescent 2 - recording under warm fluorescent lighting

ISO

This setting (**ISO**) adjusts how quickly the camera reacts to light. Higher ISO numbers allow higher shutter speeds. Switch to higher speeds while taking pictures in dark areas or fast moving objects.



NOTE Higher ISO numbers can decrease image quality, so use as low an ISO speed as possible.

Date & time

This setting determines the current date and time for the camera. This is usually done when you first set up the camera, but you may need to re-set the date and time when you are travelling to different time zones or when the batteries are out of the camera for more than 10 minutes.

- 1 In the **Setup** menu, select **Date & Time**.
- 2 Follow the same procedure used in **Setting the date and time** on page 17.

Welcome screen

This setting determines the image that appears when the camera is turned on. You can select any image available in the camera or the HP logo, which is the default setting.

- 1 In Playback mode, scroll to the image you want by using the ◀ ▶ buttons, then press **OK** to display the Main menu.
- 2 In the Main menu, select the **Setup** ⚙ option.
- 3 In the **Setup** menu, select **Welcome Screen**.
- 4 Select **This Image** to use the current image, **HP Logo** to return to the factory setting, or **Exit** to leave the current welcome screen unchanged.
- 5 Press **OK** to activate the selection you made in the previous step.



USB configuration setting

This option determines how the camera appears when connected to a computer.

- 1 In the **Setup** menu, select the **USB Configuration** option.
- 2 In the **USB Configuration** menu, use the **Arrow** ◀ ▶ buttons to make one of the following choices and press **OK**.
 - **Digital Camera** - causes the computer to recognize the camera as a digital camera (Picture Transfer Protocol (PTP) standard). This is the default setting on the camera.
 - **Disk Drive** - causes the computer to recognize the camera as a disk drive (Mass Storage Device Class (MSDC) standard). Use this setting for unloading and sharing on a Macintosh computer or on Windows system that does not have the HP Photo & Imaging software installed on it.

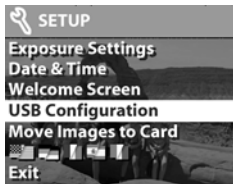

Move images to card

This option lets you move images from the camera's internal memory to a memory card. It appears only if a memory card is installed and internal memory contains at least one image.

- 1 In the **Setup** menu, select the option **Move Images to Card**.
- 2 If the memory card can store all of the images from internal memory, you are prompted to move all images. If the memory card is running out of space, you can move only the number of images that will fit on the card. If you select **Yes** to move images, they are moved to the card, and all moved images are deleted from internal memory.

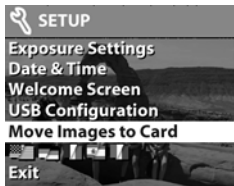

NOTE When a memory card is inserted, only the images on the card can be viewed on the Image Display. To view the images stored in internal memory, remove the memory card.

Language

This setting determines the language of the menus and the text on the Image Display.



- 1 In the **Setup** menu, select the **Language** option.
- 2 Follow the same procedure used in **Choosing the language** on page 17.

4 Using hp instant share

This camera has an exciting feature called **HP Instant Share**. This feature lets you select images in the camera to be automatically processed later when the camera is connected to your computer or to certain HP printers.





For example, you can select images that you want to have printed, then connect the camera to the computer or printer, and the selected images will be printed automatically.

As another example, you can select images in the camera to be automatically processed by HP's e-mail service. When the camera connects to your computer, the selected images are e-mailed to family, friends, or any e-mail address that you specify. The details about this are explained later in this chapter.

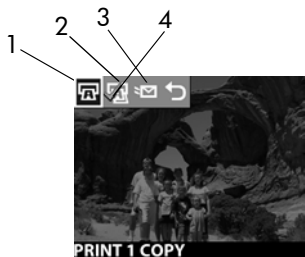

When you press the **Share**  button on the camera, the most recently taken or viewed image appears on the Image Display, along with any e-mail or print destinations that have been selected for the image. The   buttons allow you to scroll through the images to see destinations for the other images in the camera.

After you press the **Share**  button, you can activate the **Share** menu by pressing **OK**. The following illustration and table provide information about the **Share** menu.



#	Icon	Description
1		<p>Print 1 copy of current image.</p> <ul style="list-style-type: none"> • On 4 by 6 inch paper, the picture is printed 4 by 6 inches (or 10 by 15 cm). • On 8.5 by 11 inch paper, up to two 4 by 6 inch pictures (Windows) or three 4 by 6 inch pictures (Macintosh) are printed. • On A4 paper, up to two A6 size pictures are printed per page. • On A6 paper, the picture is printed at A6 size.
2		Print 2 copies of current image.
3		E-mail... Lets you add e-mail addresses to the Share menu. This procedure is explained later in this chapter.
4		Check mark indicates the destination has been selected for the currently displayed image. (You can select more than one destination per image.)

Using hp instant share to print pictures

- 1 Turn on the camera, then press the **Share**  button.
- 2 Use the **◀ ▶** buttons to scroll to the image you want to print. Video clips cannot be selected for printing.
- 3 Press **OK** to activate the **Share** menu, then use the **◀ ▶** buttons to scroll to the print option you want.
- 4 Press **OK**, and a **✓** appears next to that option.
- 5 Scroll to other images by using the **◀ ▶** buttons and repeat steps 3 and 4 to select print options for each image.
- 6 When you are finished selecting all the images you want to have printed, press the **Share**  button.
- 7 The next time you connect the camera to your computer or a compatible printer, the images you selected will be automatically printed. See **Chapter 5: Unloading, printing, & displaying images** on page 47 for information about connecting the camera to a computer or printer.

NOTE The **Share** menu creates a standard Digital Print Order Format (DPOF) file for print options.



Using the hp instant share e-mail service

Using HP Instant Share to e-mail images involves three steps:

- 1 Adding e-mail addresses to the camera's **Share** menu (using your computer and the camera together).
- 2 Selecting images to be e-mailed (using the **Share** menu on the camera).
- 3 Connecting the camera to your computer to send selected images.

Adding, modifying, and removing e-mail addresses

NOTE You will need an internet connection to complete this procedure.

- 1 Turn on the camera, press the **Share**  button, then select the **E-mail...**  option and press **OK**. A message on the camera Display appears asking you to connect the camera to your computer.
- 2 Connect the camera to your computer (by using the USB cable or an optional HP Camera Dock)
- 3 On the computer, click on **Retrieve from Camera**.
- 4 In the screen called **Modify Share Menu** check to see that **Photo E-mail** is visible above the **Add...** button, then click on the **Add...** button.

- 5 If you are using a Macintosh computer, skip to step 7. If you are using a computer running Windows, you will be asked to sign in to HP's Passport program. HP Passport allows you to use HP's free e-mail service and other services that may be available in the future. The first time you see this screen, you will need to register as a new user. Follow the instructions on the screen for doing that.
- 6 Once you have successfully registered, sign in to the HP Passport program, and then the **Photo E-mail Setup** screen will appear. Here, you can enter an e-mail address and specify how you want it to appear in the camera's **Share** menu. You can also enter a subject and message to go with the e-mail that will be sent to that address. After completing the form, click **Next**. In the confirmation screen that appears, click **Finish**.
- 7 Your newly added e-mail destination should now appear in the **Modify Share Menu** screen (in the **Current Share Menu** section). To add additional e-mail addresses to the camera **Share** menu, repeat steps 4-6. You will not need to sign in to the HP Passport program again.
- 8 When you have finished adding e-mail addresses, click on **Save to Camera** to add the new addresses to the camera **Share** menu. When the computer confirms that the addresses were saved to your camera, disconnect the camera from the computer, and press the **Share**  button to view the new e-mail destinations in the **Share** menu.
- 9 You are now ready to select images on the camera to be e-mailed. See the next section for how to do this.

Selecting images to be e-mailed

- 1 Turn on the camera, then press the **Share**  button.
- 2 Use the **◀ ▶** buttons to scroll to an image you want to e-mail. Video clips cannot be selected for e-mail.

- 3 Press **OK** to activate the **Share** menu, then use the ◀ ▶ buttons to scroll to the e-mail destination that you want to select.
- 4 Press **OK** to select the e-mail destination, and a check mark appears next to that selection. (You can select more than one e-mail destination or print option for an image.)
- 5 Scroll to other images by using the ◀ ▶ buttons and repeat steps 3 and 4 to select e-mail destinations for each image.
- 6 When you are finished selecting all the images you want to e-mail, press the **Share** ⌘ button.
- 7 The next time you connect the camera to your computer, images are unloaded to the computer, and the images selected for e-mail will be sent to their respective destinations.

The way images are e-mailed works differently on Windows and Macintosh computers.

Windows

Images are not e-mailed directly to anyone. Rather, a message is sent to each e-mail address that you selected in the **Share** menu. The message contains a thumbnail of each of the images that were selected for that address, as well as a link to a web page where the recipient can view the images. From that web page, the recipient can do things like reply to you or print the image. This makes it easy for people who use different e-mail programs to be able to see your images without the difficulty of dealing with e-mail attachments.

Macintosh

Images are e-mailed directly to recipients using the default e-mail program on your computer.

5 Unloading, printing, & displaying images

Once you have taken pictures, you can unload them from your camera to a computer, print them directly to a printer, or display them on a television.

Unloading to a computer

NOTE You can also use the optional HP Camera Dock to do this task. See **Appendix B: Camera dock** on page 73.

NOTE If you are using a Macintosh computer, switch the camera to **Disk Drive** in the **USB Configuration** menu found in the **Setup** menu.

- 1 Your camera came with a special USB cable for connecting the camera to a computer. Connect the larger end of that USB cable to the computer.
- 2 Open the memory card door on the side of the camera and connect the small end of the USB cable to the USB connector on the camera.
- 3 Turn on the camera. The HP Image Unload software will launch on your computer, and the images in the camera will automatically unload to the computer. If there were any images in the camera that were selected in the **Share** menu for printing or e-mail, those actions are started after the images have been unloaded to the computer.

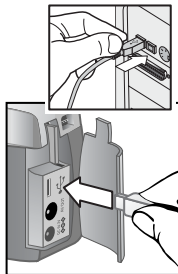

- 4 When the unload screen on the computer says **Finished**, your images have been saved and shared. You can now disconnect the camera from the computer.

NOTE To unload the camera images to a computer that does not have the HP Photo & Imaging software installed on it, switch the camera to **Disk Drive** in the **USB Configuration** menu found in the **Setup** menu. This allows the camera to appear as another disk drive on the computer.

Printing images

NOTE You can also use the optional HP Camera Dock to do this task. See **Appendix B: Camera dock** on page 73.

To print images that have been unloaded to the computer, you can use the HP Photo & Imaging software that was shipped with the camera.

You can also connect the camera directly to any HP DeskJet or Photosmart printer that has a USB connection, then print images selected from the camera **Share** menu or all images in the camera.

- 1 Your camera came with a special USB cable for connecting the camera directly to a printer.
- 2 Connect the square end of the USB cable to the printer.
- 3 Open the memory card door on the side of the camera and connect the small end of the USB cable to the USB connector on the camera.
- 4 Adjust the settings in the **Print Setup** menu on the camera to complete the printing process.

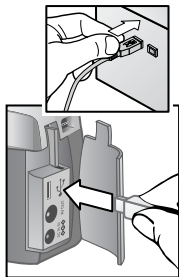

Displaying images on a TV

Images in your camera can easily be displayed as a slideshow on almost any television (TV).

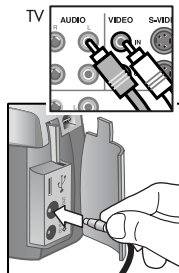

NOTE You can also use the optional HP Camera Dock to do this task. See **Appendix B: Camera dock** on page 73.

- 1 To connect the camera directly to a TV, you must first purchase an A/V (Audio/Video) cable. For details, see **Purchasing accessories** on page 71.
- 2 Connect the A/V cable to the TV connector on your camera and then to the A/V inputs on the TV.
- 3 Refer to the documentation for the TV to determine how to set the TV to take input from your camera instead of the antenna or cable TV.



Displaying a slideshow

Once the camera is connected to the TV with the A/V cable or the optional HP Camera Dock, you are ready to start.

- 1 Turn on the camera. If you are using an A/V cable, the **Slideshow** menu will appear on the camera. If you are using the HP Camera Dock, the  button on the dock should light up. Press the  button, and the **Slideshow** menu will appear on the camera. The options in the **Slideshow** menu are described in the following table

Option	Description
NTSC Television	Used mostly in North America and Japan
PAL Television	Used mostly in Europe and Asia
5 Sec/Image	Displays each image for 5 seconds
10 Sec/Image	Displays each image for 10 seconds
Manual Advance	Waits for you to advance each image using the ◀ ▶ buttons on the camera
Begin	Starts the slideshow

- 2 To change an option, highlight it and press **OK**. Each time **OK** is pressed, the next option is selected. All selections except **Begin** are stored in the camera and become the defaults until changed.
- 3 To start the slideshow, select **Begin**. The camera's Image Display turns off and the slideshow starts on the TV. The slideshow begins with the image last taken or viewed and displays each image in sequence. When the end is reached the sequence moves to the beginning and continues. Audio and video clips are always played to completion, regardless of the rate you specified in the **Slideshow** menu.
- 4 To exit the slideshow, unplug the A/V cable or press the  button on the dock.

At any time during the slideshow, you can press the ◀ ▶ buttons to move forward or backward. Pressing and holding these keys auto repeats similar to **Playback** mode.

NOTE The Main menu and **Share** menu are available during the slideshow. You can rotate, delete, view thumbnails, magnify, share, etc. during the slideshow.

6 Troubleshooting and support

Problems and solutions

Problem	Possible cause	Solution
The camera does not turn on.	The batteries are not functioning correctly or are missing.	Use only photo-quality AA lithium, alkaline, or NiMH batteries. Ensure the batteries are inserted correctly. The charge in the batteries can be low or completely drained. Try installing new or recharged batteries.
	The HP AC adapter is connected to the camera, but it is not connected to a power outlet.	If you want to use battery power, disconnect the HP AC adapter from the camera. If you want to use AC power, connect the HP AC adapter to a working electrical outlet.
The HP AC adapter is not functioning correctly.		Ensure that the HP AC adapter is not damaged or defective and is plugged into an electrical outlet with power.

Problem	Possible cause	Solution
The camera does not respond when I press a button.	The camera is off.	Turn on the camera.
	The camera is connected to a computer.	The camera buttons other than the Power button do not respond when the camera is connected to a computer.
	The batteries are drained.	Replace or recharge the batteries.
	The camera has stopped operating.	Remove and reinsert the batteries. Replace the batteries if necessary.
The camera does not take a picture when I press the Shutter button.	You did not press the Shutter button hard enough.	Press the Shutter button all the way down.
A long delay occurs between the time I press the Shutter button and the camera takes a picture.	The camera needs time to focus and set exposure	Press the Shutter button halfway down to let the camera focus, then when you press all the way down, there is much less delay. See Using focus lock on page 21 for more details.
	The flash is recharging.	Wait until the yellow viewfinder light stops blinking before taking another picture.
	The Self-timer is activated.	Turn the Self-timer off.
	The camera is still saving the last picture you took.	Wait a few seconds for the camera to finish processing the image, and then press the Shutter button.

Problem	Possible cause	Solution
The wrong date and/or time is shown.	The batteries died or were removed from the camera for more than 10 minutes.	Reset the date and time by using the camera menus. See the section called Date & time on page 38.
I replace the camera batteries frequently.	Extended Image Display use and excessive flash use consume a lot of battery power.	Use an HP AC adapter to power the camera when you are using the Image Display for an extended period of time and when you are unloading several images to your computer. Use the flash only when needed. Do not use ordinary alkaline batteries. Purchase higher-grade batteries, such as "ultra" or "premium" grade alkaline or photo-lithium batteries, or switch to rechargeable NiMH batteries.
	The NiMH batteries you are using were recharged incorrectly.	You must recharge all NiMH batteries after fully draining them four times for the batteries to reach their optimum capacity and performance.

Problem	Possible cause	Solution
My image is blurry.	Your subject was too close to the camera lens.	Do not try to get closer than the camera's minimum focus range (see Appendix C: Specifications on page 77).
	You moved the camera while you took the picture.	Hold the camera steady as you press the Shutter button or use a tripod.
	The light is low and the flash is turned off.	In dim light, the camera requires a longer exposure. Use a tripod to hold the camera steady, improve lighting conditions, or use the flash.
My image is too dark.	There was not enough light.	Wait for natural lighting conditions to improve, add indirect lighting, or adjust the EV compensation.
	The flash was on, but the subject was too far away.	Make sure your subject is within the flash working distance (see Appendix C: Specifications on page 77) or try turning flash off (will require longer exposure).
	A light shone behind the subject.	Use the Flash On setting to brighten the subject when there is a bright light such as the sun or a window behind your subject.
	Your finger blocked the flash.	Be sure to move your fingers away from the flash when you take a picture.

Problem	Possible cause	Solution
My image is too bright.	The flash provided too much light.	Change the flash setting to Flash Off .
	A natural or artificial source other than the flash provided too much light.	Try taking the picture from a different angle. Avoid pointing the camera directly toward a bright light or reflective surface on a sunny day. If there is light behind your subject, use the Flash On setting. Adjust the EV compensation.
	You were too close to the subject to use the flash.	Move back from the subject or set the flash to Flash Off and take the picture again.
When I connect the camera to my computer, the software says it cannot find the camera.	The camera is turned off.	Turn on the camera.
	The cable is not connected correctly.	Make sure that the cable is firmly connected at both ends.
	The camera is connected to the computer through a USB hub and your USB hub is not compatible with the camera.	Connect the camera directly to a USB port on the computer.

Problem	Possible cause	Solution
When I connect the camera to a Macintosh computer, I do not get a Disk Drive icon on my desktop.	The USB Configuration setting is not set to Disk Drive.	Change the USB Configuration setting to Disk Drive.

Error messages

You may receive error messages on the camera's Image Display, or on your computer screen.

Error messages on the camera

Message	Possible cause	Solution
BATTERIES DEPLETED Camera is shutting down	Battery power is too low to continue operation.	Replace or recharge batteries, or use an optional HP AC adapter.
Batteries are too low for Preview	Battery power is too low to use Preview mode.	Take pictures with the Image Display turned off. Replace or recharge batteries, or use an optional HP AC adapter.
Batteries are too low to record a video clip.	Battery power is too low to record a video clip.	Replace or recharge batteries, or use an optional HP AC adapter during video recording.

Message	Possible cause	Solution
Unsupported card	The card in the memory slot is not a memory card or is not a supported memory card.	Ensure that the card is the proper type for your camera (see Appendix C: Specifications on page 77).
The card requires formatting	The memory card needs to be formatted.	Press OK to display the Format Card option in the Delete menu. This will delete all data on the card.
The card is locked	The memory card is write-protected.	Unlock the memory card (latch on edge of card) or insert a new card.
The card is too full to move any images	There is insufficient room to move images to the memory card.	Unload images from the memory card to your computer, then delete all images on the memory card.
Invalid date	The date was set incorrectly.	Enter the correct date.
Unsupported image file	You are trying to record audio, magnify, rotate, or print an image file that was not created by this camera.	Use the computer software to manipulate the file.
Memory is too full OR The card is too full	There is insufficient room to rotate an image or to record audio.	Unload the images from the camera or delete unwanted images.

Message	Possible cause	Solution
Unknown USB device	The connected USB device is not a printer.	Disconnect the current USB connection and connect to your printer.
Unsupported printer	The printer is an unsupported device.	Disconnect the USB cable, and connect to a supported printer, such as HP Photosmart or HP Deskjet.
Unable to communicate with printer	The printer has a problem.	Check the printer.
Disengage photo tray	The selected paper size cannot be used with the printer photo tray	Disengage the printer photo tray, or change the paper size.
Printer top cover is open	The printer is open.	Close the top cover of the printer.
Incorrect or missing print cartridge	The printer cartridge is the incorrect model or is missing.	Install a new printer cartridge, turn the printer off, then turn it back on.
Printer has a paper jam.	There is a paper jam or the printer carriage has stalled.	Turn off the printer. Clear the paper jam, and then turn on the printer.

Message	Possible cause	Solution
Printer is out of paper.	Your printer is out of paper.	If OK is visible on the Image Display, load paper and then press OK on the camera. Otherwise, load paper, and then press OK or Continue on your printer.
Printing canceled	The print job has been canceled.	Press the OK button on the camera. Complete the print request again.
Any error code numbers that appear	The camera is having a problem that HP needs to fix	Call HP Support (see Getting assistance on page 60).

Error messages on the computer

Message	Possible cause	Solution
Connection between the imaging device and computer failed	The camera might be connected to a computer through a USB hub.	Try connecting the camera directly to the computer, or disconnect other devices attached to the hub.
The software says it cannot find the connected camera	The camera is not working correctly.	Connect the camera directly to a USB-enabled HP DeskJet or Photosmart printer and print an image. This will verify that the image, memory, USB connection and the USB cable are functioning correctly or identify the failure.

Getting assistance

Finding help on the web

HP product support

Visit www.hp.com/cposupport/loc/regional.html, select your language, and then type your camera model in the “quick find” box to find information about setting up and using your camera, downloading drivers, solving a problem, ordering, and warranty information.

HP photosmart website

Visit www.hp.com/photosmart for tips on using your camera more effectively and creatively as well as HP digital camera driver updates and software.

HP accessibility website

Visit www.hp.com/hpinfo/community/accessibility/prodserv if you have a disability and need help.

Contacting hp customer support

In addition to the Web, you can contact HP by telephone or mail for support and service for your camera. Prices, availability, and hours of support are subject to change without notice.

How hp can help

The HP support hotline can help resolve problems with setup, installation, configuration, and operation. For help with non-HP hardware or software, please contact the manufacturer.

Before you call

Review troubleshooting tips.

Have the following information ready before you call:

- serial number (found on the bottom of your camera)
- product name
- date of purchase

Service is free of charge during the warranty period. Beyond the warranty period, a service fee will be charged.

Obtaining support in the United States

Free telephone support for one year

Within one year of your purchase, telephone support is provided to you free of charge. If this is a long distance call for you, long distance charges will apply.

Call (1) (208) 323-2551.

Our support staff is available from 6 am to 10 pm Mountain Time, Monday through Friday, or 9 am to 4 pm Saturday.

If you think your HP product might need service, call HP Customer Support, which can help determine if service is required. Or, visit www.hp.com/cpsosupport/guide/psd/repairhelp.html for the nearest sales and service office.

After the first year

Call (1) (208) 323-2551.

A fee of \$25.00 per call (U.S.) will be charged to your credit card. Charges begin only when you connect with a support technician.

Upgraded warranty options

You can select one of the following upgraded warranty options (available in the U.S. only):

- Standard Next Day Exchange
- Accidental Damage Protection with Next Day Exchange

Upgrade your standard factory warranty to three years with the HP SupportPack. Service coverage begins on product purchase date and the pack must be purchased within the first 180 days of product purchase. HP will determine the hardware service offering based upon the outcome of system self-test programs run by the customer through the initial call to the HP Customer Care Center. If during your technical support call it is determined that your product needs replacement, HP will ship you this replacement product next business day free of charge. Optional Accidental Damage Protection is also available. This warranty upgrade protects against accidental breakage such as spills, drops, or falls. Both of these warranty upgrades offer maximized uptime and productivity, the convenience of door-to-door pickup with delivery, packaging and freight prepaid by HP.

For more information call 1-888-999-4747 or visit www.homeandoffice.hp.com and select “warranty upgrades” under “product support.”

Obtaining support worldwide

Telephone support is free for one year in Asia and the South Pacific, and for 30 days in the Middle East and Africa.

The information contained in this document and the applicable conditions for HP phone support are subject to change without notice. Please check for the latest information and conditions at www.hp.com/cposupport/loc/regional.html.

Alternatively, you can ask your dealer or call HP at the phone number listed in this document. For English support in Europe, contact +44 (0) 207 512 52 02.

Algeria +213 (0) 61-56-45-43

Argentina 0-810-555-5520

Australia +63 (3) 8877 8000 (or local (03) 8877 8000)

Austria +43 (0) 810-00-6080

Bahrain 800-728

Belgium Dutch: +32 (0)2 626 8806

French: +32 (0)2 626 8807

Brazil (11) 4689-2012 (Grande São Paulo)
0800-157751 (outside Grande São Paulo)

Canada 905-206-4663 (during the warranty period)
877-621-4722 (after the warranty period)

Chile 800 360 999 (Post-sales Home Computing)

China +86 (10) 6564 5959

Colombia 9-800-114-726

Czech Republic +42 (0)2 6130 7310

Denmark +45 39 29 4099

Egypt 02 532 5222

Finland +358 (0)203 47 288

France +33 (0)8 92 69 60 22 (Euro 0.34/minute)

Germany +49 (0)180 52 58 143 (Euro 0.12/minute)

Greece +30 10-60-73-603

Guatemala 1 800 999 5305

Hong Kong SAR +852 3002 8555

Hungary +36 (0)1 382 1111

India 1 600 112267 or +91 11 682 6035

Indonesia +62 (21) 350 3408

Ireland +353 (0)1 662 5525

Israel +972 (0) 9-830-4848

Italy +39 02 264 10350

Japan 0570-000-511 (inside Japan)
+81 3 3335-9800 (outside Japan)

Korea, Republic of +82 (2) 3270 0700 (Seoul)
0-80-999-0700 (outside Seoul)

Malaysia 1-800-805-405

Mexico 52 58 9922 (Mexico City)
01-800-472-6684 (outside Mexico City)

Middle East/Africa +44 (0) 207 512 52 02

Morocco +212 224-04747

Netherlands +31 (0)20 606 8751

New Zealand +64 (9) 356 6640

Norway +47 22 11 6299

Peru 0 800 10111

Philippines +63 (2) 867-3551

Poland +48 22 865 98 00

Portugal +351 21 3176333

Puerto Rico 1 877 232 0589

Romania +40 1 315 44 42 (or local 01 3154442)
Russian Federation +7 095 797 3520 (Moscow)
+7 812 346 7997 (St. Petersburg)
Saudi Arabia 800 897 14440
Singapore +65 6272-5300
Slovakia +421-2-68208080
South Africa 086 000 1030 (RSA)
+27-11 258 9301 (outside RSA)
Spain +34 902 321 123
Sweden +46 (0)8 619 2170
Switzerland +41 (0)848 80 11 11
Taiwan 0 800 01 0055
Thailand +66 (2) 661 4000
Tunisia +216 6272-5300
Turkey +90 216 579 71 71
Ukraine +7 (380-44) 490-3520
United Arab Emirates 971 4 883 8454
United Kingdom (UK) +44 (0) 207 512 52 02
Venezuela 0 800 4746 8368
Viet Nam +84 (0) 8 823 4530

Hewlett-Packard limited warranty statement

The HP photosmart 720 camera comes with a one year limited warranty.

- HP warrants to you, the end-user customer, that HP hardware, accessories, software, and supplies will be free from defects in materials and workmanship after the date of purchase, for the period specified above. If HP receives notice of such defects during the warranty period, HP will, at its option, either repair or replace products which prove to be defective. Replacement products may be either new or equivalent in performance to new.
- HP warrants to you that HP software will not fail to execute its programming instructions after the date of purchase, for the period specified above, due to defects in material and workmanship when properly installed and used. If HP receives notice of such defects during the warranty period, HP will replace software which does not execute its programming instructions due to such defects.
- HP does not warrant that the operation of HP products will be uninterrupted or error free. If HP is unable, within a reasonable time, to repair or replace any product to a condition as warranted, you will be entitled to a refund of the purchase price upon prompt return of the product.
- HP products may contain remanufactured parts equivalent to new in performance or may have been subject to incidental use.
- Warranty does not apply to defects resulting from (a) improper or inadequate maintenance or calibration, (b) software, interfacing, parts or supplies not supplied by HP, (c) unauthorized modification or misuse, (d) operation outside of the published environmental specifications for the product, or (e) improper site preparation or maintenance.
- TO THE EXTENT ALLOWED BY LOCAL LAW, THE ABOVE WARRANTIES ARE EXCLUSIVE AND NO OTHER WARRANTY OR CONDITION, WHETHER WRITTEN OR ORAL, IS EXPRESSED OR IMPLIED AND HP SPECIFICALLY DISCLAIMS ANY IMPLIED WARRANTIES OR CONDITIONS OF MERCHANTABILITY, SATISFACTORY QUALITY, AND FITNESS FOR A PARTICULAR

- PURPOSE. Some countries, states or provinces do not allow limitations on the duration of an implied warranty, so the above limitation or exclusion might not apply to you. This warranty gives you specific legal rights and you might also have other rights that vary from country to country, state to state, or province to province.
- HP's limited warranty is valid in any country or locality where HP has a support presence for this product and where HP has marketed this product. The level of warranty service you receive may vary according to local standards. HP will not alter form, fit or function of the product to make it operate in a country for which it was never intended to function for legal or regulatory reasons.
 - TO THE EXTENT ALLOWED BY LOCAL LAW, THE REMEDIES IN THIS WARRANTY STATEMENT ARE YOUR SOLE AND EXCLUSIVE REMEDIES. EXCEPT AS INDICATED ABOVE, IN NO EVENT WILL HP OR ITS SUPPLIERS BE LIABLE FOR LOSS OF DATA OR FOR DIRECT, SPECIAL, INCIDENTAL, CONSEQUENTIAL (INCLUDING LOST PROFIT OR DATA), OR OTHER DAMAGE, WHETHER BASED IN CONTRACT, TORT, OR OTHERWISE. Some countries, states or provinces do not allow the exclusion or limitation of incidental or consequential damages, so the above limitation or exclusion may not apply to you.
 - THE WARRANTY TERMS CONTAINED IN THIS STATEMENT, EXCEPT TO THE EXTENT LAWFULLY PERMITTED, DO NOT EXCLUDE, RESTRICT OR MODIFY AND ARE IN ADDITION TO THE MANDATORY STATUTORY RIGHTS APPLICABLE TO THE SALE OF THIS PRODUCT TO YOU.

Regulatory information



For regulatory information, see the [regulatory_supplement.htm](#) file on the software CD that came with your camera.

Appendix A: Batteries and accessories

Managing batteries

When the batteries are removed from the camera, the date and time settings are preserved for approximately 10 minutes. If the camera is without batteries for longer than 10 minutes, the clock is set to the last time and date at which the camera was used. You may be prompted to update the date and time.

The following battery levels are displayed on the Status LCD and the Image Display.

Icon	Level	Description
	Full	Batteries have 30 – 100 percent remaining
	Partially full	Batteries have 10 – 30 percent remaining
	Empty	Batteries have less than 10 percent remaining
None	N/A	Camera is operating on AC power

The camera uses four AA batteries. Acceptable batteries include photo-lithium, “ultra” or “premium” grade alkaline, or rechargeable NiMH. For the best results with your camera, use photo-lithium or NiMH batteries.

NOTE If you do not intend to use your camera for extended periods of time (more than a month), we strongly recommend that you remove the batteries from the camera.

Extending battery life

- Use an optional HP AC adapter or HP Camera Dock when unloading pictures to your computer, printing, or connecting to the TV.
- Use the optical viewfinder to frame pictures instead of the Image Display. Leave the Image Display off when the camera is on.
- Turn the camera off during a pause in picture taking.
- Use the **Auto Flash** setting rather than **Flash On** or **Red-eye Reduction**.

Rechargeable batteries

Nickel Metal Hydride (NiMH) batteries can be recharged by using a battery charger, the HP Camera Dock, or in the camera when it is connected to the AC adapter. Some things to keep in mind when using NiMH batteries are:

- Always recharge all four NiMH batteries at the same time. One low-charged battery will reduce the battery life for all four batteries in the camera.
- For NiMH batteries to reach optimal capacity and performance, they should first be discharged completely and recharged four separate times.
- After long-term storage of NiMH batteries, recharge them before using them again. Battery cells generally discharge at about 1 percent per day at room temperature.

Power conservation

To conserve battery power, the Image Display turns off automatically if there is no button activity for 60 seconds. If no buttons are pressed for 10 minutes, the camera turns off (unless it is printing or connected to a computer or TV).

Purchasing accessories

You can purchase additional accessories for your camera from your local retailer or online at www.hpshopping.com. Some accessories for the HP photosmart 720 digital camera are listed below:

- HP AC power adapter (HP Supports only HP AC adapters and other accessories expressly approved by HP)
 - North America—C8875A #001
 - Outside of North America—C8875A #002
- HP Photosmart 8881 Camera Dock
- Secure digital (SD) memory card only (128 MB is the maximum usable card size)
- HP audio/video accessory cable (C6324-61601) to connect to a television.

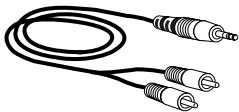

Note: You can also use any Y-adapter audio cable with dual RCA plugs on one end and a 1/8 inch (3.175 mm) mini-stereo jack on the other end. You will also need an adapter plug that accepts a 1/8 inch (3.175 mm) jack and fits into a 3/32 inch (2.38 mm) phone jack.

- HP Digital Camera Accessory Kit (Y1788 for United States, Y1789 for outside the United States). Contents include:
 - Camera bag
 - Rechargeable NiMH batteries
 - Battery charger
- HP Digital Camera Accessory Kit (C8884A). Contents include:
 - Camera bag
 - Rechargeable NiMH batteries
 - Battery charger
 - 32 MB SD memory card
 - Tripod



Appendix B: Camera dock

NOTE The HP Camera Dock does not work without AC power. Be sure to use **ONLY** the HP AC adapter and the cables that came with the Camera Dock.

- 1 Follow the setup instructions provided with the Camera Dock. This includes installing the Dock Insert onto the dock, installing rechargeable batteries in the camera, connecting the AC power source, and connecting the Camera Dock to a computer, printer, and/or television.
- 2 Make sure your camera is set up correctly and remove any cables that may be attached to it before putting it in the dock.
- 3 Place the camera in the Camera Dock with the rear of the camera facing the front of the Camera Dock.



The Camera Dock has three I/O connectors on the back:

-  —Connects to the television
-  —Connects directly to HP USB DeskJet and Photosmart printers
-  —Connects to your computer





There is a sliding door over the computer and printer connectors that prevents you from using both connectors at the same time (the Camera Dock is not a USB hub).

The Camera Dock has a light near the top front that provides battery charging status. A blinking light indicates that batteries are charging.

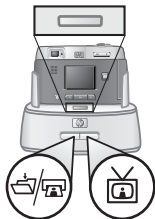
There are two buttons on the front that light up, showing the camera is connected to the associated device.



 — This button activates the connection to the computer or the printer, depending on which of those devices is connected to the dock.

 — This button activates the television connection.

The functions of the dock button lights are described below:

State	Indication
On	Camera Dock has power and a device is connected. When you press a button for one device, the other button device light goes out.
Blinking	The associated device is active.
Off	<ul style="list-style-type: none">• The associated device is not connected to the Camera Dock.• The associated device is not available because the other device is active.• Camera Dock has no power or there is no camera connected.

Unloading images to a computer using the dock

NOTE If you are using a Macintosh computer, switch the camera to **Disk Drive** in the **USB Configuration** menu found in the **Setup** menu.

- 1 Check that the HP Camera Dock is connected to your computer.
- 2 Place the camera in the Camera Dock. It will turn on automatically, and a dock intro screen will appear.
- 3 Press the  button on the dock to start the unload process. The **HP Image Unload** software will launch on your computer, and the images in the camera will automatically unload to the computer. If there were any images on the camera that had been selected in the **Share** menu for printing or e-mail, those actions are started after the images have been unloaded to the computer.
- 4 The camera will return to the dock intro screen when your images have been saved and shared. You can now take the camera out of the dock, or leave it there to recharge the camera batteries.

Printing images using the dock

- 1 Check that the HP Camera Dock is connected to your printer. (The dock cannot be connected directly to both a computer and a printer at the same time).
- 2 Place the camera in the Camera Dock. It will turn on automatically, and a dock intro screen will appear.
- 3 Press the  button on the dock to start printing.
- 4 Adjust the settings in the **Print Setup** menu on the camera to complete the printing process.
- 5 The camera will return to the dock intro screen when printing is complete. You can now take the camera out of the dock, or leave it there to recharge the camera batteries.

Displaying images on a TV using the dock

- 1 Check that the HP Camera Dock is connected to your TV.
- 2 Refer to the documentation for your TV to determine how to set the TV to take video input from your camera instead of the antenna or cable TV.
- 3 Place the camera in the dock. It will turn on automatically, and a dock intro screen will appear.
- 4 Press the  button on the dock, and the **Slideshow** menu will appear on the camera's Image Display.

The rest of this procedure is described in the section **Displaying a slideshow** on page 49.

Appendix C: Specifications

Feature	Description																
Resolution	3.15 MP (2048 by 1536 effective pixel count) 3.34 MP (2140 by 1560 total pixel count)																
Sensor	Diagonal 8.933 mm (Type 1/1.8) CCD																
Color depth	30-bit (10 colors by 3 colors)																
Capture types	Still, Self-timer, Burst, and Video																
Memory	16 MB internal memory Slot for a Secure Digital (SD) memory card (not MMC card)																
Still image capacity (for 16 MB of memory)	<table border="1"> <thead> <tr> <th>Image Quality</th> <th>Approx. # Images</th> <th>File Size</th> <th>Resolution</th> </tr> </thead> <tbody> <tr> <td>★</td> <td>220</td> <td>60 KB</td> <td>640 by 480</td> </tr> <tr> <td>★★</td> <td>18</td> <td>800 KB</td> <td>2048 by 1536</td> </tr> <tr> <td>★★★</td> <td>11</td> <td>1200 KB</td> <td>2048 by 1536</td> </tr> </tbody> </table>	Image Quality	Approx. # Images	File Size	Resolution	★	220	60 KB	640 by 480	★★	18	800 KB	2048 by 1536	★★★	11	1200 KB	2048 by 1536
Image Quality	Approx. # Images	File Size	Resolution														
★	220	60 KB	640 by 480														
★★	18	800 KB	2048 by 1536														
★★★	11	1200 KB	2048 by 1536														
Lens	<p><i>Focal length</i></p> <ul style="list-style-type: none"> • Wide – 7 mm • Telephoto – 21 mm <p><i>F-Number</i></p> <ul style="list-style-type: none"> • Wide – f/2.6 and f/5.9 • Telephoto – f/4.8 and f/10.0 																
Viewfinder	Zooming optical viewfinder																

Feature	Description
Zoom	3x optical, 4x digital zoom 7 mm to 21 mm (35 mm equivalent is approximately 34 mm to 102 mm)
Focus	TTL auto focus Wide: 20 cm to infinity Telephoto: 20 cm to infinity
Shutter speed	1/1000 to 2 seconds
Flash settings	Auto, Red-eye Reduction, Flash On, Flash Off
Flash working distances	Wide zoom—3.6 m Telephoto zoom—2.0 m
Exposure control	Automatic exposure (default) Can be set manually from -1.5 to +1.5 in 0.5 increments
ISO (Sensitivity)	Automatic (default) Can be set manually to 100, 200, and 400
Metering	Average
White Balance	Automatic (default) Can be set manually to Daylight (5000K), Cloudy (6500K), Tungsten (2600K), Fluorescent 1 (6000K), and Fluorescent 2 (3600K)
Image Display LCD	Color LED Backlit, 1.6 inches (4.1 cm) polysilicon TFT LCD
Status LCD	10 mm by 25 mm viewable area
Self-Timer	10 second delay

Feature	Description
Audio capture	<p><i>Still pictures</i> Up to 4:00 minutes of audio annotation can be added to each still picture (limited by available memory)</p> <p><i>Video</i> Audio captured automatically with video</p>
Compressed format	<p>JPEG (EXIF) for still images Motion JPEG for video clips</p>
Power	<p>4 AA batteries (included)</p> <p>Optional HP AC adapter (6V, 2000 mA) C8875A #001 - North America C8875A #002 - outside of North America</p> <p>Slow trickle recharging in camera with optional HP AC adapter or HP Camera Dock (100% in 15 hours)</p> <p>Automatic advanced power management</p> <p>The camera has a maximum power consumption of 5 watts (1.2 amps)</p>
Interfaces	<ul style="list-style-type: none"> ● USB to a computer or USB to HP DeskJet and Photosmart printers ● Audio/Video out to TV ● DC IN 6V ● HP Camera Dock

Feature	Description
Standards	<ul style="list-style-type: none"> ● PTP transfer (15740) ● MSDC transfer ● NTSC/PAL ● JPEG ● Motion JPEG ● DPOF-1 ● EXIF ● DCF
Tripod mount	Yes
Dimensions	<p>External Body Dimensions: 118 mm (L) by 52 mm (W) by 75 mm (H)</p> <p>With lens fully extended: 118 mm (L) by 80 mm (W) by 75 mm (H)</p>
Weight	255 grams without batteries
Warranty	HP 1 year exchange warranty

Index

A

- AA batteries 69
- AC power adapter
 - connector 10
 - HP part number 71, 79
- accessories for camera 71
- alkaline batteries 69
- arrow buttons 10
- audio clips, record 12
- audio clips, record 23, 33
- audio/video
 - cable 71
 - connector 10, 49
- Auto Flash
 - setting 26
 - status icon 14

B

- batteries
 - condition icons 69
 - condition status icon 14
 - door on camera 12
 - extend life 70
 - install 15
 - rechargeable 70
 - types to use 69
 - view levels of life 69
- Best quality setting
 - description 27
 - resolution 77
- Better quality setting
 - description 27
 - resolution 77
- blinking lights

- on camera 11, 21
- on dock 74
- bonus software 18, 19
- burst
 - button 13
 - status icon 14
 - take pictures with 24
- buttons
 - on camera 10
 - on Camera Dock 74

C

- Camera Dock. See HP Camera Dock
- compression format 79
- computer
 - connect camera to 47
 - connect dock to 73
- connections
 - as a USB Mass Storage Device Class (MSDC) 39
 - to Camera Dock 73
 - to computer 47
 - to printer 48
 - to TV 49
 - USB 39
- connectors
 - audio/video 10, 49
 - HP Camera Dock 12, 73
 - power adapter 10
 - TV 10
 - USB 10
- customer support 60

D

- date and time
 - change 38
 - set 17
- delete
 - images and files 32
 - images during Instant Review 22
 - video clips during Instant Review 22
- Digital Print Order Format 43
- digital zoom 25
- disk drive, connect as 39
- Display button 10
- dock. *See* HP Camera Dock
- DPOF 43

E

- e-mail
 - addresses, customizing the Share menu 44
 - images using HP Instant Share 41
- empty batteries, icon 69
- enlarge view of images 34
- error messages
 - on camera 56
 - on computer 59
- exposure compensation, setting 36
- exposure settings 36

F

- files
 - compression formats 77
 - delete on memory card 32
 - DPOF 43
 - size versus quality 27, 77

flash

- button 13
- light 12
- range 78
- settings 26
- Flash Off
 - setting 26
 - status icon 14
- Flash On
 - setting 26
 - status icon 14
- focus
 - lock 21
 - range 78
- format memory 32
- full batteries, icon 69

G

- Good quality setting
 - description 27
 - resolution 77

H

- help from customer support 60
- HP Camera Dock
 - buttons 74
 - connect to 12, 73
 - description 9
 - display to TV 76
 - Dock Insert 9, 73
 - printing from 76
 - unload images 75
- HP Instant Share
 - button 11
 - description 9, 41
 - turn on/off 11
- HP web sites 60

I

- Image Display 11
- image quality
 - button 13
 - status icon 14
- images
 - delete 32
 - magnify view in camera 34
 - move from internal memory to card 40
 - quality settings 27, 77
 - remaining in camera 14, 23
 - rotate 32
 - thumbnails 34
 - unloading camera to
 - computer 47
 - unloading using Camera Dock
 - 75
 - view 29
- install
 - batteries 15
 - bonus software 18, 19
 - Camera Dock 9
 - memory card 16
 - software 18
- Instant Share. *See* HP Instant Share
- internal memory, move images to memory card 40
- ISO, setting 37

L

- language
 - change 40
 - choose at startup 17
- LEDs (lights) on camera
 - description 10
- life of batteries, view 69

lights

- on camera, blinking 11, 21
- on dock, blinking 74
- lock focus 21

M

- Macintosh computer
 - bonus software 19
 - connect to 47, 75
 - install software 19
 - USB setting on camera 39
- magnify view of images 34
- Main menu 31
 - on/off button 11
- memory card
 - capacity 77
 - delete files 32
 - door 10
 - install 16
 - move images to 40
 - slot 10
 - status icon 14
- menu, Main 31
- messages
 - on camera 56
 - on computer 59
- microphone 12
- mount for tripod 12
- move images to memory card 40

N

- NiMH batteries 69
- NTSC video format 50
- number of images remaining 23
- number of images remaining,
 - status icon 14

O

- OK button 11
- optical viewfinder 11
- optical zoom 25

P

- PAL video format 50
- photo-lithium batteries 69
- Picture Transfer Protocol 39
- pictures
 - instant review 22
 - review 29
 - share 41
 - take 21
 - thumbnails 34
- play video clips 29
- Playback mode 29
- power
 - adapter 10
 - battery level icons 69
 - button 13
 - specifications 79
 - turn on/off 16
- Preview mode 23
- print images
 - directly from camera 48
 - from computer 48
 - using Camera Dock 76
 - using HP Instant Share 41
- printer
 - connect dock to 73
 - connect to camera 48
- problems
 - troubleshooting 51
- PTP 39

Q

- quality button 13

- quality levels
 - description 27, 77

R

- range
 - flash 78
 - focus 78
- rechargeable batteries 70
- record
 - audio clips 23, 33
 - video clips 22
- record audio clips 12
- recycling information 3
- Red-eye Reduction
 - setting 26
 - status icon 14
- review pictures 22
- rotate images 32

S

- SD card status icon 14
- self-timer
 - button 13
 - light 12
 - status icon 14
 - take pictures with 24
- Setup menu 35
- Share button 11
- Share menu
 - customize 44
 - description 42
 - e-mail service 44
 - printing options 43
- share pictures 41
- shutter button
 - description 13
 - speed 78

- slideshow
 - display on TV 49
 - menu 50
- software
 - bonus 18, 19
 - install 18
- speaker 11
- specifications 77
- status LCD
 - icons 14
 - location 13

T

- thumbnail images, view 34
- time and date
 - change 38
 - set 17
- tripod mount 12
- troubleshoot problems 51
- turn on/off
 - camera power 13, 16
 - HP Instant Share 11
 - Main menu 11
 - Preview mode 10, 23

TV

- button, Camera Dock 74
- cable to connect camera 71
- configuration setting 50
- connect camera to 49
- connect dock to 73, 76
- connector 10

U

- unloading images
 - camera to computer 47
 - using Camera Dock 75

USB

- change configuration 39
- connector, camera 10
- connector, Camera Dock 73

V

- video
 - button 13
 - light 12
 - recording status icon 14
- video clips
 - play 29
 - record 22
- view
 - battery life level 69
 - camera status icons 14
 - images in camera 29
 - magnified images 34
 - thumbnail images 34
- viewfinder 11
- viewfinder light, description 11

W

- warranty 66
- warranty upgrade options 62
- Web sites for HP 60
- welcome screen, customize 38
- white balance, setting 37
- Windows computer
 - bonus software 18
 - install software 18
- wrist strap
 - mount points on camera 12
 - procedure for attaching 15

Z

zoom

button 11

specifications 78

use optical or digital 25

www.hp.com/photosmart

Printed in Singapore 2002



i n v e n t



Q2164-90010