



Installation/Operation Instructions



General Information

Please read these instructions and keep them in a safe place. These instructions must be followed carefully to ensure proper operation.

The TTA-SIM must be installed in an ordinary (non-hazardous) location. It may be used with any TraceTek sensing cable, point sensor and/or normally open, dry contact devices (float switch, pressure or vacuum switch, optical probe with adapter, limit switch, etc.). Up to 150 m (500 ft) of sensing cable can be monitored by the TTA-SIM. Contact factory for information regarding longer monitoring distance.

An external disconnect device and appropriate branch circuit protection (no more than 20 amp rating) should be provided for the TTA-SIM. The disconnect device should be clearly marked as such. Follow all national and local codes and regulations applicable to the installation.

Installation Items (not supplied)

- Wall fasteners for surface mounting (four screws)
- TT-RS485 telemetry cable (optional)

Tools Required

- Drill for making conduit / cable gland entries
- Phillips (cross-head) screwdriver
- Small flat-blade screwdriver
- Small needle nose pliers (required only for device programming if digital communication is used)
- Tools to mount enclosure

Storage

Keep the TTA-SIM modules in a dry place prior to installation. Avoid damage to components.

Product Information

TTA-SIM-1A-120 & TTA-SIM-2-120	96 to 132 Vac, 50/60 Hz, 3 W
TTA-SIM-1A-230 & TTA-SIM-2-230	216 to 253 Vac, 50/60 Hz, 3 W
Relay contacts	Form C (SPDT), 250 Vac/30 Vdc at 2 Amps maximum
Installation categories	Overvoltage Category II Pollution Degree 2
Storage temperature	-18°C to 60°C (0°F to 140°F)
Operating temperature	0°C to 50°C (32°F to 122°F)
Enclosure	NEMA 1; IP20

Additional Items

An agency-approved zener barrier must be used where sensing cable connected to the TTA-SIM will be located in Class1 Div 1 (Zone 0 or 1 in Europe) Hazardous Locations.

Installing the TTA-SIM

Note: To avoid damage to the TTA-SIM, store the unit in its packaging until ready to install.

Selecting the mounting position

Choose a location where the module will be protected from the elements, temperature extremes or heavy vibration. The TTA-SIM is designed to be wall mounted at any location as long as it does not create a tripping hazard or expose the TTA-SIM to impact damage.

Mounting the TTA-SIM

- Plan cable/conduit alignment and drill holes as necessary. Cable entries should all be located in the open space at the right hand of the TTA-SIM (see Figure 2). A typical installation will require holes to accommodate the following cabling:
 - Incoming power supply
 - TraceTek sensor leadwire
 - [optional] telemetry cable (for RS-485 communication)
 - [optional] cable for relay contacts to remote alarm
- Secure the TTA-SIM enclosure to any convenient vertical surface using the four corner mounting holes and hardware suitable for the selected surface.
- Rough-in conduit as required and pull the cables for power and telemetry. Leave approximately 20 cm (8 in) for connection to TTSIM terminals. Pull in the sensor circuit leader cable.

Note: Rough-in and final connections do not have to be completed at the same time, however, make sure to replace the cover and tighten the cover screws if the enclosure will be left in a partially installed condition overnight or longer.

Power Supply Options

The TTA-SIM has two power supply options available. Depending on the version being installed and local regulations, the wiring requirements may vary. In all cases, be sure that each TTA-SIM receives supply voltage from one and only one source.

Important: Power supply voltage must be within range specified on TTA-SIM label (located on inside of enclosure cover; the information is also located on TTSIM top label).

Connections for Power

Power and ground (earth) connections to the TTA-SIM are made using the large cage-clamp power terminal blocks at the right end of the DIN rail as shown in Figure 3. Cut back the power wires to fit and strip to expose approximately 6 mm (1/4 in) of conductor. Push the tip of a small flat-blade screwdriver into the cage clamp actuator to open the terminal, then insert the wire into the terminal and release the clamp by removing the screwdriver.

Note: In order to provide maximum electrostatic discharge protection, and to be CE compliant, the TTA-SIM must be grounded.

Important: The TTA-SIM is an electronic unit. Take the following precautions to avoid damage to electronic components:

- Handle with care and avoid mechanical shock and impact
- Keep dry
- Avoid exposure to static electricity
- Avoid contact with metal filings, grease, pipe dope and other contaminants

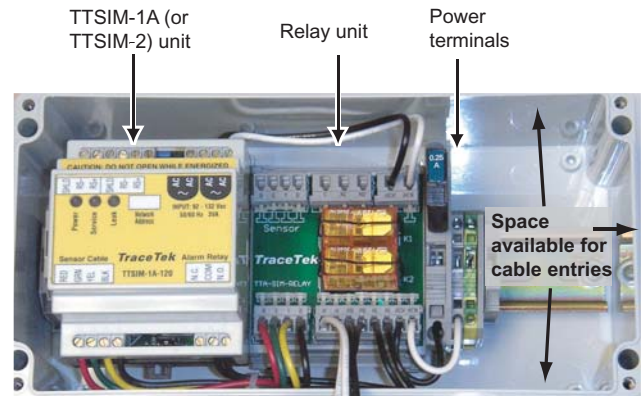

Figure 2. Cable entry locations

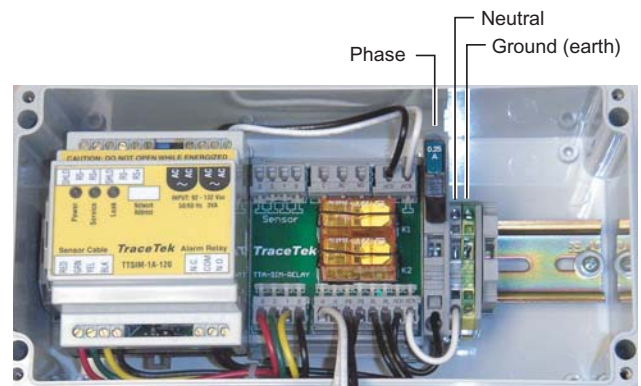

Figure 3. Power connections

Leader Cable Connections for Sensor

The TTA-SIM can be used with any of the TraceTek family of sensing cables including TT1000, TT3000, TT5000 and TT5001, as well as float switches and point probes. Connect the TraceTek leader cable to the lever operated sensor terminals on the relay unit as shown in Figure 4 and the following table.

Note: To connect a wire to a lever operated terminal, use a small flat-blade screwdriver to press down on the lever. Insert the wire (stripped approx. 6 mm [0.25"]) into the opening in the terminal block, then release the lever.

Terminal	Color	Item
R	Red	Red / Green Sensor Cable Loop
G	Green	
Y	Yellow	Yellow / Black Sensor Cable Loop
B	Black	

Connections for Alarm Relay (Optional)

Connections to the TTA-SIM relay are made using the lever operated cage-clamp terminals located on the relay unit (see Figure 5). The software programmable TTA-SIM relay contacts may be used for local or remote annunciation, to control a valve or other device, or for connection to a control automation system contact input. The relay can be programmed to alarm on leak only or on either leak or sensor fault. The relay can also be programmed to be ON (coil energized) or OFF (coil de-energized) to signal an alarm (see table below). The relay can be programmed using a TTDM-128 (see TTDM-128 User Manual).

Programmed Alarm State	Alarm Condition	Status at Terminals	
		10-11	11-12
On (default)	No alarms	closed	open
	Alarm	open	closed
	Loss of power	closed	open
Off	No alarms	open	closed
	Alarm	closed	open
	Loss of power	closed	open

Connections for Telemetry (Optional)

Telemetry connections to the TTA-SIM are made using the screw terminals on the TTSIM unit itself (see Figure 6). Cut back the wires to fit and strip to expose approximately 6 mm (1/4 in) of conductor and make the connections. Be sure to connect the shield as indicated.

Terminal	Color	Item	
13	—	Shield Drain Wire	<i>Shielded twisted pair from Host or previous TraceTek module</i>
14	Black	RS-485 (-)	
15	Red	RS-485 (+)	
16	—	Shield Drain Wire	<i>Shielded twisted pair to next TraceTek module</i>
17	Black	RS-485 (-)	
18	Red	RS-485 (+)	

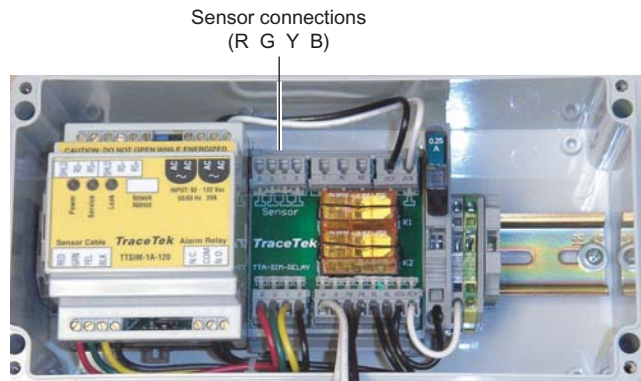

Figure 4. Sensor Connections

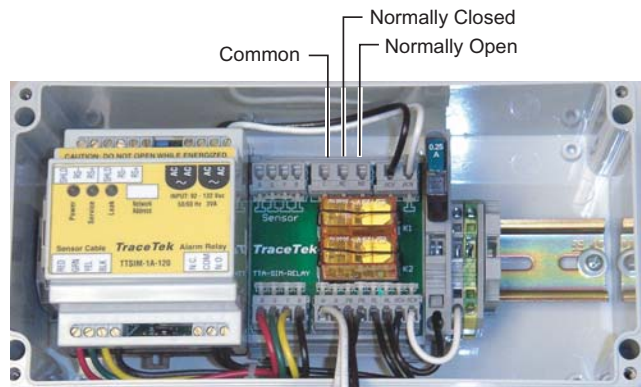

Figure 5. Alarm Relay Connections



Figure 6. Telemetry Connections

Communications setup

Note: This section can be skipped if serial communication is not being used.

If the TTA-SIM will be connected to a TTDM or other host system using RS-485 serial communication, the end of line (EOL) jumper and network address must be set.

Place the End of Line Jumper in the correct position

The End of Line Jumper on the TTSIM-1A or TTSIM-2 unit must be set in the correct position as follows (use a small needle nose pliers to grasp the jumper):

- On the last TTA-SIM in the network communication circuit, place the jumper on the two pins closest to the EOL mark as shown in Figure 7(a).
- On all other TTA-SIMs or TTSIMs in the network, place the jumper as shown in Figure 7(b).

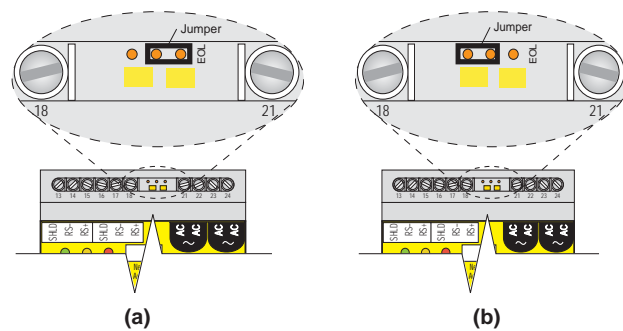

Figure 7. End of Line Jumper for last TTSIM (a) and all other TTSIMs (b)

Network Address Assignment

When used in a communication network, each TTA-SIM module must have a unique address assigned to it in the range 001 to 127. All TTA-SIM units are shipped from the factory with their network address pre-set to a value above the range of valid addresses, in order to prevent communication conflicts during system startup and configuration. Each TTA-SIM must therefore be configured to a unique address before it can communicate with the TTDM-128 or other host.

To set the TTA-SIM network address, repeat the following procedure for each TTA-SIM. Perform the complete procedure one module at a time:

- Using a small needle nose pliers, place the TTA-SIM configuration jumper in the CFG position, as shown in Figure 8(a).
- Using the TTDM-128 or host system, assign the new TTA-SIM address (refer to the TTDM-128 User Manual or the TraceTek System Integration Manual for instructions).
- Place the configuration jumper in the normal operating position, as shown in Figure 7(b), or remove it completely (the jumper is not required in normal operation).

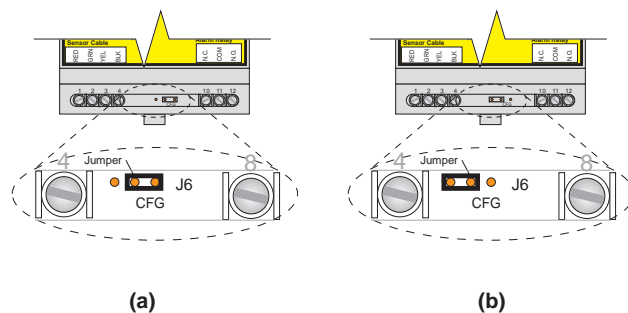

Figure 8. CFG jumper position for configuration mode (a) and normal operation (b)

Operating Instructions: TTA-SIM-1A

No user maintenance is required! There are no user adjustments or calibrations that can be performed in the field.

Each TTA-SIM is tested and calibrated at the factory. An operating TTA-SIM runs a continuous self check routine and reports any discrepancies to the TTDM-128 or host computer. If the TTA-SIM or the network wiring fails in such a way that the TTA-SIM cannot communicate with the host, then the host reports the failure as a communications failure.

Status Indicators

There are 5 LED's on the TTA-SIM-1A circuit board to indicate: power, communications (inbound and outbound), sensor status (leak detected and trouble). See Figure 9.

The green Power LED will be ON and will blink once every 5 seconds when the TTA-SIM is powered and functioning correctly. Table 1 lists various sensor status conditions and possible corrective actions. Table 2 lists communication status conditions (applicable when the TTA-SIM is used in a network system).

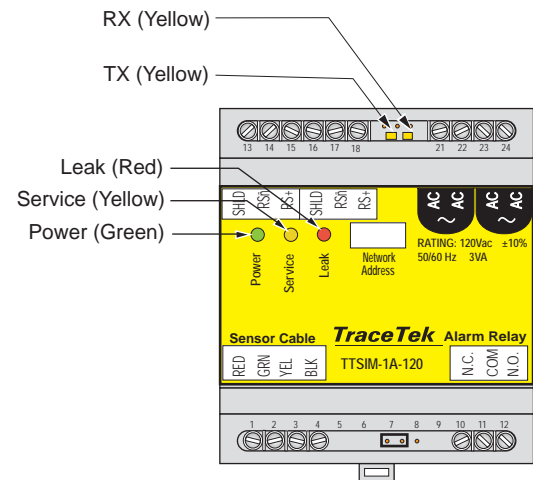

Figure 9. TTA-SIM-1A LED positions (all LEDs are located on the TTSIM unit)

Table 1. TTA-SIM-1A LED operational status indications

LEAK	SERVICE	INDICATION
FLASH		Leak detected. Check sensor for leak or spill.
ON		Leak alarm has been reset by operator but the leak condition still exists
	FLASH	The sensor needs servicing. Check sensor and leadwires/jumpers for continuity or contamination.

Table 2. TTA-SIM communication status indications (only active if connected to a network)

TX	RX	INDICATION
FLASH	FLASH	Unit is communicating normally with TTDM-128 or host.
OFF	FLASH	Unit is receiving communication from TTDM-128 or host, but is not responding.
OFF	ON	RS-485 communication wires are reversed
OFF	OFF	Unit is not communicating with TTDM-128 or host.

Operating Instructions: TTA-SIM-2

No user maintenance is required! There are no user adjustments or calibrations that can be performed in the field.

Each TTA-SIM is tested and calibrated at the factory. An operating TTA-SIM runs a continuous self check routine and reports any discrepancies to the TTDM-128 or host computer. If the TTA-SIM or the network wiring fails in such a way that the TTA-SIM cannot communicate with the host, then the host reports the failure as a communications failure.

Status Indicators

There are 5 LEDs on the TTA-SIM-2 to indicate: power, communications (RX=inbound and TX=outbound), sensor status (leak detected and trouble). There is also a Reset pushbutton which is used to acknowledge or reset alarms or for updating the location display. See Figure 10 for the location of the LEDs and RESET pushbutton.

The green Power LED will be ON and will blink once every 5 seconds when the TTA-SIM-2 is powered and functioning correctly. Table 3 lists various sensor status conditions and possible corrective actions. Table 4 lists communication status conditions (applicable when the TTA-SIM is used in a network system).

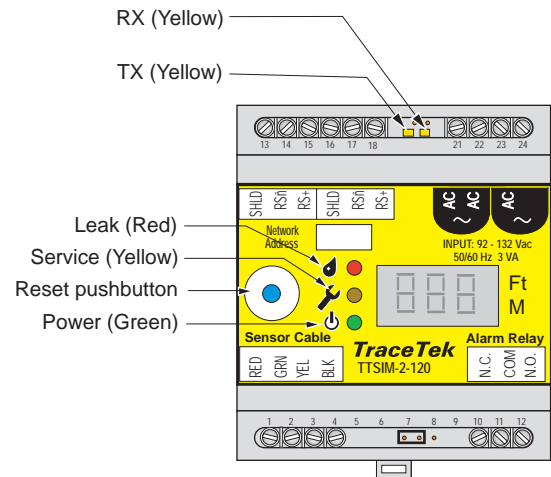

Figure 10. TTA-SIM-2 LED positions (all LEDs are located on the TTSIM unit)

Table 3. TTA-SIM-2 LED operational status indications

LEAK	SERVICE	INDICATION	USER ACTION
FLASH		Leak detected. Check sensor for leak or spill.	Preset reset to acknowledge
ON		Leak alarm has been reset by operator but the leak condition still exists	Press reset to clear alarm once leak is cleaned up
	FLASH	The sensor needs servicing. Check sensor and leadwires/jumpers for continuity or contamination.	Press reset to clear once problem is corrected

Table 4. TTA-SIM communication status indications (only active if connected to a network)

TX	RX	INDICATION
FLASH	FLASH	Unit is communicating normally with TTDM-128 or host.
OFF	FLASH	Unit is receiving communication from TTDM-128 or host, but is not responding.
OFF	ON	RS-485 communication wires are reversed
OFF	OFF	Unit is not communicating with TTDM-128 or host.

Selecting location measurement units

The TTA-SIM-2 can be configured to display leak location in either feet or meters. To select the desired units:

- Press the RESET button and hold it for approximately 3 seconds, until the display shows "Unt".
- A small vertical bar in the LCD will appear next to either the Ft or M label. Press (but do not hold) the RESET button to select the desired units. When the vertical bar is next to the desired units, press and hold the RESET for 3 seconds to accept the setting and return to normal operation,

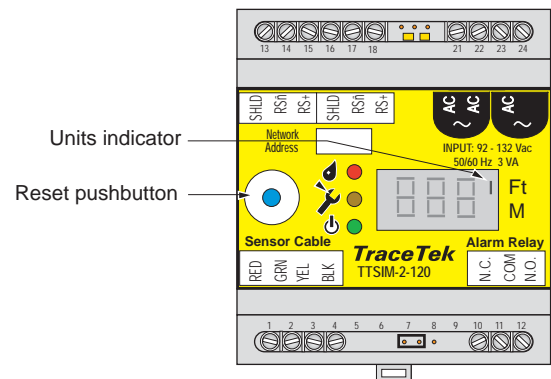

Figure 11. RESET pushbutton and units indicator locations

Tyco Thermal Controls
Worldwide Headquarters
300 Constitution Drive
Menlo Park, CA 94025-1164
USA

Tel: (800) 545-6258 (within US)
(650) 216-1526

Fax: (800) 527-5703 (within US)
(650) 474-7517

E-mail: info@tycothermal.com
www.tycothermal.com

Important: All information, including illustrations, is believed to be reliable. Users, however, should independently evaluate the suitability of each product for their particular application. Tyco Thermal Controls makes no warranty as to the accuracy or completeness of the information, and disclaims any liability regarding its use. Tyco Thermal Controls' only obligations are those in the Tyco Thermal Controls Standard Terms and Conditions of Sale for this product, and in no case will Tyco Thermal Controls or its distributors be liable for any incidental, indirect, or consequential damages arising from the sale, resale, use or misuse of the product. Specifications are subject to change without notice. In addition, Tyco Thermal Controls reserves the right to make changes – without notification to Buyer – to processing or materials that do not affect compliance with any applicable specification.

Tyco, TraceTek and the TraceTek logo are trademarks or registered trademarks of Tyco Thermal Controls LLC or its affiliates.

MODBUS is a trademark of Gould, Inc. OptoMux is a trademark of Opto-22. Metasys is a trademark of Johnson Controls.