

BLUETOOTH 3-SPEED STEREO TURNTABLE 3 CD CHANGER MUSIC SYSTEM WITH DUAL CASSETTE DECK



USER MANUAL JMC-1250



PLEASE READ THIS USER MANUAL COMPLETELY BEFORE OPERATING THIS UNIT AND RETAIN THIS BOOKLET FOR FUTURE REFERENCE.

WARNING

TO PREVENT FIRE OR SHOCK HAZARD, DO NOT USE THIS PLUG WITH AN EXTENSION CORD, RECEPTACLE OR OTHER OUTLET UNLESS THE BLADES CAN BE FULLY INSERTED TO PREVENT BLADE EXPOSURE. TO PREVENT FIRE OR SHOCK HAZARD, DO NOT EXPOSE THIS APPLIANCE TO RAIN OR MOISTURE.

Three warning icons: lightning bolt, CAUTION RISK OF ELECTRIC SHOCK DO NOT OPEN, and exclamation mark. Each icon has a detailed text explanation below it.

The Caution Marking is located at the back enclosure of the apparatus. The Rating plate is located at the back enclosure of the apparatus

IMPORTANT SAFETY INSTRUCTIONS

- 1. Read these instructions.
2. Keep these instructions.
3. Heed all warnings.
4. Follow all instructions.
5. Do not use this apparatus near water.
6. Clean only with dry cloth.
7. Do not block any ventilation openings.
8. Do not install near any heat sources.
9. Do not defeat the safety purpose of the polarized or grounding-type plug.
10. Protect the power cord from being walked on or pinched.
11. Only use attachments/accessories specified by the manufacturer.
12. Use only with a cart, stand, tripod, bracket, or table recommended by the manufacturer.
13. Unplug this apparatus during lightning storms or when unused for a long periods of time.
14. Refer all servicing to qualified service personnel.
15. This appliance shall not be exposed to dripping or splashing water and that no object filled with liquids such as vases shall be placed on the apparatus.



16. Do not overload wall outlet. Use only power source as indicated.
17. Use replacement part as specified by the manufacturer.
18. Upon completion of any service or repairs to this product, ask the service technician to perform safety checks.
19. Power Sources - This product should be operated only from the type of power source indicated on the marking label. If you are not sure of the type of power supply to your home, consult your product dealer or local power company. For products intended to operate from battery power, or other sources, refer to the operating instruction.
20. Object and Liquid Entry - Never push objects of any kind into this product through openings as they may touch dangerous voltage points or short-out parts that could result in a fire or electric shock. Never spill liquid of any kind on the product.
21. Damage Requiring Service - Unplug this product from the wall outlet and refer servicing to qualified service personnel under the following conditions:
  - a) When the power-supply cord or plug is damaged,
  - b) If liquid has been spilled, or objects have fallen into the product,
  - c) If the product has been exposed to rain or water,
  - d) If the product does not operate normally by following the operating instructions. Adjust only those controls that are covered by the operating instructions as an improper adjustment of other controls may result in damage and will often require extensive work by a qualified technician to restore the product to its normal operation.
  - e) If the product has been dropped or damaged in any way, and
  - f) When the product exhibits a distinct change in performance - this indicates a need for service.
22. Main plug is used as disconnect device and it should remain readily operable during intended use. In order to disconnect the apparatus from the mains completely, the mains plug should be disconnected from the mains socket outlet completely.
23. Battery shall not be exposed to excessive heat such as sunshine, fire or the like.
24. Excessive sound pressure from earphones and headphone can cause hearing loss.

This symbol indicates that this product incorporates double insulation between hazardous mains voltage and user accessible parts. 

**CAUTION:**  
TO PREVENT ELECTRIC SHOCK, MATCH WIDE BLADE OF AC PLUG TO WIDE SLOT. FULLY INSERT.

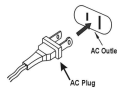

## SAVE THESE INSTRUCTIONS

E-2

### COMPLIANCE WITH FCC REGULATIONS

This device complies with Part 15 of the FCC Rules. Operation is subject to the following two conditions:

- (1) This device may not cause harmful interference, and
- (2) This device must accept any interference received, including interference that may cause undesired operation.

This equipment has been tested and found to comply with the limits for a Class B Digital Device, pursuant to Part 15 of the FCC Rules. These limits are designed to provide reasonable protection against harmful interference in a residential installation. This equipment generates, uses and can radiate radio frequency energy and, if not installed and used in accordance with the instructions, may cause harmful interference to radio communications. However, there is no guarantee that interference will not occur in a particular installation. If this equipment does cause harmful interference to radio or television reception, which can be determined by turning the equipment off and on, the user is encouraged to try to correct the interference by one or more of the following measures:

- Reorient or relocate the receiving antenna.
- Increase the separation between the equipment and receiver.
- Connect the equipment into an outlet on a circuit different from that to which the receiver is connected.
- Consult the dealer or an experienced radio/TV technician for help.

#### WARNING

Changes or modifications to this unit not expressly approved by the party responsible for compliance could void the user's authority to operate the equipment.

### CAUTION

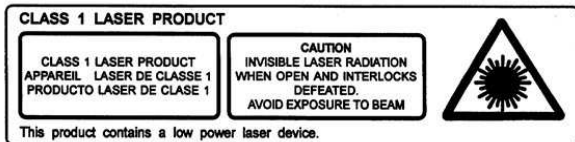

Follow the advice below for safe operations.

#### ON PROTECTION AGAINST LASER ENERGY EXPOSURE

- As the laser beam used in this compact disc player is harmful to the eyes, do not attempt to disassemble the casing.
- Stop operation immediately if any liquid or solid object should fall into the cabinet.
- Do not touch the lens or poke at it. If you do, you may damage the lens and the player may not operate properly.
- Do not put anything in the safety slot. If you do, the laser diode will be ON when the CD door is still open.
- If the unit is not to be used for a long period of time, make sure that all power sources are disconnected from the unit. Remove all batteries from the battery compartment.
- This unit employs a laser. The use of controls or adjustment or performance of procedures other than those specified here may result in exposure to hazardous radiation.

Should any trouble occur, remove the power source and refer servicing to qualified personnel.

E-3

**PROTECT YOUR FURNITURE**

This system is equipped with non-skid rubber 'feet' to prevent the product from moving when you operate the controls. These 'feet' are made from non-migrating rubber material specially formulated to avoid leaving any marks or stains on your furniture. However certain types of oil based furniture polishes, wood preservatives, or cleaning sprays may cause the rubber 'feet' to soften, and leave marks or a rubber residue on the furniture.

To prevent any damage to your furniture we strongly recommend that you purchase small self-adhesive felt pads, available at hardware stores and home improvement centers everywhere, and apply these pads to the bottom of the rubber 'feet' before you place the product on fine wooden furniture.

**DEAR JENSEN® CUSTOMER**

Selecting fine audio equipment such as the unit you've just purchased is only the start of your musical enjoyment. Now it's time to consider how you can maximize the fun and excitement your equipment offers. This manufacturer and the Electronic Industries Association's Consumer Electronics Group want you to get the most out of your equipment by playing it at a safe level. One that lets the sound come through loud and clear without annoying blaring or distortion and, most importantly, without affecting your sensitive hearing. Sound can be deceiving. Over time your hearing "comfort level" adapts to higher volumes of sound. So what sounds "normal" can actually be loud and harmful to your hearing. Guard against this by setting your equipment at a safe level BEFORE your hearing adapts.

**To establish a safe level:**

- Start your volume control at a low setting.
- Slowly increase the sound until you can hear it comfortably and clearly, and without distortion.
- Once you have established a comfortable sound level : Set the dial and leave it there.

Taking a minute to do this now will help to prevent hearing damage or loss in the future. After all, we want you listening for a lifetime.

**We Want You Listening For a Lifetime**

Used wisely, your new sound equipment will provide a lifetime of fun and enjoyment. Since hearing damage from loud noise is often undetectable until it is too late, this manufacturer and the Electronic Industries Association's Consumer Electronics Group recommend you avoid prolonged exposure to excessive noise.



**Customer's Record:**

The serial number of this product is found on its bottom cover. You should note the serial number of this unit in the space provided as a permanent record of your purchase to aid in identification in the event of theft or loss.

Model Number : JMC-1250

Serial Number :

E-4

**LOCATION OF CONTROLS**

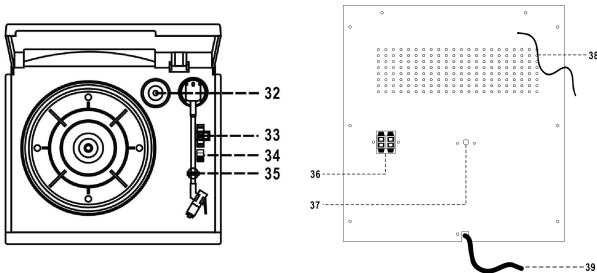
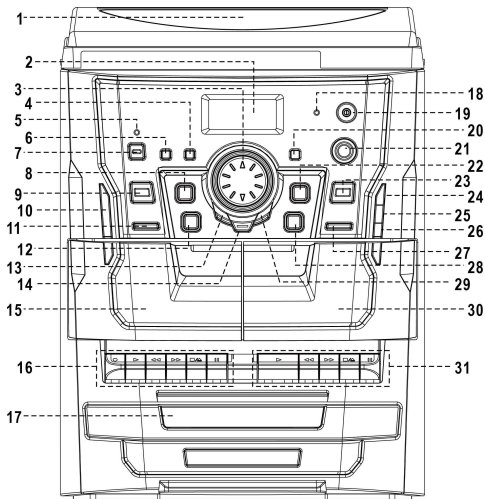

E-5

- |                                    |                                 |
|------------------------------------|---------------------------------|
| 1 DUST COVER                       | 20 REMOTE SENSOR                |
| 2 LCD DISPLAY                      | 21 PRE-SET EQ BUTTON            |
| 3 VOLUME UP/DOWN BUTTON            | 22 PLAY/PAUSE ►   BUTTON        |
| 4 X-BASS BUTTON                    | 23 DISC SKIP BUTTON             |
| 5 STANDBY LED INDICATOR            | 24 PHONO/BLUETOOTH/AUX BUTTON   |
| 6 FM MODE / DUBBING SPEED SELECTOR | 25 TUNER/BAND BUTTON            |
| 7 POWER ON/STANDBY BUTTON          | 26 TAPE BUTTON                  |
| 8 STOP ■                           | 27 CD DOOR OPEN/CLOSE BUTTON    |
| 9 REP/RAN BUTTON                   | 28 SKIP / TUNING UP ►►   BUTTON |
| 10 CD BUTTON                       | 29 +10 / PRE-UP ▲ BUTTON        |
| 11 SLEEP/TIMER BUTTON              | 30 CASSETTE DOOR (2)            |
| 12 SKIP / TUNING DOWN ◀◀   BUTTON  | 31 DECK 2 CONTROL KEYS          |
| 13 -10 / PRE-DN ▼ BUTTON           | ▶ PLAYBACK KEY                  |
| 14 MEM/CLK-ADJ BUTTON              | ◀◀ REWIND KEY                   |
| 15 CASSETTE DOOR (1)               | ▶▶ FAST FORWARD KEY             |
| 16 DECK 1 CONTROL KEY              | ■▲ STO/EJECT KEY                |
| ● RECORD KEY                       | PAUSE KEY                       |
| ▶ PLAYBACK KEY                     | 32 SPINDLE ADAPTOR              |
| ◀◀ REWIND KEY                      | 33 TURNTABLE SPEED SELECTOR     |
| ▶▶ FAST FORWARD KEY                | 34 AUTO STOP SWITCH             |
| ■▲ STO/EJECT KEY                   | 35 PICK-UP HOLDER               |
| PAUSE KEY                          | 36 SPEAKER WIRE TERMINALS       |
| 17 CD DOOR                         | 37 AUX IN JACK                  |
| 18 BLUETOOTH INDICATOR             | 38 FM ANTENNA                   |
| 19 HEADPHONE JACK                  | 39 AC CORD                      |

E-6

## REMOTE CONTROL

### BUTTON DESCRIPTION

OPEN/CLOSE	PRESS TO OPEN & CLOSE THE CD DOOR	
POWER	PRESS TO TURN THE UNIT ON AND OFF (STANDBY MODE)	
DISC 1,2,3	PRESS TO SELECT THE DISC FOR PLAYBACK DIRECTLY	
DISC-CH	PRESS TO SELECT THE NEXT DESIRE DISC AND ROTATE THE DISC TRAY	
SLEEP	PRESS TO ACTIVE SLEEP FUNCTION	
TIMER	PRESS TO SET THE ALARM MODE ON/OFF	
PHONO/BT/AUX	PRESS TO ACTIVE PHONO/BLUETOOTH OR AUX MODE	
EQ	PRESS TO SELECT EQ MODE	
TIMER MODE	TO REVIEW AND SET THE ALARM ON/OFF TIME	
CD	PRESS TO ACTIVE CD MODE	
TAPE	PRESS TO ACTIVE TAPE MODE	
TUNER/BAND	PRESS TO ACTIVE TUNER MODE AND SELECT RADIO BAND	
VOLUME +/-	CONTROL VOLUME UP DOWN	
SKIP UP/DOWN	IN CD MODE : TO SELECT PREVIOUS / NEXT CD TRACK IN TUNER MODE : PRESS TO STEP UP/DOWN OF FREQUENCY	
PLAY/PAUSE ►	IN CD MODE, PRESS ONCE TO START PLAYBACK. PRESS ONCE AGAIN TO STOP THE DISC PLAY TEMPORARILY	
STOP ■	IN CD MODE, PRESS TO TERMINATE CD PLAYBACK IN TUNER MODE, PRESS TO SELECT THE RADIO BAND	
-10M-DOWN	IN CD MODE : PRESS TO SKIP 10 SKIP BACKWARD IN TUNER MODE : PRESS TO CALL OUT THE PRESET MEMORY IN BACK	
+10M-UP	IN CD MODE : PRESS TO SKIP 10 TRACK FORWARD IN TUNER MODE : PRESS TO CALL OUT THE PRESET MEMORY IN UP	
MEMORY/CLK-ADJ	IN STANDBY MODE, FOR CLOCK SETTING IN TUNER MODE, FOR PRE-SETTING OF RADIO STATION INTO MEMORY	
REP/RAN	IN CD MODE: PRESS TO ACTIVE THE REPEAT/RANDOM FUNCTION	

E-7

## BATTERY INSTALLATION

The battery compartment is located on the back of the remote control.

1. Remove the battery compartment door by pressing in on the tab and lifting it off.
2. Insert two AAA size batteries (not included) into the battery compartment following the polarity markings inside the battery compartment.
3. Replace the battery compartment door.

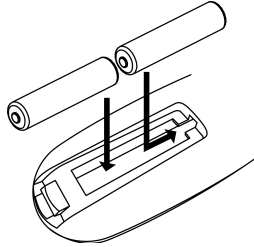

## BATTERY WARNING

1. Be sure that the batteries are installed correctly. Wrong polarity may damage the unit.
2. Use only the size and type of batteries specified.
3. Do not mix old and new batteries.
4. Do not mix alkaline, standard (carbon-zinc) or rechargeable (nickel-cadmium) batteries.
5. If the unit is not to be used for an extended period of time, remove the batteries. Old or leaking batteries can cause damage to the unit and may void the warranty.
6. Do not try to recharge batteries not intended to be recharged; they can overheat and rupture. (Follow battery manufacturer's directions).
7. Do not dispose of batteries in fire, batteries may leak or explode.

## GETTING STARTED

1. Connect the speaker wires to the speaker terminals (#36) located on the back of the unit.
2. Plug the AC POWER CORD (#39) into a 120V AC ~ 60Hz outlet.
3. The unit will go into standby mode. The STANDBY LED INDICATOR (#5) will turn on.
4. Press the POWER ON/STANDBY BUTTON (#7) once to turn on the JMC-1250. The STANDBY LED INDICATOR (#5) will turn off.  
Press POWER ON/STANDBY BUTTON (#7) again to turn off the JMC-1250. The STANDBY LED INDICATOR (#5) will turn on.

E-8

## SETTING THE CLOCK

The clock has to be set before using the system for the first time. When you plug the system into an AC outlet for the first time, the LCD DISPLAY (#2) will show 12:00 and need to be set.

1. Press MEMORY / CLOCK-ADJUST BUTTON (#14), the Hour digits will flash. Press ◀ OR ▶ BUTTON (#12 or #28) to select the correct hour. Press the MEMORY / CLOCK-ADJUST BUTTON (#14) to confirm.
2. The Minute digits will flash, Press ◀ OR ▶ BUTTON (#12 or #28) to select the correct minute. Press the MEMORY / CLOCK-ADJUST BUTTON (#14) to confirm.
3. Press and hold the STOP ■ BUTTON (#8) to change 12/24 hours clock display.

Note : The clock settings may be lost if the main power switch is turned off. If this occurs, you will need to reset the clock

## LISTENING TO THE RADIO

1. Press the POWER ON/STANDBY BUTTON (#7) to turn on the JMC-1250.
2. Press the TUNER/BAND BUTTON (#25) repeatedly to enter tuner mode and desired band. The radio frequency will show on the LCD DISPLAY (#2).
3. Press and hold the ▶ button (#28) or ◀ button (#12) to search for the next / previous available station. If the reception is poor, try Manual Tuning to fine-tune the station.
4. Press the ▶ button (#28) or ◀ button (#12) briefly to manually tune through the frequency band.
5. Adjust the volume control to the desired volume level.
6. Press the POWER ON/STANDBY BUTTON (#7) to turn the JMC-1250 to standby mode after listening.

### Setting the Radio Station Presets

The JMC-1250 allows you to store up to 40 station presets ( AM-20 and FM-20 ) for easy recall at any time.

1. Press the POWER ON/STANDBY BUTTON (#7) to turn on the JMC-1250.
2. Press the TUNER/BAND BUTTON (#25) repeatedly to enter tuner mode and select FM band.
3. Tune to the radio station you want to store in memory.
4. Press the MEMORY / CLOCK-ADJUST BUTTON (#14), the preset number "00" will be flashing on display.
5. Press +10 / PRE-UP ▲ BUTTON (#29 or -10 / PRE-DN ▼ BUTTON (#13) to select the desired preset number ( 00-20 ).
6. Press the MEMORY / CLOCK-ADJUST BUTTON (#14) to confirm.
7. To store up to 20 stations presets, repeat steps 3 to 6 above.
8. Press the TUNER/BAND BUTTON (#25) repeatedly to enter tuner mode and select AM band.
9. To store up to 20 stations presets, repeat steps 3 to 6 above.

E-9

Note :

- If no buttons are pressed after 5 seconds when setting the Radio Station Presets, the JMC-1250 will return to tuner mode
- The Radio Station Presets may be lost if the main power switch is turned off. If this occurs, you will need to reset the Radio Station Preset.
- You can overwrite a present station by saving the new frequency in its place.

FM and FM Stereo Reception

1. Release the FM Mode button (#6) to select Stereo Mode. The LCD display (#2) will show "ST" when receiving a stereo program.
2. Press down FM Mode button (#6) to select Mono Mode. The LCD display (#2) will not show "ST" even receiving a stereo program.

Note : It is preferable to receive the program in Mono Mode when you are receiving a weak station.

#### TIPS FOR BEST RECEPTION

AM - The AM antenna is located inside the cabinet of the main unit. If AM reception is weak, change the position of cabinet until the internal antenna picks up the strongest signal.

FM - During FM reception, always keep the FM Wire Antenna (#38) fully extended. If FM reception is weak try repositioning the FM Wire Antenna until you find the strongest signal.

### PHONO OPERATION

Noted :

- Remove the stylus protector.
- Be sure that the tone arm is being detached from the tone arm rest before operating and re-secured again afterwards.

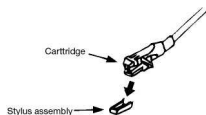

1. Press the PHONO/BLUETOOTH/AUX BUTTON (#24) repeatedly to select Phono Mode. The LCD DISPLAY (#2) will show PHONO.
2. Set the Speed selector (#33) to the proper position depending on the record to be played.
3. Place the record on the platter; use the SPINDLE ADAPTOR (#32) when playing 45 RPM records.
4. Lift the tone arm from the rest and slowly move it to the record side. The platter will start to rotate.
5. Place the tone arm to the desired position of the record.
6. Adjust the volume to the desired level.
7. At the end of record, the platter will automatically stop rotating. Lift the tone arm from the record and return it to the rest.
8. To stop manually, lift the tone arm from the record and return it to the rest.

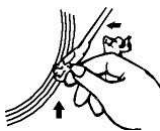

E-10

Remark :

The auto-stop may not work on some records because the play area is out of the preset adjustment, so it may stop before the last track finishes. When this happens disable the auto-stop feature by placing the auto-stop switch (#34) in the "off" position, then it will run to the end of the record but will not stop automatically (turn off the unit by power button or switch back the auto-stop switch (#34) to "on" position to stop the platter rotate). Then put back the tone arm to the rest position.

### BLUETOOTH OPERATION

Pairing a Bluetooth enabled device with the JMC-1250.

1. Press the POWER ON/STANDBY BUTTON (#7) to turn on the JMC-1250.
2. Press the PHONO/BLUETOOTH/AUX BUTTON (#24) repeatedly to select Bluetooth Mode. The LCD DISPLAY (#2) will show BT.
3. The BLUETOOTH INDICATOR (#18) will flash. The JMC-1250 will go into Pairing/Discoverable mode.
4. Turn on the Bluetooth function for the device you want to link to, and enable the search or scan function to find the JMC-1250.
5. Select "JMC-1250" from the device list when it appears on your device screen. If required, enter the pass code "0000" to pair (link) JMC-1250 with your device.
6. If you are pairing (linking) your computer to the speaker using Bluetooth, you may need to set the JMC-1250 as your computer's default sound device.
7. After successfully pairing the JMC-1250 with your Bluetooth device, The BLUETOOTH INDICATOR (#18) will stop flashing and remain lit.
8. If you want to pair (link) the JMC-1250 with another Bluetooth device, press and hold Play/Pause ►|| button (#22) a few seconds. The BLUETOOTH INDICATOR (#18) will flash. The JMC-1250 will go into Pairing/Discoverable mode. Repeat steps 4 & 5.

Now you can play music from your Bluetooth device wirelessly to the JMC-1250.

1. Select your favorite song, press the Play/Pause on your Bluetooth device or the Play/Pause ►|| Button (#22) on the JMC-1250 to play or pause the song from your Bluetooth device.
2. Press the Skip Forward ►►| Button (#12) or Skip Backward |◄◄ Button (#9) to select the Next or Previous track.  
(The SEARCH function does not apply to Bluetooth operation )
3. Slowly adjust both the volume controls of your JMC-1250 and your Bluetooth device until you reach a comfortable listening level.

Note :

1. Refer to the manual of your cell phone, tablet PC, computer or other Bluetooth enabled devices for Bluetooth operation since it may vary from model to model.
2. If your Bluetooth enabled device does not support A2DP profile, it will not play the music through the speaker, even if paired (linked).
3. Remember to turn off the JMC-1250 when you have finished listening.

E-11

4. Don't forget to switch off the power of your Bluetooth device as well.
5. The music playback will automatically be paused when you have an incoming call. When the call is ended, the JMC-1250 will start playing again.

#### AUX IN OPERATION

You can play other music sources (iPod, MP3 or other digital audio players) through the speakers of the JMC-1250 by connecting the AUX IN Jack (#37) to your external player's audio out jack or headphone jack.

1. Plug one end of an audio cable (not included) into the AUX IN Jack (#37) and the other end of the cable to the headphone jack of your digital audio player.
2. Press POWER ON/STANDBY BUTTON (#7) to turn on the JMC-1250.
3. Press PHONO/BLUETOOTH/AUX BUTTON (#24) repeatedly to select AUX Mode. The LCD DISPLAY (#2) will show AUX.
4. Start playing the device you plugged into the AUX IN Jack (#37).
5. Slowly adjust both the volume controls of your JMC-1250 and the external device until you reach a comfortable listening level.

Note :

- If you connect the JMC-1250 to the Line-Out Jack of your external device, you only need to adjust the VOLUME CONTROL of your JMC-1250. If you connect to the Headphone Jack of your external device, you may need to adjust both the volume controls of your external device and the JMC-1250 to obtain the desirable listening level.
- Remember to turn off the JMC-1250 when you have finished listening. Don't forget to switch off the power of your external audio device as well.

#### CD OPERATION

##### □ LOADING THE DISCS

1. Press the POWER ON/STANDBY BUTTON (#7) to turn on the JMC-1250.
2. Press the CD BUTTON (#10) to enter CD Mode. The LCD DISPLAY (#2) will show CD.
3. Press the CD DOOR OPEN/CLOSE BUTTON (#27) to open the CD DOOR (#17).
4. Place a CD with the printed side facing up inside the tray.
5. Press the DISC SKIP BUTTON (#23) to select another location on the CD tray. Load another CD. You can load up to 3 CDs at a time by repeating the step.
6. Press the CD DOOR OPEN/CLOSE BUTTON (#27) again to close the CD DOOR (#17).
7. CD search will be performed; the display will show the total number of discs, number of tracks and playing time of the disc.

**Note:** CD searching will be performed every time when you switch to CD mode or if you close the CD door. All CD functions will start responding when the CD searching is completed.

E-12

##### □ CD PLAY / PAUSE MODE

1. Press the PLAY/PAUSE BUTTON (#22) to start playback. The first track of the first disc will be played and the play indicator will appear on the LCD DISPLAY (#2).
2. You can also press either the " DISC 1 ", " DISC 2 ", " DISC 3 " buttons on the remote control to start playing a specific disc in the tray.
3. To interrupt, press the PLAY/PAUSE BUTTON (#22) once, and the display will start flashing. Press again to resume playback.

##### □ STOP MODE

1. If the STOP BUTTON (#8) is pressed during PLAY or PAUSE, the system will go into stop mode.

##### □ SKIP MODE (SKIP UP▶▶/SKIP DOWN◀◀)

1. During PLAY or PAUSE mode, if the SKIP / TUNING UP ▶▶ BUTTON (#28) is pressed, the player will go to next track and display the track no. and then remain the PLAY or PAUSE mode.
2. During PLAY or PAUSE mode, if the SKIP / TUNING DOWN ◀◀ BUTTON (#12) pressed, the player will go back to the beginning of the track. Press the SKIP / TUNING DOWN ◀◀ BUTTON (#12) again will go to the previous track.

##### □ SEARCH MODE (SEARCH UP▶▶▶/SEARCH DOWN◀◀◀)

1. During PLAY mode, if the SKIP / TUNING UP ▶▶▶ BUTTON (#28) is pressed & held for few seconds, it will start searching forward.
2. During play mode, if the SKIP / TUNING DOWN ◀◀◀ BUTTON (#12) is pressed & held for few seconds, it will start searching backwards.

##### □ REPEAT PLAY

This function allows you to repeat 1 single track, 1 single disc or all discs:-  
Press the REP/RAN BUTTON (#9) repeatedly to switch the function:-

REP. ALL DISC    →    REP. 1 DISC    →    REP. 1 TRACK    →    REP. OFF

↑\_\_\_\_\_↓

**Note:** Single track repeat function is possible in normal or programmed playback, repeat one disc or all discs is only available in normal playback.

##### □ RANDOM PLAY

You can listen all the tracks of all available discs in a random order by using this function

1. Press and hold the REP/RAN BUTTON (#9), the unit will play all discs randomly. All tracks of all the discs will be played in random order.
2. Press and hold the REP/RAN BUTTON (#9) again, the unit will play 1 disc randomly. All tracks of 1 disc will be played in random order.
3. Press and hold the REP/RAN BUTTON (#9) again, the unit will cancel the randomly random playback.

E-13

## □ CD PROGRAMMING

Up to 60 tracks can be programmed to be played in any required order from one CD or all CDs in the CD changer.

1. Set in CD mode and press the STOP ■ BUTTON (#8).
2. Press the MEM/CLK-ADJ BUTTON (#14)
3. Press the DISC SKIP BUTTON (#23) to select the desired disc.
4. Press SKIP DOWN ◀◀ BUTTON (#12) or SKIP UP ▶▶ BUTTON (#28) to select the desired track.
5. Press the MEM/CLK-ADJ BUTTON (#14) again to store the track in memory.
6. Repeat steps 2 to 5 to enter additional program.
7. Press the PLAY/PAUSE ▶|| BUTTON (#22) to start playback in order.

Press the STOP ■ BUTTON (#8) to stop playback and press it twice to clear all programmed track

## TAPE OPERATION

### GENERAL OPERATION

- Press POWER ON/STANDBY BUTTON (#7) to turn on the JMC-1250.
- Press TAPE BUTTON (#26) to enter Tape Mode. The LCD DISPLAY (#2) will show TAPE.

STOP / EJECT KEY ■▲ Press to stop all deck operations. Press again to open the cassette door.

FAST FORWARD KEY ▶▶ & REWIND KEY ◀◀ Press to start rapid tape winding in either forward or reverse direction. Press the stop / eject key when the cassette spools stop turning.

PLAY KEY ▶ Press to start playing tape.

PAUSE KEY || Press to stop the tape operation temporarily. Press again to resume.

RECORD KEY ● (DECK 1 ONLY) Press together with play key to start tape recording.

### PLAYBACK

- Put in a cassette tape.
- Press the PLAY button to active playback
- Adjust the volume control to the desired level.
- Use the PAUSE button when you want to stop playback temporarily.
- Press the STOP / EJECT button when finished.

E-14

## CONTINUOUS PLAYBACK OF TWO CASSETTES

- 1.) Insert a pre-recorded tape into both cassette compartments with the tape you want to play first in DECK 2.
- 2.) Press the Play ▶ button on DECK 2 to begin playback.
- 3.) Press the Pause || button and then Play ▶ button of DECK 1.
- 4.) When the tape in DECK 2 ends, it stops and the Pause || key of DECK 1 will release automatically to begin playback on DECK 1.

**NOTE:** Continuous playback will not function if you play the tape in DECK 1 first.

## RECORDING

This cassette recorder features an Automatic Recording Volume Level Control System that prevents overloaded or distorted recordings. You can change the volume level as often as you like during the recording process. It will not have any effect on the volume level of the recording itself.  
Insert a good quality blank tape into DECK 1 with the exposed tape facing down and the full reel on the left side. Close DECK 1 door.

### A. RECORDING FROM TAPE (DECK 2 TO DECK 1)

This unit enables you to duplicate a pre-recorded tape to another tape. It is performed only one way from deck 2 (playback) to deck 1 (recording).

#### DUBBING AT NORMAL SPEED

- Press the TAPE BUTTON (#26) to enter Tape Mode.
- Inset a pre-recorded cassette into deck 2 and a blank cassette tape into deck 1.
- Press the " PAUSE " key and then press the " RECORD " and " PLAY " key at deck A.
- Press the " PLAY " key to start playback at deck 2 and then release " PAUSE " key at deck 1 to start dubbing.
- Press " PAUSE " key at deck 1 and " STOP " key at deck 2 when finish.

#### DUBBING AT HIGH SPEED

- This unit is equipped with a high speed dubbing system that saves dubbing time by 2/3 when compare to normal speed.
- Push the FM MODE/DUBBING SPEED SELECTOR BUTTON (#6) to " HI " position and then follow the same procedures as covered in "dubbing at normal speed".
  - When dubbing a pre-recorded cassette tape at high speed, a chattering sound is being heard. to avoid this, set the volume control to a minimum level.
  - Do not push the FM MODE/DUBBING SPEED SELECTOR BUTTON (#6) during dubbing, this will vary the speed of recording and may be damage the cassette tape.

### B. RECORDING FROM THE RADIO

- Press the TUNER/BAND BUTTON (#25) to enter radio mode
- Tune to the desired station and insert a blank cassette tape in deck 1.
- Press the "RECORD" & "PLAY" button to start recording.
- Press the "PAUSE" keys and then the "STOP/EJECT" key when finish.

E-15



### C. RECORDING FROM CD

- Press the CD BUTTON (#10) to enter CD Mode.
- Insert a blank cassette tape in deck 1 which suitable for recording.
- Press the "PAUSE" button first and then "RECORD" & "PLAY" key at deck 1. Recording function is now on STANDBY.
- Activate the CD player, and then press the "PAUSE" key at deck 1 to start recording.
- To stop recording, press the "STOP" button on CD player first, then press the "PAUSE" key and then the "STOP/EJECT" key at deck 1.

### D. RECORDING FROM THE TURNTABLE

- Press the PHONO/BLUETOOTH/AUX BUTTON (#24) to enter Phone Mode.
- Place a record onto turntable and insert a blank cassette tape into deck 1.
- Press the " PAUSE " key and then press the " RECORD " and " PLAY " key at deck 1.
- Place tone arm to start playback the record and then press " PAUSE " key at deck 1 to start recording.
- Press " PAUSE " or " STOP " key at deck 1 when finish.

## MORE FEATURES

### A. SLEEP TIMER SETTING

1. Press and hold the SLEEP/TIMER BUTTON (#11) on main unit or the "SLEEP" button on remote, to active and adjust the sleep timer in the order of 90 > 80 >70....10 minutes automatically. Release the button at sleep timer you want to select. The LCD display (#2) will show SLEEP.
2. System will stop and go to STANDBY mode automatically after the selected timing.
3. To cancel the sleep mode, press SLEEP/TIMER BUTTON (#11) on main unit or "SLEEP" on the remote once, " SLEEP " indicator on the display disappears.

### B. ON/OFF TIMER SETTING (BY REMOTE ONLY)

This function allows the system to turn on automatically and wake you up by soft CD music or with the radio and shut itself off (standby mode) when time is up.

1. In unit standby mode, press the MODE button on remote once, the LCD display (#2) will show "ON" and flash.
2. Press and hold MEM/CLOCK-ADJ button (#14) a few seconds, the hour digits will flash. Press SKIP UP/ DOWN buttons (#28/12) to set the hour.
3. Press MEM/CLOCK-ADJ button (#14) to confirm. Minute digits will flash and prompt for input.
4. Press the SKIP UP/ DOWN buttons (#28/12) to set the minute. Press MEM/CLOCK-ADJ button (#14) to confirm.
5. Press " MODE " button on remote again to set the timer ending time. "OFF" timer will appear and flash.
6. Follow above step 2-4 to set OFF timer.

E-16

7. Press the "MODE" button on remote to confirm, "ON" icon flash and timer source CD/PHONO/TUNER/TAPE appears on the display.
8. Press the MEM/CLOCK-ADJ button (#14) once, timer source flashing.
9. Press the SKIP UP/ DOWN buttons (#28/12) to set source to be controlled by timer and then press the MEM/CLOCK-ADJ button (#14) to finish.
10. You can press the " MODE " button repeatedly to review the presets time in order.

**NOTE:** 1. The timer setting will automatically cancel if no button is pressed in a period of about 10 seconds.  
2. If you set ON/OFF timer for PHONO or TAPE, please make sure record or pre-recorded tape is installed and tone arm or cassette PLAY key is set and ready to play.

### □ ACTIVE/DE-ACTIVE THE TIMER FUNCTION

1. To active the timer function, press the SLEEP/TIMER button (#11) on main unit or "TIMER" button on remote once, the timer indicator "ON" is shown on LCD DISPLAY (#2).
2. To cancel the timer function, press the SLEEP/TIMER button (#11) on main unit or "TIMER" button on remote until the timer indicator " ON " disappear

### C. PRESET EQ FUNCTION

This unit provides 5 differences sound modes to enhance your listening experience. You can select the desired effect by pressing the PRE-SET EQ BUTTON (#21) repeatedly to get the effect you want:-

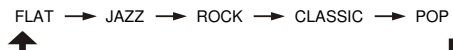

## X-BASS OPERATION

Press the X-BASS Button (#4) to enhance the bass effect of the music being played. Press the X-BASS Button again to turn the effect off.

## USING HEADPHONE

Headphones are not supplied with this Music system. You will require headphones fitted with a 3.5 mm diameter stereo plug and an impedance of 32 ohms. Plug your headphones into the HEADPHONE JACK (#19) on the front of the unit for private listening. After plugging in the headphone, the speakers will be automatically disconnected.

**WARNING : ALWAYS LOWER THE VOLUME LEVEL BEFORE PUTTING ON YOUR HEADPHONES. OTHERWISE YOUR HEARING COULD BE DAMAGED.**

E-17

## CARE AND MAINTENANCE

1. Do not subject the unit to excessive force, shock, dust or extreme temperature.
2. Do not tamper the internal components of the unit.
3. Clean your unit with a dry cloth. Solvent or detergent should never be used.
4. Avoid leaving your unit in direct sunlight or in hot, humid or dusty places.
5. Keep your unit away from heating appliances and sources of electrical noise such as fluorescent lamps or motors.

### ABOUT CASSETTE TAPES

Whenever you record on a cassette any previously recorded material is erased as the new material is recorded. To prevent you from accidentally erasing material which you wish to save, blank cassettes are equipped with erase prevention tabs for each side of the tape. If the erase prevention tab for side A is removed, you cannot accidentally record on side A. The Record ● key cannot be depressed if the erase prevention tab on the cassette has been removed.

To prevent accidental erasing on side A of a cassette use a small screw driver or similar tool to break off the erase prevention tab for side A. This prevents the record key from locking.



If later you do wish to record on side A of the cassette, cover the tab opening with a piece of cellophane tape. This will allow the Record ● to function again.

### CASSETTE CARE

Two common causes of trouble experienced when using cassettes are:

- 1) Tape Jamming – Leading to uneven speed in playback, and
- 2) Tape Tangling – Where the tape wraps itself around vital parts of the mechanism.

To reduce the likelihood of these problems occurring, the following precautions should be observed:

- Check that there are no loose layers of tape visible through the cassette center window (see Fig. 1). Take up any loose layers, using a pencil or hexagonal barrelled ballpoint pen, before inserting the cassette into the machine (see Fig.2)

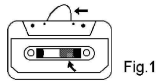

E-18

- If the cassette feels tight while performing operation shown (see Fig.2), the tape may be jamming due to ridges formed in the winding of the tape (visible through the center window). These may be removed, in most cases, by fast winding of the cassette from one end to the other and back again.
- Use only well-known brands of tape. Avoid use of C-120 cassettes.

Furthermore, do not expose cassettes to direct sunlight, dust or oil, and do not touch the tape surfaces.

### HEAD CLEANING

The tape heads, pinch roller and capstan require periodic cleaning. This removes particles of the metal oxide coating that wear off the tape and accumulate on these parts and impair performance. Switch off the power, press the Stop/Eject ■ key to open the cassette door, and press the Play ► key. Clean the tape heads, pinch roller and capstan with a soft cloth or cotton pad dampened in isopropyl alcohol or special tape head cleaner.

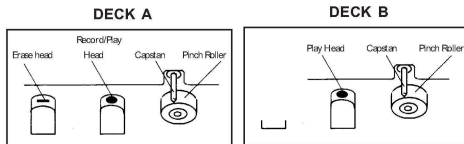

1. Avoid operating your unit under direct sunlight or in hot, humid or dusty places.
2. Keep your unit away from heating appliances and sources of electrical noise such as fluorescent lamps or motors.
3. For better Clock Display clarity, avoid operating the unit under direct sunlight or in strong room illumination.
4. Unplug the unit from the electrical power outlet immediately in case of malfunction.



Fig. 2

**TROUBLE SHOOTING GUIDE**

<b>PROBLEM</b>	<b>POSSIBLE CAUSE</b>	<b>SOLUTION</b>
The unit does not respond (no power)	The unit is disconnected from the AC outlet	Reconnect to the AC outlet.
	AC outlet is not functioning.	Plug another device into the same outlet to confirm the outlet is working.
AM band is too noisy	The reception at the set location is poor.	Slightly rotate the unit for the best reception.
Radio paused about 1 second when switch from phonograph mode to tuner mode	This is normal.	Radio will resume normal function in 1-2 seconds.
Sound is distorted	Volume level is set to high.	Decrease the volume.
	Sound source is distorted.	Try a different audio source such as a music CD.
CD Player does not play.	CD Mode is not selected.	Slide the FUNCTION switch to select CD mode.
	CD is not installed or installed incorrectly.	Press the CD onto spindle, printed side facing up.
CD skip while playing	Disc is dirty or scratched.	Wipe with cloth or another disc.
Unit gets warm after extended play at high volume	This is normal	Turn the unit off for a period of time or lower volume.

E-20

**SPECIFICATION**

**Power Requirement**

Main unit: AC120V~ 60Hz

Remote control: 2 x 1.5V "AAA" (UM-4) size batteries (not included)

**Frequency Range**

Radio Band: FM 88 ~ 108 MHz  
AM 520 ~ 1710 KHz

**Power Consumption**

Main Unit: 35Watts

**SPECTRA GREEN NOTICE**



At Spectra, environmental and social responsibility is a core value of our business. We are dedicated to continuous implementation of responsible initiatives with an aim to conserve and maintain the environment through responsible recycling.

Please visit us at <http://www.spectraintl.com/green.htm> for more information on Spectra's green initiatives or to find a recycler in your area.

The Bluetooth® word mark and logos are registered trademarks owned by Bluetooth SIG, Inc. and any use of such marks by Spectra Merchandising Intl, Inc. is under license. Other trademarks and trade names are those of their respective owners.

E-21

**90 DAY LIMITED WARRANTY AND SERVICE VALID IN THE U.S.A. ONLY**

SPECTRA MERCHANDISING INTERNATIONAL, INC. warrants this unit to be free from defective materials or factory workmanship for a period of 90 days from the date of original customer purchase and provided the product is utilized within the U.S.A. This warranty is not assignable or transferable. Our obligation under this warranty is the repair or replacement of the defective unit or any part thereof, except batteries, when it is returned to the SPECTRA Service Department, accompanied by proof of the date of original consumer purchase, such as a duplicate copy of a sales receipt.

You must pay all shipping charges required to ship the product to SPECTRA for warranty service. If the product is repaired or replaced under warranty, the return charges will be at SPECTRA's expense. There are no other express warranties other than those stated herein.

This warranty is valid only in accordance with the conditions set forth below:

1. The warranty applies to the SPECTRA product only while:
  - a. It remains in the possession of the original purchaser and proof of purchase is demonstrated.
  - b. It has not been subjected to accident, misuse, abuse, improper service, usage outside the descriptions and warnings covered within the user manual or non-SPECTRA approved modifications.
  - c. Claims are made within the warranty period.
2. This warranty does not cover damage or equipment failure caused by electrical wiring not in compliance with electrical codes or SPECTRA user manual specifications, or failure to provide reasonable care and necessary maintenance as outlined in the user manual.
3. Warranty of all SPECTRA products applies to residential use only and is void when products are used in nonresidential environment or installed outside the United States.

This warranty gives you specific legal rights, and you may also have other rights which vary from state to state. TO OBTAIN SERVICE please remove all batteries (if any) and pack the unit carefully and send it freight prepaid to SPECTRA at the address shown below. IF THE UNIT IS RETURNED WITHIN THE WARRANTY PERIOD shown above, please include a proof of purchase (dated cash register receipt) so that we may establish your eligibility for warranty service and repair of the unit without cost. Also include a note with a description explaining how the unit is defective. A customer service representative may need to contact you regarding the status of your repair, so please include your name, address, phone number and email address to expedite the process.

IF THE UNIT IS OUTSIDE THE WARRANTY PERIOD, please include a check for \$120.00 to cover the cost of repair, handling and return postage. All out of warranty returns must be sent prepaid.

It is recommended that you contact SPECTRA first at 1-800-777-5331 or by email at [custserv@spectraintl.com](mailto:custserv@spectraintl.com) for updated information on the unit requiring service. In some cases the model you have may be discontinued, and SPECTRA reserves the right to offer alternative options for repair or replacement.

SPECTRA MERCHANDISING INTERNATIONAL, INC.  
4230 North Normandy Avenue,  
Chicago, IL60634, USA. 1-800-777-5331

To register your product, visit the link on the website below to enter your information.  
<http://www.spectraintl.com/wform.htm>

0514

Printed in China