

Operating Manual

USER'S INSTRUCTIONS

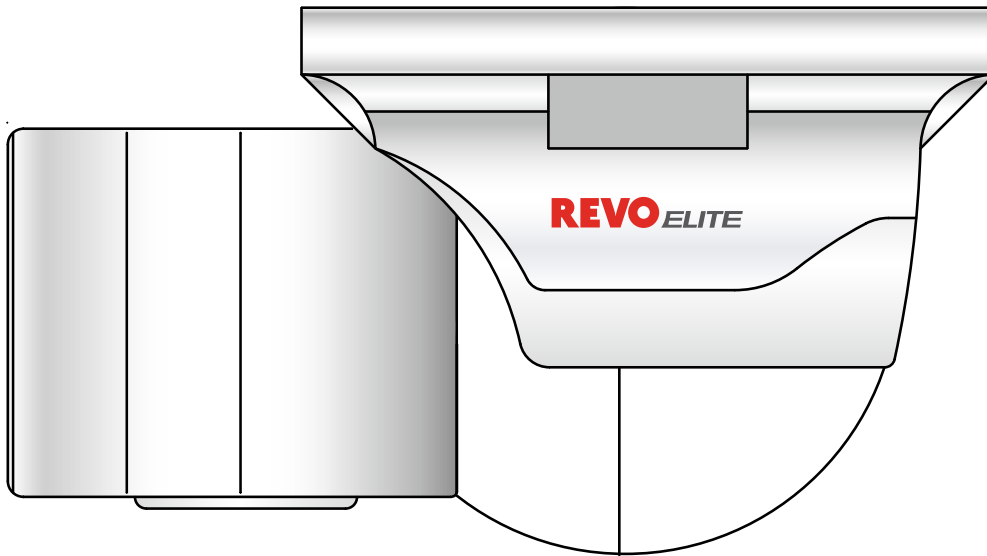

Model No.: RETRT700-1/RETRT2812-2

(DC 12V  /AC 24V ~ 60HZ, 12W / NTSC)

REVO AMERICA

www.revoamerica.com

TEL.: 1-866-625-REVO(7386)

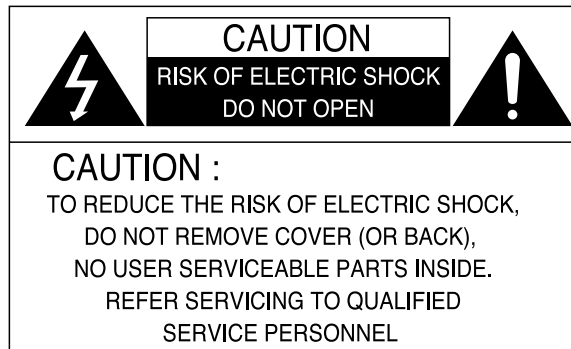

The lightning flash with an arrowhead symbol, within an equilateral triangle is intended to alert the user to the presence of uninsulated dangerous voltage within the product's enclosure that may be of sufficient magnitude to constitute a risk of electric shock to persons.



The exclamation point within an equilateral triangle is intended to alert the user to the presence of important operating and maintenance (servicing) instructions in the literature accompanying the appliance.

INFORMATION - This equipment has been tested and found to comply with limits for a Class A digital device, pursuant to part 15 of the FCC Rules. These limits are designed to provide reasonable protection against harmful interference when the equipment is operated in a commercial environment. This equipment generates, uses, and can radiate radio frequency energy and, if not installed and used in accordance with the instruction manual, may cause harmful interference to radio communications. Operation of this equipment in a residential area is likely to cause harmful interference in which case the user will be required to correct the interference at his own expense.

WARNING - Changes or modifications not expressly approved by the manufacturer could void the user's authority to operate the equipment.

WARNING - To prevent electric shock and risk of fire hazards:

- ◆ Do NOT use power sources other than that specified.
- ◆ Do NOT expose this appliance to rain or moisture.

RoHS FC

This installation should be made by a qualified service person and should conform to all local codes.

Contents

Camera Features	4
Installing & Adjusting	5
Dimension & Specification	6
OSD Control Button	7
On Screen Display (OSD) Menu	8
Accessing the OSD Menu Settings continued	9
Lens	10
Exposure	10
SSDR	12
White Balance	13
BLC	14
DNR3	16
Day/Night	17
Special	18
Image Adjust	18
Cam Title	19
Sync	20
Motion	20
Privacy	21
DIS	22
Profile	22
RETURN	22
Exit	23
Trouble Shooting	24

Camera Features

● Ultra High Sensitivity

The built-in high sensitivity COLOR CCD produces a clear image even in 0.0001Lux(Sens-up x512) lower illumination.

● 700TV Lines

By adopting a diagonal 6mm(1/3") 520,000(NTSC) pixel, 610,000(PAL) pixel SONY CCD, the camera produces clear picture quality with a horizontal resolution of 700 TV lines for color and a horizontal resolution of 750 TV lines for BW mode.

● DNR3

The high-performance SV-V DSP chip effectively removes low-light gain noise and ghosting to provide clear images even in dark environments.

● Day&Night

The camera has a function that automatically selects the mode that is appropriate for daytime or night-time conditions. The COLOR mode operates in daytime conditions to provide optimum colors, and BW mode operates in night-time conditions to enhance the definition of the image.

● SSSDR

For images with high contrast between bright and dark Areas from difficult lighting conditions such as backlighting, this camera selectively illuminates darker Areas while retaining the same light level for brighter Areas to even out the overall brightness.

● Miscellaneous Functions

HLC(High Light Compensation), SENS-UP, FLIP(H/V-REV), D-ZOOM, SHARPNESS, MOTION DETECTION and PRIVACY functions are provided.

● Profile

You can set a mode according to the camera installation conditions.

- BASIC, DAY/NIGHT, BACKLIGHT, ITS, INDOOR, USER

Installing & Adjusting

1. Installation

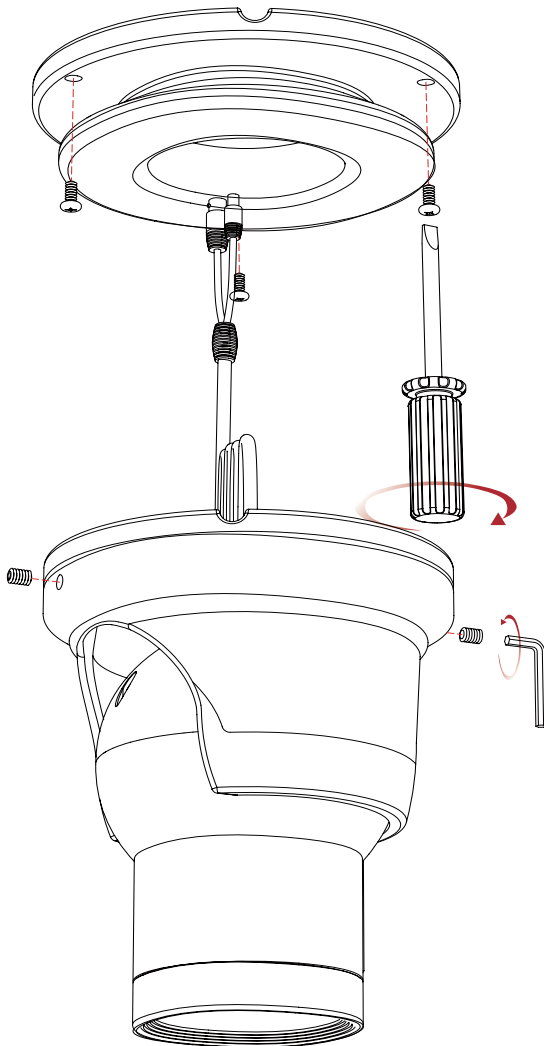

- Place the mounting plate on a flat installation surface and mount with the provided screws.
- Feed the cable through the center of the mounting plate.
- Place the camera body in the mounting plate socket and hold.
- Then place the outer plate over the camera body & mounting plate and tighten side screws to lock the camera into place.
- Loosen side screws to adjust camera angle as needed, then tighten the side screws to lock into place.

2. Focus / Zoom Screw

- To widen the viewing angle turn the Zoom screw to "W"(Wide) to obtain a closer view turn it to "T"(Tele).
- Turn the Focus screw to "N"(Near) or " ∞ "(Far) until the sharpest Focus is made.

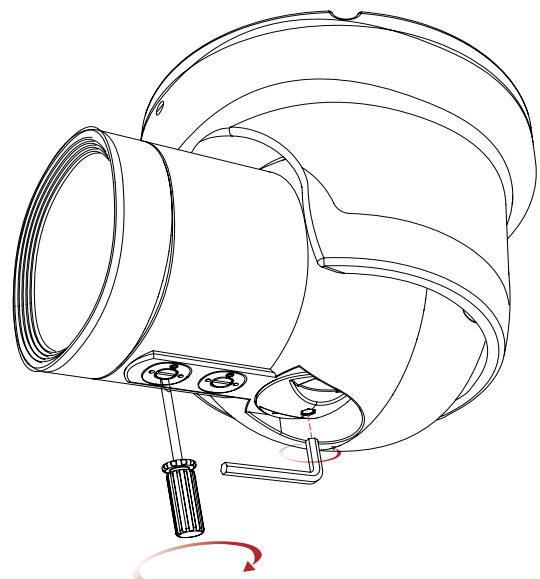

Dimension & Specification

1. Dimension & Connection

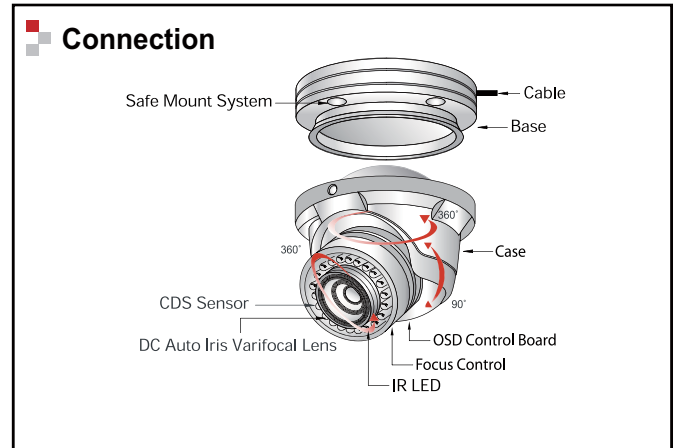
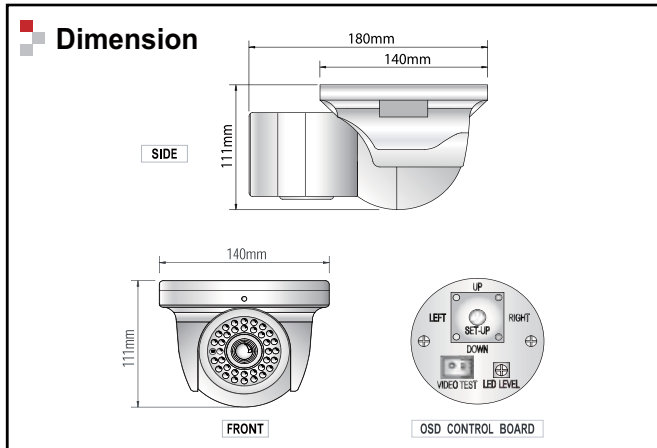

WARNING : To prevent electric shock and risk fire hazards, do not use power sources other than that specified.

2. Specification

Image Pick-Up Device	1/3" Sony Super HAD CCD
TV System	NTSC
Total Pixels	976(H) * 508(V)
Effective Pixels	976(H) * 494(V)
Scanning Frequency	15.734KHz(H) & 59.94Hz(V)
Scanning System	2:1 Interlace
Synchronization	Internal / Line-Lock
Resolution	700TVLines
Minimum Illumination	IR LED OFF : 0.15Lux, IR LED ON : 0Lux
S/N Ratio	More than 52dB
Video Output	CVBS: 1.0Vp-p / 75Ω
Electronic Shutter Speed	ESC / A.FLK / MANUAL(1/60 ~ 1/120,000)
OSD	Available
AGC	LOW / HIGH / OFF
SENS-UP	AUTO(x2~X512) / OFF
SSDR	OFF / ON(Level adjustable)
White Balance	ATW / OUTDOOR / INDOOR / MANUAL / AWC → SET
BLC	BLC / HLC / OFF
DNR3 (Digital Noise Reduction)	OFF / ON(Level adjustable)
Day & Night	EXTERN / COLOR / BW / AUTO
Special	
REVERSE	OFF / H-REV / V-REV / HV-REV
PIP	OFF / ON
D-ZOOM	OFF / ON(x1~x16)
MOTION	OFF / ON(4 Programmable Zone)
PRIVACY	OFF / ON(12 Programmable Zone)
DIS (Digital Image Stabilization)	OFF / ON
Power Supply	DC12V / AC24VnDual Voltage
Power Consumption	IR LED OFF 0.2A(DC), IR LED OFF 0.15A(AC)/IR LED ON 0.52A(DC), IR LED ON 0.48A(AC)
Lens	DC Auto Iris Varifocal Lens
Operational Temp.	-35 ~ +50 Deg C. RH95% MAX.
Storage Temp.	-35 ~ +60 Deg C. RH95% MAX.
Dimension	140mm(W) * 111mm(H) * 180mm(D)
Weight	1800g
Environmental	IP66 Weatherproof

OSD Control Button

1. OSD Button could be used when it needs to OSD control.

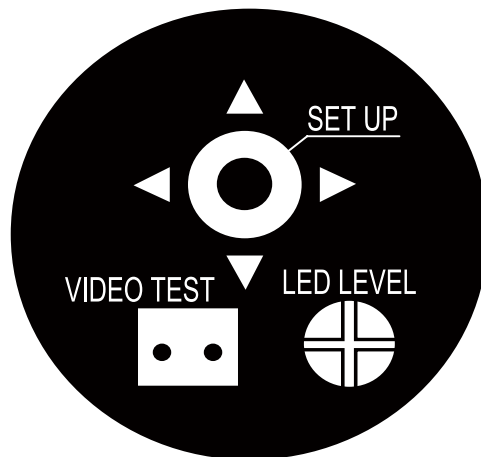

- ▲ Up button : Moves the cursor upwards. Use this button to select an item or adjust the parameters.
- ▼ Down button : Moves the cursor downwards. Use this button to select an item or adjust the parameters.
- ◀ Left button : Moves the cursor to the left. Use this button to select or adjust the parameters of the selected item. The parameter changes each time this button is pressed.
- ▶ Right button : Moves the cursor to the right. Use this button to select or adjust the parameters of the selected item. The parameter changes each time this button is pressed.
- ◎ Set button : Executes selections and displays a submenu for an item with the  mark.

On Screen Display (OSD) Menu

On Screen Display (OSD) Menu

Camera functions and settings can be adjusted or changed by activating the OSD menu.

When the OSD menu is activated text will display on the monitor. The user can then move the cursor to the desired function to change the setting.

SETUP Menu

LENS	• DC		
EXPOSURE	• BRIGHTNESS • SENS-UP	• SHUTTER • RETURN	• AGC
SSDR	• OFF	• ON	
WHITE BALANCE	• ATW • MANUAL	• OUTDOOR • ATW → SET	• INDOOR
BACKLIGHT	• OFF	• USER BLC	• HLC
DNR3	• OFF	• ON	
DAY/NIGHT	• AUTO • EXTERN	• COLOR	• B/W
SPECIAL	• IMAGE ADJ. • MOTION • PROFILE	• CAM TITLE • PRIVACY • COMM ADJ.	• SYNC • DIS • RETURN
EXIT	• SAVE	• NOT SAVE	• RESET

Accessing the OSD Menu Settings continued

1. Press the SETUP button.

- Settings can now be made. The SETUP menu is displayed on the monitor.

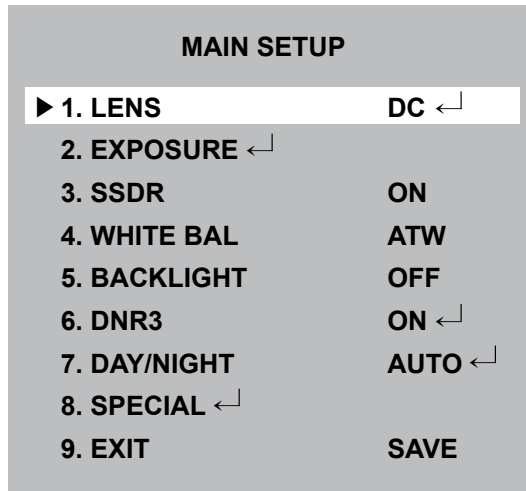

2. Select a menu item from the list available by using the Up and Down buttons.

- Functions are selected using up and down buttons.
- Place the cursor over a desired item, the selected position is displayed.

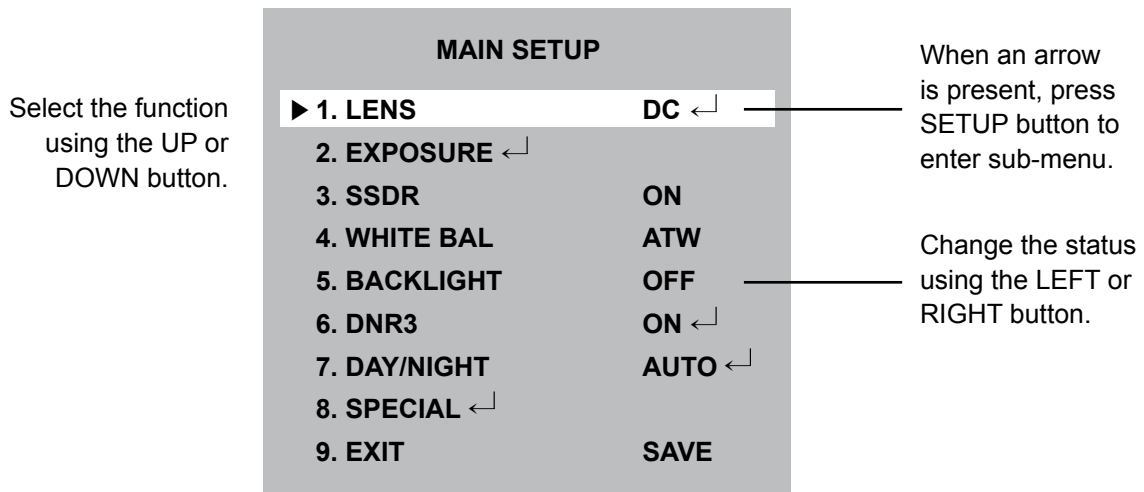

3. Set up a selected item by using the Left and Right buttons.

4. To finish the settings, select 'EXIT' and press the SET button.

NOTE

- An item with the ↵ icon also has sub menus. To select a sub menu, select an item with the ↵ icon and press the SET button.
- An item with the - - - icon has no sub-menus available for selection.

■ Lens

Using this function, you can control the screen brightness.

1. When the SETUP menu screen is displayed, select 'LENS' by using the Up and Down buttons so that the arrow indicates 'LENS'.

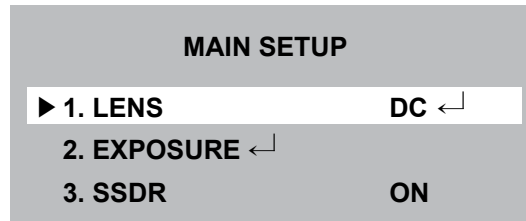

▶ **DC** : You can adjust the minimum shutter and maximum value of shutter when DC Lens mode is selected.

2. Press SETUP to choose from the sub menu items as listed below.

- ▶ **BRIGHTNESS** : Adjusts the video brightness (selectable from 1 ~ 70).
- ▶ **IRIS SPEED** : Adjusts the iris control speed of the DC lens. If the control speed is too slow or fast, use this menu to adjust the speed.
- ▶ **FOCUS ADJ.** : Press SET to enter focus menu. Then to adjust the lens focus correctly, ensure "MODE" is set to 'ON'. After lens focus has been adjusted, set "MODE" to 'OFF'.

NOTE

- If color rolling occurs when using a DC lens, set Shutter to - - -.
- Some lenses may not work properly, depending on the setting of the BRIGHTNESS LEVEL.

■ Exposure

1. When the SETUP menu is displayed, select 'EXPOSURE' by using the Up and Down buttons so that the arrow indicates 'EXPOSURE'. Press SETUP to enter.

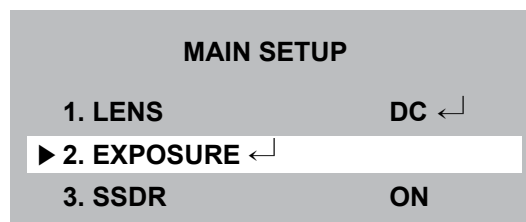

2. Select the desired mode using Up and Down buttons.

EXPOSURE SETUP	
▶ 1. BRIGHTNESS	* 25
2. SHUTTER	- - -
3. AGC	HIGH
4. SENS-UP	OFF
5. RETURN	←

- ▶ BRIGHTNESS : Adjusts the exposure brightness.
- ▶ SHUTTER : You can select either auto or manual shutter.
 - A.FLK : Select this when you experience picture flicker, which can happen when there is a clash with the frequency of the installed lighting.
 - ESC : Select this to control the shutter speed automatically. If ESC is selected, the shutter speed is automatically controlled depending on the ambient illumination of the subject.
 - MANUAL : You can control shutter speed manually. (1/60 ~ 1/120,000)
 - - - - : Shutter speed is fixed at 1/60 sec. (1/50 sec.)

▷ SHUTTER continued

 **NOTE**

- When using a DC lens, set the shutter mode to A.FLK if color rolling occurs.
- When the SHUTTER is set to ESC after selecting Internal Synchronization Type, the picture may become unstable if the camera faces a bright fluorescent light. Therefore, take care when choosing the installation position.
- When the SHUTTER is set to MANUAL or A.FLK mode, SENS-UP will be disabled.
- Set the shutter mode to - - - if color rolling occurs.

- ▶ AGC (AUTO GAIN CONTROL) : The higher the gain level, the brighter the screen, but the higher the noise.
 - OFF : Deactivates the AGC function.
 - LOW : Allows automatic gain control from 5.3dB to 32dB.
 - HIGH : Allows automatic gain control from 5.3dB to 37dB.
- ▶ SENS-UP : When it is night or dark, the camera automatically detects the light level and maintains a clear picture if this mode is activated.
 - OFF : Deactivates the SENS-UP function.
 - AUTO : Activates the SENS-UP function.

LIMIT	
▶ AUTO	X2
Press SET to Return	

▶ RETURN : Select this to save the changes in the EXPOSURE menu and return to the SETUP menu.

NOTE

- If you press the SET button in 'AUTO' mode, you can adjust brightness by increasing or decreasing the shutter speed. (x2 ~x512)
- Note that the higher the zoom level, the brighter the screen, but the more likely it is that an after-image will appear.
- Although noise, spots and whitish symptoms may occur in SENS-UP operation when the zoom level is increased, this is normal.

■ SSSDR (Super Dynamic Range)

SSDR illuminates darker areas of an image while retaining the same light level for brighter areas to even out the overall brightness of images with high contrast between bright and dark areas.

MAIN SETUP	
1. LENS	DC ↵
2. EXPOSURE	↵
▶ 3. SSSDR	ON
4. WHITE BAL	ATW
5. BACKLIGHT	OFF

1. When the SETUP menu screen is displayed, select 'SSDR' by using the Up and Down buttons so that the arrow indicates 'SSDR'.
2. Turn on by using the Left/Right buttons and press SETUP to change the SSSDR level in the sub menu according to the contrast between bright and dark areas.

SSDR SETUP	
▶ LEVEL	* 8
Press SET to Return	



SSDR OFF



SSDR ON

■ White Balance control

Use the White Balance Function to adjust the screen color.

1. When the SETUP menu screen is displayed, select 'WHITE BAL' by using the Up and Down buttons so that the arrow indicates 'WHITE BAL'.
2. Select a desired mode using the Left and Right buttons.

MAIN SETUP	
1. LENS	DC ←
2. EXPOSURE ←	
3. SDR	ON
▶ 4. WHITE BAL	ATW
5. BACKLIGHT	OFF

Select one of the following 5 modes, as appropriate for your purpose.

- ▶ ATW : Select this when the color temperature is between 1,700°K and 11,000°K.
- ▶ OUTDOOR : Select this when the color temperature is between 1,700°K and 11,000°K.
(sodium light inclusion)
- ▶ INDOOR : Select this when the color temperature is between 4,500°K and 8,500°K.
- ▶ MANUAL : Select this to fine-tune White Balance manually. Set White Balance first by using the ATW or AWC mode. After that switch to MANUAL mode, fine-tune the White Balance and then press the SET button.
- ▶ AWC → SET : To fine the optimal luminance level for the current environment, point the camera towards a sheet of white paper and press the Function Setup switch. If the environment changes, readjust it.

NOTE

- White Balance may not work properly under the following conditions. In this case select the AWC mode.
 1. When the color temperature of the environment surrounding the subject is out of the control range (ie. clear sky or sunset).
 2. When the ambient illumination of the subject is dim.
 3. If the camera is directed towards a fluorescent light or is installed in a place where illumination changes dramatically, the White Balance operation may become unstable.

■ BLC (Back Light Compensation)

1. When the SETUP menu screen is displayed, select 'BACKLIGHT' by using the Up and Down buttons so that the arrow indicates 'BACKLIGHT'.

MAIN SETUP	
1. LENS	DC ←
2. EXPOSURE ←	
3. SDR	ON
4. WHITE BAL	ATW
▶ 5. BACKLIGHT	OFF

2. Select a desired mode using the Left and Right buttons depending on the camera purpose.

- ▶ USER BLC : Enables a user to select a desired area on a picture and view that area more clearly.
 - LEVEL : Adjust level of the HLC function.
 - TOP/BOTTOM/LEFT/RIGHT : Adjust the area to be enhanced.

BLC SETUP	
▶ 1. LEVEL	MIDDLE
2. TOP	* 25
3. DOWN	* 90
4. LEFT	* 70
5. RIGHT	* 150
6. RETURN ←	
Press SET to Return	



BLC ON



BLC OFF

- ▶ HLC (High Light Compensation) : If the scene contains extremely bright light areas such as from car headlight, the light can mask out much of the on-screen detail. Use HLC feature to remove these exceptionally bright light areas to allow detail such as car license plate number to become visible.
 - LEVEL : Adjust level of the HLC function.
 - LIMIT : Enable to change the operating condition.
 - MASK COLOR/TONE : Change the color / brightness of the masking area.
(Black, Red, Blue, Cyan, Magenta)
 - TOP/BOTTOM/LEFT/RIGHT : Adjust the area to be enhanced.

HLC SETUP	
▶ 1. LEVEL	MIDDLE
2. LIMIT	NIGHT ONLY
3. MASK COLOR	BLACK
4. MASK TONE	* 5
5. TOP	* 10
6. BOTTOM	* 105
7. LEFT	* 10
8. RIGHT	* 210
9. RETURN	←

▷ HLC continued



HLC OFF



HLC ON

▶ OFF : Not being used.

3. Select a desired mode using the Left and Right buttons and press the SET button.

▶ BLC : Select 'BLC' to adjust the area to be enhanced then adjust the level.

▶ HLC : Enable the user to change the level limit, mask color/tone and area.

BLC SETUP	
▶ LEVEL	MIDDLE
TOP	* 27
DOWN	* 82
LEFT	* 42
RIGHT	* 126
Press SET to Return	

BLC SETUP	
▶ LEVEL	MIDDLE
LIMIT	NIGHT ONLY
MASK COLOR	BLACK
MASK TONE	* 5
TOP	* 38
BOTTOM	* 109
LEFT	* 54
RIGHT	* 121
Press SET to Return	

NOTE

- For effective license plate observation, it needs minimum illumination and fast shutter speed more than 1/200 sec.
- Because there can be a difference in the effectiveness of HLC according to the amount of light area in the screen, optimize the installation angle for the best HLC performance.
- When dark, the HLC is only activated when a bright light exceeding a specific size in NIGHT ONLY mode.
- The HLC is not activated in day light or when bright light is not present at night in NIGHT ONLY mode.

■ DNR3

This function reduces the background noise in a low luminance environment.

1. When the SETUP menu screen is displayed, select 'DNR3' by using the Up and Down buttons so that the arrow indicates 'DNR3'.

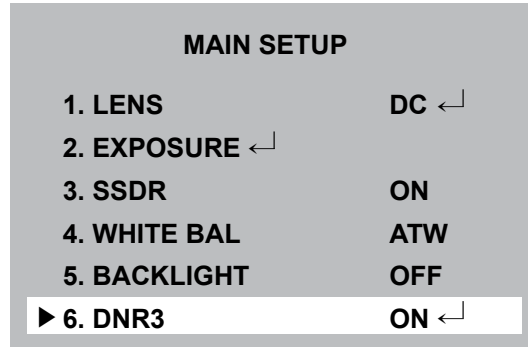

2. Select a desired mode using the Left and Right buttons.

- ▶ OFF : Deactivates DNR3. Noise is not reduced.
- ▶ ON : Activates DNR3 so that noise is reduced.

3. Set the DNR3 mode to 'ON' and press the SET button. Then you can adjust the noise reduction level.

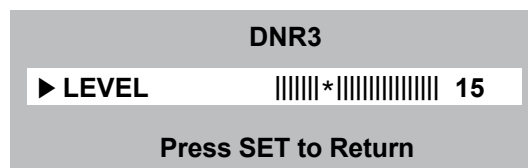

NOTE

- You cannot set the DNR3 to 'ON' or 'OFF' when the AGC mode of the EXPOSURE menu is 'OFF'.
- When adjusting the noise reduction level in DNR3 mode, remember that the higher the level is set, the greater the reduction in noise level, as will the brightness of the image.

■ Day/Night

You can display pictures in color or black and white.

1. When the SETUP menu screen is displayed, select 'DAY/NIGHT' by using the Up and Down buttons so that the arrow indicates 'DAY/NIGHT'.

MAIN SETUP	
1. LENS	DC ↵
2. EXPOSURE ↵	
3. SSSDR	ON
4. WHITE BAL	ATW
5. BACKLIGHT	OFF
6. DNR3	ON ↵
▶ 7. DAY/NIGHT	COLOR

2. Select a desired mode using the Left and Right buttons according to the picture display you want.
 - ▶ EXTERN : This mode allows you to apply a desired filter to external signals.
 - ▶ COLOR : The picture is always displayed in color.
 - ▶ B/W : The picture is always displayed in black and white.
You can turn on or off the burst signal on B/W mode.
 - ▶ AUTO : The mode is switched to 'COLOR' in a normal environment, but switches to 'B/W' mode when ambient illumination is low. To set up the switching time for AUTO mode, press the SET button.
You can turn on or off the burst signal on B/W mode.

AUTO SETUP	
▶ 1. BURST MODE	ON
2. COLOR→B/W	
DURATION	FAST
DWELL TIME	5 SEC
3. B/W→COLOR	
DURATION	FAST
DWELL TIME	10 SEC
4. RETURN ↵	

- BURST MODE : You can turn on or off the burst signal on B/W mode.
- DURATION : You can select the brightness level at which the camera switches from day to night mode.
- DWELL TIME : You can select the duration the camera changes from day to night mode and night to day.

NOTE

- When using a video Auto Iris Lens, if you set the lens level to low, automatic switching between Color and Black & White may not occur.
- When AGC in the EXPOSURE menu is 'OFF', '-' mode operates as like selecting 'COLOR' mode, and 'AUTO' mode can not be selected.

■ Special

1. When the SETUP menu screen is displayed, select 'SPECIAL' by using the Up and Down buttons so that the arrow indicates 'SPECIAL'. Press SETUP to enter the 'SPECIAL' menu.

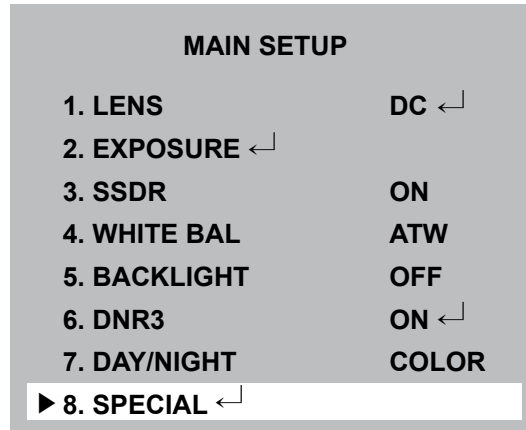

2. Select a desired mode using the Up and Down buttons.

▶ IMAGE ADJ. :

1) When the SETUP menu screen is displayed, select 'IMAGE ADJ.' by using the Up and Down buttons so that the arrow indicates 'IMAGE ADJ.'. Press SETUP to enter 'IMAGE ADJ.'.

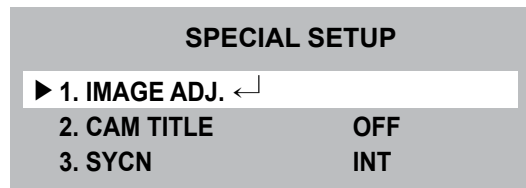

2) Select a desired mode using the Up and Down buttons.

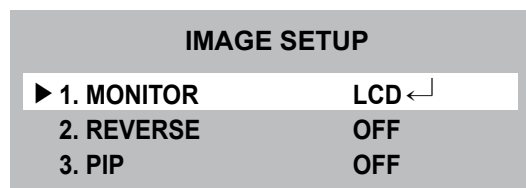

- MONITOR : Change the settings value of video that is appropriate to your monitor.
 - LCD : Select this menu item when using a LCD monitor.
 - CRT : Select this menu item when using a CRT monitor.
 - USER : Use this menu item when using a monitor other than standard ones. You can change the gamma, PED level, and color gain in the sub menus.
- REVERSE : You can reverse the picture.
 - OFF : Picture will not be reversed.
 - H-REV : Horizontal flip.
 - V-REV : Vertical flip.
 - HV-REV : Both Horizontal and Vertical flip.

- PIP (Picture-in-Picture) : Displays a full size image along with the thumbnail to provide more detailed information. The position of the thumbnail is adjustable.
- D-ZOOM : You can use a digital zoom of x1 ~ x16.
- FONT COLOR : You can change the OSD font color.
- LANGUAGE : You can select the menu language.
 - NTSC : Korean, English, French, Spanish, Japanese, Portuguese.
 - PAL : English, Chinese, German, Italian, French, Spanish, Russian, Serbian, Swedish, Danish, Turkish, Portuguese.
- SHARPNESS : As you increase this value, the picture outline becomes stronger and clearer. Adjust this value appropriately depending on the sharpness of the picture.
- RETURN : Select this to save the settings for the IMAGE ADJ. menu and to return to the SETUP menu.

NOTE

- When the REVERSE mode is enabled, the text on the screen will not flip.
- If you increase the SHARPNESS level too high, the picture may become distorted or noise may appear.

- ▶ CAM TITLE : If you enter a title, the title will appear on the monitor.
- 1) If the SPECIAL menu screen is displayed, use the Up and Down buttons so that the arrow indicates 'CAM TITLE'.
 - 2) Set it to 'ON' by using the Left and Right buttons.
 - 3) Press the SET button.
 - 4) Use the 4 direction buttons to move to a desired letter and select the letter by pressing the SET button. Repeat this to enter multiple letters. You can enter up to 15 letters.
 - 5) Enter a title, move the cursor to 'POS' and press the SET button. The entered title appears on the screen. Select the position to display the title on the screen by using the 4 direction buttons and press the SET button. When the position is determined, select 'END' and press the SET button to return to the SPECIAL menu.

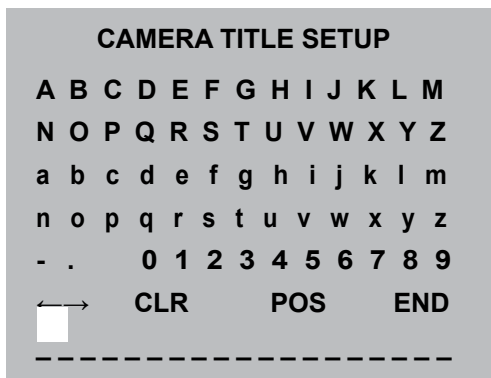

NOTE

- When the CAM TITLE menu is 'OFF', on title will be displayed on the monitor screen even if you enter one.
- Only English is available in this mode.
- If you move the cursor to CLR and press the SET button, all the letters are deleted. To edit a letter, change the cursor to the bottom left arrow and press the SET button. Move the cursor over the letter to be edited, move the cursor to the letter to be inserted and then press the SET button.

- ▶ **SYNC** : In areas where the supply is at 60Hz, you can synchronize the output phase of multiple cameras using the power synchronization function (Line-Lock) without using a synchronization signal generator.
 - INT : Internal Synchronization Type.
 - L/L : Power Synchronization Type, Line-Lock.
 - Press the Function Setup switch.
 - You can select a desired phase from 0 to 359 when select 'PHASE'.

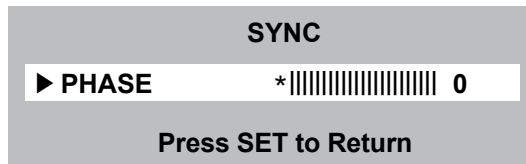

NOTE

- When using AC power at 60Hz frequency, you can use the L/L type synchronization.
- When the power is DC 12V, or when VPS is set to ON, the SYNC menu is fixed to the 'INT' mode.

- ▶ **MOTION** : You can monitor activity more efficiently with this feature by means of an outlined box around moving objects, and the words 'MOTION DETECTED' appearing on screen.
 - MOTION : Enable or disable the motion detection feature.
 - OFF : Disables motion detection.
 - DETECTION : Activates motion detection.
 - DETECT BOX : Outlines an object on the screen in a box when movement matches a custom motion type.
 - ALARM OUT : Releases a signal from the MD Output Terminal of the camera when an object's movement matches a custom motion type.
 - DETECT AREA : Defines the motion detection area.

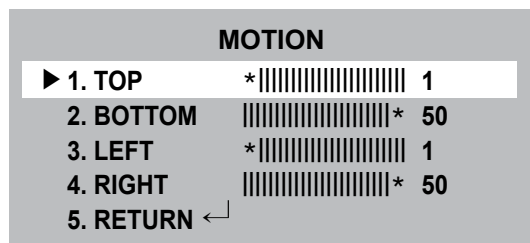
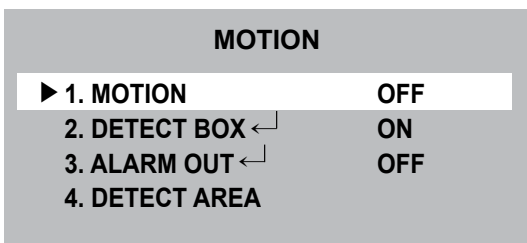

▷ MOTION DET continued

MASK AREA		
▶ 1. AREA		AREA1
2. MODE		OFF
3. TOP	*	30
4. BOTTOM	*	110
5. LEFT	*	25
6. RIGHT	*	110
7. RETURN	←↵	

- MASK AREA : Specify a detection exception area to mask. Select a mask area number and specify the size and position.
 - AREA : Select up to 4 areas.
 - MODE : Turn the selected area ON or OFF.
 - TOP/BOTTOM/LEFT/RIGHT : Adjust the size and position of the selected area.
 - RETURN : Select this to save the mask area menu setting, and return to the intelligence menu.
- SENSITIVITY : Set the sensitivity of the motion detection. The lower the level means the higher the sensitivity.
- DETECT SIZE : Selects an object size to detection on the screen. The higher the lwwl means the larger the detection size.
- RETURN : Select this to save the motion menu settings and return to the special menu.

▶ PRIVACY : Mask an area you want to hide on the screen.

1) When the SPECIAL menu screen is displayed, press the Up and Down buttons so that the arrow indicates 'PRIVACY'.

PRIVACY AREA SETUP		
▶ 1. AREA		AREA1
2. MODE		OFF
3. MASK COLOR		WHITE
4. TRANSPARENCY		OFF
5. SEL POS		L_TOP
6. XPOS	*	10
7. YPOS	*	10
8. RETURN	←↵	

2) Set up the mode using the 4 direction buttons.

- AREA SEL : Select up to 12 PRIVACY areas.
- MODE : Turn the selected area ON or OFF.
- MASK COLOR : Determines area color. Select Green, Red, Blue, Black, White, Gray.
- TRANSPARENCY : Add or remove transparency from the masked area.
- SELECT POS : Adjust the size and position of the selected area.
- RETURN : Select this to save the PRIVACY menu settings and return to the SPECIAL menu.

- ▶ DIS (Digital Image Stabilizer) : This function mitigates any picture movement due to external factors such as wind.

NOTE

- As the DIS function uses the digital zoom, the camera's resolution will decrease.
- DIS doesn't operate when background illumination is low, or then object pattern is monotonic (such as a white wall, or sky).

- ▶ PROFILE : Profile is a set of predefined settings for various conditions.
 - 1) When the SPECIAL menu screen is displayed, press the Up and Down buttons so that the arrow indicates 'PROFILE'.
 - 2) Set up the mode using the 4 direction buttons.

	BASIC	DAY/NIGHT	BACKLIGHT	ITS	INDOOR	USER
SHUTTER	---	---	---	MANUAL(1/250)	A.FLK	-
GAIN	HIGH	HIGH	HIGH	HIGH	HIGH	-
WHITE BAL	ATW	ATW	ATW	OUTDOOR	INDOOR	-
BACKLIGHT	OFF	OFF	USER BLC	OFF	OFF	-
SSNR3	ON	ON	ON	ON	ON	-
DAY/NIGHT	AUTO	AUTO	AUTO	AUTO	AUTO	-

- BASIC : Adjusts the settings for the most commonly found environment.
- DAY/NIGHT : Optimizes settings for the respective day/night conditions.
- BACKLIGHT : Optimizes settings so you can distinguish the object from the background in a severe backlighting condition.
- ITS : Adjusts settings so you can easily check traffic conditions.
- INDOOR : Adjusts the settings for regular indoor lighting conditions.
- USER : Automatically configures the camera to your custom settings.
 - Select custom for simple setup mode.
 - Configure the menu options to your custom settings.
 - The settings are automatically saved as custom mode.
 - Profile user mode doesn't initialize when menu resets.
- ▶ RETURN : Select this to save SPECIAL menu settings and return to the MAIN SETUP menu.

■ Exit

Select a desired EXIT mode using the Left and Right buttons depending on the camera purpose.

- ▶ SAVE : Save the current settings and exit the MAIN SETUP menu.
- ▶ NOT SAVE : Do not save the current settings and exit the MAIN SETUP menu.
- ▶ RESET : Resets the camera settings to the factory defaults. Language and monitor settings are not initialized.

■ Trouble Shooting

PROBLEM	POSSIBLE CAUSE
Nothing appears on the screen.	☞ Check the power cable, power supply output and video connection between the camera and monitor.
The image on the screen is dim.	☞ Are the camera lens or the lens glass dirty? Clean the lens / glass with a soft clean cloth. ☞ Adjust the monitor controls, as required. ☞ If the camera is facing a very strong light, change the camera position. ☞ Adjust the lens focus.
The image on the screen is dark.	☞ Adjust the contrast control of the monitor. ☞ If there is an intermediate device, correctly set the 75Ω/Hi-z.
The camera is not working properly and the surface of the camera is hot.	☞ Check the camera is correctly connected to an appropriate regulated power source.
Motion Detection is not activated.	☞ Has MOTION DET been set to ON in the menu? ☞ Has MD AREA been properly defined?
The color of the picture is not correct.	☞ Check the settings in WHITE BALANCE menu.
The image on the screen flickers.	☞ Make sure that the camera isn't facing direct sunlight or fluorescent lighting. If necessary, change the camera position.
The SENS-UP does not work.	☞ Check that the AGC setting in the EXPOSURE menu is't set to OFF. ☞ Check the EXPOSURE menu and make sure SHUTTER is set to-----.

