

UM10300

User Manual OM6290 LCD Demo Board

Rev.1.0 — 8 August 2008

User manual

Document information

Info	Content
Keywords	LCD driver, segment driver, character driver, graphic driver, PCF8576D, PCF2119, PCF8531, PCA9633, ARM7, LPC2148, battery powered, USB
Abstract	<p>The OM6290 is a LCD driver evaluation board which can be used to demonstrate and evaluate three different types of LCD drivers: The PCF8576D is a segment driver, the PCF2119 a character driver and the PCF8531 a dot matrix driver. The NXP family of LCD drivers consists of these three different types, with several type numbers for each type. From an application point of view, the type numbers within one type family are very similar and also software can be easily adapted.</p> <p>The board provides a starting point for applications using an NXP LCD driver, both from the hardware and software point of view.</p>

Revision history

Rev	Date	Description
01	20080808	Initial version

Contact information

For additional information, please visit: <http://www.nxp.com>

For sales office addresses, please send an email to: salesaddresses@nxp.com

1. Introduction

This User Manual describes the OM6290 LCD Demo board. This board was developed in order to provide a tool for application engineers and development engineers wishing to try and evaluate the possibilities of some of our LCD driver IC's and to get hands-on experience with writing code for these drivers. Code written using this board can be used in the final application which enables rapid prototyping. The board can also serve as an example for the hardware related aspects of a design using NXP LCD drivers.

Features:

- Demonstrates how to use NXP LCD drivers
- Contains three displays controlled by I²C LCD drivers:
 - Segment display driven by segment driver PCF8576DT, TSSOP56
 - Character display with character driver PCF2119S (COG, Chip On Glass)
 - 128 * 34 dot matrix display with graphic driver PCF8531 (COG)
- PCA9633 I²C bus controlled LED driver for back light
- ARM7 based NXP microcontroller LPC2148 with 512 KB flash memory
- User modifiable firmware, In-System/In-Application Programming (ISP/IAP) via UART
- USB2.0 compliant interface
- JTAG interface
- I²C interface
- Unused pins of microcontroller available on pin strip
- Power supply using 9V battery (stand alone) or via USB
- Box contents:
 - OM6290 LCD driver evaluation board
 - USB2.0 cable
 - 9V battery

The three drivers all include an I²C interface and can be programmed via the onboard NXP micro controller LPC2148 which is built around an ARM7 core.

The PCF8576D is a Segment Driver and has a lot in common with other NXP Segment Drivers such as PCF8532 (4 x 160 segments), PCF8533 (4 x 80), PCF8534A (4 x 60), PCF8562 (4 x 32) and PCF8566 (4 x 24).

The PCF2119 is a Character Driver and has a lot in common with other members of the family like PCF2113 and PCF2116.

The PCF8531 is a Graphic Driver (Row/Column) and the NXP family of Graphic Drivers contains some other types like PCF8535. Experiences gained with the onboard drivers can easily be used for working with the other drivers belonging to the same family.

The 12nc of the OM6290 board is 9352 861 74598.

2. Board description and layout

Below the top view of the board is given. LCD3 is the large display on the left. For this display a backlight is used which is controlled by the PCA9633 LED driver. On the top right LCD2 is present and the smaller display below LCD2 is LCD1.

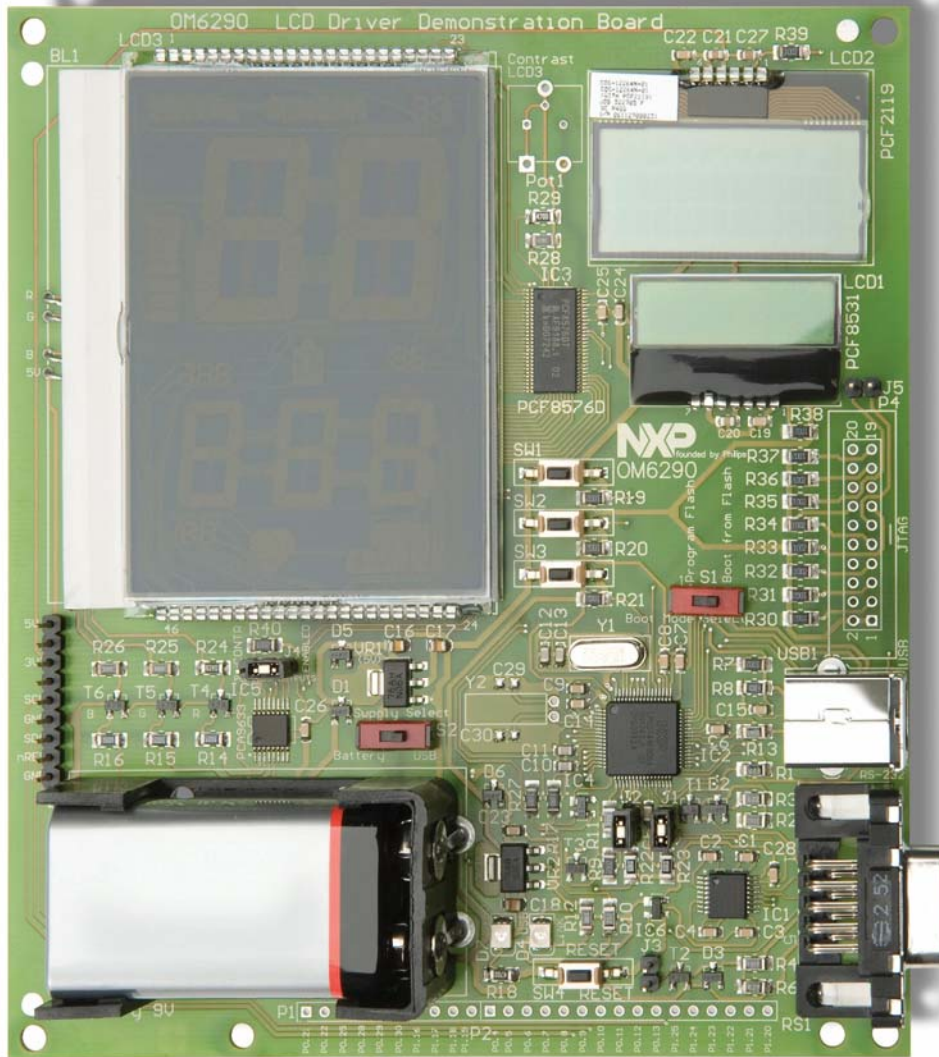

Fig 1. Top view of LCD Demoboard

For best optical performance, remove the protective foils from the three displays. In order for the board to work standalone, jumpers J1 and J2 (I²C) must be placed as well as jumper J4. Default position for J4 is 'Enabled', enabling LED driver PCA9633 (IC5).

2.1 Switches

Three switches are present next to the large display LCD3. SW1 is used to select the predefined patterns/text present in the firmware for display on LCD1. SW2 has the same function but then for LCD2 and SW3 selects the pattern that will be displayed on LCD3. Furthermore SW3 can be used to select some lighting modes of backlight BL1 which is mounted under LCD3.

SW4 is located near the bottom of the board and is the reset switch. At start up all displays will display some text and when SW1 or SW2 or SW3 is pressed, the displayed text/pattern on the related display will change.

Switch S1 can be used to select "Program Internal Flash" of the LPC2148 in order to program modified firmware, or to let the LPC2148 boot from its internal flash.

The OM6290 is a USB-powered device. Alternatively the board can be powered using a standard 9V (6LR61 / PP3) battery. A battery holder is present on the board and switch S2, located between the battery holder and LCD3, can be used to select either USB-power or battery power.

2.2 LED indicators

The board contains two LED indicators. LED D7 (green) indicates that +5V is present on the board, supplied either via USB or via the +9V battery. The +3V3 is derived from +5V.

LED D4 (orange/red, labeled LINK) is on when firmware has been loaded into the flash memory. If S1 is in position "Program Flash" and the board is reset, D4 goes off and the board is ready to be flashed. After programming the board, move S1 to "Boot from Flash" and reset the board by pressing SW4 "RESET". D4 will turn on now.

2.3 Jumpers

The board contains five jumpers.

- J1 (SDA) and J2 (SCL), positioned just below the micro controller, allow disconnecting the I²C bus on the board from the LPC2148 I²C interface. When jumpers J1 and J2 are lifted, the I²C connections to the micro controller are disconnected and the display drivers can be programmed via any other micro controller or application with I²C-interface. The I²C signals SDA and SCL as well as GND and 3V3 and 5V are available on the pin strip P3 just above the 9V battery.
- J3, near the bottom of the board, can usually be left open. If present it allows resetting the microcontroller via serial interface RS1, required for ISP programming.
- J4 is used to enable/disable the outputs of the PCA9633 LED driver which is used for backlight BL1. Default position is enabled. If it is put in position 'uCONTR' it is possible to use the firmware to disable and enable the outputs.
- J5 is used to enable the JTAG interface. In this case also connector P4 must be mounted on the board. This would be useful to explore the LPC2148 more indepth.

2.4 Connectors

On the left below LCD3 a pin strip P3 is available which carries the following signals: 5V, 3V3, SCL, GND, SDA and nRES. The latter is connected to the reset circuit IC6 and by making nRES LOW, a defined reset signal is generated.

On the right side of the board a USB connector has been provided. At the time of writing the first revision of this manual the only purpose of the USB connector is to offer the option of powering the board via USB. Future updates of the firmware which would also enable data communication between the LCD driver ICs and a GUI which then would run on a PC, are under consideration.

The serial interface RS1 (UART) below the USB connector is used for updating the firmware in the microcontroller.

2.5 Reserved components

The board layout includes a few components which are not directly necessary for the primary purpose of the board which is providing a hands-on tool to work with the three different types of NXP LCD drivers. Therefore these components are not mounted. However, in some scenario's it may be desired to explore more of the options of the on-board microcontroller. Therefore three optional areas may be mounted by the user of the board in order to add extra functionality.

1. Real Time Clock of LPC2148: By mounting a 32.768 kHz crystal at position Y2 as well as two capacitors at positions C29, C30 the internal RTC can be used. The values of C29 and C30 depend on the crystal used. A crystal for an RTC is designed to operate with a certain load capacitance C_L . A common value for the required load capacitance of such a crystal is 12.5 pF. Seen from the crystal C29 and C30 are in series. Taking into account parasitic capacitances as well, C29 and C30 will have to be 22 pF or 25 pF if a 12.5 pF crystal is used.
2. JTAG interface: On the right side of the board under LCD1, space is provided for a JTAG connector. This is a 20-pin header with pitch of 2.54 mm. The required pull-up resistors are already mounted.
3. Pin strips P1 and P2 near the bottom edge of the board. If a pin strip is soldered on the board at this position, all unused pins of the microcontroller are accessible.

If mounted, exercise caution not to overload these signal lines !

Besides these microcontroller related items, another option is to remove resistor R29 (470 Ω) and mount potentiometer Pot1 (4k7) instead. This enables adjustment of the contrast of display LCD3. The location of these components is between LCD2 and LCD3.

2.6 Hardware requirements

In order to be able to modify the firmware of the OM6290 Demo Board you need:

- The OM6290 Demo Board
- An IBM-compatible PC with an unused USB port to supply power to the board (alternatively via a battery) and an unused RS232 COM port for Flash In-System Programming (ISP) via the Serial Interface.
- 70 Megabytes free hard disk space (depending on the IDE used)
- 128 Megabytes of RAM
- A serial cable, 9-pin male to 9-pin female, no longer than 10ft/3m, wired one-to-one, in order to program new firmware on the OM6290 board, using the FlashMagic tool, see below.

2.7 Software requirements

In order to be able to modify or write code the following software is required:

- Windows Operating System (Windows 2000, Windows XP or Windows Vista);
- A development tool for ARM7 cores providing source code editing, compiling, linking and debugging. A good (free) option is the evaluation version of the Keil Microcontroller Development Kit (MDK-ARM). At the time of writing the latest is mdk322a, which is Version 3.22 (or use later versions as they become available). This can be downloaded at <https://www.keil.com/demo/eval/arm.htm> (registration required). The RealView MDK includes μ Vision (Integrated Development Environment, Debugger and Simulator) and RealView compilation tools for C/C++ and linker. For more information see <http://www.keil.com/arm/>;
- Programming utility FlashMagic to flash the .hex file into the LPC2148, see <http://www.flashmagictool.com/>. This is freeware.

For more information about how to use these tools refer to chapter 5.

2.8 Modes of operation

The board can be used in two different modes:

1. stand-alone mode; after power-up pre-defined patterns/texts are displayed on the three displays. Using switches SW1, SW2 and SW3 it is possible to select various patterns. The firmware can be modified using the appropriate tools;
2. I²C remote mode; jumpers on the board (J1 and J2) can be removed such that the on-board microcontroller's I²C bus is no longer connected to the display drivers. Via pin strip P3 all display drivers can be accessed directly from an external I²C-bus. This allows to access the display drivers on the board from any other application via I²C using a microcontroller residing on a separate board.

Note: the following describes the operation of the version 1 software. Please refer to the Quick Start Guide that corresponds to your version of software for operating details.

When the board is used in stand-alone mode (Software version 1.10) it behaves as follows. After power on, LCD3 is dark, the back light is off. LCD2 shows a welcome message and after a few seconds shows the message "Please press SW1, 2 or 3". With early versions LCD1 shows the NXP logo at startup. Starting from firmware version v1.1

LCD1 shows three lines of text, with in the right bottom corner the version number. Upon pressing any of the switches SW1, SW2 or SW3 the backlight of LCD3 turns on.

LCD1.

Power on: The NXP logo is displayed. Starting from v1.1, the following text is displayed over three lines,:

“NXP founded by Philips”

“For the latest updates”

“visit www.nxp.com”

When pressing SW1 the displayed pattern changes to the NXP logo and subsequent operation of SW1 results in alternating between the NXP logo, displaying the type number of the driver (PCF8531) and displaying a face.

LCD2.

At power on the message “ * welcome * ” enters the upper line, shifting from right to left. This shows the ‘display shift’ feature. After that the message “Please press SW1, 2 or 3” appears. When SW2 is pressed, the display shows “NXP Insightful”. Pressing once more results in “NXP Inventive”. Consecutive pressing of SW2 results in cycling through texts “NXP Engaging”, “NXP Excellence”, “USE SW3 FOR BACKLIGHT” and “NXP PCF2119s”. Hereafter the cycle starts again.

When the message “USE SW3 FOR BACKLIGHT” is displayed, SW3 does not control what is being displayed on LCD3, but instead changes the backlight colour and/or intensity when pressed. Also note that only when this message is displayed, a cursor is seen blinking on the right of the message. This demonstrates the feature ‘cursor blink’ of the PCF2119.

LCD3.

Power on: The display is blank, then after a few seconds the counter read “000”. Pressing SW1 – SW3 increments the count. Pressing SW3 once results in the text “CH” being displayed. Operating SW3 a 2nd time results in all segments being lit up. When now SW3 is pressed a 3rd time, it restarts the cycle with a blank display again.

3. The LCD Drivers

The board contains three different types of LCD drivers. This chapter describes the used drivers on the board. The key values of NXP LCD drivers are listed below.

- Segment drivers:
 - High segment count, leading in number of segments supported per single device; 60 x 4, 80 x 4, 160 x 4;
 - AEC-Q100 automotive qualification.
- Character drivers:
 - Separate icon row for versatile usage.
- Graphic drivers (dot matrix):

- Resolutions that are not common in the market:
34 x 128, 65 x 133, 80 x 128.

3.1 Segment Driver PCF8576D

3.1.1 General Description

The PCF8576D is a peripheral device which interfaces to almost any Liquid Crystal Display (LCD) with low multiplex rates. It generates the drive signals for any static or multiplexed LCD containing up to four backplanes and up to 40 segments. It can be easily cascaded for larger LCD applications. The PCF8576D is compatible with most microprocessors / microcontrollers and communicates via a two-line bidirectional I²C-bus. Communication overheads are minimized by a display RAM with auto-incremented addressing, by hardware sub-addressing and by display memory switching (static and duplex drive modes). It has a lot in common with other NXP Segment Drivers such as PCF8532 (4 x 160 segments), PCF8533 (4 x 80 segments), PCF8534A (4 x 60), PCF8562 (4 x 32) and PCF8566 (4 x 24).

3.1.2 Features

- single chip LCD controller / driver
- selectable backplane drive configuration: static or 2 / 3 / 4 backplane multiplexing
- selectable display bias configuration: static, 1/2 or 1/3
- internal LCD bias generation with voltage-follower buffers
- 40 segment drives:
 - up to twenty 8-segment numeric characters
 - up to ten 15-segment alphanumeric characters
 - any graphics of up to 160 elements
- 40 x 4-bit RAM for display data storage
- auto-incremented display data loading across device subaddress boundaries
- display memory bank switching in static and duplex drive modes
- versatile blinking modes
- independent supplies possible for LCD and logic voltages
- wide power supply range: from 1.8 to 5.5 V
- wide logic LCD supply range:
 - from 2.5 V for low-threshold LCDs
 - up to 6.5 V for guest-host LCDs and high-threshold (automobile) TN LCDs
- low power consumption
- 400 kHz I²C-bus interface
- compatible with 4, 8 or 16-bit microprocessors or microcontrollers
- may be cascaded for large LCD applications (up to 2560 elements possible)
- no external components
- compatible with chip-on-glass and chip-on-board technology

- manufactured in silicon gate CMOS process
- AEC-Q100 compliant (TQFP64).

3.1.3 Block diagram

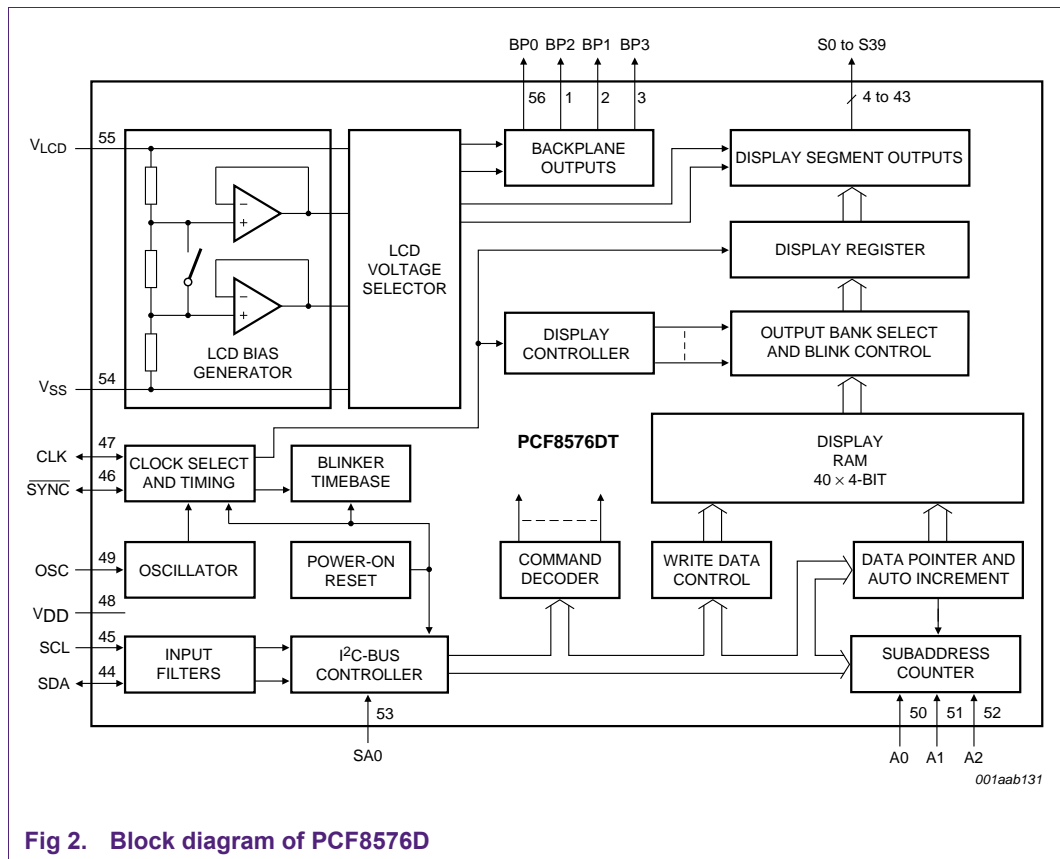

Fig 2. Block diagram of PCF8576D

3.2 Character Driver PCF2119

3.2.1 General Description

The PCF2119x is a low power CMOS LCD controller and driver, designed to drive a dot matrix LCD display of 2-line by 16 or 1-line by 32 characters with 5 x 8 dot format. All necessary functions for the display are provided in a single chip, including on-chip temperature compensated generation of LCD bias voltages, resulting in a minimum of external components and lower system current consumption. The PCF2119x interfaces to most microcontrollers via a 4 or 8-bit bus or via the 2-wire I²C-bus. The chip contains a character generator and displays alphanumeric and kana (Japanese) characters. The letter 'x' in PCF2119x characterizes the built-in character set. Various character sets can be manufactured on request. The character set of the PCF2119 on the demo board is 'S'. A similar device is the PCF2113 (2-line by 12 or 1-line by 24 characters + 120 icons).

3.2.2 Features

- Single-chip LCD controller/driver
- 2-line display of up to 16 characters + 160 icons, or
1-line display of up to 32 characters + 160 icons
- 5 x 7 character format plus cursor; 5 x 8 for kana (Japanese) and user defined symbols
- Icon mode: reduced current consumption while displaying icons only
- Icon blink function
- On-chip:
 - Configurable (4 times, 3 times or 2 times) voltage multiplier generating LCD supply voltage, independent of V_{DD} , programmable by instruction; Using an external supply is also possible
 - Programmable temperature compensation of on-chip generated V_{LCD} ; range: -0.16 to -0.24 %/K
 - Generation of intermediate LCD bias voltages
 - Oscillator requires no external components but using an external clock is also possible
- Display Data RAM: 80 characters
- Character Generator ROM: 240, 5 x 8 characters
- Character Generator RAM: 16, 5 x 8 characters; 4 characters used to drive 160 icons, 8 characters used if icon blink feature is used in application
- 4 or 8-bit parallel bus and 2-wire I²C-bus interface
- CMOS compatible
- 18 row and 80 column outputs
- Three multiplex rates; 1 : 18 (for normal operation), 1 : 9 (for single line operation) and 1 : 2 (for icon only mode)
- Uses common 11 code instruction set (extended)
- Logic supply voltage range, $V_{DD1} - V_{SS} = 1.5$ to 5.5 V (chip may be driven with two battery cells)
- Display supply voltage range, $V_{LCD} - V_{SS} = 2.2$ to 6.5 V
- HVgen supply voltage range, $V_{DD2} - V_{SS} = 2.2$ to 4 V and $V_{DD3} - V_{SS} = 2.2$ to 4 V
- Direct mode to save current consumption for icon mode and Mux 1 : 9 (depending on V_{DD2} value and LCD liquid properties)
- Very low current consumption (20 to 200 μ A):
 - Icon mode: <25 μ A
 - Power-down mode: <2 μ A.

3.2.3 Block diagram

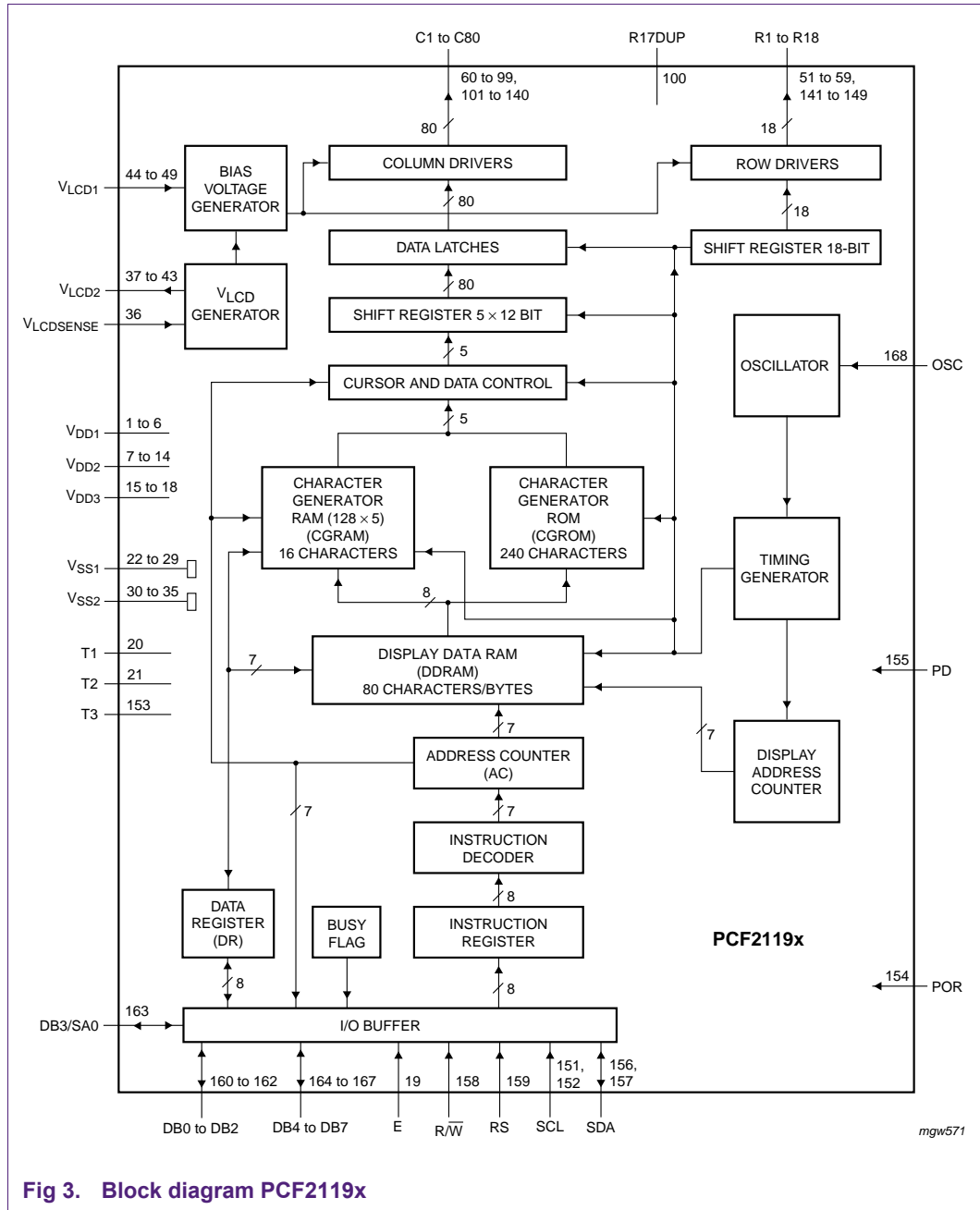

Fig 3. Block diagram PCF2119x

3.3 Graphic Driver PCF8531

3.3.1 General Description

The PCF8531 is a low power CMOS LCD row/column driver, designed to drive dot matrix graphic displays (32 rows x 128 columns) at multiplex rates of 1:17, 1:26 and 1:34. Furthermore, it can drive up to 128 icons. All necessary functions for the display are provided in a single chip, including on-chip generation of V_{LCD} and the LCD bias

voltages, resulting in a minimum of external components and low power consumption. The PCF8531 is compatible with most microcontrollers and communicates via a two-line bidirectional bus (I²C-bus). All inputs are CMOS compatible. Similar devices are PCF8535 (65 rows x 133 columns) and PCF8811 (80 rows x 128 columns).

Remark: The icon mode is used to reduce current consumption. When only icons are displayed, a much lower operating voltage (V_{LCD}) can be used and the switching frequency of the LCD outputs is reduced. In most applications it is possible to use V_{DD} as V_{LCD} .

3.3.2 Features

- Single-chip LCD controller/driver
- 34 row and 128 column outputs
- Display data RAM 34 · 128 bits
- 128 icons (last row is used for icons)
- Fast mode I²C-bus interface (400 kbit/s)
- Software selectable multiplex rates: 1:17, 1:26 and 1:34
- Icon mode with Mux rate 1:2:
 - Featuring reduced current consumption while displaying icons only
- On-chip:
 - Generation of V_{LCD} (external supply also possible)
 - Selectable linear temperature compensation
 - Oscillator requires no external components (external clock also possible)
 - Generation of intermediate LCD bias voltages
 - Power-on reset.
- No external components required
- Software selectable bias configuration
- Logic supply voltage range V_{DD1} to V_{SS1} is 1.8 to 5.5 V
- Supply voltage range for on-chip voltage generator V_{DD2} and V_{DD3} to V_{SS1} to V_{SS2} is 2.5 to 4.5 V
- Display supply voltage range V_{LCD} to V_{SS}
 - Normal mode 4 to 9 V
 - Icon mode 3 to 9 V
- Low power consumption, suitable for battery operated systems
- CMOS compatible inputs
- Manufactured in silicon gate CMOS process.

3.3.3 Block diagram

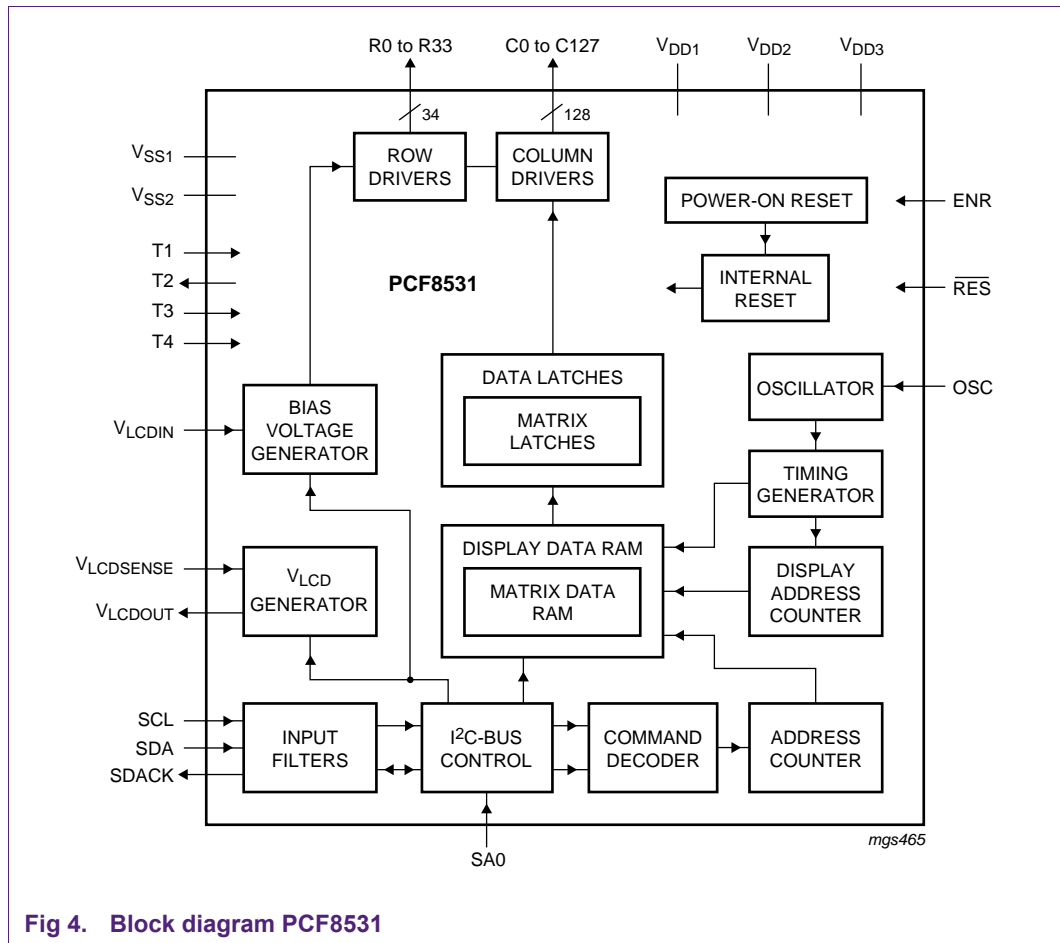

Fig 4. Block diagram PCF8531

4. The onboard microcontroller

The microcontroller chosen for this board is the LPC2148 which is a member of the NXP ARM7 controller family. This microcontroller is based on a 16-bit/32-bit ARM7TDMI-S CPU with real-time emulation and embedded trace support and embedded high-speed flash memory of 512 kB. A 128-bit wide memory interface and a unique accelerator architecture enable 32-bit code execution at the maximum clock rate. For critical code size applications, the alternative 16-bit Thumb mode reduces code by more than 30 % with minimal performance penalty.

The LPC2148 is highly over specified for the demo application program. This allows the user to program the MCU with much more advanced applications. Also, it has some very convenient features like an integrated USB interface and the possibility to program new firmware versions in the embedded flash using In-circuit Serial Programming via the PC's serial port. This enables modifications in the firmware to be quickly evaluated.

Features include:

- 60-MHz, 32-bit ARM7TDMI-S with AHB/APB interfaces
- 512 KB of ISP/IAP Flash
- 40 KB of SRAM
- Very fast Flash programming via on-chip boot loader
- USB 2.0 full-speed (12 Mbps) device
- Two 10-bit A/D converters, providing 14 analog inputs
- 10-bit D/A converter
- Multiple serial interfaces: two I²C, two UARTs, one SPI, and one SSP
- Two 32-bit timers
- Real-time clock and Watchdog timer
- 45 Fast I/O pins (5-V tolerant) with up to 15-MHz switching rate
- Single 3.3-V supply
- LQFP64 package (10 x 10 x 1.4 mm)

5. Using μ Vision and FlashMagic

In order to be able to modify or write code the following software is required:

- Windows Operating System (Windows 2000, Windows XP or Windows Vista);
- A development tool for ARM7 cores providing source code editing, compiling, linking and debugging. A good (free) option is the evaluation version of the Keil RealView MDK-ARM Microcontroller Development Kit. At the time of writing the first release of this manual, the latest is mdk322a, which is Version 3.22. This can be downloaded at <https://www.keil.com/demo/eval/arm.htm> (registration required). The RealView MDK includes μ Vision (Integrated Development Environment, Debugger and Simulator) and RealView compilation tools for C/C++ and linker. For more information see <http://www.keil.com/arm>;
- Programming utility FlashMagic to flash the .hex file into the LPC2148, see <http://www.flashmagictool.com>. FlashMagic is freeware.

5.1 Keil μ Vision

Evaluation Software from Keil has very few limitations. Each evaluation tool set includes the assembler, compiler, linker, debugger, and IDE. These tools allow to evaluate the quality of the generated code, the speed and flexibility of the debugger, and the ease-of-use provided by the μ Vision IDE.

Keil ARM Evaluation Kits are code size-limited and have the following restrictions:

- The Evaluation Version of the μ Vision IDE/Debugger may not be used to create commercial products;
- Programs that generate more than 16K Bytes of code and data will not compile, assemble, or link;
- The evaluation tools create Symbolic Output Format when the RealView compiler is selected. Fully licensed tools generate standard ELF/DWARF files;
- The debugger supports programs that are 16K Bytes or smaller;

- The RealView Linker does not accept scatter-loading description files for sophisticated memory layouts;
- The RealView Linker restricts the base address for code/constants to 0xXX000000, 0xXX800000, or 0x00080000 where XX is 00, 01, ..., FF. This allows memory start addresses like 0x00000000 and 0x12800000;
- It is not possible to generate position independent code or data;
- The RealView C/C++ Compiler does not generate a listing file;
- The CARM compiler, assembler, and linker (only available in older versions of the Keil MDK) are limited to 16K Bytes of object code. Source code may be of any size;
- The GNU ARM tools (compiler, assembler, and so on) that are provided are not limited or restricted in any way.

In Fig 5 a screenshot of the KEIL IDE is shown while the current firmware was being modified. For a full overview of available support tools (IDE) visit the NXP website.

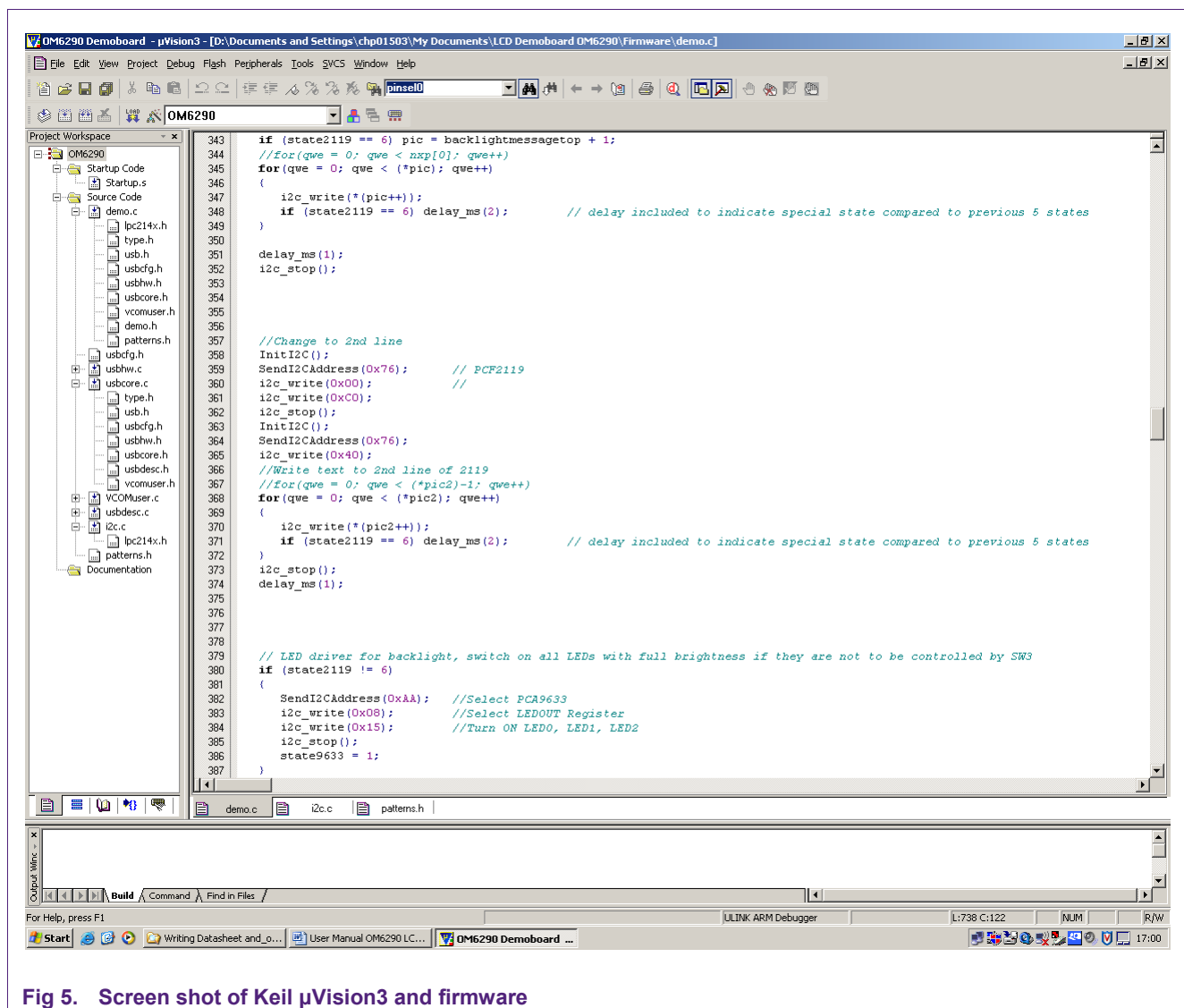

Fig 5. Screen shot of Keil μVision3 and firmware

5.1.1 Installing μ Vision

An evaluation version of μ Vision can be downloaded from the Keil website. Registration is required. The latest version at the time of writing the first version of this manual was 3.22. The file name is mdk322a.exe. File size is close to 100 MB. After download has completed, double click the executable and follow the instructions.

5.1.2 Keil μ Vision Quick Start

The kit firmware includes all the source code for the demo that is programmed into the on board LPC2148 when shipped. The demo project can be modified and downloaded to the board.

Run μ Vision and under the menu item "Project" select "Open Project". Edit the source code and again, under the "Project" menu item, select "Build Target of Build All Targets". To download the code to the board, follow the instruction for Flash Magic in section 5.2.

To create a new project to run on the LCD Eval Board, select The IDE has to be configured for the microcontroller used on the OM6290 board. In order to do so, select "Project" -> "New μ Vision Project" and enter a project name, after which a window similar to that indicated in Fig 6 pops up. Select LPC2148.

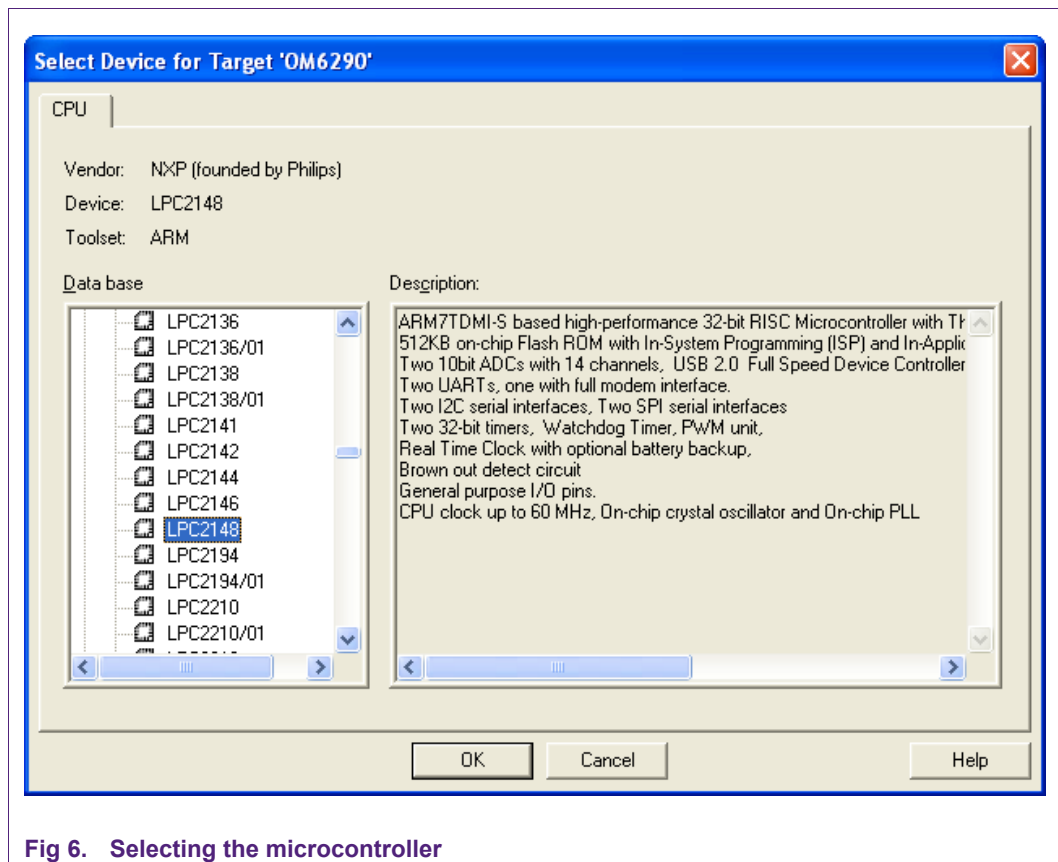

Fig 6. Selecting the microcontroller

As the crystal used on the board is a 12MHz crystal, the setting in the IDE has to correspond with that. In order to achieve this, select Project -> Options for Target 'OM6290'. The window below pops up. Set the Xtal frequency to 12 MHz.

The ARM7 CPU is capable of executing two instruction sets; the ARM instruction set which is 32 bits wide or the Thumb instruction set which is 16 bits wide. This is a compressed form of the ARM instruction set. Although the Thumb instructions will result in lower code performance compared to ARM instructions, they will achieve a much higher code density. High performance (speed) is not needed here and thus Thumb-Mode is used. This can be selected under 'Code Generation', see Fig 7 below. For this, select the tab 'Target'.

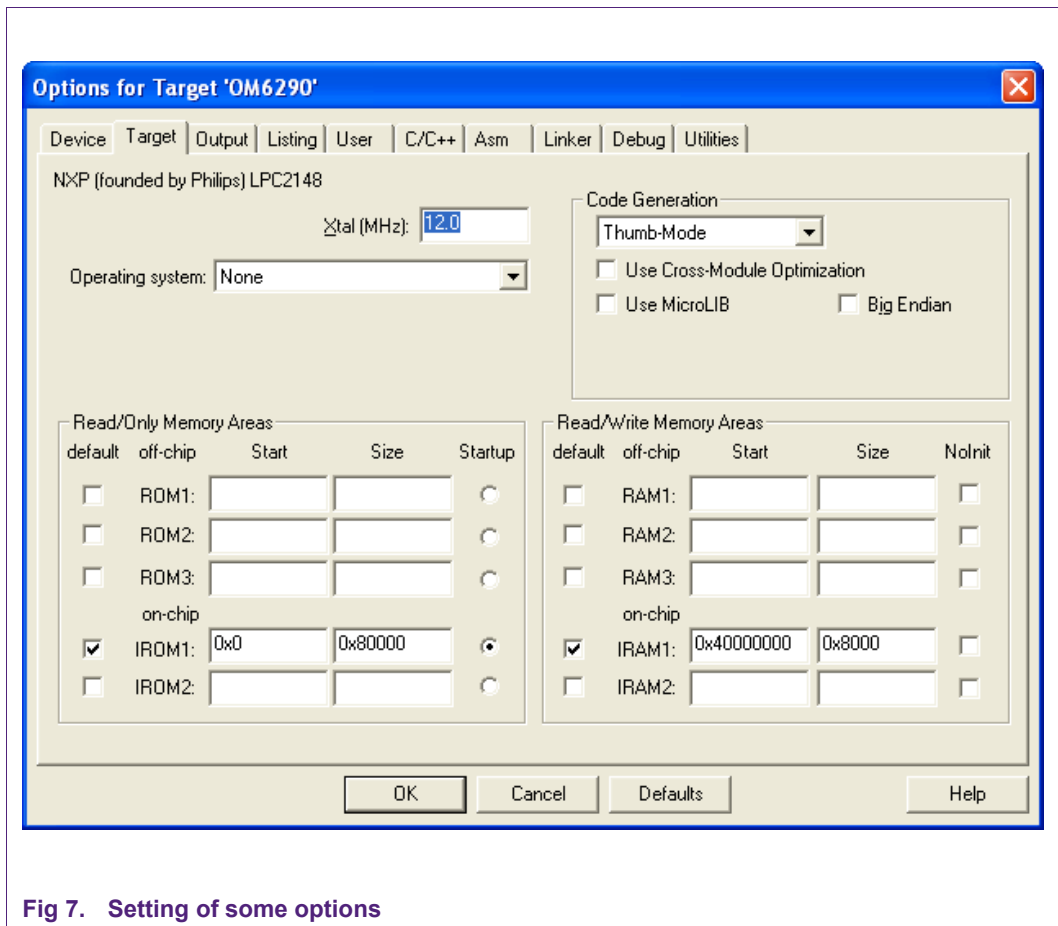

Fig 7. Setting of some options

One restriction of the evaluation version of μ Vision is that the RealView Linker restricts the base address for code/constants to 0xXX000000, 0xXX800000 or 0x00080000 where XX is 00, 01, ..., FF. This allows memory start addresses like 0x00000000 and 0x12800000.

Therefore the R/O Base needs to be set to 0 as indicated in Fig 8 for the code to compile. Select tab 'Linker'. This is valid if the RealView compiler is selected as described below in 5.1.3 "Selection of the toolset".

The meaning of R/O and R/W is as follows:

- R/O: Read Only. This is code and constants.
- R/W: Read and Write. This is data.

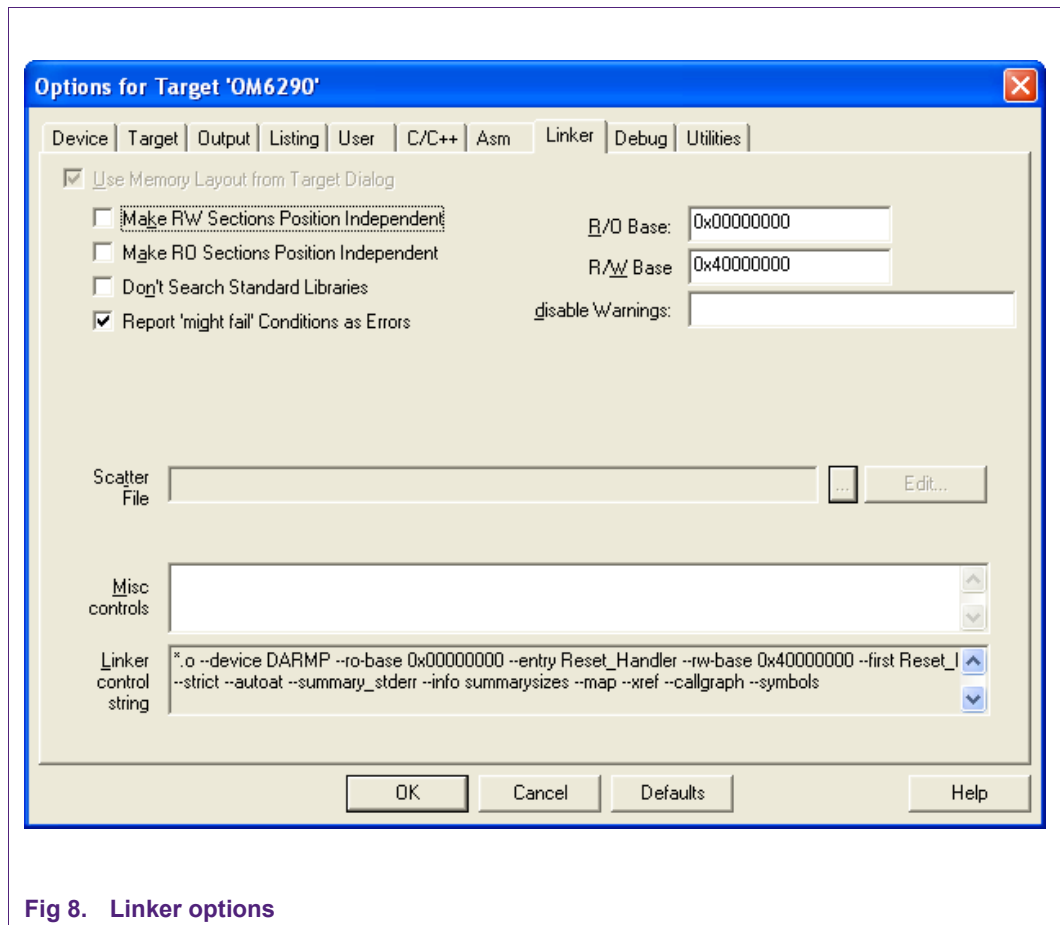

Fig 8. Linker options

5.1.3 Selection of the toolset

The downloaded demoboard firmware contains the file 'OM6290 Demoboard.Uv2' which is the project configuration file. All settings are correct. In case settings are made manually the information provided here is useful.

µVision uses either the ARM RealView compilation tools, the ARM ADS compiler, the GNU GCC compiler or the Keil CARM compiler. Older versions of the Keil uVision IDE came with the CARM compiler and the GNU GCC compiler. After Keil became an ARM company, the CARM compiler was replaced by RealView and current downloads don't include the CARM compiler anymore. It is recommended to use the RealView compiler since this is also the tool used by NXP for the development of the code for this board. In this case downloaded software will be compatible with the tool and time consuming fixes and adaptations are avoided.

The toolset to be used can be selected in the μ Vision IDE under Project -> Manage -> Components, Environment, Books. This is indicated in Fig 9.

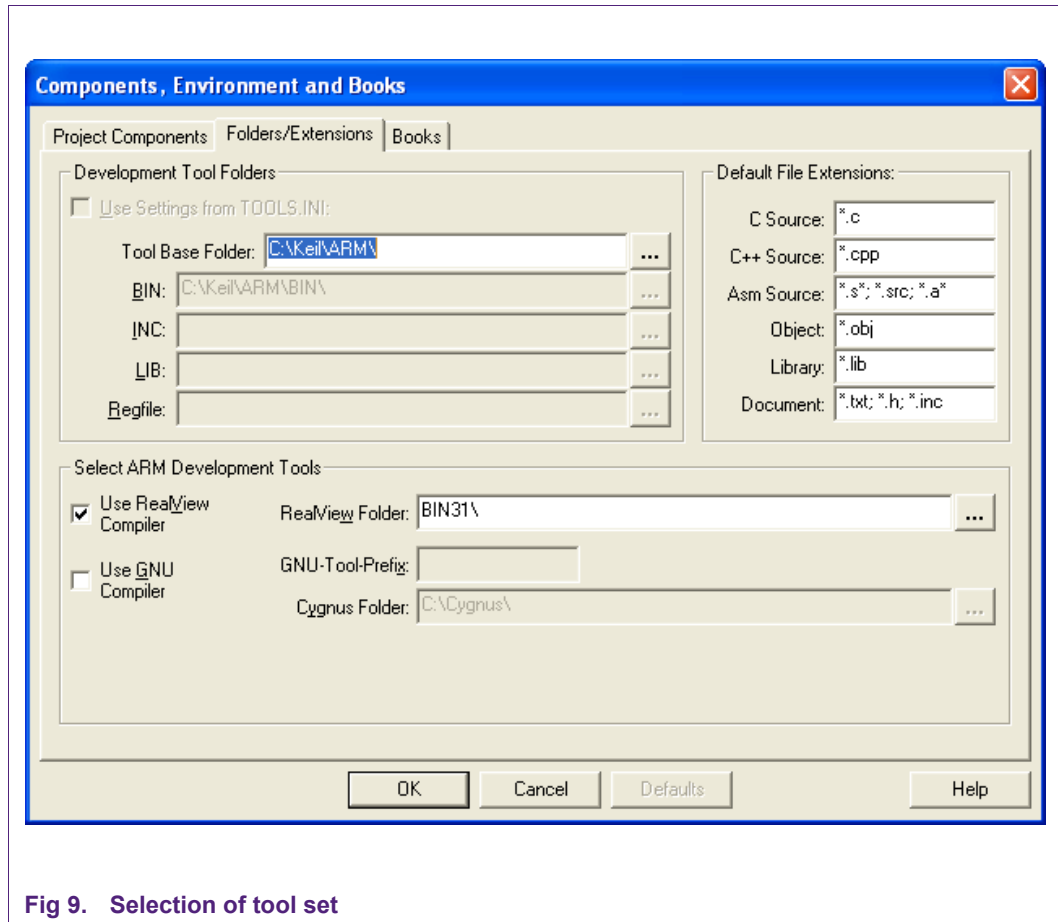

Fig 9. Selection of tool set

5.2 The FlashMagic Utility

NXP has partnered with Embedded Systems Academy to provide a free tool for flash programming called FlashMagic. It uses a serial protocol and allows programming while the controller is in the target hardware and supports the entire LPC2000 family (except LPC288x).

Most important features:

- Straightforward and intuitive user interface;
- Five simple steps to erasing and programming a device and setting any options desired;
- Programs Intel Hex Files;
- Automatic verifying after programming;
- Fills unused Flash to increase firmware security;
- Ability to automatically program checksums. Using the supplied checksum calculation routine the firmware can easily verify the integrity of a Flash block, ensuring no unauthorized or corrupted code can ever be executed;

- Program security bits;
- Check which Flash blocks are blank or in use with the ability to easily erase all blocks in use;
- Read the device signature;
- Read any section of Flash and save as an Intel Hex File;
- Reprogram the Boot Vector and Status Byte with the help of confirmation features that prevent accidentally programming incorrect values;
- Display the contents of Flash in ASCII and Hexadecimal formats;
- Single-click access to the manual, Flash Magic home page and NXP Microcontrollers home page;
- Ability to use high-speed serial communications on devices that support it. Flash Magic calculates the highest baudrate that both the device and the PC can use and switches to that baudrate transparently;
- Command Line interface allowing Flash Magic to be used in IDEs and Batch Files;
- Manual in PDF format;
- Supports half-duplex communications;
- Verify Hex Files previously programmed;
- Save and open settings;
- Able to reset Rx2 and 66x devices (revision G or higher);
- Able to control the DTR and RTS RS232 signals when connected to RST and /PSEN to place the device into BootROM and Execute modes automatically. An example circuit diagram is included in the Manual. Essential for ISP with target hardware that is hard to access;
- Able to send commands to place the device in BootROM mode, with support for command line interfaces. The installation includes an example project for the Keil and Raisonance 8051 compilers that show how to build support for this feature into applications;
- Able to play any Wave file when finished programming;
- Built in automated version checker - helps ensure that always the latest version is used;
- Powerful, flexible Just In Time Code feature. Write your own JIT Modules to generate last minute code for programming. Uses include:
 - Serial number generation
 - Copy protection and copy authorization
 - Storing program date and time - manufacture date
 - Storing program operator and location
 - Lookup table generation
 - Language tables or language selection
 - Centralized record keeping
- Displays information about the selected Hex File, including the creation and modification dates, flash memory used, percentage of the current device used
- For more information visit www.flashmagictool.com

In Fig 10 a screenshot of Flash Magic (with correct settings, version 3.59) is given.

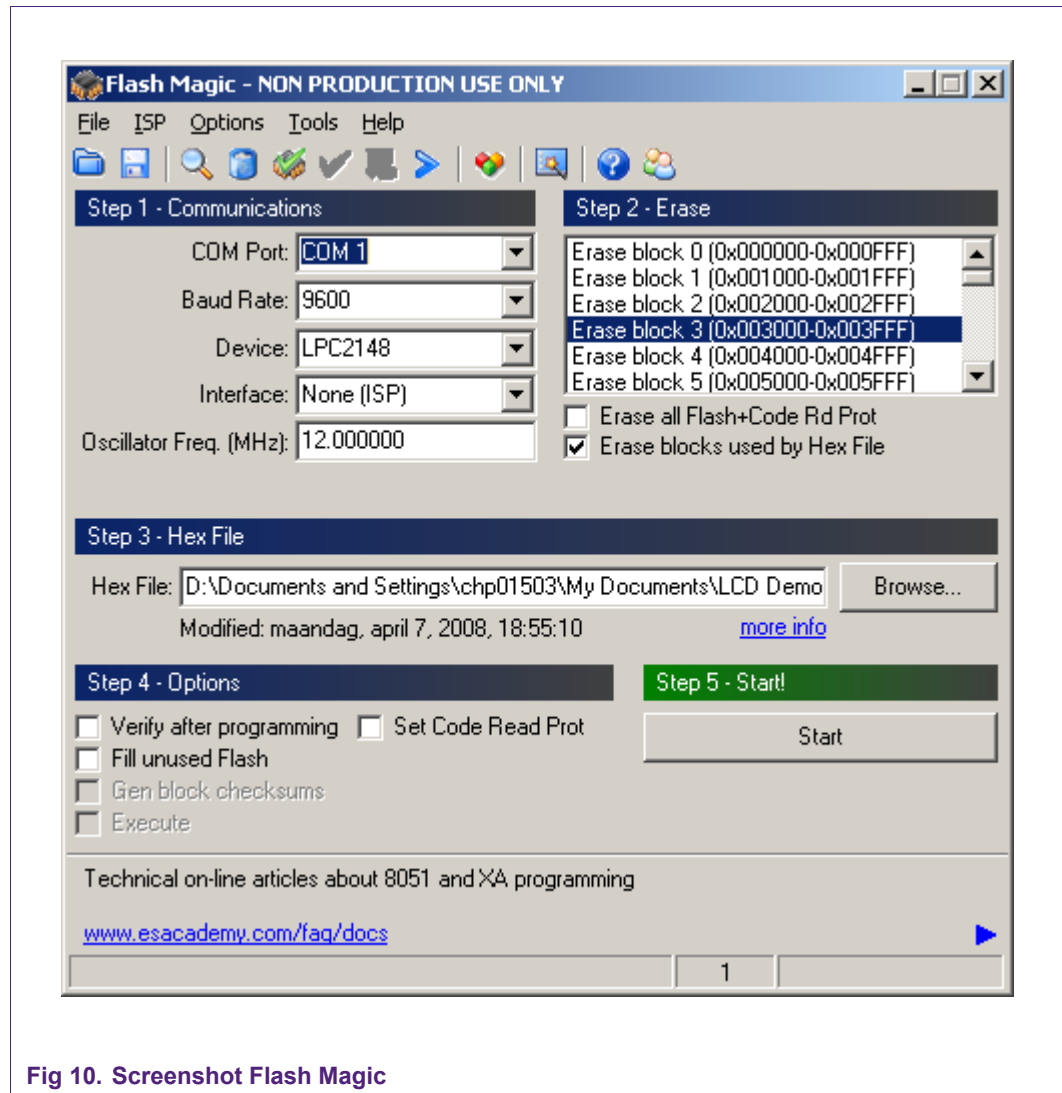

Fig 10. Screenshot Flash Magic

Remark:

Some boards were programmed with code compiled using CARM compiler. If the code compiles using RealView but does not run after programming the LPC2148, checking the option 'Erase all Flash+Code Rd Prot' may help. RealView generates smaller files and checking this option will clear all flash. For subsequent modifications, this option can then be unchecked again.

6. Flash Magic Quick Start

Setting up the OM6290 board is easy and explanations for the board setup are given here.

In stand-alone mode only a 9V battery is used to provide power to the board and let the onboard program run. The board is protected against reversed polarisation of the supply voltage. Alternatively the USB port can be used to provide power. If also firmware needs to be modified, the OM6290 board requires a serial connection for In-System Programming and with a PC already present it is then more economical to use a USB connection for power. Especially with the backlight fully lit battery lifetime is reduced which is not an issue if power is supplied via USB. Refer to Chapter 9 for technical data.

When the board is first plugged into the USB port of the PC, Windows will ask for a driver for 'Philips LPC2148 VCOM'. The host driver that came with the sample software is under the "PLPU-S2K" directory.

6.1 Connecting with serial ISP

To connect the OM6290 board for serial programming:

- Set switch S1 to position 'Program Flash';
- Ensure a jumper is on J3 (can move jumper from J5 for programming);
- Provide power to the board using a standard USB cable. Battery supply will work too, but since a PC is being used anyway it is recommended to use the option of USB powering the board;
- Connect a user supplied 9-pin serial cable from a COM port on the PC to RS1 on the OM6290 board;
- Verify the COM connection using FlashMagic. To do this:
 - a. Start Flash Magic (using Start – Programs – Flash Magic – Flash Magic) and configure the COM port interface as indicated below.

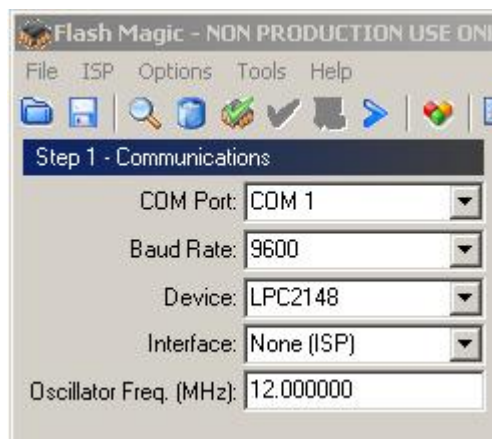

Fig 11. Settings for connecting with serial ISP

- b. Verify the COM connection using the menu command ISP – Read Device Signature
- c. The Read Device Signature window pops up as below

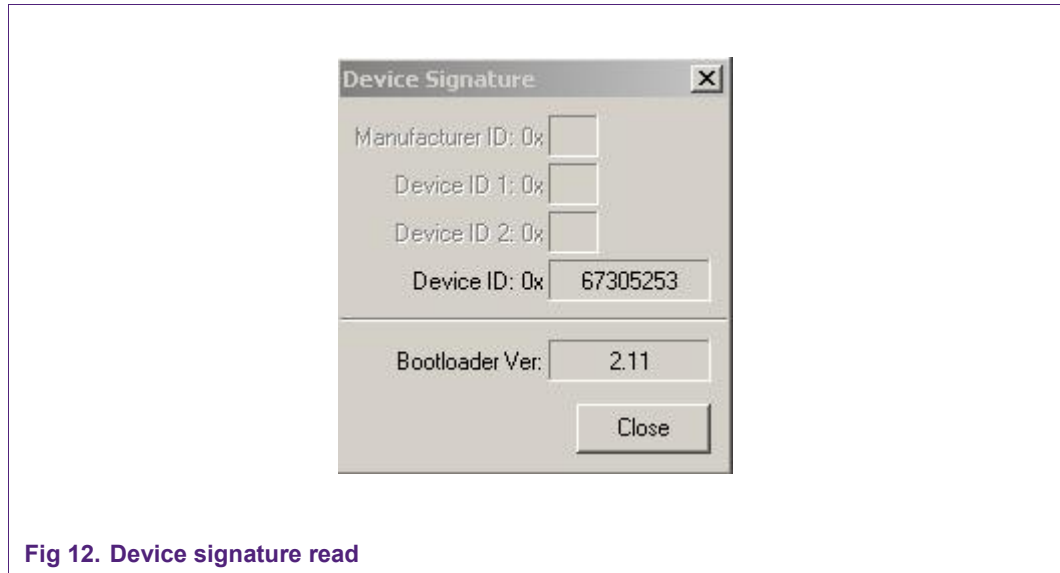

Fig 12. Device signature read

Click on Close to close the window. If this all works, the COM port communicates with the onboard controller. If reading the device signature does not function, select Options – Advanced Options on the menubar of the FlashMagic program. Then select the tab “Hardware Config” and uncheck the option “Use DTR and RTS to control RST and P0.14”. Alternatively, place jumper J3.

7. Software Description

To facilitate the understanding of the sample software, please review the training module available soon on the website:

<http://www.standardics.nxp.com/support/boards/om6290/>

8. Schematic

The schematic and board layout are in a separate file on the CD or website:

<http://www.standardics.nxp.com/support/boards/om6290/>

9. Technical Data

Table 1. Technical Data

Short summary of Technical Data, indicative values only

Parameter	Value	Remark
Supply Voltage	+5V via USB +9V via battery	Supply current via USB is about 5 mA less than via battery supply.
Battery Supply Current Backlight Off	100 mA typ.	
Battery Supply Current Backlight On	210 mA max.	Depends on chosen settings for LED currents in registers of PCA9633, thus can be higher.
XTAL frequency	12 MHz	Allows up to 60 MHz CPU clock.
Key Components	PCF8576DT/2 PCF2119SU/2 PCF8531U/2 LPC2148FBD64	Segment Driver Character Driver, Chip On Glass Graphic Driver, Chip On Glass Microcontroller
Peripheral connections	1 x USB Interface 1 x RS-232 Interface 1 x JTAG Interface I ² C bus Unused μ C pins	After mounting P4 After mounting P1, P2
Board dimensions	125 mm x 140 mm	

10. Software versions

Below the software versions are listed with a short description of changes with respect to previous versions.

Table 2. Software versions

Software Version	Release Date	Remarks
1.0	01-02-2008	First version. Compiled with CARM tools.
1.1	06-06-2008	Changed startup screen of LCD1. Includes version number. Included 'display shift' on LCD2. Compiled with CARM tools.
1.2	18-06-2008	Same functionality as v1.1. Modified in order to be compatible with RealView compiler. First version to be posted on the internet for download.

11. Parts List

Below the parts list of the board is given.

Table 3. Component list (BOM)

Bill of Material

Main category	Designator	Type / value	Description	Footprint
Passives	R17, R27	33 Ω	resistor	0805
	R25, R26	68 Ω	resistor	0805
	R24	82 Ω	resistor	0805
	R12	330 Ω	resistor	0805
	R18, R29	470 Ω	resistor	0805
	R14, R15, R16	1 k Ω	resistor	0805
	R10	1k5	resistor	0805
	R11	2k2	resistor	0805
	R28	4k7	resistor	0805
	R22, R23	6k8	resistor	0805
	R7, R9, R19, R20, R21, R30, R31, R32, R33, R34, R35, R36, R37, R38, R39, R40	10 k	resistor	0805
	R1, R3, R6	22 k	resistor	0805
	R2, R4, R13	33 k	resistor	0805
	R8	100 k	resistor	0805
	Capacitors	C10, C11	18 pF	capacitor
C12, C13		22 pF	capacitor	0805
C27		47 nF	capacitor	0805
C1, C2, C3, C4, C5, C6, C7, C8, C9, C14, C15, C19, C22, C23, C24, C25, C26, C28		100 nF	capacitor	0805
C20, C21		470 nF	capacitor	0805
C16, C17		10 μ F	polarized capacitor	C0805
C18		47 μ F	Polarized capacitor	C0805

Main category	Designator	Type / value	Description	Footprint
	Y1	Rakon LF A158K	Crystal 12 MHz	
Semiconductors	IC1	MAX3232ECAE+	RS-232 transceiver	SSOP16
	IC2	LPC2148FBD64	Micro controller	LQFP64 / SOT314-2
	IC3	PCF8576DT/2	Segment driver	TSSOP56 / SOT364-1
	IC4	PRTR5V0U2AX	ESD protection	SOT143
	IC5	PCA9633	LED driver	SSOP16
	IC6	MAX811T	Reset circuit	SOT143
	VR1	LM1117MP-5.0	Voltage regulator	SOT223
	VR2	LM1117MP-3.3	Voltage regulator	SOT223
	D1,D2,D3,D5,D6	BAS16	Small signal diode	SOT23
	D4	HSMD-A100-L00J1	LED orange	PLCC-2
	D7	HSMG-A100-K42J2	LED green	PLCC-2
	T1,T2,T4,T5,T6	BC847	Transistor	SOT23
	T3	BC857	Transistor	SOT23
Displays	LCD1	TIC48, Gamma	Dot matrix display	
	LCD2	VL-FS-COG-12264N-01, Varitronix	Character display	
	LCD3	ERS5161-1, Admatec	Segment display	
	BL1	MZP289A-01	Back light for LCD3	
Mechanical	USB1		USB connector B	
	RS1		D connector 9, female	
	J1, J2, J3, J5		Jumper 2-pin	
	J4		Jumper 3-pin	
	P3		Pin strip 9 pins	
	Batt		Battery holder for 9V	
	S1, S2		Slider switch	
	SW1, SW2, SW3, SW4		Push button switch	

12. References

The documents listed below provide further useful information. They are available on the CD but the latest versions can be downloaded from NXP's website www.nxp.com or on www.standardics.nxp.com.

1. Product data sheet PCF8576D;
2. Product data sheet PCF2119;
3. Product data sheet PCF8531;
4. Product data sheet LPC2148;
5. UM10139; LPC214x User Manual;
6. UM10204; I²C-bus specification and user manual. Rev 3, 19 June 2007.
7. Keil website, for μ Vision IDE: www.keil.com
8. Flash Magic Tool: www.flashmagictool.com

13. Legal information

13.1 Definitions

Draft — The document is a draft version only. The content is still under internal review and subject to formal approval, which may result in modifications or additions. NXP Semiconductors does not give any representations or warranties as to the accuracy or completeness of information included herein and shall have no liability for the consequences of use of such information.

13.2 Disclaimers

General — Information in this document is believed to be accurate and reliable. However, NXP Semiconductors does not give any representations or warranties, expressed or implied, as to the accuracy or completeness of such information and shall have no liability for the consequences of use of such information.

Right to make changes — NXP Semiconductors reserves the right to make changes to information published in this document, including without limitation specifications and product descriptions, at any time and without notice. This document supersedes and replaces all information supplied prior to the publication hereof.

Suitability for use — NXP Semiconductors products are not designed, authorized or warranted to be suitable for use in medical, military, aircraft, space or life support equipment, nor in applications where failure or malfunction of a NXP Semiconductors product can reasonably be expected to result in personal injury, death or severe property or environmental damage. NXP Semiconductors accepts no liability for inclusion and/or use of NXP Semiconductors products in such equipment or applications and therefore such inclusion and/or use is for the customer's own risk.

Applications — Applications that are described herein for any of these products are for illustrative purposes only. NXP Semiconductors makes no representation or warranty that such applications will be suitable for the specified use without further testing or modification.

13.3 Trademarks

Notice: All referenced brands, product names, service names and trademarks are property of their respective owners.

<Name> — is a trademark of NXP B.V.

14. Contents

1.	Introduction	3	4.	The onboard microcontroller.....	14
2.	Board description and layout.....	4	5.	Using μVision and FlashMagic.....	15
2.1	Switches.....	5	5.1	Keil μ Vision	15
2.2	LED indicators.....	5	5.1.1	Installing μ Vision	17
2.3	Jumpers	5	5.1.2	Selection of the microcontroller	17
2.4	Connectors.....	6	5.1.3	Selection of the toolset	19
2.5	Reserved components	6	5.2	The FlashMagic Utility	20
2.6	Hardware requirements.....	7	6.	Quick Start	23
2.7	Software requirements	7	6.1	Connecting with serial ISP.....	23
2.8	Modes of operation	7	7.	Software Description.....	24
3.	The LCD Drivers	8	8.	Schematic.....	24
3.1	Segment Driver PCF8576D.....	9	9.	Technical Data	25
3.1.1	General Description	9	10.	Software versions.....	25
3.1.2	Features	9	11.	Partslist	26
3.1.3	Block diagram	10	12.	References	28
3.2	Character Driver PCF2119.....	10	13.	Legal information	29
3.2.1	General Description	10	13.1	Definitions.....	29
3.2.2	Features	11	13.2	Disclaimers.....	29
3.2.3	Block diagram	12	13.3	Trademarks	29
3.3	Graphic Driver PCF8531	12	14.	Contents	30
3.3.1	General Description	12			
3.3.2	Features	13			
3.3.3	Block diagram	14			

Please be aware that important notices concerning this document and the product(s) described herein, have been included in the section 'Legal information'.

© NXP B.V. 2008. All rights reserved.

For more information, please visit: <http://www.nxp.com>

For sales office addresses, email to: salesaddresses@nxp.com

Date of release: 8 August 2008

Document identifier: UM10300_1



Mouser Electronics

Authorized Distributor

Click to View Pricing, Inventory, Delivery & Lifecycle Information:

[NXP:](#)

[OM6290](#)