



FRENIC-MEGA



DeviceNet 通信カード
DeviceNet Communications Card
"OPC-G1-DEV"

日本語

ENGLISH

English Version

ENGLISH

Preface

Thank you for purchasing our DeviceNet Communications Card OPC-G1-DEV.

Mounting this communications card on your FRENIC-MEGA allows you to connect the FRENIC-MEGA to a DeviceNet master unit (e.g., PC and PLC) and control it as a slave unit using the run command, speed command, and access to function codes.

This communications card has the following features:

- ~ Data Rate (baud rate): 125 kbps, 250 kbps, 500 kbps
- ~ I/O Message: Polling and Change of State supported
- ~ Applicable Profile: AC Drive profile
- ~ Reading and writing all the function codes applicable to the FRENIC-MEGA (I/O Message (User Defined Assembly Instance or Access to Function Codes Instance) and Explicit Message)

This product has been tested by ODVA authorized Independent Test Lab and found to comply with ODVA's DeviceNet Conformance Test Version 20.



DeviceNet™ is a trademark of Open DeviceNet Vendor Association, Inc. (ODVA).

This instruction manual does not contain inverter handling instructions. Read through this instruction manual in conjunction with the FRENIC-MEGA Instruction Manual and be familiar with proper handling and operation of this product. Improper handling might result in incorrect operation, a short life, or even a failure of this product.

Keep this manual in a safe place.

Related Publications

Listed below are the other materials related to the use of the DeviceNet communications card "OPC-G1-DEV." Read them in conjunction with this manual as necessary.

- ~ RS-485 Communication User's Manual)
- ~ FRENIC-MEGA Instruction Manual

The materials are subject to change without notice. Be sure to obtain the latest editions for use.



CAUTION

- ~ Read through this instruction manual and be familiar with the DeviceNet communications card before proceeding with installation, connections (wiring), operation, or maintenance and inspection.
- ~ Improper handling might result in incorrect operation, a short life, or even a failure of this product as well as the motor.
- ~ Deliver this manual to the end user of this product. Keep this manual in a safe place until this product is discarded.

■ Safety precautions

Read this manual thoroughly before proceeding with installation, connections (wiring), operation, or maintenance and inspection. Ensure you have sound knowledge of the device and familiarize yourself with all safety information and precautions before proceeding to operate the inverter.

Safety precautions are classified into the following two categories in this manual.

 WARNING	Failure to heed the information indicated by this symbol may lead to dangerous conditions, possibly resulting in death or serious bodily injuries.
 CAUTION	Failure to heed the information indicated by this symbol may lead to dangerous conditions, possibly resulting in minor or light bodily injuries and/or substantial property damage.

Failure to heed the information contained under the CAUTION title can also result in serious consequences. These safety precautions are of utmost importance and must be observed at all times.

Installation and wiring

WARNING

- “ Before starting installation and wiring, turn OFF the power and wait at least five minutes for inverters with a capacity of 22 kW or below, or at least ten minutes for inverters with a capacity of 30 kW or above. Make sure that the LED monitor and charging lamp are turned OFF. Further, make sure, using a multimeter or a similar instrument, that the DC link bus voltage between the terminals P(+) and N(-) has dropped to the safe level (+25 VDC or below).
Otherwise, an electric shock could occur.
- “ Qualified electricians should carry out wiring.
Otherwise, an electric shock could occur.

CAUTION

- “ Do not use the product that is damaged or lacking parts.
Doing so could cause a fire, an accident, or injuries.
- “ Prevent lint, paper fibers, sawdust, dust, metallic chips, or other foreign materials from getting into the inverter and the communications card.
Otherwise, a fire or an accident might result.
- “ Incorrect handling in installation/removal jobs could cause a failure.
A failure might result.
- “ Noise may be emitted from the inverter, motor and wires. Implement appropriate measure to prevent the nearby sensors and devices from malfunctioning due to such noise.
Otherwise, an accident could occur.

Operation

WARNING

- “ Be sure to install the front cover before turning the inverter's power ON. Do not remove the cover when the inverter power is ON.
Otherwise, an electric shock could occur.
- “ Do not operate switches with wet hands.
Doing so could cause an electric shock.
- “ If you configure the function codes wrongly or without completely understanding FRENIC-MEGA Instruction Manual and the FRENIC-MEGA User's Manual, the motor may rotate with a torque or at a speed not permitted for the machine. Confirm and adjust the setting of the function codes before running the inverter.
Otherwise, an accident could occur.

Maintenance and inspection, and parts replacement

WARNING

- “ Before proceeding to the maintenance/inspection jobs, turn OFF the power and wait at least five minutes for inverters with a capacity of 22 kW or below, or at least ten minutes for inverters with a capacity of 30 kW or above. Make sure that the LED monitor and charging lamp are turned OFF. Further, make sure, using a multimeter or a similar instrument, that the DC link bus voltage between the terminals P(+) and N(-) has dropped to the safe level (+25 VDC or below).
Otherwise, an electric shock could occur.
- “ Maintenance, inspection, and parts replacement should be made only by qualified persons.
- “ Take off the watch, rings and other metallic objects before starting work.
- “ Use insulated tools.
Otherwise, an electric shock or injuries could occur.

Disposal

CAUTION

- “ Treat the communications card as an industrial waste when disposing of it.
Otherwise injuries could occur.

Others

WARNING

- “ Never modify the communications card.
Doing so could cause an electric shock or injuries.

Icons

The following icons are used throughout this manual.



This icon indicates information which, if not heeded, can result in the product not operating to full efficiency, as well as information concerning incorrect operations and settings which can result in accidents.



This icon indicates information that can prove handy when performing certain settings or operations.



This icon indicates a reference to more detailed information.

Table of Contents

Preface	1	7.3 An Example of Actual I/O Communication Data	24
■ Safety precautions.....	1	7.3.1 Extended Speed Control Instance.....	24
Chapter 1 BEFORE USING THE COMMUNICATIONS CARD.....	5	7.4 I/O Assembly Instances Assigned to Word Variables (For reference).....	26
1.1 Acceptance Inspection	5	7.4.1 Basic Speed Control Instance	26
1.2 Applicable Inverters.....	5	7.4.2 Extended Speed Control Instance.....	26
Chapter 2 BASIC FUNCTIONS AND SETTINGS.....	6	7.4.3 Fuji Drive Assembly Instance	26
2.1 Parts Names.....	6	7.4.4 User Defined Assembly Instance	27
2.2 DIP Switch	6	7.4.5 Access to Function Codes	27
2.3 LED Status Indicators	7	Chapter 8 EXPLICIT MESSAGE	28
2.4 DeviceNet Terminal Block.....	7	8.1 Overview.....	28
Chapter 3 INSTALLATION AND REMOVAL OF THE COMMUNICATIONS CARD	8	8.2 Objects to be Used in Explicit Message.....	28
3.1 Installing the Communications Card.....	8	8.3 Error Code List for Explicit Message Errors.....	33
3.2 Removing the Communications Card.....	10	Chapter 9 INVERTER REACTION TO DeviceNet COMMUNICATIONS ERRORS	34
Chapter 4 WIRING AND CABLING	11	Chapter 10 ALARM CODE LIST.....	35
4.1 Basic Connection Diagram	11	Chapter 11 TROUBLESHOOTING.....	36
4.2 Wiring for DeviceNet Terminal Block	12	Chapter 12 SPECIFICATIONS	37
4.3 Wiring to Inverter	12	12.1 General Specifications	37
Chapter 5 CONFIGURING INVERTER'S FUNCTION CODES FOR DeviceNet COMMUNICATION .	14	12.2 DeviceNet Specifications	37
Chapter 6 ESTABLISHING A DeviceNet COMMUNICATIONS LINK	15		
Chapter 7 I/O MESSAGE	16		
7.1 Overview	16		
7.2 I/O Assembly Instances: Selection and Setup	17		
7.2.1 Basic Speed Control Instance	17		
7.2.2 Extended Speed Control Instance (factory default).....	18		
7.2.3 Fuji Drive Assembly Instance	19		
7.2.4 User Defined Assembly Instance	20		
7.2.5 Access to Function Codes	22		

Chapter 1 BEFORE USING THE COMMUNICATIONS CARD

1.1 Acceptance Inspection

Unpack the package and check the following:

- (1) A communications card, two screws (M3 × 8), and the DeviceNet Communications Card Instruction Manual (this manual) are contained in the package.
- (2) The communications card is not damaged during transportation--no defective parts, dents or warps.
- (3) The model name "OPC-G1-DEV" is printed on the communications card. (See Figure 2.1.)

If you suspect the product is not working properly or if you have any questions about your product, contact the shop where you bought the product or your local Fuji branch office.



Neither an EDS file nor a terminating resistor comes with the communications card.

- An EDS file is required for registering the communications card to the configurator designed for DeviceNet master node settings. It is available as a free download from our website at:

<http://web1.fujielectric.co.jp/Kiki-Info-EN/User/index.html>

Before downloading, you are requested to register as a member (free of charge).

- A terminating resistor of the following specifications must be used: 121 ohm ±1%, 1/4 watt, metal-film resistor

1.2 Applicable Inverters

The DeviceNet communications card is applicable to the following inverters and ROM version.

Table 1.1 Applicable Inverter and ROM Version

Series	Inverter type	Applicable motor rating	ROM version
FRENIC-MEGA	FRN□□□G1□-□□□	All capacities	0500 or later

* The boxes □ replace alphanumeric letters depending on the nominal applied motor, enclosure, power supply voltage, etc.

To check the inverter's ROM version, use Menu #5 "Maintenance Information" on the keypad. (Refer to the FRENIC-MEGA Instruction Manual, Chapter 3, Section 3.4.6 "Reading maintenance information.")

Table 1.2 Checking Inverter ROM Version

Display on LED Monitor	Item	Description
5_ 14	Inverter's ROM version	Shows the inverter's ROM version as a 4-digit code.

Chapter 2 BASIC FUNCTIONS AND SETTINGS

2.1 Parts Names

Figure 2.1 shows the names of the parts on the DeviceNet communications card.

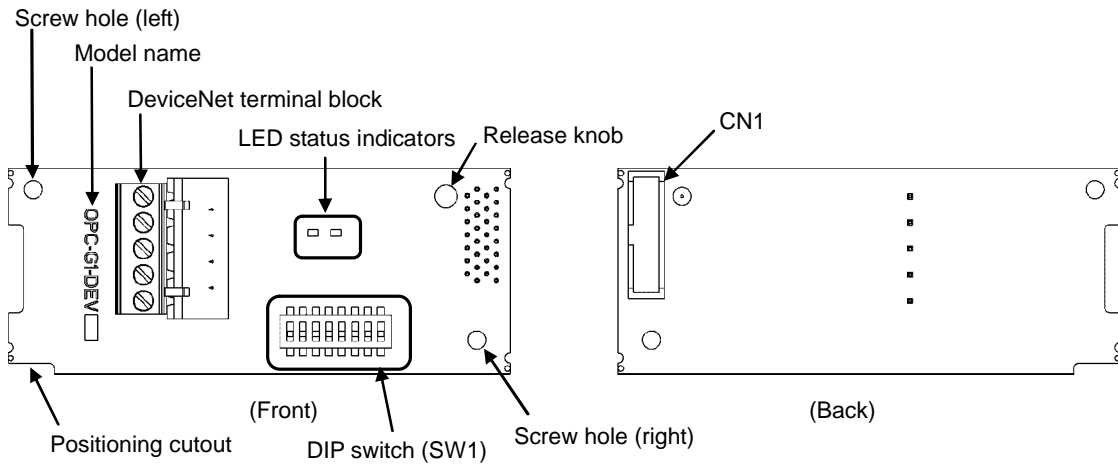

Figure 2.1 Names of Parts on DeviceNet Communications Card (OPC-G1-DEV)

2.2 DIP Switch

The DIP switch specifies the communication data rate (baud rate) and the node address (MAC ID) on DeviceNet. It offers a choice of three baud rates (125 kbps, 250 kbps, and 500 kbps) and a choice of node address (MAC ID) ranging from 0 to 63.

Note Before accessing the DIP switch, make sure that the inverter is turned OFF.

The default configuration of the DIP switch at factory shipment is: Data rate = 500 kbps, Node address = 63.

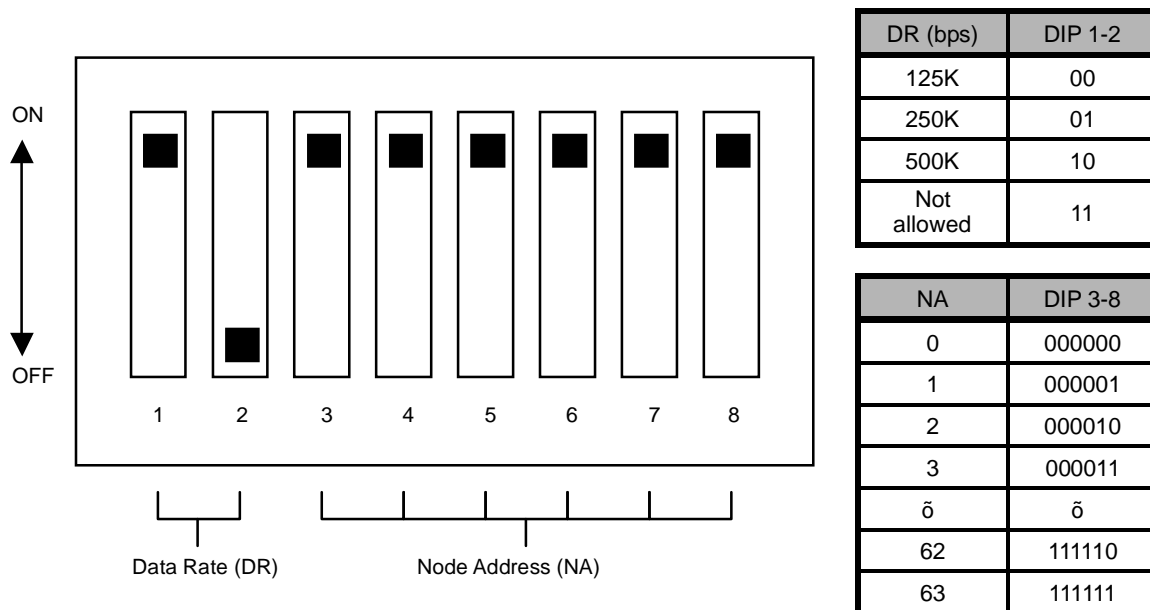

Figure 2.2 DIP Switch Configuration (showing an example of Data rate = 500 kbps and Node address = 63)

2.3 LED Status Indicators

The communications card has two LED status indicators shown below. They indicate the status of the communications card.



- MS (Module Status)
Indicates the hardware status of the DeviceNet communications card.
- NS (Network Status)
Indicates the communication status on DeviceNet.

The tables below show the states of the LEDs and their meanings.

Table 2.1 MS LED state

MS LED	Status	Meaning	Note
Blinks between green and red*1	Self-diagnostic test	Running self-diagnostic test upon power-on	This test takes 1 second.
OFF	Power OFF	Powered OFF	The inverter issues E_r-4
Lights in green	Hardware normal	Hardware working normally	.
Lights in red	Hardware error	Communications card not properly mounted or hardware failure	The inverter issues E_r-4

Table 2.2 NS LED state

NS LED	Status	Meaning	Note
Blinks between green and red*1	Self-diagnostic test	Running self-diagnostic test upon power-on	This test takes 1 second.
OFF	Offline	DeviceNet being offline	.
Blinks in green	Online	DeviceNet cabling correct and communications card not communicating on the DeviceNet network	Waiting for a request from the master
Lights in green	Connection established	Communications card communicating normally on the DeviceNet network	.
Blinks in red	Connection timeout	Connection timeout between the communications card and the master - Too short communication cycle time	The inverter issues E_r-5 *2
Lights in red	Connection error	Improper DeviceNet cabling, or improper settings - Node address double assigned - Data rate mismatch - Bus-off state detected - Power supply cable for the DeviceNet unconnected - Improper wiring for the DeviceNet terminal block	The inverter issues E_r-5 *2

*1 Blinks in the pattern specified in the DeviceNet specifications.

*2 E_r-5 cannot be reset until the NS LED comes to stay on in green. A setting for ignoring E_r-5 is also available even if a connection error is detected. For details, refer to Chapter 9 "INVERTER REACTION TO DeviceNet COMMUNICATIONS ERRORS."

2.4 DeviceNet Terminal Block

The DeviceNet terminal block is used to connect the DeviceNet cable.

 For details, refer to Chapter 4 "WIRING AND CABLING."

Chapter 3 INSTALLATION AND REMOVAL OF THE COMMUNICATIONS CARD

WARNING

Before starting installation and wiring, turn OFF the power and wait at least five minutes for inverters with a capacity of 22 kW or below, or at least ten minutes for inverters with a capacity of 30 kW or above. Make sure that the LED monitor and charging lamp are turned OFF. Further, make sure, using a multimeter or a similar instrument, that the DC link bus voltage between the terminals P(+) and N(-) has dropped to the safe level (+25 VDC or below).

Otherwise, an electric shock could occur.

CAUTION

- “ Do not use the product that is damaged or lacking parts.
Doing so could cause a fire, an accident, or injuries.
- “ Prevent lint, paper fibers, sawdust, dust, metallic chips, or other foreign materials from getting into the inverter and the communications card.
Otherwise, a fire or an accident might result.
- “ Incorrect handling in installation/removal jobs could cause a failure.
A failure might result.

3.1 Installing the Communications Card



Note Before mounting the communications card, perform the wiring for the main circuit terminals and control circuit terminals.

- (1) Remove the front cover from the inverter and expose the control printed circuit board (control PCB). As shown in Figure 3.1, the communications card can be connected to any one of the three option connection ports (A-, B-, and C-ports) on the inverter.



To remove the front cover, refer to the FRENIC-MEGA Instruction Manual, Chapter 2, Section 2.3. For inverters with a capacity of 30 kW or above, open also the keypad enclosure.

- (2) Insert connector CN1 on the back of the communications card (Figure 2.1) into any of the A-port (CN4), B-port (CN5), and C-port (CN6) on the inverter's control PCB. Then tighten the two screws that come with the card. (Figure 3.3)



Note Check that the positioning cutout (shown in Figure 2.1) is fitted on the tab (① in Figure 3.2) and connector CN1 is fully inserted (② in Figure 3.2). Figure 3.3 shows the communications card correctly mounted.

- (3) Perform wiring on the communications card.



For details, refer to Chapter 4 "WIRING AND CABLING."

- (4) Put the front cover back into place.



To put back the front cover, refer to the FRENIC-MEGA Instruction Manual, Chapter 2, Section 2.3. For inverters with a capacity of 30 kW or above, close also the keypad enclosure.

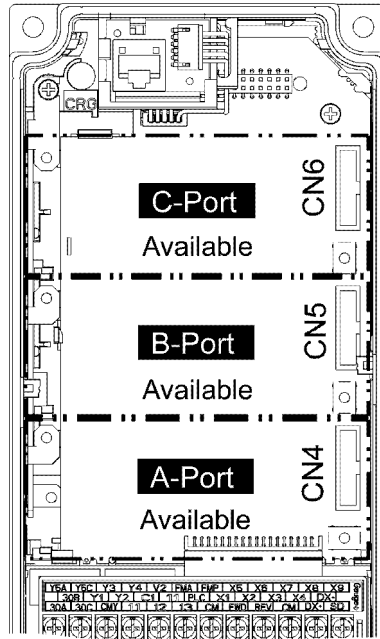

Figure 3.1 In the case of 0.4 kW

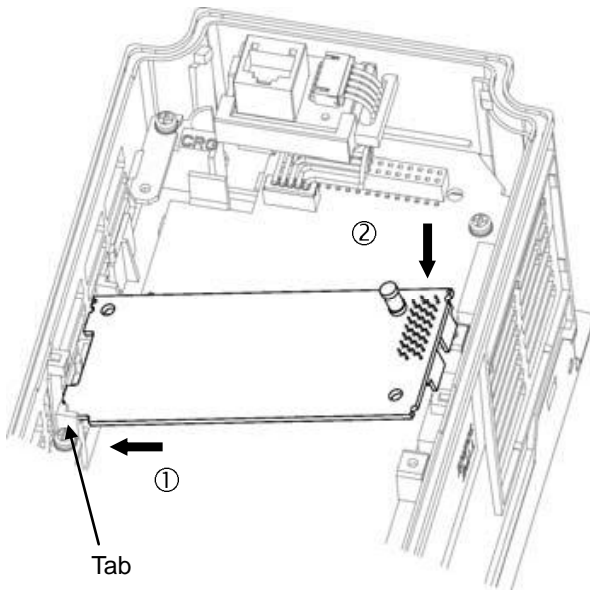

Figure 3.2 Mounting the Communications Card (to B-port)

- ① Fit the positioning cutout of the communications card over the tab on the inverter to determine the mounting position.
- ② Insert connector CN1 on the communications card into the corresponding port on the inverter's control PCB.

Note: Be sure to follow the order of ① and ②. Inserting CN1 first may lead to insufficient insertion, resulting in a contact failure.

ENGLISH

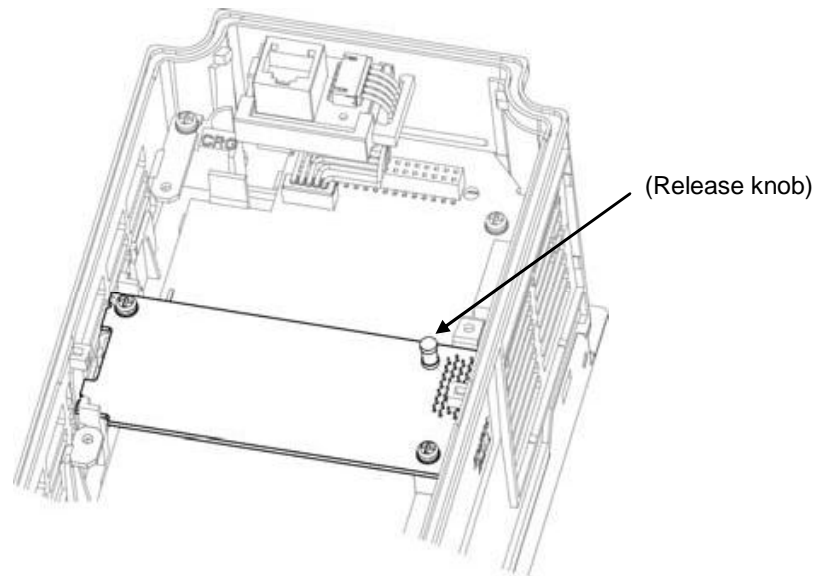

Figure 3.3 Mounting Completed (on B-port)

3.2 Removing the Communications Card

Remove the two screws that secure the communications card and pull the release knob (shown above) to take the communications card out of the inverter.

Chapter 4 WIRING AND CABLING

⚠ WARNING ⚠

“ Before starting installation and wiring, turn OFF the power and wait at least five minutes for inverters with a capacity of 22 kW or below, or at least ten minutes for inverters with a capacity of 30 kW or above. Make sure that the LED monitor and charging lamp are turned OFF. Further, make sure, using a multimeter or a similar instrument, that the DC link bus voltage between the terminals P(+) and N(-) has dropped to the safe level (+25 VDC or below).

“ Qualified electricians should carry out wiring.

Otherwise, an electric shock could occur.

“ In general, the covers of the control signal wires are not specifically designed to withstand a high voltage (i.e., reinforced insulation is not applied). Therefore, if a control signal wire comes into direct contact with a live conductor of the main circuit, the insulation of the cover might break down, which would expose the signal wire to a high voltage of the main circuit. Make sure that the control signal wires will not come into contact with live conductors of the main circuit.

Failure to observe this precaution could cause an electric shock or an accident.

⚠ CAUTION ⚠

Noise may be emitted from the inverter, motor and wires. Take appropriate measures to prevent the nearby sensors and devices from malfunctioning due to such noise.

An accident could occur.

4.1 Basic Connection Diagram

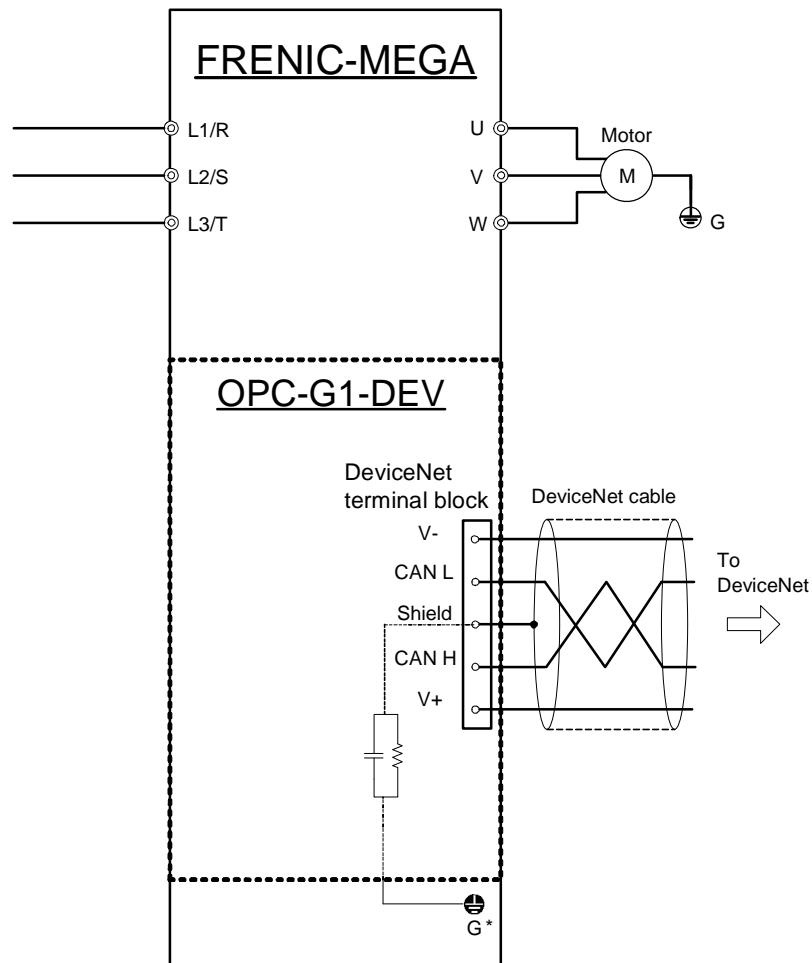

* Mounting the communications card connects to the grounding \oplus G.

Figure 4.1 Basic Connection Diagram

4.2 Wiring for DeviceNet Terminal Block

- (1) To connect the communications card to DeviceNet, use a DeviceNet thin cable complying with the DeviceNet specifications. Also observe the wiring lengths specified in the DeviceNet specifications.

Tip The recommended DeviceNet cable is TDN24U made by SWCC Showa Device Technology, Co., Ltd.

 Proper installation of the cable requires specialist knowledge. Be sure to refer to the DeviceNet specifications or DeviceNet construction manual (both are published by ODVA) beforehand.

- (2) Wiring around the DeviceNet terminal block (TERM1)

The terminal block uses a pluggable 5-pin connector as shown in Figure 4.2. It has five labels corresponding to the five pins. Each label has an ID color corresponding to the wire (core) to be connected to its pin. Make sure that the ID colors of the wires and labels match. Table 4.1 shows the correspondence between the pin numbers and the ID colors.

A typical connector that matches this terminal block is Phoenix Contact MSTB 2.5/5-ST-5.08 AU.

Note The Phoenix Contact TMSTBP 2.5/5-ST-5.08 AU and TFKC 2.5/5-STF-5.08 AU (spring-cage connection type) connectors for multidrop connection cannot be used.

Table 4.1 Pin Layout on DeviceNet Terminal Block

Pin #	ID Color of Wire Sheath	Pin Assignment	Description
1	Black	V-	Power supply (24 VDC, - side)
2	Blue	CANL	Signal line (- side)
3	Metallic	SD	Cable shield
4	White	CANH	Signal line (+ side)
5	Red	V+	Power supply (24 VDC, + side)

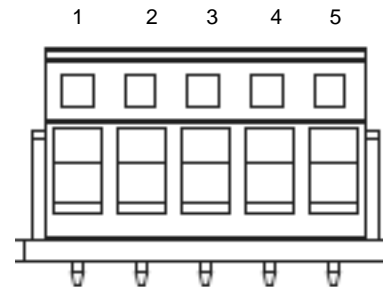

Figure 4.2 Connectors on the DeviceNet Terminal Block

Table 4.2 lists the recommended terminal screw size and its tightening torque, and Figure 4.3 shows the recommended strip length of the cable wire end.

Table 4.2 Recommended Tightening Torque of the Terminal Screws for the DeviceNet Terminal Block

Terminal screw size	Tightening torque
M3	0.5 to 0.6 N·m

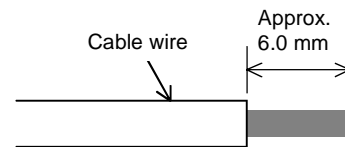

Figure 4.3 Recommended Strip Length of the Cable Wire End for Terminal Connection

- (3) Terminating resistor

DeviceNet requires a terminating resistor to be installed externally on each end of the trunk line. Check that the trunk line is terminated on both ends; if not, install a terminating resistor(s) on the missing end(s).

Note Terminating resistors do not come with the communications card. A pair of resistors with the following specifications is separately necessary.

121 ohm $\pm 1\%$, 1/4 watt, metal-film resistor

4.3 Wiring to Inverter

Note Route the wiring of the DeviceNet cable as far from the wiring of the main circuit as possible. Otherwise electric noise may cause malfunctions.

Note Route the wires, taking care not to let them go over the control PCB, as shown in Figure 4.4. Otherwise, malfunctions may occur.

~ For inverters with a capacity of 22 kW or below

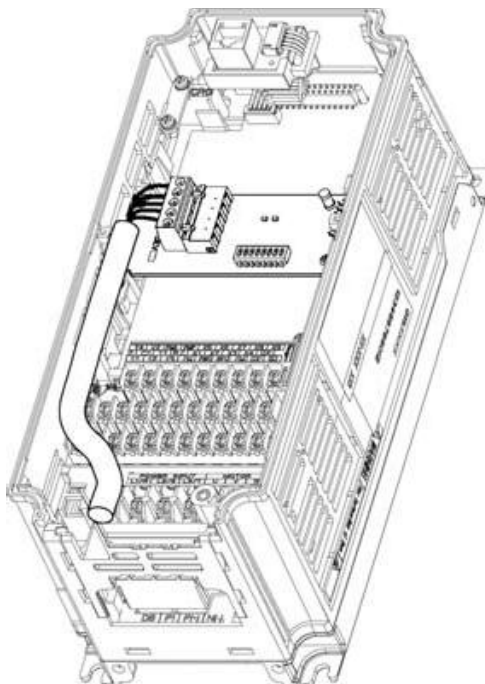

* Pass the wires from the communications card between the control circuit terminal block and the front cover.

In the case of 0.4 kW

~ For inverters with a capacity of 30 kW or above

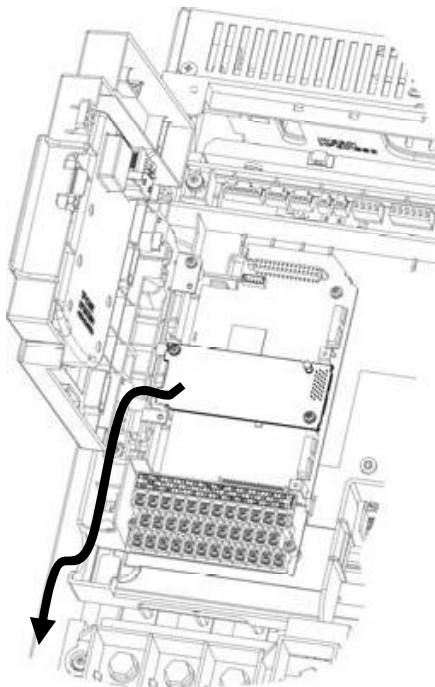

In the case of 75 kW

Figure 4.4 Examples of Wiring

Chapter 5 CONFIGURING INVERTER'S FUNCTION CODES FOR DeviceNet COMMUNICATION

Before starting DeviceNet communication between the inverter equipped with the communications card and the DeviceNet master device, configure the inverter's function codes listed in Table 5.1.

Table 5.2 lists other related function codes to be configured if necessary.

Table 5.1 Inverter's Function Codes for DeviceNet Communication

Function codes	Description	Factory default setting	Function code data	Remarks															
o31 *1	Select output assembly instance (From master to inverter)	0	Available data is: 20 : Basic speed control output 0, 21 : Extended speed control output 100 : Fuji drive assembly output 102 : User defined assembly output 104 : Request for Access to Function Codes	See Chapter 7. The factory default is "Extended speed control output."															
o32 *1	Select input assembly instance (From inverter to master)	0	Available data is: 70 : Basic speed control input 0, 71 : Extended speed control input 101 : Fuji drive assembly input 103 : User defined assembly input 105 : Response to Function Codes Access Request	See Chapter 7. The factory default is "Extended speed control input."															
y98 *2	Select run/frequency command source	0	Available data is: <table border="1" style="margin-left: 20px;"> <thead> <tr> <th></th> <th>Frequency command</th> <th>Run command</th> </tr> </thead> <tbody> <tr> <td>0</td> <td>Inverter</td> <td>Inverter</td> </tr> <tr> <td>1</td> <td>DeviceNet</td> <td>Inverter</td> </tr> <tr> <td>2</td> <td>Inverter</td> <td>DeviceNet</td> </tr> <tr> <td>3</td> <td>DeviceNet</td> <td>DeviceNet</td> </tr> </tbody> </table>		Frequency command	Run command	0	Inverter	Inverter	1	DeviceNet	Inverter	2	Inverter	DeviceNet	3	DeviceNet	DeviceNet	If there is no special problem with your system, setting y98 = 3 is recommended.
	Frequency command	Run command																	
0	Inverter	Inverter																	
1	DeviceNet	Inverter																	
2	Inverter	DeviceNet																	
3	DeviceNet	DeviceNet																	

*1 After configuring the function code o31 or o32, restart the inverter to validate the new settings. For details about these function codes, refer to Chapter 7 "I/O MESSAGE."

Input and output assembly instances should not be necessarily set to the same instance type. (Ex. Output assembly instance = Extended speed control output, Input assembly instance = User defined assembly input.)

*2 If the extended speed control output is selected (o31 = 0 or 21), only bit operation in the instance can select the run/frequency command sources, so no prior configuration of y98 is required. For details, refer to Section 7.2.2 "Extended Speed Control Instance."

Table 5.2 Other Related Function Codes

Function codes	Description	Factory default setting	Function code setting range	Remarks
o27 *1	Select the inverter's operation mode to apply when a DeviceNet communications error occurs.	0	0 to 15	
o28 *1	Set the operation timer to apply when a DeviceNet communications error occurs.	0.0 s	0.0 to 60.0 s	
o40 to o43 *2	Assign the function code writing data cyclically.	0 (No assignment)	0000 to FFFF (hex)	Valid only when "User defined assembly input/output" is selected (o31 = 102, o32 = 103).
o48 to o51 *2	Assign the function code reading data cyclically.	0 (No assignment)	0000 to FFFF (hex)	

*1 For details about function codes o27 and o28, refer to Chapter 9 "INVERTER REACTION TO DeviceNet COMMUNICATIONS ERRORS."

*2 For details about function codes o40 to o43 and o48 to o51, refer to Section 7.2.4 "User Defined Assembly Instance."

Chapter 6 ESTABLISHING A DeviceNet COMMUNICATIONS LINK

This chapter guides you to establish a DeviceNet communications link in I/O Message transmission between the DeviceNet master and the inverter (slave).

 I/O Message is a communication process that cyclically transfers data between the DeviceNet master and slave. For details about I/O Message, refer to Chapter 7 "I/O MESSAGE."

- (1) Configure the inverter's function codes described in Chapter 5.
 - Set the I/O assembly instances with the inverter's function codes o31 and o32. It is not necessary to set the same type of I/O assembly instances to input and output.
 - Configure the inverter's function codes o27 and o28 with your need. If the instances for user defined assemblies have been set, configure the function codes o40 to o43 and o48 to o51.
 - After completion of the settings above, turn OFF the inverter and the communications card in order to validate the settings.

 For details about the inverter's function codes o31, o32, o40 to o43, and o48 to o51, refer to Chapter 7 "I/O MESSAGE."

- (2) Set up the DeviceNet master (PLC, PC tool, or Configurator).
 - Set a unique MAC ID (node address), so that it does not coincide with any other nodes.
 - Set the baud rate. Make sure that all the nodes have the same baud rate.
 - If necessary, install the EDS file of the communications card to the setup tool of the master.
 - Allocate an I/O area corresponding to the I/O assembly instance set for the communications card. The I/O area is either 2 words or 4 words in length.
 - Specify the I/O connection type--"Poll" and "Change of State." Specify the communications scan cycle if necessary.

 **Note** The communications scan cycle to the communications card should be 10 ms or longer. If a single inverter is connected to a master, the cycle should be 10 ms or longer; if two inverters are connected, 5 ms or longer. To minimize the data conflicts and maximize the system reliability, the cycle of 20 ms or longer is recommended.

 **Tip** The Electric Data Sheet (EDS) file defines parameters on the inverter. Using it quickly accesses the desired parameters. For the communications card, the file makes it easier to access the inverter's function codes. For how to obtain the EDS file, refer to Section 1.1 "Acceptance Inspection."

 For details about the setup procedure of the DeviceNet master, refer to the user's manual of the corresponding master.

- (3) Configure the node address and baud rate with the DIP switch on the communications card.
 - Before accessing the DIP switch, make sure that both the inverter and the communications card are turned OFF.
 - Set a unique node address, so that it does not coincide with any other nodes.
 - Set the same baud rate as the master.

 For details about setting the DIP switch, refer to Section 2.2 "DIP Switch."

- (4) Have an I/O connection request issued from the DeviceNet master.
 - Turn ON the inverter and the communications card.
 - Have an I/O connection request issued from the DeviceNet master.

 For details about issuing I/O connection requests from the master, refer to the user's manual of the connected master device. In many PLCs, an I/O connection request is automatically issued at the time of powering ON.

- (5) Start I/O Message.

If both the master and the communications card have been set correctly and the wiring is proper, I/O message connection will be established in response to the connection request and data transmission starts. At this stage, the MS and NS LEDs on the communications card light in green. It is ready to control the inverter according to the specified I/O assembly instances.

Chapter 7 I/O MESSAGE

7.1 Overview

I/O Message is a communication process that cyclically transfers data between the DeviceNet master and the inverter.

The communications card supports two types of I/O Message connections--Poll and Change-of-State connections. It also supports five types of I/O assembly instances as data formats in I/O Message, as listed in Table 7.1. One of the five instances can be selected for input and output each.

The I/O assembly instances should be specified using inverter's function codes o31 and o32.



 Poll connections allow the master to periodically poll the inverter for data. In response to the request, the inverter sends data. In Change-of-State connections, the inverter sends data only when the data has changed.

Table 7.1 Configuring I/O Assembly Instances

Function code o31, o32	Type	Instance ID	Description	Length (words)
o31=20	Output (from master to inverter)	20	Basic Speed Control Output	2
o31=0 or 21		21	Extended Speed Control Output (Factory default)	2
o31=100		100	Fuji Drive Assembly Output	2
o31=102		102	User Defined Assembly Output	4
o31=104		104	Request for Access to Function Codes	4
o32=70	Input (from inverter to master)	70	Basic Speed Control Input	2
o32=0 or 71		71	Extended Speed Control Input (Factory default)	2
o32=101		101	Fuji Drive Assembly Input	2
o32=103		103	User Defined Assembly Input	4
o32=105		105	Response to Function Codes Access Request	4

 If the "Request for Access to Function Codes" (o31=104) is selected for output, it is recommended that the "Response to Function Codes Access Request" (o32=105) be selected for input in order to confirm that data is correctly written in the function code. Other input and output assembly instances should not be necessarily set to the same instance type.

(Ex. The following combination is also available:

Output assembly instance = Extended speed control output

Input assembly instance = User defined assembly input.)

 Once you have modified the o31, o32, o40 to o43 and o48 to o51 data, be sure to restart the inverter or use the RESET service to validate the new settings.

 For details about the RESET service, refer to the DeviceNet's or Configurator's manual.

 To stop auto tuning triggered via DeviceNet halfway, use the **BX** terminal command assigned to any of digital input terminals ([X1] to [X9], [FWD] and [REV]). In the FRENIC-MEGA series of inverters, **BX** is assigned to digital input terminal [X7] by factory default.

 Whether the inverter has terminals [X8] and [X9] depends upon the product specifications of the FRENIC-MEGA inverter. For details, refer to the FRENIC-MEGA Instruction Manual, Chapter 5 "FUNCTION CODES."

7.2 I/O Assembly Instances: Selection and Setup

7.2.1 Basic Speed Control Instance

(1) Output (from master to inverter): o31=20

Instance	byte	bit 7	bit 6	bit 5	bit 4	bit 3	bit 2	bit 1	bit 0
20	0	-	-	-	-	-	Fault Reset	-	Run Forward
	1	(Fixed at 00)							
	2	Speed Reference (lower byte) (r/min)							
	3	Speed Reference (upper byte) (r/min)							

Run Forward: 1 = Run forward command

Fault Reset: 1 = Reset the alarm condition

Speed Reference: Speed command (in r/min)

(2) Input (from inverter to master): o32=70

Instance	byte	bit 7	bit 6	bit 5	bit 4	bit 3	bit 2	bit 1	bit 0
70	0	-	-	-	-	-	Running Forward	-	Faulted
	1	(Fixed at 00)							
	2	Speed Actual (lower byte) (r/min)							
	3	Speed Actual (upper byte) (r/min)							

Faulted: 1 = The inverter has (and remains) tripped

Running Forward: 1 = The motor is running forward.

Speed Actual: Actual rotation speed (in r/min)

7.2.2 Extended Speed Control Instance (factory default)

(1) Output (from master to inverter): o31=0 or 21

Instance	byte	bit 7	bit 6	bit 5	bit 4	bit 3	bit 2	bit 1	bit 0
21	0	-	NetRef	NetCtrl	-	-	Fault Reset	Run Reverse	Run Forward
	1	(Fixed at 00)							
	2	Speed Reference (lower byte) (r/min)							
	3	Speed Reference (upper byte) (r/min)							

Run Forward: 1 = Run forward command

Run Reverse: 1 = Run reverse command

Fault Reset: 1 = Reset the alarm condition

NetCtrl: 1 = Request for enabling run command sent from DeviceNet;
0 = Request for enabling run command sent from other than DeviceNet

NetRef: 1 = Request for enabling speed reference sent from DeviceNet;
0 = Request for enabling speed reference sent from other than DeviceNet

Speed Reference: Speed reference (in r/min)

(2) Input (from inverter to master): o32=0 or 71

Instance	byte	bit 7	bit 6	bit 5	bit 4	bit 3	bit 2	bit 1	bit 0
71	0	At Reference	Ref FromNet	Ctrl FromNet	Ready	Running Reverse	Running Forward	-	Faulted
	1	Drive State							
	2	Speed Actual (lower byte) (r/min)							
	3	Speed Actual (upper byte) (r/min)							

Faulted: 1 = The inverter has (and remains) tripped.

Running Forward: 1 = The motor is running forward.

Running Reverse: 1 = The motor is running backward (in the reverse direction).

Ready: 1 = Ready to run

CtrlFromNet: 1 = Run command sent from DeviceNet being enabled
0 = Run command sent from other than DeviceNet being enabled

RefFromNet: 1 = Speed reference sent from DeviceNet being enabled
0 = Speed reference sent from other than DeviceNet being enabled

At Reference: 1 = The motor is running at the reference speed.

Drive State: 1 = Startup, 2 = Not Ready, 3 = Ready, 4 = Enabled, 5 = Stopping,
6 = Fault stop, 7 = Faulted

Speed Actual: Actual rotation speed (in r/min)

7.2.3 Fuji Drive Assembly Instance

(1) Output (from master to inverter): o31=100

Instance	byte	bit 7	bit 6	bit 5	bit 4	bit 3	bit 2	bit 1	bit 0
100	0	X6	X5	X4	X3	X2	X1	REV	FWD
	1	RST	XR	XF	-	-	X9 *	X8 *	X7
	2	Frequency command p.u. (lower byte)							
	3	Frequency command p.u. (upper byte)							

FWD: 1 = Run forward command

REV: 1 = Run reverse command

X1 to X9: Communication terminal block command
(The function to be performed is specified by E01 to E09).

XF, XR: Communication terminal block command
(The function to be performed is specified by E98 and E99).

RST: 1 = Reset the alarm (fault) condition.

Frequency command p.u.: Specifies the ratio of the frequency relative to the maximum frequency (defined by F03 in Hz) being assumed as 20000.

$$\text{Frequency command p.u.} = \text{Frequency command (Hz)} / \text{F03 (Hz)} \times 20000.$$

* Whether the inverter has terminals [X8] and [X9] depends upon the product specifications of the FRENIC-MEGA inverter. For details, refer to the FRENIC-MEGA Instruction Manual, Chapter 5 "FUNCTION CODES."

(2) Input (from inverter to master): o32=101

Instance	byte	bit 7	bit 6	bit 5	bit 4	bit 3	bit 2	bit 1	bit 0
101	0	VL	TL	NUV	BRK	INT	EXT	REV	FWD
	1	BUSY	ERR	-	RL	ALM	DEC	ACC	IL
	2	Frequency output p.u. (lower byte)							
	3	Frequency output p.u. (upper byte)							

FWD: During forward rotation

REV: During reverse rotation

EXT: During DC braking (or during pre-exciting)

INT: Inverter shut down

BRK: During braking

NUV: DC link bus voltage established (0 = undervoltage)

TL: During torque limiting

VL: During voltage limiting

IL: During current limiting

ACC: During acceleration

DEC: During deceleration

ALM: Alarm relay (for any fault)

RL: Run or speed command from communication enabled

ERR: Function code access error

BUSY: During function code data writing

Frequency output p.u.: Output frequency monitored, relative to the maximum frequency (defined by F03 in Hz) being assumed as 20000.

7.2.4 User Defined Assembly Instance

(1) Output (from master to inverter): o31=102

User Defined Assembly Output offers a format which allows the user to freely set or modify the function code defined by the user using the function codes o40 to o43 beforehand. Four function codes are provided for the user to define.

Instance	byte	bit 7	bit 6	bit 5	bit 4	bit 3	bit 2	bit 1	bit 0
102	0	User-defined function code 1 (write) (lower byte) (data of function code specified by o40)							
	1	User-defined function code 1 (write) (upper byte) (data of function code specified by o40)							
	2	User-defined function code 2 (write) (lower byte) (data of function code specified by o41)							
	3	User-defined function code 2 (write) (upper byte) (data of function code specified by o41)							
	4	User-defined function code 3 (write) (lower byte) (data of function code specified by o42)							
	5	User-defined function code 3 (write) (upper byte) (data of function code specified by o42)							
	6	User-defined function code 4 (write) (lower byte) (data of function code specified by o43)							
	7	User-defined function code 4 (write) (upper byte) (data of function code specified by o43)							

User-defined function code 1 (write): Write data for the function code specified by o40

User-defined function code 2 (write): Write data for the function code specified by o41

User-defined function code 3 (write): Write data for the function code specified by o42

User-defined function code 4 (write): Write data for the function code specified by o43

 **Note** If the same function code is assigned to more than one out of o40 to o43 codes, only the one assigned to the smallest "o" code number becomes effective, and all the rest will be treated as "not assigned." (For example, if the same function code is assigned to o40 and o43, o40 becomes effective and o43 does not.)

 **Note** Just like assignment of the same function code above, if S01, S05, and S19 are assigned to o40 to o43 at the same time, only the one assigned to the smallest "o" code number becomes effective, and all the rest will be treated as "not assigned." (For example, if o40 = S05, o41 = S19, and o42 = S01, only S05 becomes effective.)

 For details about communication-dedicated function codes (S, M, W, X and Z codes), refer to the RS-485 Communication User's Manual, Chapter 5, Section 5.2 "Data Formats."

 For details about configuring the inverter's function codes using o40 to o43, refer to the next page.

(2) Input (from inverter to master): o32=103

User Defined Assembly Input offers a format which allows the user to monitor the function codes defined by the user using the function codes o48 to o51 beforehand. Four function codes are provided for the user to define.

Instance	byte	bit 7	bit 6	bit 5	bit 4	bit 3	bit 2	bit 1	bit 0
103	0	User-defined function code 1 (read) (lower byte) (data of function code specified by o48)							
	1	User-defined function code 1 (read) (upper byte) (data of function code specified by o48)							
	2	User-defined function code 2 (read) (lower byte) (data of function code specified by o49)							
	3	User-defined function code 2 (read) (upper byte) (data of function code specified by o49)							
	4	User-defined function code 3 (read) (lower byte) (data of function code specified by o50)							
	5	User-defined function code 3 (read) (upper byte) (data of function code specified by o50)							
	6	User-defined function code 4 (read) (lower byte) (data of function code specified by o51)							
	7	User-defined function code 4 (read) (upper byte) (data of function code specified by o51)							

User-defined function code 1 (read): Monitored value of the function code specified by o48

User-defined function code 2 (read): Monitored value of the function code specified by o49

User-defined function code 3 (read): Monitored value of the function code specified by o50

User-defined function code 4 (read): Monitored value of the function code specified by o51



Even modifying S05 or S19 data reflects its change into S01 only. To monitor speed in frequency or r/min., therefore, select communication-dedicated function code M09 or M78.



For details about configuring the inverter's function codes using o48 to o51, see item (3) below.



Each function code defined has its own data format. For details about the data format of each code, refer to the RS-485 Communication Use's Manual, Chapter 5, Section 5.2 "Data Formats."

(3) Configuring inverter's function codes o40 to o43 and o48 to o51

Specifying the function code type (shown in Table 7.2) and number in a 4-digit hexadecimal notation.

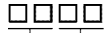

Function code number (hexadecimal)

Function code type (in accordance with Table 7.2)

Table 7.2 Function Code Type

Type	Type Code	Function Code	Type	Type Code	Function Code
S	2 02h	Command/function data	J	14 0Eh	Application function 1
M	3 03h	Monitored data	y	15 0Fh	Link function
F	4 04h	Fundamental function	W	16 10h	Monitored data 2
E	5 05h	Terminal function	X	17 11h	Alarm 1
C	6 06h	Control function	Z	18 12h	Alarm 2
P	7 07h	Motor 1 parameters	b	19 13h	Motor 3 parameters
H	8 08h	High performance function	r	12 0Ch	Motor 4 parameters
A	9 09h	Motor 2 parameters	d	20 14h	Application function 2
o	10 0Ah	Optional function			

Example: For F26: F ⇒ Type Code 04
 26 ⇒ 1A (hexadecimal) } 04 1A

ENGLISH

7.2.5 Access to Function Codes

(1) Request for access to function codes (from master to inverter): o31=104

This instance is provided to read or write function codes from/into the inverter.

Instance	byte	bit 7	bit 6	bit 5	bit 4	bit 3	bit 2	bit 1	bit 0	
104	0	X6	X5	X4	X3	X2	X1	REV	FWD	
	1	RST	XR	XF	Access Code		X9 *	X8 *	X7	
	2	User-defined function code 1 (write) (lower byte) (data of function code specified by o40)								
	3	User-defined function code 1 (write) (upper byte) (data of function code specified by o40)								
	4	Access to function code (number)								
	5	Access to function code (group)								
	6	Access to function code (write data: lower byte)								
	7	Access to function code (write data: upper byte)								

FWD: 1 = Run forward command

REV: 1 = Run reverse command

X1 to X9: Communication terminal block command
(The terminal function is specified by E01 to E09).

XF, XR: Communication terminal block command
(The terminal function is specified by E98 and E99).

RST: 1 = Reset the alarm (fault) condition.

Access Code: 00, 11 = Disable, 01 = Read function codes from inverter,
10 = Write function codes into inverter

User-defined function code 1: Specify the data of function code previously specified by o40
(For details about how to specify data, refer to Section 7.2.4 "User Defined Assembly Instance.")

Access to function code (number): Numeral component of function code to access

Access to function code (group): Type of function code to access (listed in Table 7.2)

Access to function code (write data): Data to write into function code specified by bytes 4 and 5

* Whether the inverter has terminals [X8] and [X9] depends upon the product specifications of the FRENIC-MEGA inverter. For details, refer to the FRENIC-MEGA Instruction Manual, Chapter 5 "FUNCTION CODES."

 Assigning any of communication-dedicated function codes S01, S06, and S19 to inverter's function code o40 enables bytes 2 and 3 of "Request for access to function codes" instance to specify speed.

 Communication-dedicated function code S06 cannot be assigned to bytes 4 and 5. Instead, use bytes 0 and 1 that have the similar function.

 For details about communication-dedicated function codes (S, M, W, X and Z codes), refer to the RS-485 Communication User's Manual, Chapter 5, Section 5.2 "Data Formats."

(2) Response to request for access to function codes (from inverter to master): 032=105

This instance is provided to verify the read/write result of function codes.

Instance	byte	bit 7	bit 6	bit 5	bit 4	bit 3	bit 2	bit 1	bit 0	
105	0	VL	TL	NUV	BRK	INT	EXT	REV	FWD	
	1	BUSY	ERR	ACK	RL	ALM	DEC	ACC	IL	
	2	User-defined function code 1 (read) (lower byte) (data of function code specified by o48)								
	3	User-defined function code 1 (read) (upper byte) (data of function code specified by o48)								
	4	Access to function code (number)								
	5	Access to function code (group)								
	6	Access to function code (read data/error code: lower byte)								
	7	Access to function code (read data/error code: upper byte)								

ACK: 1=Normal response to write/read request

ERR: 1=Abnormal response to write/read request
(Error code output to bytes 6 and 7)

User-defined function code 1: Monitored data of function code specified by o48
(e.g., speed monitor M06, M09, M79. etc.)

Access to function code (number): Value specified by "Request for access to function codes" instance

Access to function code (group): Value specified by "Request for access to function codes" instance

Access to function code (read data): Value read from the specified function code when requested read/write is normal

Access to function code (error code): Error code displayed (see Table 7.3) when requested read/write is abnormal

Others: Same as for input instance 101.

Table 7.3 Error Code List

Error code		Error name	Description
Upper	Lower		
1F	02	No function code (in writing)	Attempted to write to a nonexistent function code.
	03	Function code not allowed to change	Attempted to write to a read-only function code.
	06	Not allowed to change in running	Attempted to write to a function code not allowed to change when the inverter is running.
	07	Not allowed to change with X terminal being ON	Attempted to write to a function code not allowed to change when X terminal is ON.
	08	Data entry range error	Attempted to write data out of the range.
	0F	Function code data being written	Requested to write to a function code being written.
	21	No function code (in reading)	Attempted to read from a nonexistent function code.

(3) Examples for writing and reading to/from function codes

Normal writing and reading

This example shows communication data for writing to function code F03 (=0403h) to change the data from factory default 60.0 Hz (=0258h) to 300.0 Hz (=0BB8h) and then reading from F03. (The following data is expressed in hexadecimal.)

- ① Select the inverter's function code F03.

Write: **00 00 00 00 03 04 00 00**

Read: **28 10 00 00 00 00 00 00**

- ② Input data to F03.

Write: **00 00 00 00 03 04 B8 0B**

Read: **28 10 00 00 00 00 00 00**

- ③ Write data into F03.

Write: **00 10 00 00 03 04 B8 0B**

Read: **28 10 00 00 03 04 B8 0B**

- ④ Read from F03.

Write: **00 08 00 00 03 04 00 00**

Read: **28 10 00 00 03 04 B8 0B**

Reading/writing error

This example shows communication data that returns an error code since writing and reading to/from nonexistent function code F99 (=0463h) is attempted.

- ① Select the inverter's function code F99.

Write: **00 00 00 00 63 04 00 00**

Read: **28 10 00 00 00 00 00 00**

- ② Write data into F99.

Write: **00 10 00 00 63 04 00 00**

Read: **28 50 00 00 63 04 02 1F**

- ③ Read from F99.

Write: **00 08 00 00 63 04 00 00**

Read: **28 50 00 00 63 04 21 1F**

7.3 An Example of Actual I/O Communication Data

7.3.1 Extended Speed Control Instance

Presented herein is an actual communication data in the format of Extended Speed Control Instance, the factory default format.

(1) Driving pattern example

Given below is an example of the driving pattern for controlling the inverter. Its corresponding I/O data is shown in (2) below.

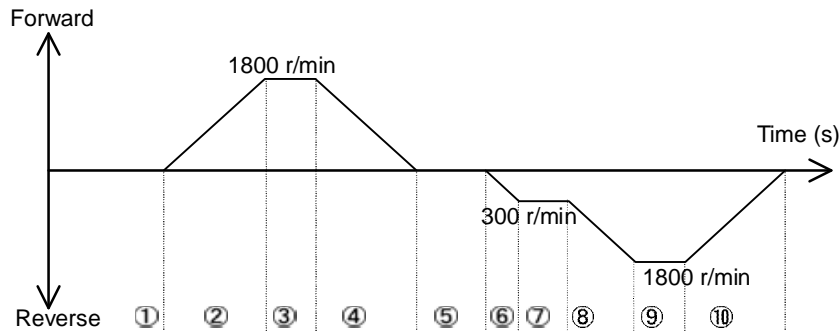

Figure 7.1 Driving Pattern

(2) Description of I/O Data (The I/O data are in hexadecimal notation.)

- ① Request: Run command is OFF. Speed command = 1800 r/min (= 0708h). The run command and speed command via DeviceNet are enabled.
60 00 08 07
Response: Stopping. The inverter is ready.
70 03 00 00
- ② Request: Run forward command. Speed command = 1800 r/min (= 0708h). The run command and speed command via DeviceNet are enabled.
61 00 08 07
Response: The motor is running forward and accelerating. The actual speed is increasing.
74 04 ** **
- ③ Request: Run forward command. Speed command = 1800 r/min (= 0708h). The run command and speed command via DeviceNet are enabled.
61 00 08 07
Response: Running forward. The actual speed has reached the Reference
F4 04 08 07
- ④ Request: Run command is OFF. Speed command = 1800 r/min (= 0708h). The run command and speed command via DeviceNet are enabled.
60 00 08 07
Response: The motor is running forward and decelerating. The actual speed is decreasing.
74 05 ** **
- ⑤ Request: No run command. Speed command is changed to 300 r/min (= 012Ch). The run command and speed command via DeviceNet are enabled.
60 00 2C 01
Response: Stopping. The inverter is ready.
70 03 00 00
- ⑥ Request: Run reverse command. Speed command = 300 r/min (= 012Ch). The run command and speed command via DeviceNet are enabled.
62 00 2C 01
Response: The motor is running backward (in the reverse direction) and accelerating. The actual speed is increasing.
78 04 ** **

- ⑦ Request: Run reverse command. Speed command = 300 r/min (= 012Ch). The run command and speed command via DeviceNet are enabled.
62 00 2C 01
Response: Running in the reverse direction. The actual speed has reached Reference
F8 04 2C 01
- ⑧ Request: Run reverse command. Speed command is changed to 1800 r/min (= 0708h). The run command and speed command via DeviceNet are enabled.
62 00 08 07
Response: The motor is running backward (in the reverse direction) and accelerating. The actual speed is increasing.
78 04 ** **
- ⑨ Request: Run reverse command. Speed command = 1800 r/min (= 0708h). The run command and speed command via DeviceNet are enabled.
62 00 08 07
Response: Running in the reverse direction. The actual speed has reached Reference
F8 04 08 07
- ⑩ Request: Run command is OFF. Speed command = 1800 r/min (= 0708h). The run command and speed command via DeviceNet are enabled.
60 00 08 07
Response: The motor is running backward (in the reverse direction) and decelerating. The actual speed is decreasing.
78 05 ** **

7.4 I/O Assembly Instances Assigned to Word Variables (For reference)

Some masters assign an I/O assembly instance area to a word variable. Shown below are the formats for each I/O assembly instance assigned to a word variable. For details about the definition of bits in the formats, refer to Section 7.2 "I/O Assembly Instances: Selection and Setup."

7.4.1 Basic Speed Control Instance

(1) Output (from master to inverter): o31=20

word	bit 15	14	13	12	11	10	9	8	7	6	5	4	3	2	1	bit 0
0	-	-	-	-	-	-	-	-	-	-	-	-	-	Fault Reset	-	Run Forward
1	Speed Reference (r/min)															

(2) Input (from inverter to master): o32=70

word	bit 15	14	13	12	11	10	9	8	7	6	5	4	3	2	1	bit 0
0	-	-	-	-	-	-	-	-	-	-	-	-	-	Running Forward	-	Faulted
1	Speed Actual (r/min)															

7.4.2 Extended Speed Control Instance

(1) Output (from master to inverter): o31=0 or 21

word	bit 15	14	13	12	11	10	9	8	7	6	5	4	3	2	1	bit 0
0	-	-	-	-	-	-	-	-	-	Net Ref	Net Ctrl	-	-	Fault Reset	Run Reverse	Run Forward
1	Speed Reference (r/min)															

(2) Input (from inverter to master): o32=0 or 71

word	bit 15	14	13	12	11	10	9	8	7	6	5	4	3	2	1	bit 0
0	-	-	-	-	-	-	-	-	At Reference	*2	*1	Ready	Running Reverse	Running Forward	-	Faulted
1	Speed Actual (r/min)															

*1 CtrlFromNet

*2 RefFromNet

7.4.3 Fuji Drive Assembly Instance

(1) Output (from master to inverter): o31=100

word	bit 15	14	13	12	11	10	9	8	7	6	5	4	3	2	1	bit 0
0	RST	XR	XF	-	-	X9 *	X8 *	X7	X6	X5	X4	X3	X2	X1	REV	FWD
1	Frequency command p.u.															

* Whether the inverter has terminals [X8] and [X9] depends upon the product specifications of the FRENIC-MEGA inverter. For details, refer to the FRENIC-MEGA Instruction Manual, Chapter 5 "FUNCTION CODES."

(2) Input (from inverter to master): o32=101

word	bit 15	14	13	12	11	10	9	8	7	6	5	4	3	2	1	bit 0
0	BUSY	ERR	-	RL	ALM	DEC	ACC	IL	VL	TL	NUV	BRK	INT	EXT	REV	FWD
1	Frequency command p.u.															

7.4.4 User Defined Assembly Instance

(1) Output (from master to inverter): o31=102

word	bit 15	14	13	12	11	10	9	8	7	6	5	4	3	2	1	bit 0
0	User-defined function code 1 (write) (data of function code specified by o40)															
1	User-defined function code 2 (write) (data of function code specified by o41)															
2	User-defined function code 3 (write) (data of function code specified by o42)															
3	User-defined function code 4 (write) (data of function code specified by o43)															

(2) Input (from inverter to master): o32=103

word	bit 15	14	13	12	11	10	9	8	7	6	5	4	3	2	1	bit 0
0	User-defined function code 1 (read) (data of function code specified by o48)															
1	User-defined function code 2 (read) (data of function code specified by o49)															
2	User-defined function code 3 (read) (data of function code specified by o50)															
3	User-defined function code 4 (read) (data of function code specified by o51)															

7.4.5 Access to Function Codes

(1) Request for access to function codes (from master to inverter): o31=104

word	bit 15	14	13	12	11	10	9	8	7	6	5	4	3	2	1	bit 0
0	RST	XR	XF	Access code	X9 *	X8 *	X7	X6	X5	X4	X3	X2	X1	REV	FWD	
1	User-defined function code 1 (write) (data of function code specified by o40)															
2	Access to function code (group) + Access to function code (number) (Refer to Table 7.2.)															
3	Access to function code (write data)															

* Whether the inverter has terminals [X8] and [X9] depends upon the product specifications of the FRENIC-MEGA inverter. For details, refer to the FRENIC-MEGA Instruction Manual, Chapter 5 "FUNCTION CODES."

(2) Response to request for access to function codes (from inverter to master): o32=105

word	bit 15	14	13	12	11	10	9	8	7	6	5	4	3	2	1	bit 0
0	BUSY	ERR	ACK	RL	ALM	DEC	ACC	IL	VL	TL	NUV	BRK	INT	EXT	REV	FWD
1	User-defined function code 1 (read) (data of function code specified by o48)															
2	Access to function code (group) + Access to function code (number) (Refer to Table 7.2.)															
3	Access to function code (read data/error code)															

Chapter 8 EXPLICIT MESSAGE

8.1 Overview

Explicit Message is a communication process that accesses DeviceNet variables at arbitrary (event-driven) timing. Using the communications card is capable of accessing not only standard DeviceNet variables but also all inverter's function codes. Explicit Message lacks realtime performance, but it allows many variables to be set or referred to. It is, therefore, suited for initial setting.

 Refer to the user's manual of the connected master for Explicit Message.



- Variables usable in Explicit Message are grouped using three codes--Class (major key), Instance (medium key) and Attribute (minor key). These three codes should be used for specifying a variable.
- A group of all variables contained in Class is called "Object."

8.2 Objects to be Used in Explicit Message

This section describes objects relating to the communications card and the inverter. Other objects that are automatically executed by the master device are excluded in this manual.

(1) Identity object (Class 01 hex.)

This object refers to the product information of the communications card. It is a group of read-only variables.

Instance	Attribute	Name	Description	Value (hex.)	R/W	Data size
1	01	Vender ID	Manufacturer's ID code	013F (=319): Fuji Electric Group	R	Word
	02	Device Type	Applied device profile	0002: AC drive	R	Word
	03	Product Code	ID code of the communications card	2403	R	Word
	04	Revision	Software version (Major and minor versions)	Display of version Example: 01, 0A (=Ver. 1.10)	R	Byte, Byte
	05	Status	Status of the communications card	Depends on DeviceNet specifications.	R	Word
	06	Serial Number	Serial number of the product	Differs with the product.	R	DWord
	07	Product Name	Model name	OPC-G1-DEV	R	11 bytes

(2) Motor Data object (Class 28 hex.)

This object refers to and sets up the motor rated current and voltage. When Motor 2, 3, or 4 is selected, this object automatically switches to the one for Motor 2, 3, or 4.

 For details about motor switching, refer to the FRENIC-MEGA Instruction Manual, Chapter 5, Section 5.2 "Details of Function Codes."

Instance	Attribute	Name	Description	Value (hex.)	R/W	Data size
1	03	Motor Type	Type of motor to be connected	07: Squirrel-cage, induction motor	R	Byte
	06	Rated Current	Rated current in units of 0.1 A	Depends on the inverter setting.	R/W	Word
	07	Rated Voltage	Rated voltage in units of 1 V (base voltage)	Depends on the inverter setting.	R/W	Word

(3) Control Supervisor object (Class 29 hex.)

This object monitors the current run command settings and the running status of the inverter, and configures the running-related settings.

Instance	Attribute	Name	Description	Value (hex.)	R/W	Data size
1	03	Run1	Run forward command	00: OFF 01: ON	R/W	Byte
	04	Run2	Run reverse command	00: OFF 01: ON	R/W	Byte
	05	NetCtrl	Switching run command source	00: Inverter 01: DeviceNet	R/W	Byte
	06	State	Current inverter status	01: Inverter running 02: Inverter not ready to run 03: Inverter ready to run 04: Inverter running 05: During deceleration 06: Stop due to communication broken 07: Tripped	R	Byte
	07	Running1	Running forward	00: Stopped/Running reverse 01: Running forward	R	Byte
	08	Running2	Running reverse	00: Stopped/Running forward 01: Running reverse	R	Byte
	09	Ready	Inverter ready to run/ Inverter running (Synchronized with State above)	00: State = Value except below 01: State = 03 to 05	R	Byte
	0A	Faulted	Tripped state	00: Not tripped 01: Tripped	R	Byte
	0B	Warning	Warning. Fixed at 0.	00: No warning	R	Byte
	0C	FaultRst	Reset of tripped (alarm) state	00→01: Request for reset	R/W	Byte
	0F	CtrlFromNet	Current run command source	00: Inverter 01: DeviceNet	R	Byte
10	DNFaultMode	Inverter reaction to DeviceNet communications errors	Refer to Chapter 9.	R/W	Byte	

(4) AC/DC Drive object (Class 2A hex.)

This object monitors the current speed command settings and the current speed of the inverter, and configures their related settings. It also monitors the output data issued from the inverter.

Instance	Attribute	Name	Description	Value (hex.)	R/W	Data size
1	03 hex	AtReference	Speed arrival	00: Stopped or Accelerating/ decelerating 01: Speed arrival	R	Byte
	04 hex	NetRef	Switching speed command source	00: Inverter 01: DeviceNet	R/W	Byte
	06 hex	DriveMode	Run mode. Fixed at 0.	00: Unique to vendor	R	Byte
	07 hex	SpeedActual	Speed monitor (r/min)	Actual speed	R	Word
	08 hex	SpeedRef	Speed command (r/min)	-32768 to 32767 r/min	R/W	Word
	09 hex	CurrentActual	Output current (in units of 0.1 A)	Output current	R	Word
	11 hex	OutputVoltage	Output voltage (V)	Output voltage	R	Word
	12 hex	AccelTime	Acceleration time (ms)	0 to 65535 ms	R/W	Word
	13 hex	DecelTime	Deceleration time (ms)	0 to 65535 ms	R/W	Word
	14 hex	LowSpdLimit	Lower limit speed (r/min)	0 to 32767 r/min	R/W	Word
	15 hex	HighSpdLimit	Maximum speed (r/min)	0 to 32767 r/min	R/W *	Word
	16 hex	SpeedScale	Change the speed scale (r/min) all at once, as calculated below. $\frac{\text{r/min}}{2^{\text{SpeedScale}}}$	-15 to 15 (Factory default: 0)	R/W	Byte
	17 hex	CurrentScale	Change the current scale (0.1 A) all at once, as calculated below. $\frac{0.1 \text{ A}}{2^{\text{CurrentScale}}}$	-15 to 15 (Factory default: 0)	R/W	Byte
	1B hex	VoltageScale	Change the voltage scale (V) all at once, as calculated below. $\frac{\text{V}}{2^{\text{VoltageScale}}}$	-15 to 15 (Factory default: 0)	R/W	Byte
1C hex	TimeScale	Change the time scale (ms) all at once, as calculated below. $\frac{\text{ms}}{2^{\text{TimeScale}}}$	-15 to 15 (Factory default: 0)	R/W	Byte	
1D hex	RefFromNet	Current speed command source	00: Inverter 01: DeviceNet	R	Byte	

* "Read-only" while the inverter is running.

(5) Inverter Function Code object (Class 64 hex.)

This object configures or refers to inverter's function codes.



Instance corresponds to function code group and Attribute, to function code number.

Example: To configure F26 data, specify 04 hex for Instance and 1A hex (=26) for Attribute.



Inverter's function codes have individually specified data formats. For details about the data formats, refer to the RS-485 Communication User's Manual, Chapter 5 "Function Codes and Data Formats." For details about function code data, refer to the FRENIC-MEGA Instruction Manual, Chapter 5 "FUNCTION CODES."

Instance	Attribute	Name	Description	Value (hex.)	R/W	Data size
02 (S codes)	01	S01	Communication function code S01	0 to FFFF	R/W	Word
	⋮	⋮	⋮	⋮	⋮	⋮
	63 hex (99)	S99	Communication function code S99	0 to FFFF	R/W	Word
03 (M codes)	01	M01	Communication function code M01	0 to FFFF	R	Word
	⋮	⋮	⋮	⋮	⋮	⋮
	63 hex (99)	M99	Communication function code M99	0 to FFFF	R	Word
04 (F codes)	01	F01	Inverter function code F01	0 to FFFF	R/W	Word
	⋮	⋮	⋮	⋮	⋮	⋮
	63 hex (99)	F99	Inverter function code F99	0 to FFFF	R/W	Word
05 (E codes)	01	E01	Inverter function code E01	0 to FFFF	R/W	Word
	⋮	⋮	⋮	⋮	⋮	⋮
	63 hex (99)	E99	Inverter function code E99	0 to FFFF	R/W	Word
06 (C codes)	01	C01	Inverter function code C01	0 to FFFF	R/W	Word
	⋮	⋮	⋮	⋮	⋮	⋮
	63 hex (99)	C99	Inverter function code C99	0 to FFFF	R/W	Word
07 (P codes)	01	P01	Inverter function code P01	0 to FFFF	R/W	Word
	⋮	⋮	⋮	⋮	⋮	⋮
	63 hex (99)	P99	Inverter function code P99	0 to FFFF	R/W	Word
08 (H codes)	01	H01	Inverter function code H01	0 to FFFF	R/W	Word
	⋮	⋮	⋮	⋮	⋮	⋮
	63 hex (99)	H99	Inverter function code H99	0 to FFFF	R/W	Word
09 (A codes)	01	A01	Inverter function code A01	0 to FFFF	R/W	Word
	⋮	⋮	⋮	⋮	⋮	⋮
	63 hex (99)	A99	Inverter function code A99	0 to FFFF	R/W	Word
0A (10) (o codes)	01	o01	Option function code o01	0 to FFFF	R/W	Word
	⋮	⋮	⋮	⋮	⋮	⋮
	63 hex (99)	o99	Option function code o99	0 to FFFF	R/W	Word
0E (14) (J codes)	01	J01	Inverter function code J01	0 to FFFF	R/W	Word
	⋮	⋮	⋮	⋮	⋮	⋮
	63 hex (99)	J99	Inverter function code J99	0 to FFFF	R/W	Word

Instance	Attribute	Name	Description	Value (hex.)	R/W	Data size
0F (15) (y codes)	01	y01	Inverter function code y01	0 to FFFF	R/W	Word
	⋮	⋮	⋮	⋮	⋮	⋮
	63 hex (99)	y99	Inverter function code y99	0 to FFFF	R/W	Word
10 (16) (W codes)	01	W01	Communication function code W01	0 to FFFF	R	Word
	⋮	⋮	⋮	⋮	⋮	⋮
	63 hex (99)	W99	Communication function code W99	0 to FFFF	R	Word
11 (17) (X codes)	01	X01	Communication function code X01	0 to FFFF	R	Word
	⋮	⋮	⋮	⋮	⋮	⋮
	63 hex (99)	X99	Communication function code X99	0 to FFFF	R	Word
12 (18) (Z codes)	01	Z01	Communication function code Z01	0 to FFFF	R	Word
	⋮	⋮	⋮	⋮	⋮	⋮
	63 hex (99)	Z99	Communication function code Z99	0 to FFFF	R	Word
13 (19) (b codes)	01	b01	Inverter function code b01	0 to FFFF	R/W	Word
	⋮	⋮	⋮	⋮	⋮	⋮
	63 hex (99)	b99	Inverter function code b99	0 to FFFF	R/W	Word
0C (12) (r codes)	01	r01	Inverter function code r01	0 to FFFF	R/W	Word
	⋮	⋮	⋮	⋮	⋮	⋮
	63 hex (99)	r99	Inverter function code r99	0 to FFFF	R/W	Word
14 (20) (d codes)	01	d01	Inverter function code d01	0 to FFFF	R/W	Word
	⋮	⋮	⋮	⋮	⋮	⋮
	63 hex (99)	d99	Inverter function code d99	0 to FFFF	R/W	Word

8.3 Error Code List for Explicit Message Errors

If an explicit message sent from the master contains any error, the communications card responds to the master with "94" in the service code and "error code" (see Table 8.1) in the data.

An error code is two bytes long, consisting of a general code and additional code. Some error codes have no additional code and have "FF" instead.

Table 8.1 Error Code List for Explicit Message Errors

Error code		Error name	Description	Error recovery
General code	Additional code			
08	FF	Service not supported	Invalid service code	Correct service code. (Read: 0E hex, Write: 10 hex)
0E	FF	Invalid attribute value	Attempted to change a write-inhibited variable.	Check the specified variable again.
13	FF	Not enough data	Attempted to write Byte data to Word variable.	Match the data size.
14	FF	Attribute not supported	Access to a nonexistent variable.	Check the specified variable again.
15	FF	Too much data	Attempted to write Word data to Byte variable.	Match the data size.
16	FF	Object does not exist	Access to a nonexistent object.	Correct the contents of the Class.
1F	See blow.	Vender specific error	Error unique to vendor	See below.
	02	No function code (in writing)	Attempted to write to a nonexistent function code.	Correct the function code number specified.
	03	Function code not allowed to change	Attempted to write to a read-only function code.	Correct the function code number specified.
	06	Not allowed to change in running	Attempted to write to a function code not allowed to change when the inverter is running.	Write after the inverter is stopped.
	07	Not allowed to change with X terminal being ON	Attempted to write to a function code not allowed to change when X terminal is ON.	Write after the X terminal is turned OFF.
	08	Data entry range error	Attempted to write data out of the range.	Write data within the range.
	0F	Function code data being written	Requested to write to a function code being written.	Request to write after completion of the current writing operation.
	21	No function code (in reading)	Attempted to read from a nonexistent function code.	Correct the function code number specified.
20	FF	Invalid parameter	Attempted to write a value out of the range.	Correct the value within the range.

Chapter 9 INVERTER REACTION TO DeviceNet COMMUNICATIONS ERRORS

Inverter's function codes o27 and o28 specify the inverter reaction to be taken after an error occurrence. Table 9.1 lists the settings for o27 and o28. The same setting can also be made by the DeviceNet variable DNFaultMode (Class: 0x29, Instance: 0x01, Attribute: 0x10).

Table 9.2 lists the inverter reaction specified by the DNFaultMode. The setting value of o27 and that of DNFaultMode are interlocked with each other. Changing either one automatically changes the other one.

Table 9.1 Inverter Reactions to DeviceNet Communications Errors Specified by Function Codes o27 and o28

o27 data	o28 data	Inverter reaction to DeviceNet communications error	Remarks
0, 4 to 9	---	Immediately coast to a stop and trip with $\bar{E}r\bar{S}$.	
1	0.0 s to 60.0 s	After the time specified by o28, coast to a stop and trip with $\bar{E}r\bar{S}$.	
2	0.0 s to 60.0 s	If the communications link is restored within the time specified by o28, ignore the communications error. After the timeout, coast to a stop and trip with $\bar{E}r\bar{S}$.	
3, 13 to 15	---	Keep the current operation, ignoring the communications error. (No $\bar{E}r\bar{S}$ trip)	
10	---	Immediately decelerate to a stop. Issue $\bar{E}r\bar{S}$ after stopping.	The inverter's function code F08 specifies the deceleration time.
11	0.0 s to 60.0 s	After the time specified by o28, decelerate to a stop. Issue $\bar{E}r\bar{S}$ after stopping.	Same as above.
12	0.0 s to 60.0 s	If the communications link is restored within the time specified by o28, ignore the communications error. After the timeout, decelerate to a stop and trip with $\bar{E}r\bar{S}$.	Same as above.
13	---	Immediately run command OFF. (No $\bar{E}r\bar{S}$ trip)	
14	---	Force to rotate the motor in forward direction. (No $\bar{E}r\bar{S}$ trip)	Forward rotation is enabled when NetCtrl = 1.
15	---	Force to rotate the motor in reverse direction. (No $\bar{E}r\bar{S}$ trip)	Reverse rotation is enabled when NetCtrl = 1.

Table 9.2 Inverter Reactions to DeviceNet Communications Errors Specified by DNFaultMode

DNFaultMode	Inverter reaction to DeviceNet communications error	Remarks	o27 data
0	Immediately run command OFF. (No $\bar{E}r\bar{S}$ trip)		13
1	Ignore the communications error. (No $\bar{E}r\bar{S}$ trip)		3
2	If the communications link is restored within the time specified by o28, ignore the communications error. After the timeout, decelerate to a stop and trip with $\bar{E}r\bar{S}$.	The inverter's function code F08 specifies the deceleration time.	12
3	Force to rotate the motor in forward direction. (No $\bar{E}r\bar{S}$ trip)	Forward rotation is enabled when NetCtrl = 1.	14
4	Force to rotate the motor in reverse direction. (No $\bar{E}r\bar{S}$ trip)	Reverse rotation is enabled when NetCtrl = 1.	15
100	Immediately coast to a stop and trip with $\bar{E}r\bar{S}$.		0
101	After the time specified by o28, coast to a stop and trip with $\bar{E}r\bar{S}$.		1
102	If the communications link is restored within the time specified by o28, ignore the communications error. After the timeout, coast to a stop and trip with $\bar{E}r\bar{S}$.		2
110	Immediately decelerate to a stop. Issue $\bar{E}r\bar{S}$ after stopping.	The inverter's function code F08 specifies the deceleration time.	10
111	After the time specified by o28, decelerate to a stop. Issue $\bar{E}r\bar{S}$ after stopping.	Same as above.	11
112	Same as for [DNFaultMode = 2]		12

Chapter 10 ALARM CODE LIST

The information on alarms that have occurred in the inverter can be monitored through DeviceNet.

They are stored in the inverter's function codes M16 to M19 as listed in Table 10.1.

The communication-dedicated function codes M16 to M19 store information on the latest alarm code, last alarm code, 2nd last alarm code, and 3rd last alarm code, respectively.

Table 10.1 Alarm Codes

Alarm codes in M16 to M19	Description		Alarm codes in M16 to M19	Description	
0 (00 _H)	No alarm	---	29 (1D _H)	NTC thermistor wire break	<i>nr b</i>
1 (01 _H)	Overcurrent (during acceleration)	<i>OL 1</i>	31 (1F _H)	Memory error	<i>Er 1</i>
2 (02 _H)	Overcurrent (during deceleration)	<i>OL 2</i>	32 (20 _H)	Keypad communications error	<i>Er 2</i>
3 (03 _H)	Overcurrent (During running at constant speed)	<i>OL 3</i>	33 (21 _H)	CPU error	<i>Er 3</i>
5 (05 _H)	Grounding fault	<i>EF</i>	34 (22 _H)	Option communications error	<i>Er 4</i>
6 (06 _H)	Overvoltage (during acceleration)	<i>OU 1</i>	35 (23 _H)	Option error	<i>Er 5</i>
7 (07 _H)	Overvoltage (during deceleration)	<i>OU 2</i>	36 (24 _H)	Operation protection	<i>Er 6</i>
8 (08 _H)	Overvoltage (during running at constant speed or stopped)	<i>OU 3</i>	37 (25 _H)	Tuning error	<i>Er 7</i>
10 (0A _H)	Undervoltage	<i>LU</i>	38 (26 _H)	RS-485 communications error (COM port 1)	<i>Er 8</i>
11 (0B _H)	Input phase loss	<i>LI n</i>	44 (2C _H)	Overload of motor 3	<i>OL 3</i>
14 (0E _H)	Fuse blown	<i>FUS</i>	45 (2D _H)	Overload of motor 4	<i>OL 4</i>
16 (10 _H)	Charger circuit fault	<i>PCF</i>	46 (2E _H)	Output phase loss	<i>OPL</i>
17 (11 _H)	Heat sink overheat	<i>OH 1</i>	47 (2F _H)	Speed mismatch (Excessive speed deviation)	<i>Er E</i>
18 (12 _H)	External alarm	<i>OH 2</i>	51 (33 _H)	Data saving error during undervoltage	<i>Er F</i>
19 (13 _H)	Inverter internal overheat	<i>OH 3</i>	53 (35 _H)	RS-485 communications error (COM port 2)	<i>Er P</i>
20 (14 _H)	Motor protection (PTC/NTC thermistor)	<i>OH 4</i>	54 (36 _H)	Hardware error	<i>Er H</i>
22 (16 _H)	Braking resistor overheat	<i>dbH</i>	56 (38 _H)	Positioning control error	<i>Er o</i>
23 (17 _H)	Overload of motor 1	<i>OL 1</i>	57 (39 _H)	EN circuit failure	<i>ECF</i>
24 (18 _H)	Overload of motor 2	<i>OL 2</i>	58 (3A _H)	PID feedback wire break	<i>CoF</i>
25 (19 _H)	Inverter overload	<i>OLU</i>	59 (3B _H)	Braking transistor broken	<i>dbA</i>
27 (1B _H)	Overspeed	<i>OS</i>	254 (FE _H)	Mock alarm	<i>Er r</i>
28 (1C _H)	PG wire break	<i>PG</i>			

Chapter 11 TROUBLESHOOTING

If any problem or error occurs during DeviceNet communication, follow the troubleshooting procedures given below.

No	Phenomenon/Symptom	Probable Causes
1	None of the LEDs on the communications card would light.	<ul style="list-style-type: none"> • The communications card is not properly mounted. • The communications card is faulty.
2	E_r-4 alarm cannot be reset (The MS LED lights in red).	<ul style="list-style-type: none"> • The communications card is not properly mounted. • The communications card is faulty. • Other type of communications card is mounted.
3	The NS LED lights in red. (E_r-5 alarm cannot be reset.)	<ul style="list-style-type: none"> • The same node address is double assigned in DeviceNet. • There is a mismatch in baud (data) rate. • The network power (24 V) is not properly supplied. • Cabling for DeviceNet communications is not properly done. • The inverter has not restarted after modification of the DIP switch configuration.
4	The NS LED blinks in red. (E_r-5 alarm has occurred.)	<ul style="list-style-type: none"> • The cable was broken during communication. • The I/O scan interval is too short.
5	The NS LED would not light.	<ul style="list-style-type: none"> • The node address for the communications card is improper. • The cable for DeviceNet communications was broken.
6	The NS LED keeps blinking in green and does not come to stay on in green.	<ul style="list-style-type: none"> • The master does not request a connection. • The I/O scan interval has been set to be too short at the start of communication. • The I/O area is invalidly mapped. • There is no I/O connection.
7	Even though the NS LED lights in green, the settings for run command or speed command cannot be validated.	<ul style="list-style-type: none"> • Neither NetCtrl nor NetRef is set to "1." • On the inverter, the higher-priority run command or speed command is enabled. • There is a mistake in the selection of I/O Assembly Instances. • The inverter has not restarted after modification of any of the o31 and o40 to o43 data.
8	Although the speed command has been validated, the actual speed is different from it.	<ul style="list-style-type: none"> • Refer to the FRENIC-MEGA Instruction Manual, Chapter 6, Section 6.3.1 "Motor is running abnormally."

Chapter 12 SPECIFICATIONS

12.1 General Specifications

Install the inverter equipped with the communications card in an environment that satisfies the requirements listed below.

Item	Specifications
Site location	Indoors
Surrounding temperature	Refer to the FRENIC-MEGA Instruction Manual, Chapter 2.
Relative humidity	5 to 95% (No condensation)
Atmosphere	The inverter must not be exposed to dust, direct sunlight, corrosive gases, flammable gases, oil mist, vapor or water drops. Pollution degree 2 (IEC60664-1) (Note) The atmosphere can contain a small amount of salt. (0.01 mg/cm ² or less per year) The inverter must not be subjected to sudden changes in temperature that will cause condensation to form.
Altitude	1,000 m max.
Atmospheric pressure	86 to 106 kPa
Vibration	Refer to the FRENIC-MEGA Instruction Manual, Chapter 2.

(Note) Do not install the inverter in an environment where it may be exposed to lint, cotton waste or moist dust or dirt which will clog the heat sink of the inverter. If the inverter is to be used in such an environment, install it in a dustproof panel of your system.

12.2 DeviceNet Specifications

Item	Specifications			
Network input voltage	11 to 25 V			
Network power consumption	75 mA at maximum (24 VDC) (Note) The network power is supplied by an external power source.			
No. of nodes connected	64 at maximum (including the master)			
MAC ID	0 to 63			
Insulation	500 VDC (photocoupler insulation)			
Transmission rate	500 kbps/250 kbps/125 kbps			
Maximum cable length (Trunk line: thick cable Drop line: thin cable)	Transmission rate	500 kbps	250 kbps	125 kbps
	Trunk line length	100 m	250 m	500 m
	Drop line length	6 m	6 m	6 m
	Total length of drop lines	39 m	78 m	156 m
Messages supported	1. I/O Message (Poll, Change of State) 2. Explicit Message			
Vendor ID	319 (Fuji Electric Group)			
Device type	AC drive (code: 2)			
Product code	9219			
Model name	OPC-G1-DEV			
Applicable device profile	AC Drive			
No. of input/output bytes	Selectable between 4 and 8 bytes for input and output (independently)			
Applicable DeviceNet Specifications	CIP Specifications Volume 1, Edition 2.2 Japanese version and Volume 3, Edition 1.1 Japanese version (Certified by ODVA Japan for Conformance Test Version 20)			
Node type	Group 2 only server			

MEMO

**DeviceNet 通信カード / DeviceNet Communications Card
"OPC-G1-DEV"**

取扱説明書 / Instruction Manual

First Edition, June 2008

Third Edition, April 2011

Fuji Electric Co., Ltd.

- この取扱説明書の一部または全部を無断で複製・転載することはお断りします。
- この説明書の内容は将来予告なしに変更することがあります。
- 本書の内容については、万全を期して作成いたしました。が、万一ご不審の点や誤り、記載もれなど、お気づきの点がありましたら、ご連絡ください。
- 運用した結果の影響については、上項にかかわらず責任を負いかねますのでご了承ください。

The purpose of this manual is to provide accurate information in the handling, setting up and operating of the DeviceNet communications card for the FRENIC-MEGA series of inverters. Please feel free to send your comments regarding any errors or omissions you may have found, or any suggestions you may have for generally improving the manual.

In no event will Fuji Electric Co., Ltd. be liable for any direct or indirect damages resulting from the application of the information in this manual.

富士電機株式会社

パワーレ機器事業本部 ドライブ事業部
〒141-0032 東京都品川区大崎一丁目11番2号
(ゲートシティ大崎イーストタワー)

URL <http://www.fujielectric.co.jp/>

発行 富士電機株式会社 鈴鹿工場

〒513-8633 三重県鈴鹿市南玉垣町5520番地

技術相談窓口 TEL:0120-128-220 FAX:0120-128-230

Fuji Electric Co., Ltd.

Gate City Ohsaki, East Tower, 11-2, Osaki 1-chome,
Shinagawa-ku, Tokyo, 141-0032, Japan

Phone: +81 3 5435 7283 Fax: +81 3 5435 7425

URL <http://www.fujielectric.com/>