

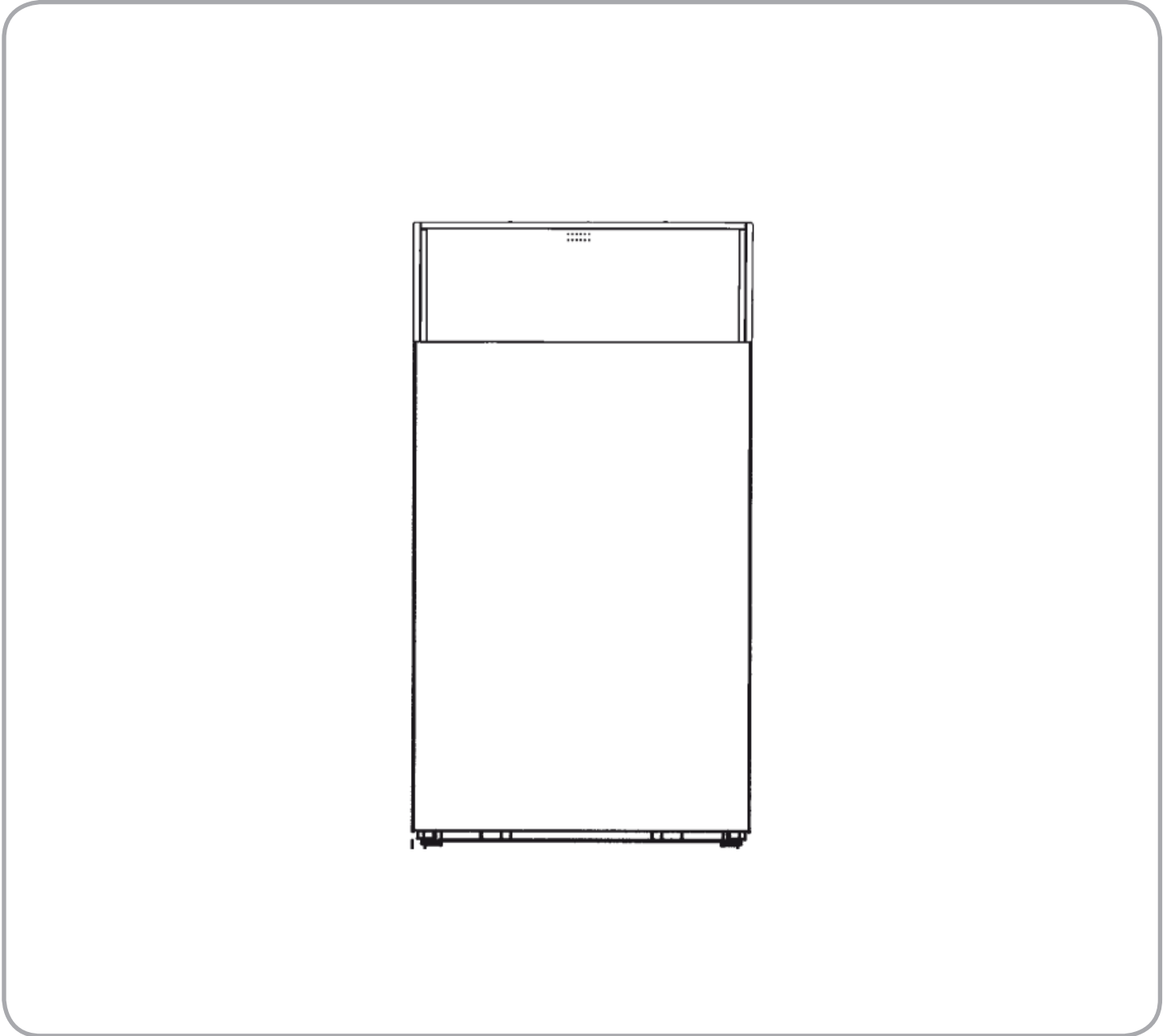

**NOVELLA
BOILERS**

**CAST IRON
BASE**



Novella boilers conform to the basic requirements of the following directives:

- Gas Appliances Directive 2009/142/CE
- Boiler Efficiency Directive 92/42/CEE (★★)
- Electromagnetic Compatibility Directive 2004/108/CE
- Low Voltage Directive 2006/95/CE

boilers are therefore CE marked.



The following symbols are used in this manual:

 **CAUTION!** = Indicates actions that require caution and adequate preparation

 **STOP!** = Identifies actions that you **MUST NOT** do

CONTENTS

1 GENERAL SAFETY INFORMATION	5
2 SAFETY PRECAUTIONS.....	6
3 DESCRIPTION OF THE APPLIANCE.....	7
4 LIGHTING THE BOILER	8
5 SHUTTING DOWN THE BOILER	9
6 MAINTENANCE.....	10
7 OPTIONAL ACCESSORIES.....	11

Dear Customer,

Beretta has always viewed customer satisfaction as its top priority, and applies all its experience and know-how to the creation of its products.

This easy-to-consult manual has been specially written to familiarise you with your new boiler and to help you fully appreciate the benefits of independent central heating and instant hot water production.

Please read this manual thoroughly. It contains important instructions and recommendations for the correct operation and servicing of your new boiler.

Please keep this manual safe for future reference once you have read it.

For any other information or requirement, please contact the

“BERETTA CUSTOMER SERVICE”

By calling **199 13 31 31**, you can speak to a qualified operator who will be happy to provide any additional information you need on the functioning of your boiler. You can also find out more about the Beretta range of products and services, and pass on any suggestions or comments you might have.

If an operator is not available when you call, please leave a message and we shall return your call as soon as possible.

Remember too that Beretta's operates a Technical Assistance Service staffed by qualified personnel who are always ready to respond to your calls.

To contact your local











“TECHNICAL ASSISTANCE CENTRE”

call the universal number **199 12 12 12**. Your call will be transferred to the Technical Assistance Centre nearest to you.

 **Beretta**

1 GENERAL SAFETY INFORMATION

This operation manual forms an integral part of your new boiler. As such, it must be kept safe and must always accompany the boiler. If it becomes damaged or lost, request a copy from the manufacturer's Technical Assistance Service.

-  Your new boiler must only be installed and serviced by qualified personnel, in conformity to applicable legislation and applicable technical standards.
-  Make sure that your new boiler is installed by a qualified heating engineer.
-  The boiler must only be used for the purpose for which it is designed and made. The manufacturer declines all responsibility, contractual or other, for damage to property or injury to persons or animals caused by improper installation, adjustment, maintenance or use.
-  Do not tamper with the boiler's automatic safety or control devices at any time during its working life. The servicing of such devices must be referred to the manufacturer or supplier.
-  The boiler is designed to generate hot water and must be connected to a central heating system and/or to a domestic hot water distribution system compatible with its performance and heat output.
-  If water leaks from the boiler, turn off the water supply and contact the manufacturer's Technical Assistance Service immediately.
-  If the boiler is not going to be used for an extended period of time, close the gas shut-off cock and switch the boiler off at the mains power switch. Empty the boiler's water circuit if there is any risk of freezing.
-  Periodically check that operating pressure in the water circuit is over 1 bar.
-  In the event of a fault or malfunction, shut down the boiler and switch it off at the mains. Do not attempt to repair or service it yourself.
-  The boiler must be serviced at least once a year. You can save both time and money by arranging servicing in advance with the manufacturer's Technical Assistance Service.

2 SAFETY PRECAUTIONS

Always observe the following fundamental safety precautions when operating your **Novella** boiler.

 Do not use the boiler for any purpose for which it was not designed.

 Do not touch the boiler when barefoot or wet. Risk of electric shock!

 Do not operate any electrical switches, telephones or any other equipment that might cause a spark if you smell gas. Thoroughly ventilate the room by opening wide all doors and windows, and close the gas shut-off valve.

 Do not place objects on the boiler.

 Always switch the boiler off at the mains switch before commencing any cleaning operations.

 Do not store containers of flammable substances in the room where the boiler is installed.

 In the event of a fault or malfunction, do not attempt to repair or service the boiler yourself.

 Do not pull on or twist the boiler's electrical cables.

 Do not allow children or uninformed persons to operate the boiler.

 Do not block the air vents in the room in which the boiler is installed with rags or paper etc.

 Do not obstruct or restrict the air vents in the room where the boiler is installed.

To get the best from your boiler, always remember the following hints.

- Periodic cleaning of the boiler's casing with soapy water not only keeps your boiler looking attractive but also protects the casing against rust and extends its working life.
- Installation of the optional accessories listed on page 16 increases the level of comfort in your home, ensures more rational use of your boiler and helps save energy.

3 DESCRIPTION OF THE APPLIANCE

Novella boilers are floor standing, gas fuelled boilers with an atmospheric burner and cast iron heat exchanger. They are specially designed for use in central heating systems, but can also generate domestic hot water if connected to a suitable storage cylinder.

Novella boilers feature electronic ignition and ionisation flame detection.

The control panel (fig. 3.1) houses all the controls needed to control the various functions of the boiler.

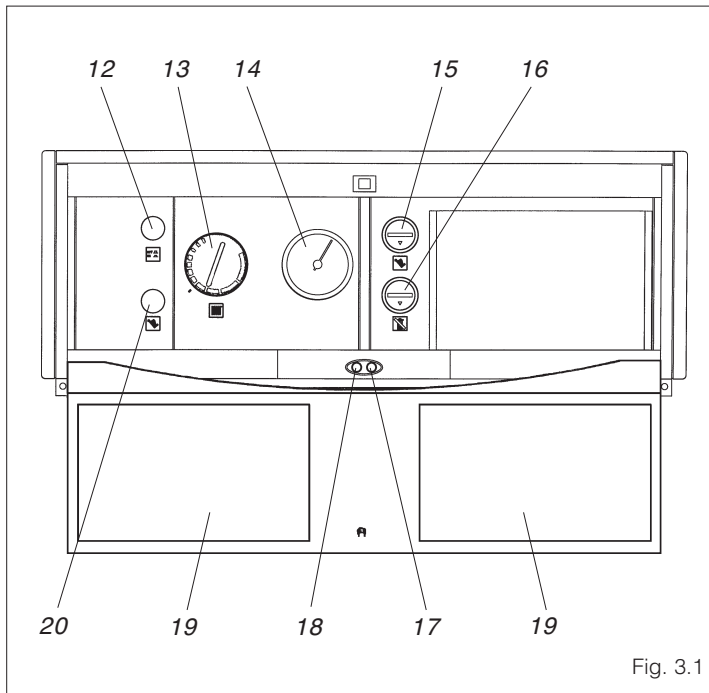

Key

- 12 ON/OFF switch
- 13 Central heating temperature control
- 14 Water circuit temperature gauge
- 15 Safety thermostat (manual reset)
- 16 Flue gas thermostat (manual reset)
- 17 Red "burner lockout" LED warning light
- 18 Green "power on" LED indicator
- 19 Quick reference guide
- 20 Burner reset button

Fig. 3.1

4 STARTING UP THE BOILER

Your new boiler must be started up for the first time by the manufacturer's Technical Assistance Service.

Subsequently, proceed as follows to start up the boiler whenever necessary.

Once you have completed all the preparatory steps, proceed as follows to start up the boiler for the first time.

- Turn the boiler's mains power switch ON (fig. 4.1)

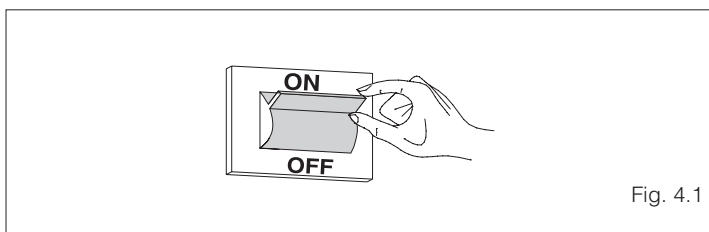

Fig. 4.1

- Set the room thermostat to the required temperature (~ 20°C) or, if the system has a timer or timer-thermostat, make sure that this is switched "On" and adjusted to the required temperature (~ 20°C) (fig. 4.2)

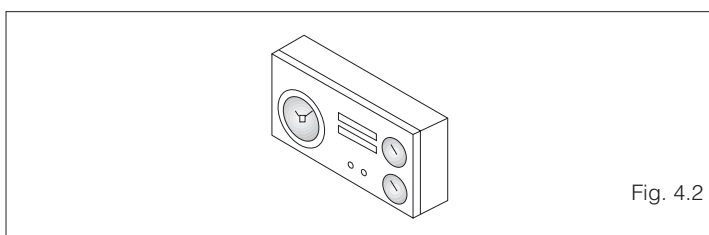

Fig. 4.2

- Adjust the boiler's temperature control to the desired temperature (operation not necessary if the boiler has been equipped with a temperature controller) (fig. 4.3)

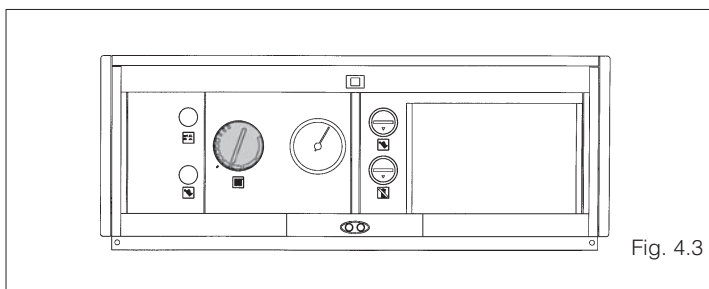

Fig. 4.3

- Switch the boiler on at the control panel switch and check that the green power indicator lights (fig. 4.4).

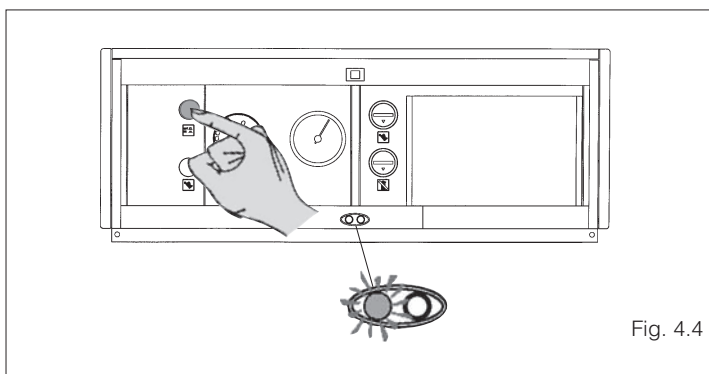

Fig. 4.4

The boiler will now start up and the burner will remain lit until the set temperature is reached.

If any ignition or functioning errors occur, the boiler enters "LOCK-OUT" and the red LED on the control panel comes on to indicate this (fig. 4.5).

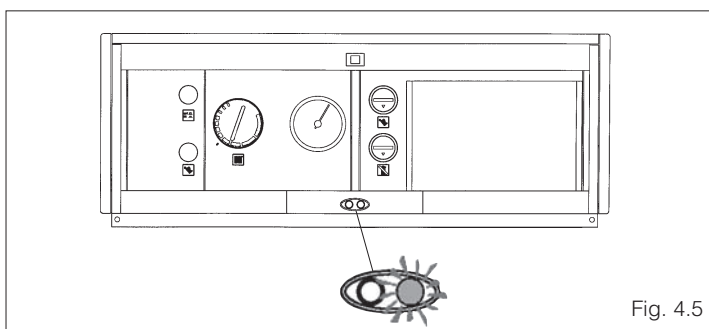

Fig. 4.5

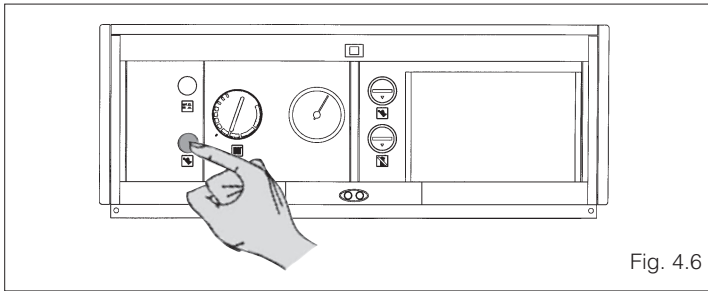

Fig. 4.6

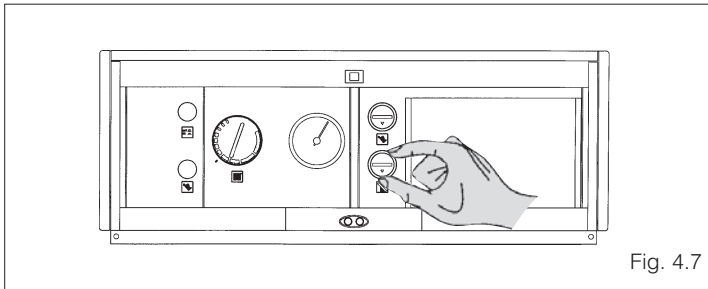

Fig. 4.7

Proceed as follows to reset the safety thermostat.

- Wait for about 1 minute, then press the "burner reset" button (fig. 4.6).
- Wait for the burner to complete the entire start-up cycle again, up to the ignition of the flame.

The boiler will also shut down if the flue gas thermostat trips. To reset the boiler in this case, remove the hood and reset the flue gas thermostat (fig. 4.7).

! If the flue gas thermostat trips repeatedly, make sure that the flue gas pipes are not blocked and that the flue is properly constructed.

! Novella boilers are equipped with a factory-calibrated minimum pressure switch for the gas supply. This shuts down the boiler if the gas supply pressure is not sufficient to ensure correct functioning. Operation of this pressure switch is not signalled.

5 SHUT-DOWN

If the boiler is not going to be used for an extended period of time, perform the following operations.

- Switch the boiler on at the control panel switch and check that the green power indicator lights (fig. 5.1).

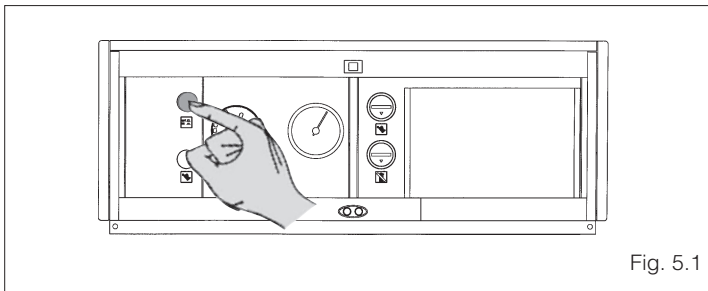

Fig. 5.1

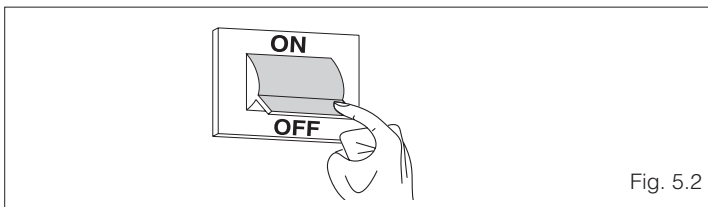

Fig. 5.2

- Turn the mains power switch OFF (fig. 5.2).

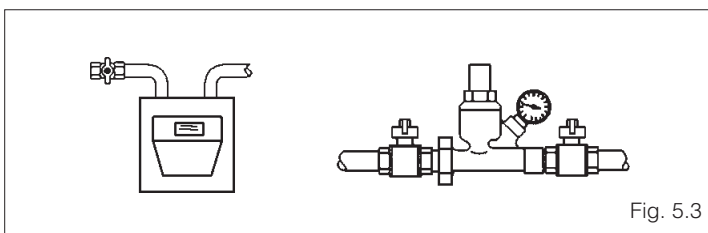

Fig. 5.3

- Close the boiler's fuel cock and water circuit cock (fig. 5.3).

! Empty the boiler if there is any risk of freezing

6 MAINTENANCE

The only maintenance that the user can perform is the cleaning of the outside of the boiler casing with a cloth damped in soapy water. To remove stubborn marks, use a cloth damped in a 50% mix of water and denatured alcohol or a suitable cleaning product. Do not use abrasive cleaning pads or powder detergents. Never clean the boiler without first disconnecting it from the mains electricity supply by turning the mains power switch and the control panel switch OFF.

Remember that safety legislation (in Italy, Presidential Decree 412 of the 26th August 1993) obliges the person responsible for the boiler to ensure that professionally qualified personnel perform periodic maintenance. The manufacturer's Technical Assistance Service is qualified to satisfy all legal requirements and can also offer scheduled maintenance contracts. Stipulation of a maintenance contract guarantees:

- greater savings
- greater safety
- greater comfort and peace of mind.

On request, the manufacturer's Technical Assistance Service will also provide you with a system service book. The Technical Assistance Service will also be pleased to instruct you how to get the best from your new boiler.

MAINTENANCE	FIRST YEAR	SECOND YEAR
CHECK ALL SEALING COMPONENTS.	•	•
CLEAN THE PRIMARY HEAT EXCHANGER ON THE FLUE GAS SIDE.	•	•
CLEAN THE COMBUSTION CHAMBER, FAN AND VENTURI.	•	•
CHECK THE WATER AND GAS SAFETY DEVICES.	•	•
CHECK THE GAS FLOW RATE AND ADJUST IF NECESSARY.	•	•
CHECK THE DRAUGHT OF THE FLUE.	•	•
CLEAN THE BURNER AND CHECK THAT IT LIGHTS PROPERLY.	•	•
CHECK THE FUNCTIONING OF THE WATER CIRCUIT.	•	•
ANALYSE COMBUSTION GASES.	-	•
CHECK AND LUBRICATE THE WATER CIRCUIT VALVE GROUP.	-	•
CHECK THE TIGHTNESS OF THE GAS CIRCUIT.	-	•
CLEAN THE HEAT EXCHANGER.	-	•
CHECK THE EFFICIENCY OF ALL ELECTRICAL AND ELECTRONIC DEVICES.	-	•
CHECK THE EFFICIENCY OF THE FAN.	•	•

7 OPTIONAL ACCESSORIES



Fig. 7.1

Wall-mounted weekly timer thermostat (fig. 7.1) (part number 1100279).

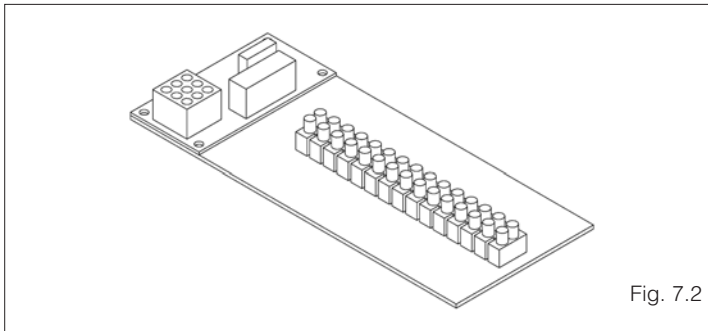

Fig. 7.2

Pump or valve controlled multizone central heating kit with total shut-down function (fig. 7.2) (part number 696439).

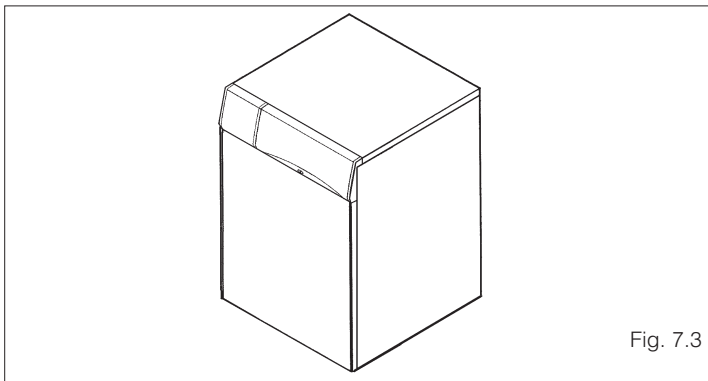

Fig. 7.3

RO120 storage cylinder (fig. 7.3) (part number 696339).

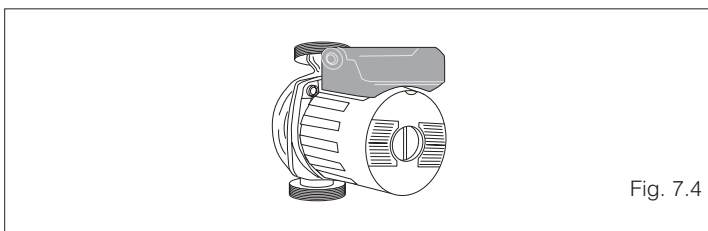

Fig. 7.4

High head pump (fig. 7.4) (part number 1100269).



Via Risorgimento, 13 - 23900 Lecco (LC)

Servizio Clienti 199.13.31.31*

Assistenza Tecnica Numero Unico 199.12.12.12*

www.berettaclima.it

Beretta is constantly improving its products and therefore reserves the right to modify the characteristics and specifications of the appliance described in this manual at any time and without prior notice.
The contents of this manual are not contractually binding on the manufacturer.