



Visit us at : <http://www.lgservice.com>

LG

LG Power Distribution Indicator

OWNER'S & INSTALLATION MANUAL

Models: PQNUD1S00

IMPORTANT

- Please read this user's manual completely before installing the product.
- Installation work must be performed in accordance with the national wiring standards by authorized personnel only.
- Please retain this user's manual for future reference after reading it thoroughly.

TABLE OF CONTENTS

Cautions for safety	3
Overview	6
Available Watt-hour meter	7
Wiring Diagram	10
Installation	11
How to set interface unit	17
How to set each Indoor Unit for Multi V	18
Installation Guide	20
Usage	21



FOR YOUR RECORDS

Write the model and serial numbers here:

Model # _____

Serial # _____

You can find them on a label on the side of each unit.

Dealer's Name _____

Date Purchased _____

■ Staple your receipt to this page in the event you need to prove date of purchase or to issue warranty.



READ THIS MANUAL

Inside you will find many helpful hints on how to use and maintain your Power Distribution Indicator properly. Just a little preventive care on your part can save you a great deal of time and money over the life of your Power Distribution Indicator.

You'll find many answers to common problems in the chart of troubleshooting tips. If you review our chart of

Troubleshooting Tips first, you may not need to call for service at all.

Cautions for safety

To prevent injury to the user or other people and property damage, the following instructions must be followed.

- Incorrect operation due to ignoring instruction will cause harm or damage. The seriousness is classified by the following indications.

WARNING

This symbol indicates the possibility of death or serious injury.

CAUTION

This symbol indicates the possibility of injury or damage to properties only.

- Meanings of symbols used in this manual are as shown below.



Be sure not to do.



Be sure to follow the instruction.

WARNING

■ WHEN INSTALLING

You should always request product installation to our Service Center or to installation expert agency.

- Otherwise it may cause fire hazard, electric shock, explosion, injury or damage.



Use specified parts.

- Or else it may cause fire hazard, electric shock, explosion, injury, damage and trouble failure.

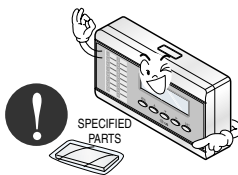

When reinstalling an existing installed product, request it to our Service Center or to installation expert agency.

- Otherwise it may cause fire hazard, electric shock, explosion, injury or damage.



Don't keep or use ignitable gas or any other flammable material in vicinity of the product.

- Otherwise it may cause fire hazard and product trouble failure.



Don't disassemble, repair and modify the product at your will.

- Or else it may cause fire hazard and electric shock.



Don't install it where rain falls on.

- Otherwise it may cause product failure.

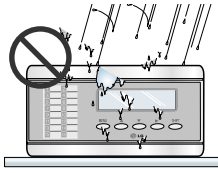

Don't install it in humid place.

- Otherwise it may cause product failure.

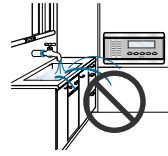

■ WHEN USING

Don't change or extend electric supply wire at your will.

- Or else it may cause fire hazard and electric shock.



Don't let there exist fire heat near the product.

- Otherwise it may cause fire hazard.

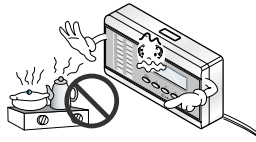

Don't use heat equipment near the electricity supply line.

- Or else it may cause fire hazard and electric shock.

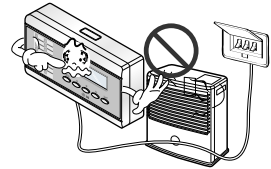

Don't spill water into interior of the product.

- Otherwise it may cause electric shock and product failure.



Don't put heavy material upon electricity supply chord.

- Or else it may cause fire hazard and electric shock.

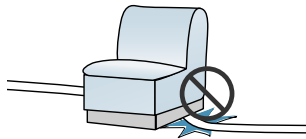

Don't put heavy material upon the product.

- Or else it may cause product trouble failure.



Always request to our Service Center or installation expert agency in such case as the product has been submerged under water.

- Or else it may cause fire hazard and electric shock.



Child or the old and the weak shall use it under custody of patron.

- Otherwise it may cause safety accident or product failure.

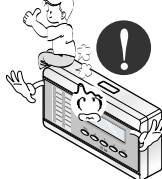

Don't give impact to the product.

- If the product is impacted, it may cause product trouble failure.

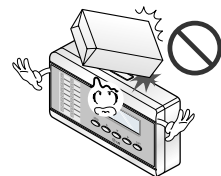

⚠ CAUTION

■ WHEN USING

Don't clean the product with strong detergent or solvents but only use soft cloth.

- Or else it may cause fire hazard and product deformation.



If water has been smeared on electric charge part, use it after removing water.

- Or else it may cause product failure.

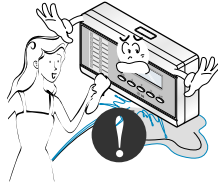

Don't let metallic products of necklace, coin, key, watch etc. touch the battery terminal.

- Or else it may cause product failure and injury.

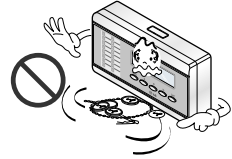

Overview

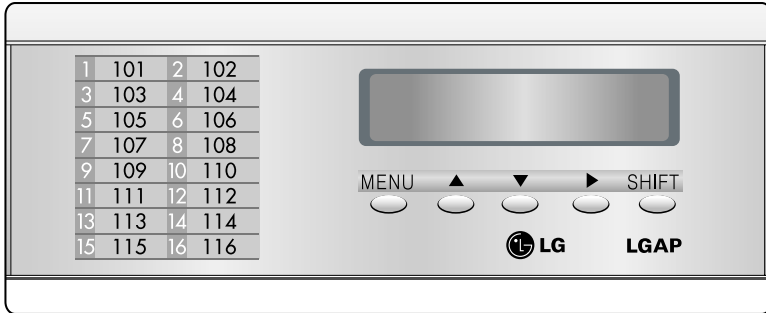

■ Functions

- Accumulation of total power consumption
- Indication of current power in use
- Indication of accumulated power for period
- Indication of standby power (option setting)

■ Specification

- Power Supply: 220~240V AC 50/60HZ 1Ø
- Dimension: 200mm (W) X 120mm (H) X 55mm (D)
- Connectable Units: 1 Outdoor Unit per Electric Power Distribution Indicator.

■ Count Method for Electric Power Distribution

- Power Consumption of each Indoor Unit = Power Consumption of Outdoor Unit x [Weighting Power of each Indoor Unit / Weighting Power of total Indoor Units]
- Weighting Power of each Indoor Unit = Operation (On/Off) x [Capacity of Indoor Unit X LEV open rate X Fan step of Indoor Unit]

■ Parts of a PDI

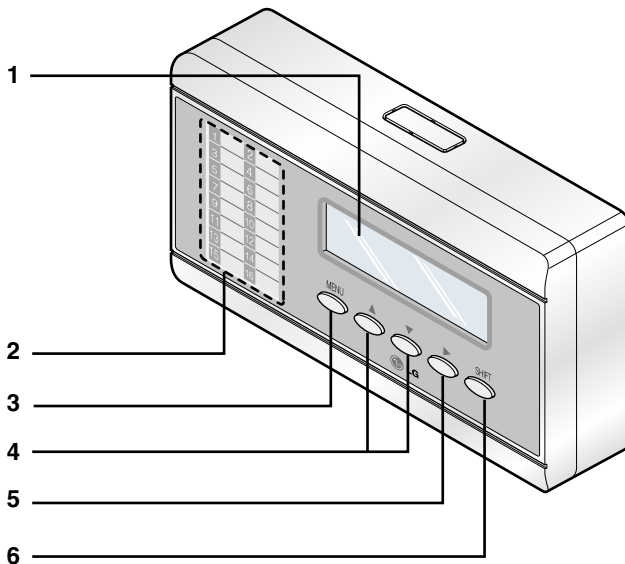

1. Indicator LCD Display
2. Name Plate of each room
3. Menu Button
4. Up and Down Button
5. Right Shift Button
6. SHIFT Button for LCD Screen Change

Available Watt-hour meter(Local purchase)

- Use the digital watt meter which send the pulse signal depending on the power consumption.
- Use watt meter of 1W/pulse, 2W/pulse, 4W/pulse, 6W/pulse, 8W/pulse or 10W/pulse (pulse width: 40 –400 msec).

Wiring Diagram

■ Independent operation of PDI

- Connect the product as shown in the below connection diagram

1. MultiV / MultiV PLUS(16 indoor units MAX.)

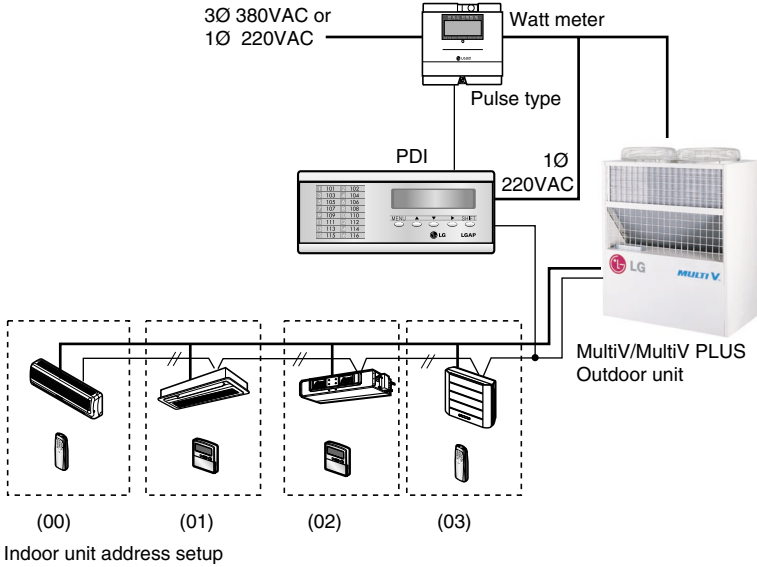

2. MPS multi Product / MultiV PLUS (48 indoor units MAX.)

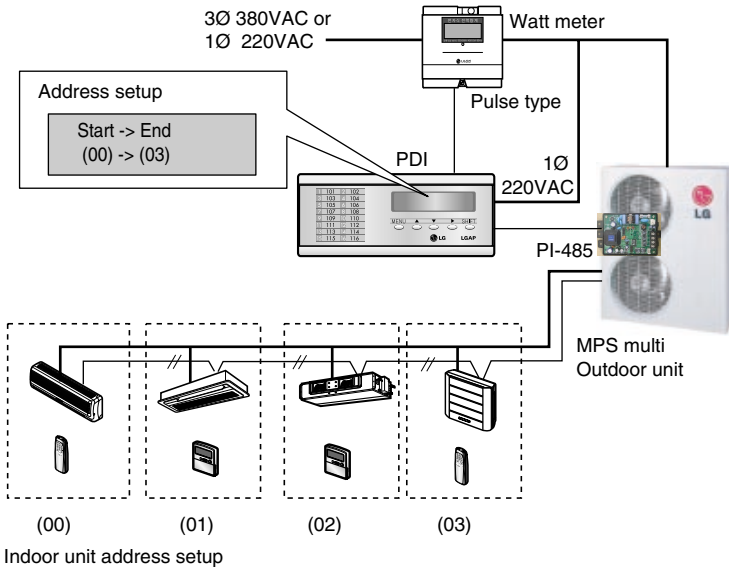

* NOTE : In connecting MPS product
PI-485 must be connected for PDI. (PI-485 must be purchased separately.)

■ Operation with PC Central controller

- Connect the product as shown in the below connection diagram.

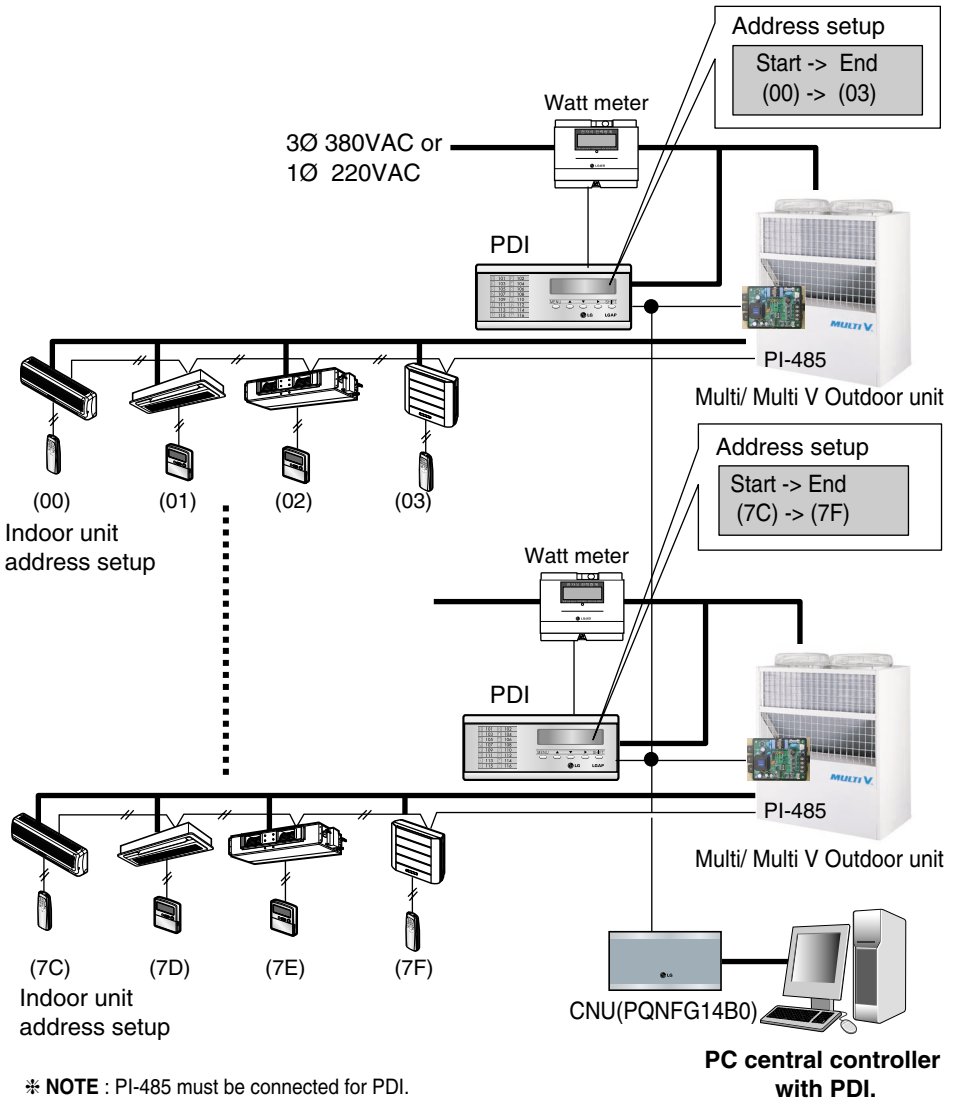

⚠ CAUTION

When CNU power off or out of order with PC central controller, the PDI can not distribute the power consumption.

Internal Wiring Diagram

■ Install the product as per the following wiring diagram

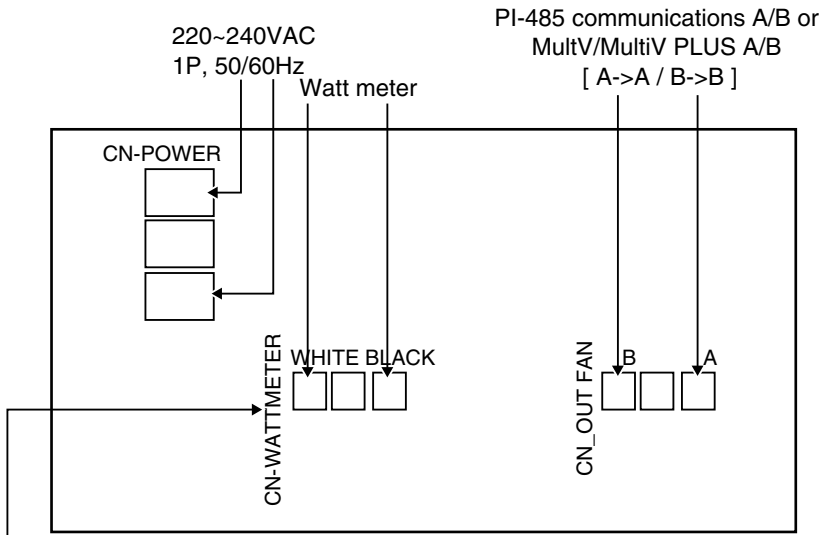
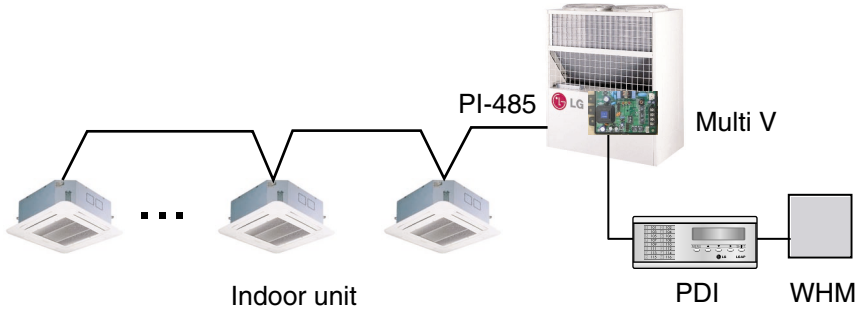

The color and polarity of the communications line can differ from what's indicated on the PCB depending on the manufacturer of watt meter. [Black -> (+), white -> (-)]

- Turn on the power after connecting the product.

Installation

How to set Option

1. You must start the key operation within 10 minutes after turning on the power for setting options.
2. When you press the Menu and Shift key at the same time, the following option screen will be shown.

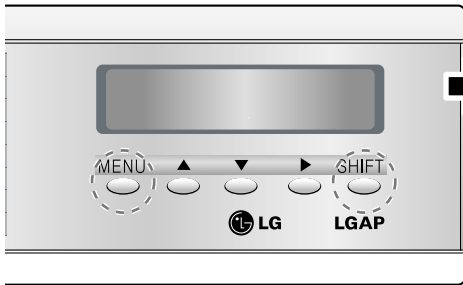

Initial Screen

ELECTRIC POWER
DISTRIBUTOR



Press Menu and Shift
at same time

Option setup screen

00000000	Unit 1W/p
MICRONIC	NO- STBP

• Product selection

When the first two digits flash, you can use the ▲ or ▼ key to set the product.

[00] -> Unit (When using in connection with Independent operation of PDI and MultiV / MultiV PLUS)

[10] -> Slave (when using in connection with PC central controller)

[11] -> Master (when not using in connection with PC central controller)

Ex) Product selection: Master, Watt meter: 1W/1 pulse

[11] : Independent operation of PDI

11:000000	Master1W/p
MICRONIC	NO- STBP

- After setting the product, press ► to select the next option.

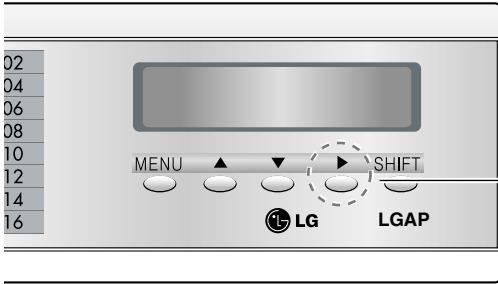

Press the ► key to set up the Option for remote reading service company selection.

• Remote reading service company selection

(Don't care selecting remote reading service ID.)

- When two digits flash, use the ▲ or ▼ key to select the remote reading service company.

[00] -> MICRONICS / [01] -> LSIS-COM
[10] -> CI-TOPIA / [11] -> OMNI-SYS

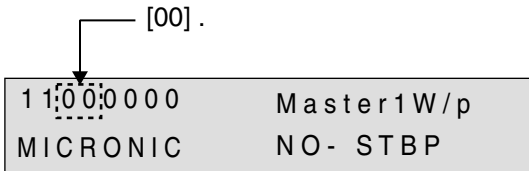

* This setting does not care to use PDI

- After setting the product, press ► to select the next option.

- After setting the product, press ► to select the next option.

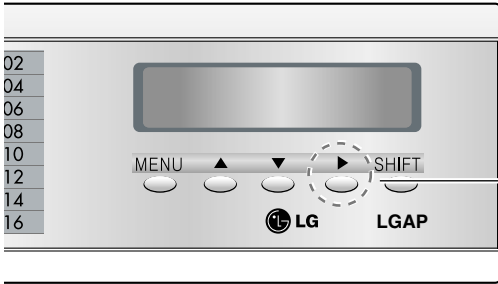

Press the ► key to set up the option for watt meter selection.

• Watt meter selection

- When the third 3 digits flash, use the ▲ or ▼ key to select the meter constant of the watt meter.

- [000] -> 1 W/ P / [001] -> 2 W/ P
- [010] -> 4 W/ P / [011] -> 6 W/ P
- [100] -> 8 W/ P / [101] -> 10 W/ P

Ex) Product selection: Master, watt meter: 2W/ pulse

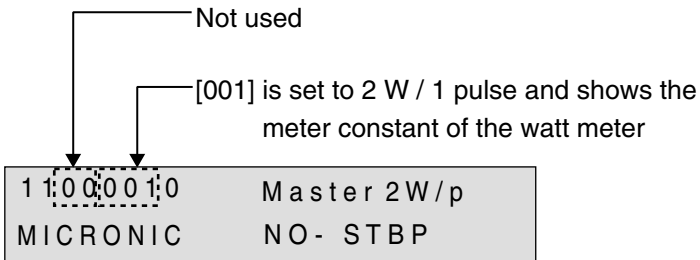

- After setting the product, press ► to select the next option.

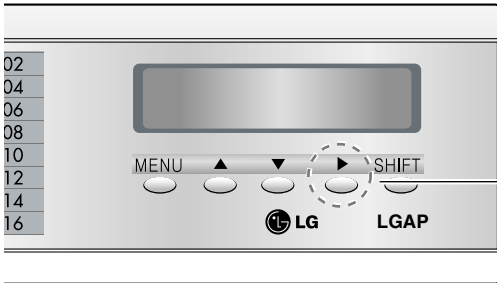

Press the ► key to select the option for standby power.

• Standby power indication selection

- When the forth digit flashes, use the ▲ or ▼ key to select the standby power.

[0] NO-STBP -> Does not show the standby power

[1] CAL-STEP -> Shows the standby power

• **Note** : If the PDI has been set Slave in previous option selection then Certainly Set NO-STBP

Ex) Product selection: Master, standby power indication selection

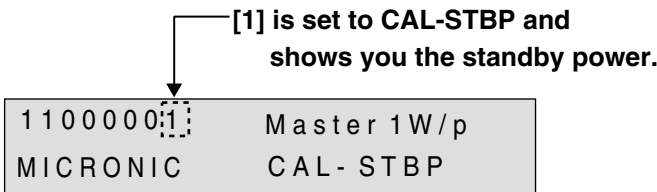

* What is standby power selection function?

: Standby power refers to the electric power consumed by the product after the operation of the product is turned off.

It is the function of separately saving the power consumed when all heating and air conditioning indoor units are turned off.

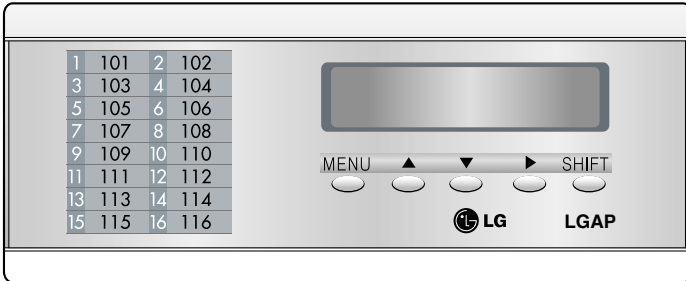

3. After setting the option, press the Shift key to enter the remote reading service ID setup mode.

(In case of selecting reading service ID in)

- This function is applicable to only korean marcket (Domestic)
So, skip this setting in the procedure for overseas market
Press the "SHIFT" key
- When the first two digits flash, use the s or t key to select the remote reading service ID by company.

CI-TOPIA ID setup

OUT DR ID(CITOPIA)
XX

MICRONICS ID setup

OUT DR ID(MICRONIC)
XX

OMNI SYS ID setup

OUT DR ID(OMNI-SYS)
XXXX

LS IS ID setup

OUT DR ID(LSIS)
XXXX

* When setting the remote reading service ID, enter the remote reading service ID assigned by the remote reading service company.

4. After entering the remote reading service ID, press the Shift key to enter the indoor address selection mode.

(In case of the selecting "Master/Slave")

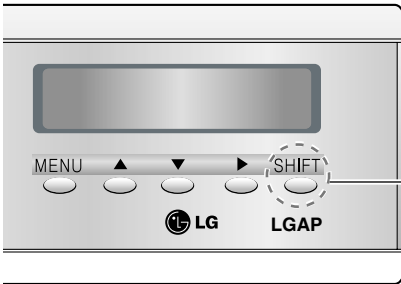

Press the Shift key to enter the indoor selection mode

Initial Screen

(S t a r t)	- >	(E n d)
(0 0)	- >	(0 0)

- You can select the option for indoor address selection mode only when Master / Slave is selected.
- You can distribute the using power to maximum of 48 indoor units. (When showing the stand by power, maximum of 47 indoor units.)

Ex 1) Distribution of using power to 64 indoor units
(central control address 00-2F)

(S t a r t)	- >	(E n d)
(0 0)	- >	(2 F)

* **NOTE 2)** : When operating in connection to the PC central controller, the range of the indoor address setup (Start – End) on the power indicator is from 00 to 7F.
The Start and End address of the power indicator refers to the first and last address of the indoor unit group.

Ex) Indoor address "72", "73", "74", "75" ➡
Start address: 72 End address: 75.

- Press the Menu key to save the remote reading service ID and return to the initial screen

How to set Interface unit

PI-485

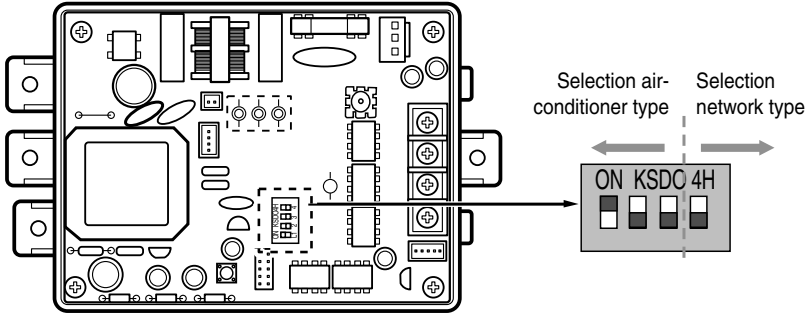

MULTIV.PLUS & MPS MULTI Products Configuration Methods

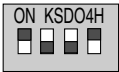

➔ 1.4 ON + ALL OFF: **MULTIV.PLUS** & MPS
Inverter Product + Central Controller



➔ 2.4 ON + ALL OFF: MPS Multi Standard Product + Central Controller

⚠ CAUTION

Wrong Products Configuration can lead to malfunctioning

How to set each Indoor Unit

■ Using wired remote controller

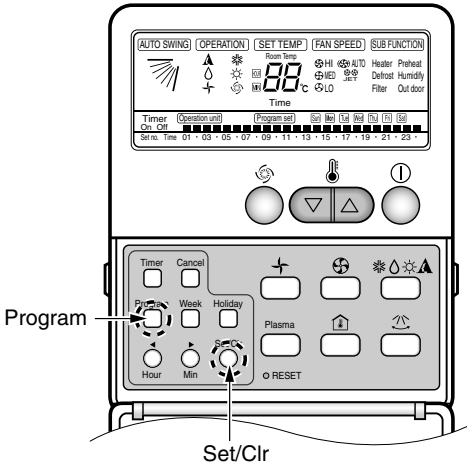

1. Press the "Program" & "Set/Clr" keys at the same time.

2. Set up the indoor address using the temperature adjustment key

• Setup range: 00-7F

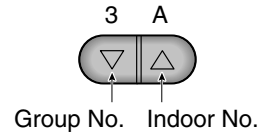

3. Press the "Program" & "Setup/Clr" keys at the same time for 3 seconds to set up the indoor address.

- The room address on the PDI is listed in the ascending order of indoor number.
Ex) If the indoor addresses are "7C", "7D", "7E" and "7F", the order of the indoor unit on the PDI are "1", "2", "3" and "4".
- The indoor numbers must be entered in sequence to be accurately recognized in the PDI.
Ex) Correct indoor unit address setup: "01", "02", "03" (setup in order)
Incorrect indoor unit address setup: "01", "02", "06"

■ Using wireless remote controller

1. Address setting mode

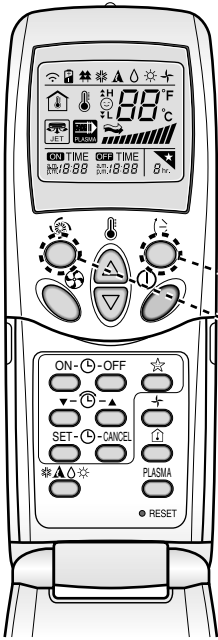

- 1) With the top left key pressed, press the Reset button.
(Press the left key for more than 3 second)
 - 2) Using the temperature adjustment key, set up the indoor unit address
- * Setup range: 00-7F

ex)

Address check

Address setting

- No use For Power Distribution Indicator
- Used for Central Control settings

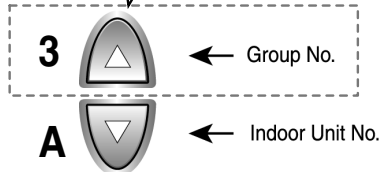

- 3) After setting the address, press the On/Off key once directing the remote controller to the indoor unit.
- 4) When indoor unit shows the setting address, the address setup is complete.
(The time and method of the address display can differ depending on the indoor unit type.)
- 5) Reset the remote controller and use it.

2. Address check mode

- 1) With the top right key pressed, press the Reset button.
(Press the left key for more than 3 seconds.)
- 2) Press the On/Off key once directing the remote controller to the indoor unit.
The indoor unit shows the setting address and the address setup is completed.
(The time and method of the address display can differ depending on the indoor unit type.)
- 3) Reset the remote controller and use it

* Depending on the manufactured date of the wired/ wireless remote controller, the above function might not work.

Since this is a function not relevant for consumer in using the product, setup the remote controller to enable address setup during installation.

* When setting the address, refer to the details on the previous page.

Installation Guide

Power Distribution Indicator and WHM should be installed in the specified cabinet which can protect the Power Distribution Indicator from water and humidity.

EX1)



EX2)

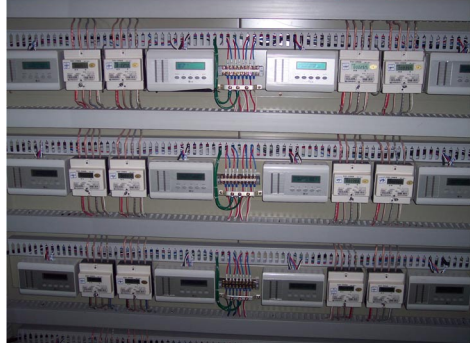

EX3)



EX4)



*** NOTE :** WHM (Watt-hour meter)

- Suppl power after completing the Wiring
- Set the Power Distribution Indicator so as to fit the usage condition.

Usage

(The distributed power consumption is based on current operating condition)

- Press the Menu key once to display the current power consumption.
- Consecutively press the Menu key to switch the screen.
- The PDI will operate normally after 3 minutes, when all options are set .

1. PWR distribution mode

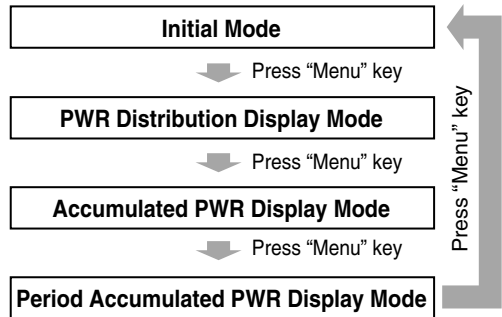
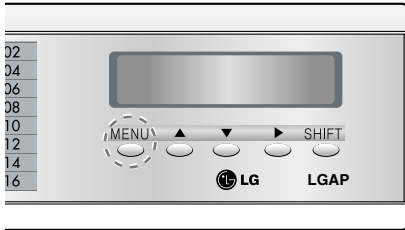

- It displays the current power consumption of each indoor unit(Watt/hour)
- When 1-2 indoor units are connected, only 1 page is displayed.
- When 4 or more indoor units are connected, press the "Shift" key to check the next page.

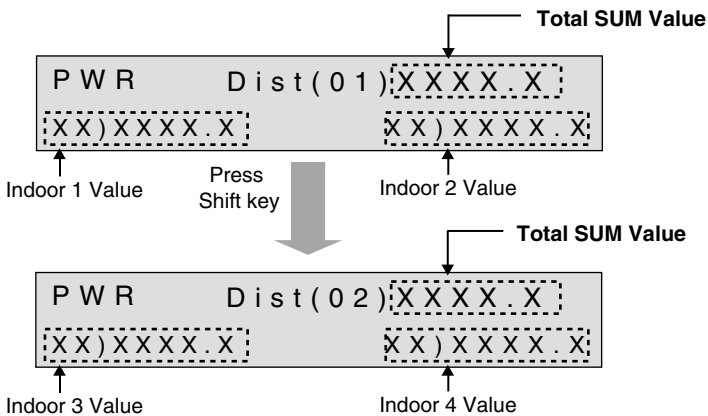

- When selecting the option for classifying the stand by power, the stand by power is displayed in the last page.

The stand by power page

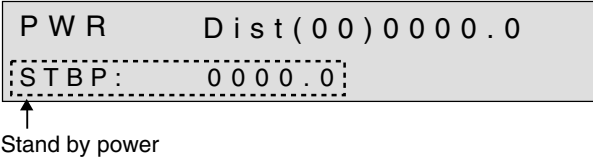

2. ACCUMPWR distribution mode

- It displays the accumulated power consumption of each indoor unit (Kwh)
- When 1-2 indoor units are connected, only 1 page is displayed.
- When 4 or more indoor units are connected, press the Shift key to check the next page.

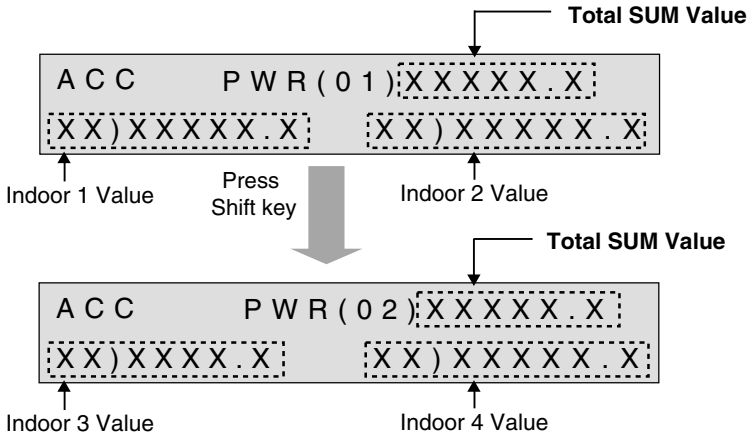

- When selecting the option for classifying the stand by power, the stand by power is displayed in the last page.

The stand by power page

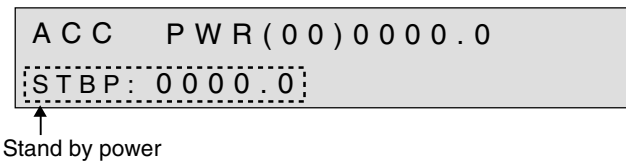

3. Period accumulated power distribution mode

- It displays the power consumption of each indoor unit (Kwh)
- When 1-2 indoor units are connected, only 1 page is displayed.
- When 4 or more indoor units are connected, press the Shift key to check the next page.

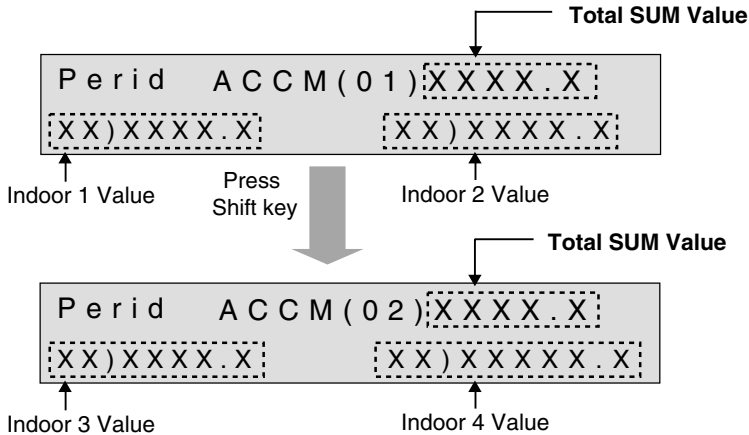

- Press the ▲ and ▼ key at the same time for 3 seconds to clear the data.
- As the function for manual check, when cleared after the check, it displays the cumulated power from the clearing point.
- When classifying the stand by power, it is shown after the last page.

The stand by power indication page

