

Register your product and get support at
www.philips.com/welcome

02

English

INTUITA

Type HD8750

USER MANUAL



EN

02

PLEASE READ THIS USER MANUAL CAREFULLY BEFORE USING THE MACHINE

CE

 **Saeco**

IMPORTANT SAFEGUARDS

When using electrical appliances, basic safety precautions should always be followed, including the following:

1. Read all instructions.
2. Do not touch hot surfaces. Use handles or knobs.
3. To protect against fire, electric shock and injury to persons do not immerse cord, plugs, or appliance in water or other liquid.
4. Close supervision is necessary when the appliance is used by or near children.
5. Unplug from outlet when not in use and before cleaning. Allow to cool before putting on or taking off parts, and before cleaning the appliance.
6. Do not operate any appliance with a damaged cord or plug or after the appliance malfunctions, or has been damaged in any manner. Return appliance to the nearest authorized service facility for examination, repair or adjustment.
7. The use of accessory attachments not recommended by the appliance manufacturer may result in fire, electric shock or injury to persons.
8. Do not use outdoors.
9. Do not let cord hang over edge of table or counter, or touch hot surfaces.
10. Do not place on or near a hot gas or electric burner, or in a heated oven.
11. Always attach plug to appliance first, then plug cord into wall outlet. To disconnect, turn any control to "off", then remove plug from wall outlet.
12. Do not use appliance for other than intended use.
13. Save these instructions.

SAVE THESE INSTRUCTIONS

CAUTION

This appliance is for household use only. Any servicing, other than cleaning and user maintenance, should be performed by an authorized service center. Do not immerse machine in water. To reduce the risk of fire or electric shock, do not disassemble the machine. There are no parts inside the machine serviceable by the user. Repair should be done by authorized service personnel only.

1. Check voltage to be sure that the voltage indicated on the nameplate corresponds with your voltage.
2. Never use warm or hot water to fill the water tank. Use cold water only.
3. Keep your hands and the cord away from hot parts of the appliance during operation.
4. Never clean with scrubbing powders or harsh cleaners. Simply use a soft cloth dampened with water.
5. For optimal taste of your coffee, use purified or bottled water. Periodic descaling is still recommended every 2-3 months.
6. Do not use caramelized or flavored coffee beans.

INSTRUCTIONS FOR THE POWER SUPPLY CORD

- A. A short power-supply cord (or detachable power-supply cord) is to be provided to reduce risks resulting from becoming entangled in or tripping over a longer cord.
- B. Longer detachable power-supply cords or extension cords are available and may be used if care is exercised in their use.
- C. If a long detachable power-supply cord or extension cord is used,
 1. The marked electrical rating of the detachable power-supply cord or extension cord should be at least as great as the electrical rating of the appliance
 2. If the appliance is of the grounded type, the extension cord should be a grounding-type 3-wire cord, and
 3. The longer cord should be arranged so that it will not drape over the counter top or table top where it can be pulled on by children or tripped over.

Congratulations on your purchase of a Saeco Intuita fully automatic coffee machine!

*To fully benefit from the support that Saeco offers, please register your product at **www.philips.com/welcome**.*

This user manual applies to HD8750.

This espresso machine is suitable for preparing espresso coffee using- whole coffee beans. In this user manual you will find all the information you need to install, use, clean and descale your machine.

CONTENTS

IMPORTANT	4
Safety Instructions	4
Warning	4
Cautions	6
Compliance with Standards	7
INSTALLATION	8
Product Overview.....	8
General Description.....	9
PREPARING FOR USE	10
Machine Packaging	10
Machine Installation	10
USING THE MACHINE FOR THE FIRST TIME	12
Circuit Priming	12
Automatic Rinse/Self-Cleaning Cycle.....	13
Manual Rinse Cycle.....	14
“INTENZA+” WATER FILTER INSTALLATION	15
ADJUSTMENTS	16
Saeco Adapting System.....	16
Adjusting the Ceramic Coffee Grinder	16
Adjusting the Aroma (Coffee Strength)	17
Adjusting the Dispensing Spout	18
Adjusting the Coffee Length	19
ESPRESSO AND COFFEE BREWING	20
Espresso and Coffee Brewing Using Coffee Beans	20
DISPENSING STEAM/CAPPUCCINO BREWING	21
HOT WATER DISPENSING	23
CLEANING AND MAINTENANCE	24
Daily Cleaning of the Machine.....	24
Daily Cleaning of the Water Tank	25
Daily Cleaning of the Classic Milk Frother	25
Weekly Cleaning of the Machine	25
Weekly Cleaning of the Classic Milk Frother	26
Weekly Cleaning of the Brew Group	26
Monthly Lubrication of the Brew Group	29
Monthly Cleaning of the Coffee Bean Hopper.....	30
DESCALING	31
UNDERSTANDING THE DIFFERENT LIGHTS	35
Control panel display.....	35
TROUBLESHOOTING	39
ENERGY SAVING	41
Stand-by	41
Disposal	41
TECHNICAL SPECIFICATIONS	42
WARRANTY AND SERVICE	42
Warranty.....	42
Service	42
ORDERING MAINTENANCE PRODUCTS	43

IMPORTANT

Safety Instructions

This machine is equipped with safety features. Nevertheless read the safety instructions carefully and only use the machine as described in these instructions to avoid accidental injury or damage.

Keep this user manual for future reference.



The term **WARNING** and this icon warn against possible severe injuries, danger to life and/or damage to the machine.



The term **CAUTION** and this icon warn against slight injuries and/or damage to the machine.



This icon requests to read carefully this instruction manual, before performing any use or maintenance operation.

Warning

- Connect the machine to a wall socket with a voltage matching the technical specifications of the machine.
- Do not let the power cord hang over the edge of a table or counter, or touch hot surfaces.
- Never immerse the machine, mains plug or power cord in water (danger of electrical shock!).
- Never direct the hot water jet towards body parts: danger of burning!
- Do not touch hot surfaces. Use handles and knobs.

- Remove the mains plug from the wall socket:
 - If a malfunction occurs.
 - If the machine will not be used for a long time.
 - Before cleaning the machine.

Pull on the plug, not on the power cord. Do not touch the mains plug with wet hands.

- Do not use the machine if the mains plug, the power cord or the machine itself is damaged.
- Do not make any modifications to the machine or its power cord. Only have repairs carried out by a service centre authorised by Philips to avoid a hazard.
- The machine should not be used by children younger than 8 years old.
- The machine can be used by children of 8 years and upwards if they have previously been instructed on the correct use of the machine and made aware of the associated dangers or if they are supervised by an adult.
- Cleaning and maintenance should not be carried out by children unless they are more than 8 years old and supervised by an adult.
- Keep the machine and its power cord out of reach of children under 8 years old.
- The machine may be used by persons with reduced physical, sensory or mental capabilities or lacking sufficient experience and/or skills if they have previously been instructed on the correct use of the machine and made aware of the associated dangers or if they are supervised by an adult.

- Children should be supervised to ensure that they do not play with the machine.
- Never insert fingers or other objects into the coffee grinder.

Cautions

- The machine is for household use only. It is not intended for use in environments such as canteens, shop staff kitchens, offices, farms or other work environments.
- Always put the machine on a flat and stable surface.
- Do not place the machine on hot surfaces, directly next to a hot oven, heater units or similar sources of heat.
- Only put coffee beans into the coffee bean hopper. If ground coffee, instant coffee or any other substance is put in the coffee bean hopper, it may damage the machine.
- Let the machine cool down before inserting or removing any parts.
- Never use warm or hot water to fill the water tank. Use only cold non sparkling drinking water.
- Never clean with scrubbing powders or harsh cleaners. Simply use a soft cloth dampened with water.
- Descale your machine regularly. The machine indicates when descaling is needed. Not doing this will make your appliance stop working properly. In this case repair is not covered under your warranty!
- Do not keep the machine at temperature below 0 °C. Residue water in the heating system may freeze and cause damage.

- Do not leave water in the water tank when the machine is not used over a long period of time. The water can be contaminated. Use fresh water every time you use the machine.

Compliance with Standards

The machine complies with art.13 of the Italian Legislative Decree dated 25 July 2005, no. 151 "Implementation of the Directives 2005/95/EC, 2002/96/EC and 2003/108/EC on the restriction of the use of certain hazardous substances in electrical and electronic equipment, as well as waste disposal".

This machine complies with EU Directive 2002/96/EC.

This Philips appliance complies with all the applicable standards and regulations relating to the exposure to electromagnetic fields.

INSTALLATION

Product Overview

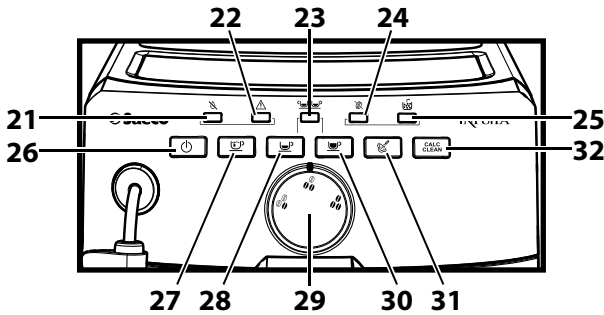
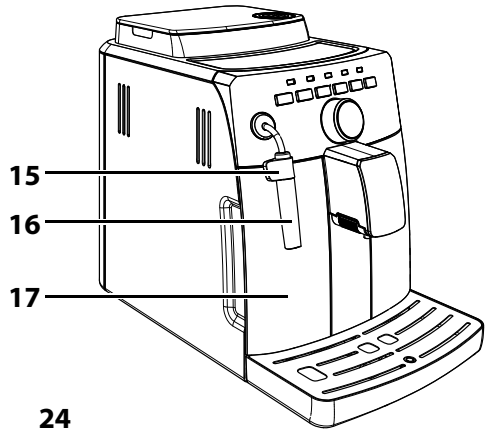
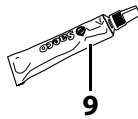
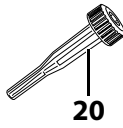
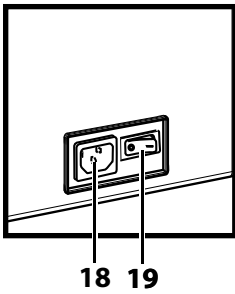
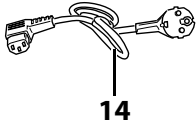
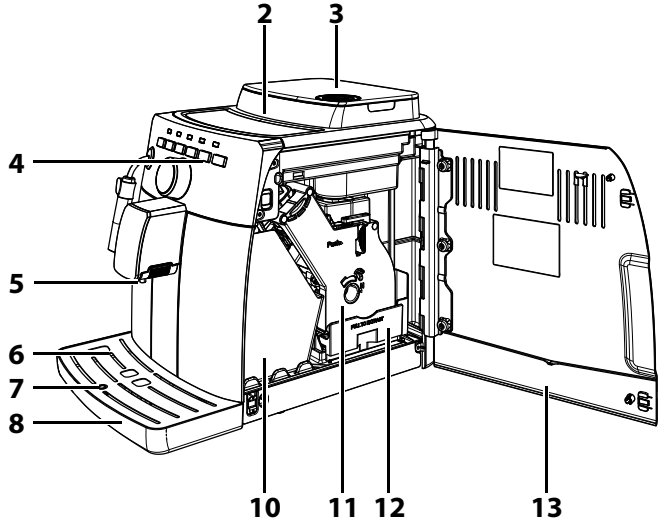
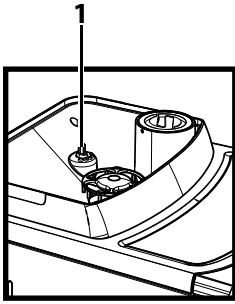

General Description

1. Coffee grinder adjustment pin
2. Coffee bean hopper
3. Coffee bean hopper lid
4. Control panel
5. Coffee dispensing spout
6. Cup holder grill
7. Full drip tray indicator
8. Drip tray
9. Grease for the brew group - to be purchased separately
10. Coffee grounds drawer
11. Brew group
12. Coffee residues drawer
13. Service door
14. Power cord
15. Wand protective gripper
16. Classic Milk Frother (for hot water/steam wand)
17. Water tank
18. Power cord socket
19. Power button
20. Coffee grinder adjustment key
21. "No water" light
22. "Warning" light
23. "Double coffee" light
24. "No coffee" light
25. "Coffee grounds drawer" light
26. ON/OFF button
27. Hot water dispensing button
28. Espresso brew button
29. "Aroma" selector switch
30. Coffee brew button
31. Steam dispensing button
32. Descaling button
33. Descaling solution- to be purchased separately

PREPARING FOR USE

Machine Packaging

The original packaging has been designed and constructed to protect the machine during transport. We recommend keeping the packaging material for possible future transport.

Machine Installation

1 Remove the drip tray with grill from the packaging.

2 Remove the machine from the packaging.

3 For best use, it is recommended to:

- Choose a safe, level surface, where there will be no danger of overturning the machine or being injured.
- Choose a location that is sufficiently well-lit, clean and near an easily reachable socket.
- Allow for a minimum distance from the sides of the machine as shown in the illustration.

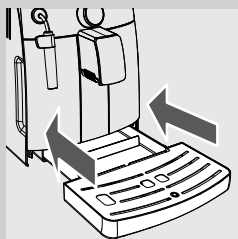
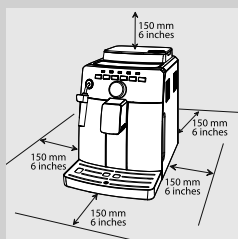

4 Insert the drip tray with grill into the machine. Make sure it is fully inserted.



Note:

The drip tray collects the water that comes out of the dispensing spout during each rinse/self-cleaning cycle, as well as coffee that might be spilled during beverage preparation. Empty and wash the drip tray daily and each time the full drip tray indicator is raised.

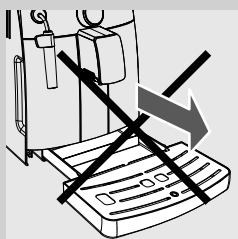

Caution:

NEVER remove the drip tray when the machine has just been turned on. Wait a couple of minutes for the machine to carry out a rinse/self-cleaning cycle.

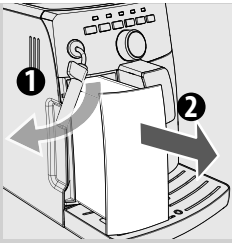

5 Remove the water tank.

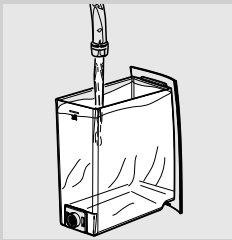

6 Rinse the water tank with fresh water.

7 Fill the water tank with fresh water up to the MAX level and reinsert it into the machine. Make sure it is fully inserted.

! **Caution:**

Never fill the water tank with warm, hot, sparkling water or any other liquid, as this may cause damage to the water tank and the machine.



8 Remove the coffee bean hopper lid and slowly pour the coffee beans into the coffee bean hopper.

≡ **Note:**

do not pour too many coffee beans into the coffee bean hopper as this will reduce the grinding performance of the machine.

! **Caution:**

Only coffee beans must be put into the coffee bean hopper. Ground coffee, instant coffee, caramelized coffee or any other object may damage the machine.

9 Put the lid on the coffee bean hopper.

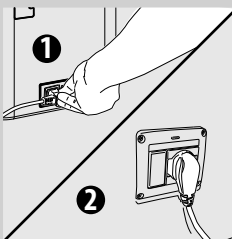

10 Insert the plug into the socket on the back of the machine.

11 Insert the plug of the other end of the power cord into a wall socket with suitable power voltage.

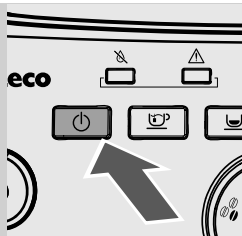

12 The "⏻" button blinks on the control panel. Press the "⏻" button to turn on the machine.

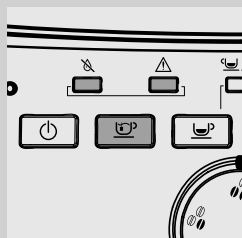

13 The "⚠" "⚠" "⚠" lights and the "☕" button light start to blink slowly to indicate that the water circuit needs to be primed.

USING THE MACHINE FOR THE FIRST TIME

When using the machine for the first time, the following activities need to happen:

- 1) You need to prime the circuit.
- 2) The machine will perform an automatic rinse/self-cleaning cycle.
- 3) You need to initiate a manual rinse cycle.

Circuit Priming

During this process fresh water flows through the internal circuit of the machine and the machine warms up. This takes a few minutes.

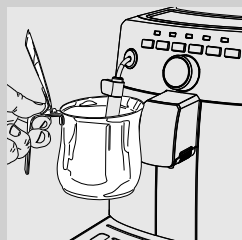

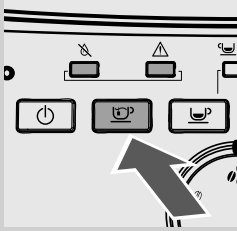

1 Insert a container under the Classic Milk Frother.

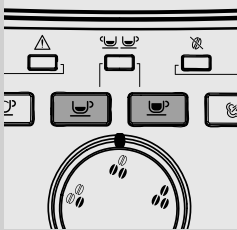

- 2 Press the " button to start the cycle. The machine starts the automatic priming of the circuit by dispensing some water through the Classic Milk Frother.



- 3 When the process is complete, the " and " buttons will blink. The machine is in the warm-up mode.

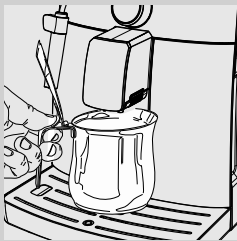

Automatic Rinse/Self-Cleaning Cycle

When warm-up is completed, the machine automatically performs a rinse/self-cleaning cycle of the internal circuits with fresh water. This takes less than a minute.



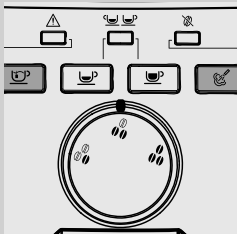

- 4 Place a container under the dispensing spout to catch the small amount of dispensed water.







- 5 The " and " buttons blink during the entire process.

- 6 Wait for the cycle to finish automatically.

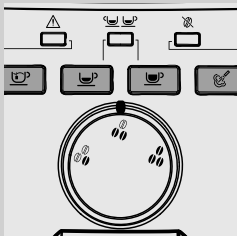
 **Note:**

You can stop the dispensing process by pressing either the " or the " button.



- 7 When the above steps are complete, check that the ", ", " and " buttons are lit.

Manual Rinse Cycle

During this process a coffee is brewed and fresh water flows through the steam/hot water circuit. This takes a few minutes.

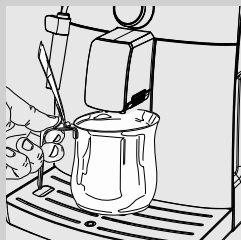

- 1 Place a container under the dispensing spout.
- 2 Check that the "☺", "☹", "☹" and "☹" lights blink permanently.
- 3 Press the "☹" button. The machine starts dispensing water.
- 4 When the dispensing has finished, empty the container.
Repeat the operations from step 1 to step 3 twice, then continue with step 5.



- 5 Insert a container under the Classic Milk Frother.

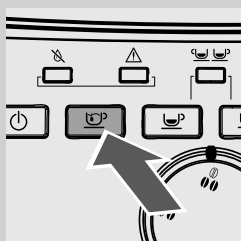

- 6 Press the "☹" button to start dispensing hot water.
- 7 Dispense water until the no water light "☹" is permanently on.

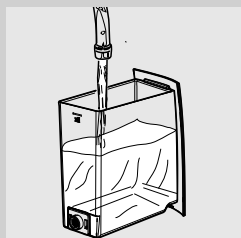

- 8 At the end, fill the water tank again up to the MAX level. Now the machine is ready for coffee brewing.

Note:

If the machine has not been used for at least two weeks, it will automatically perform an automatic rinse/self-cleaning cycle. Following this, you need to initiate a manual rinse cycle as described above.

The automatic rinse/self-cleaning cycle also starts automatically when the machine has been in stand-by mode or turned off for more than 15 minutes.

At the end of the cycle, it is possible to brew a coffee.

"INTENZA+" WATER FILTER INSTALLATION

We recommend installing the "INTENZA+" water filter as this prevents limescale build-ups and preserves a more intense aroma to your espresso coffee.

The INTENZA+ water filter can be purchased separately. For further details, please refer to the maintenance products page in this user manual.

Water is a crucial part of every espresso, so it's most important to always have it professionally filtered. Using the "INTENZA+" water filter will prevent mineral deposits from building up and improve your water quality.

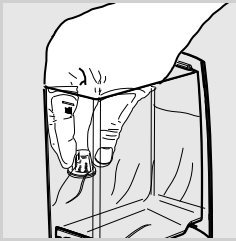

- 1** Remove the small white filter from the water tank and store it in a dry place.

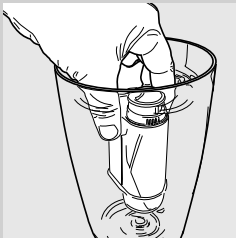

- 2** Remove the "INTENZA+" water filter from its packaging, immerse it vertically (with the opening positioned upwards) in cold water and gently press the sides so as to let the air bubbles out.

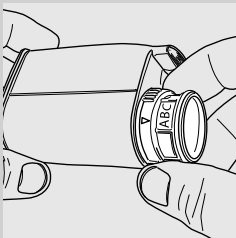

- 3** Set the filter according to the water hardness in your area. The settings can be found on the filter packaging.
 A = Soft water
 B = Hard water (standard)
 C = Very hard water

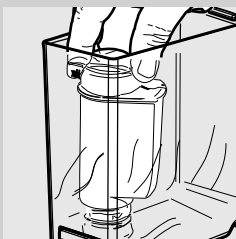

- 4** Insert the filter into the empty water tank. Press it down until it cannot move any further.

- 5 Fill the water tank with fresh water and reinsert it into the machine. Write down the date of the next water filter replacement (+ 2 months).
- 6 Dispense all the water of the tank by using the hot water function (see the "Hot Water Dispensing" chapter).
- 7 Fill the water tank again.

ADJUSTMENTS

The machine allows for certain adjustments so that you can brew the best tasting coffee possible.

Saeco Adapting System

Coffee is a natural product and its characteristics may change according to its origin, blend and roast. The machine is equipped with a self-adjusting system that allows the use of all types of coffee beans available on the market (not for caramelized beans).

The machine automatically adjusts itself after brewing several cups of coffee to optimise the extraction of the coffee in relation to the compactness of the ground coffee.

Adjusting the Ceramic Coffee Grinder

Ceramic coffee grinders always guarantee accurate and perfect grinding and coarseness for every coffee speciality.

This technology provides for full aroma preservation, delivering the truly Italian taste in every cup.



Warning:

The ceramic coffee grinder contains moving parts that may be dangerous. Do not insert fingers or other objects. Only adjust the ceramic coffee grinder using the grinder adjustment key.

You can adjust the ceramic grinders to set the coffee grinding to your personal taste.



Warning:

the grinder adjustment knob inside the coffee bean hopper, must be turned only when the ceramic coffee grinder is in use.

This adjustment can be carried out by pressing and turning the grinder adjustment knob inside the coffee bean hopper, using the appropriate key provided with the machine.

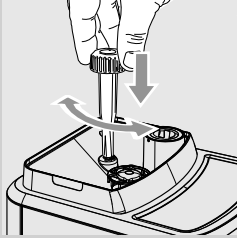

- 1 Press and turn the grinder adjustment knob one notch at a time. You will taste the difference after brewing 2-3 cups of coffee.

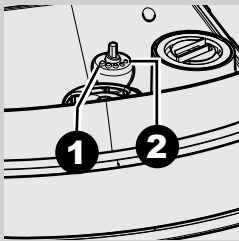

- 2 The reference marks inside the coffee bean hopper indicate the grind setting. There are 5 different grind settings to choose from position 1 for coarse grind - lighter taste to position 2 for fine grind - bolder taste.

When you adjust the ceramic coffee grinder to a finer setting, your coffee will taste stronger. For a milder coffee taste, adjust the ceramic coffee grinder to a coarser setting.

Adjusting the Aroma (Coffee Strength)

Choose your favourite coffee blend and adjust the amount of coffee to be ground according to your personal taste.



Note:

Selection must be made prior to selecting coffee.

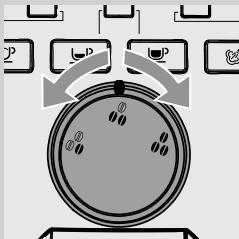

It is possible to choose from three types of aroma by turning the knob. The aroma will vary depending on the chosen position:

 = mild aroma

 = medium aroma

 = strong aroma

Adjusting the Dispensing Spout

The height of the dispensing spout can be adjusted to better fit the dimensions of the espresso cups that you wish to use.

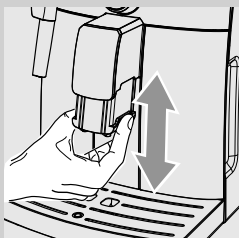

Move the dispensing spout up or down with your fingers to adjust its height as shown in the image.



The recommended positions are:
For the use of small cups.



For the use of large cups.



Two cups can be placed under the dispensing spout to brew two coffees at the same time.

Adjusting the Coffee Length

The machine allows the amount of brewed espresso coffee to be adjusted according to taste and cup size.

Each time the "☺" or "☺☺" button is pressed, the machine brews a pre-set amount of coffee. Each button may be individually programmed for a specific brew setting.

The following procedure describes the programming of the "☺" button.



- 1 Place a cup under the dispensing spout.

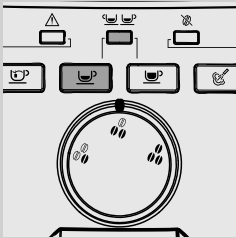

- 2 Press and hold the "☺" button. The "☺" button and the "☺☺" light blink during this phase. Release the button: the machine is now in programming mode. The machine starts brewing coffee.

- 3 When the desired quantity of coffee is in the cup, press the "☺" button.

Now the "☺" button is programmed; each time it is pressed, the machine will brew the same amount of espresso that was just pre-set.



Note:

To program the "☺☺" brew button, the same steps should be followed. Press the "☺☺" button to stop brewing when the desired amount of coffee is reached.

ESPRESSO AND COFFEE BREWING

Espresso and Coffee Brewing Using Coffee Beans.

Before brewing a coffee, check that both the water tank and the coffee bean hopper are full.

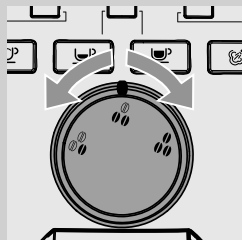

- 1 Turn the aroma selector switch to select the desired aroma.

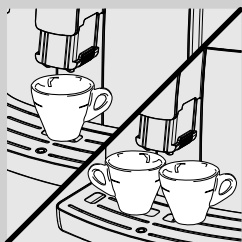

- 2 Place 1 or 2 cups under the dispensing spout.

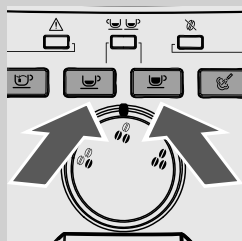

- 3 Press the “☕” button for an espresso and the “☕☕” button for a coffee.

- 4 To brew 1 cup of espresso or coffee, press the desired button once.

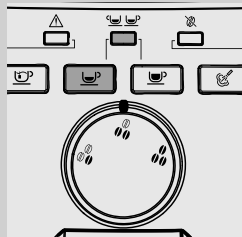

- 5 To brew 2 cups of espresso or coffee, press the desired button twice consecutively. The “☕☕” light turns on.

Note:

In this operating mode, the machine automatically grinds and doses the proper amount of coffee. Brewing two espressos requires two grinding and brewing cycles, automatically carried out by the machine.

- 6 After the prebrewing cycle, coffee begins to pour out of the dispensing spout.
- 7 Coffee brewing stops automatically when the pre-programmed level is reached; however, it is possible to interrupt coffee brewing by pressing the corresponding button again (“☺” espresso button or “☺” brew button).

DISPENSING STEAM/CAPPUCCINO BREWING



Warning:

Danger of burning! Dispensing may be preceded by small jets of hot water. The steam/hot water wand may reach high temperatures: never touch it with bare hands. Use the appropriate protective handle only.

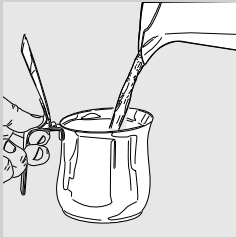

- 1 Fill 1/3 of a container with cold milk.



Note:

use cold (~5°C / 41°F) milk with a protein content of at least 3% to ensure optimum results when preparing a cappuccino. Whole milk or skimmed milk may be used depending on individual taste.

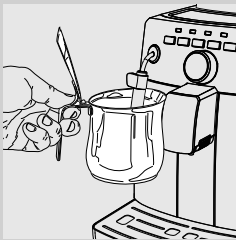

- 2 Immerse the Classic Milk Frother in milk.

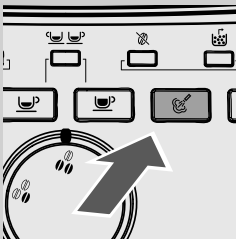

- 3 Press the “☺” button.

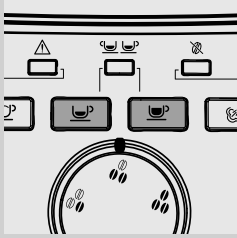

4 The machine warms up and the “☕” and “☕” buttons blink. The “🔌” button turns off.

5 When the “🔌” button turns on again, the machine starts dispensing steam.

6 Froth the milk by gently swirling the container and moving it up and down.

7 When the milk froth has the desired consistency, press the “🔌” button to stop steam dispensing.

! **Caution:**

After frothing the milk, clean the Classic Milk Frother by dispensing a small quantity of hot water into a container. For detailed cleaning instructions please see the “Cleaning and Maintenance” chapter.

☰ **Note:**

After dispensing steam, it is possible to brew an espresso or dispense hot water straight after.

HOT WATER DISPENSING

**Warning:**

Danger of burning! Dispensing may be preceded by small jets of hot water. The steam/hot water wand may reach high temperatures: never touch it with bare hands. Use the appropriate protective handle only.

Before dispensing hot water, check that the "☺", "☺", "☺" and "☺" lights are permanently on and that the water tank is full.

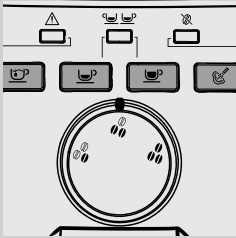

- 1 Insert a container under the Classic Milk Frother.

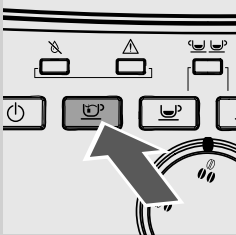

- 2 Press the "☺" button to start dispensing hot water.

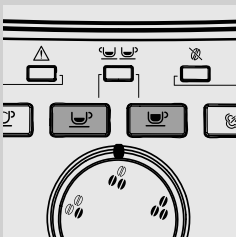

- 3 The machine warms up and the "☺" and "☺" buttons blink. The "☺" button turns off.
- 4 When the "☺" button turns on again, the machine starts dispensing hot water.
- 5 Dispense the desired amount of hot water. To stop the hot water dispensing, press the "☺" button.

CLEANING AND MAINTENANCE

Daily Cleaning of the Machine



Caution:

Timely cleaning and maintenance of your machine is very important as it prolongs the life of your machine. Your machine is continuously exposed to moisture, coffee and limescale!

The activities you need to perform and their frequency are described in detail in this chapter. Not doing this will ultimately make your machine stop working properly. This repair is NOT covered by your warranty!



Note:

- Use a soft, dampened cloth to clean the machine.
- Do not wash any removable part in the dishwasher.
- Do not immerse the machine in water.
- Do not use alcohol, solvents, and/or abrasive objects to clean the machine.
- Do not dry the machine and/or its components using a microwave and/or standard oven.

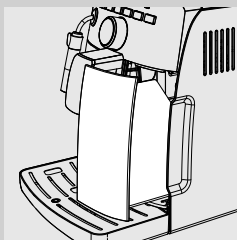

- 1** Empty and clean the coffee grounds drawer daily with the machine turned on.

Other maintenance operations can only be carried out when the machine is turned off and unplugged.

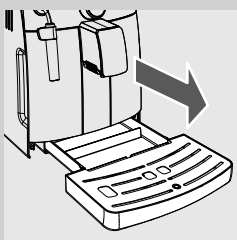

- 2** Empty and clean the drip tray. Perform this operation also when the full drip tray indicator is raised.

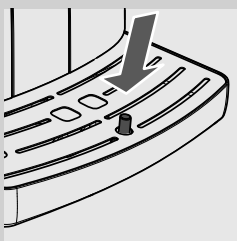

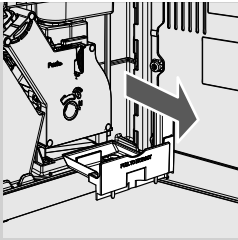

- 3 Empty and clean the coffee residues drawer located on the side of the machine. Open the service door, remove the drawer and empty the coffee residues.

Daily Cleaning of the Water Tank

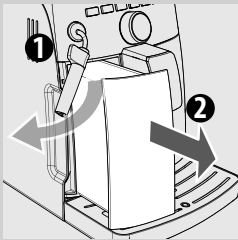

- 1 Remove the small white filter or the INTENZA+ water filter (if installed) from the water tank and wash it with fresh water.
- 2 Put the small white filter back or the INTENZA+ water filter (if installed) in its housing by gently pressing and turning it at the same time.
- 3 Fill the water tank with fresh water.

Daily Cleaning of the Classic Milk Frother

It is important that you clean the Classic Milk Frother daily or after each use as it preserves hygiene and ensures perfect milk froth consistency. After each milk frothing you always need to:

Remove the external part of the Classic Milk Frother and wash it with fresh water.

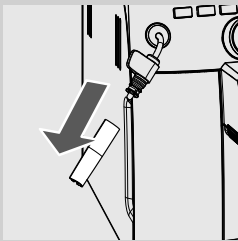

Weekly Cleaning of the Machine

Clean the seat of the drip tray.

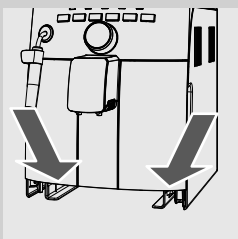

Weekly Cleaning of the Classic Milk Frother

The weekly cleaning is more thorough, since you need to disassemble all the Classic Milk Frother parts.

The following cleaning operations are required:

- 1** Remove the external part of the Classic Milk Frother. Wash it with fresh water.
- 2** Remove the upper part of the Classic Milk Frother from the steam/hot water wand.
- 3** Wash the upper part of the Classic Milk Frother with fresh water.
- 4** Clean the hot water/steam wand with a wet cloth to remove milk residues.
- 5** Put the upper part back into the steam/hot water wand (make sure it is completely inserted).
- 6** Reassemble the external part of the Classic Milk Frother.

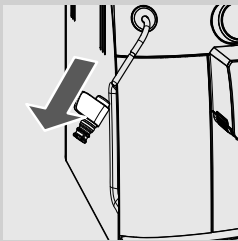
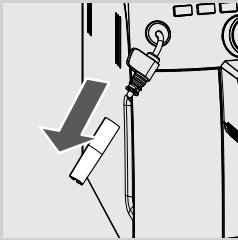

Weekly Cleaning of the Brew Group

The brew group should be cleaned every time the coffee bean hopper is filled or at least once a week.

- 1** Turn off the machine by pressing the “⏻” button and remove the plug from the socket.
- 2** Remove the coffee grounds drawer. Open the service door.

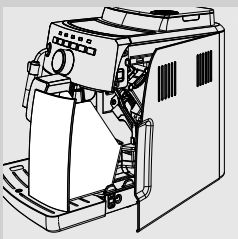
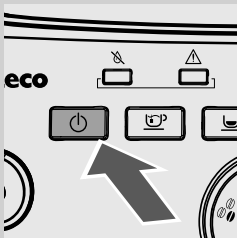

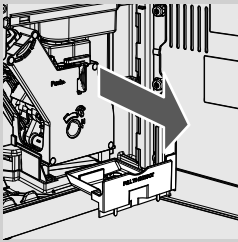

3 Remove and clean the coffee residues drawer.

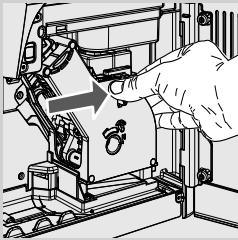

4 To remove the brew group, press the «PUSH» button and pull it by the handle.

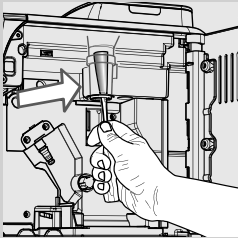

5 Thoroughly clean the coffee outlet duct with the handle of a spoon or with another rounded kitchen utensil.

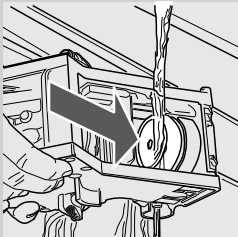

6 Thoroughly wash the brew group with lukewarm water and carefully clean the upper filter.

! **Caution:**
Do not use detergent or soap to clean the brew group.

7 Let the brew group air-dry thoroughly.

8 Thoroughly clean the inside of the machine using a soft, dampened cloth.

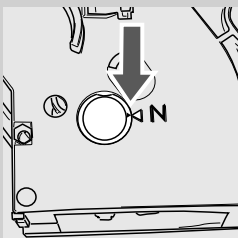

9 Make sure the brew group is in the off position; the two reference signs must match. If they do not match, proceed as described in step (10).

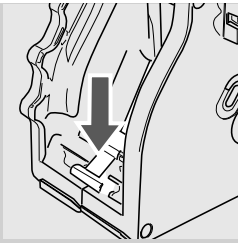

- 10** Gently pull down the lever until it is in contact with the brew group base and the two reference signs on the side of the brew group match.

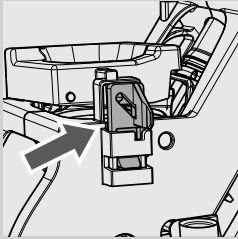

- 11** Make sure the hook to lock the brew group is in the correct position by firmly pressing the "PUSH" button until it locks into place. Check if the hook is at the top end position. If it is not, please try again.

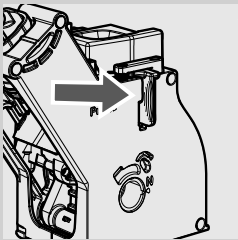

- 12** Insert the brew group in its seat again until it locks into place without pressing the "PUSH" button.

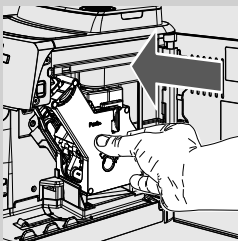

- 13** Insert the coffee residues drawer and close the service door.

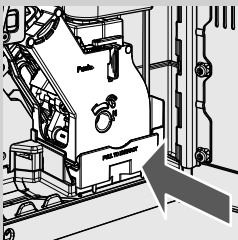

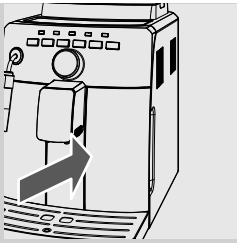

14 Insert the coffee grounds drawer.

Monthly Lubrication of the Brew Group

Lubricate the brew group after approximately 500 cups of coffee or once a month.

You can purchase the Saeco grease, used to lubricate the brew group, separately. For further details, please refer to the maintenance products page in this user manual.

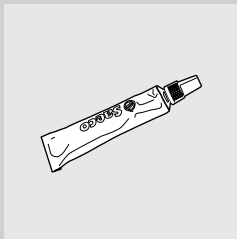

! **Caution:**

Before lubricating the brew group, clean it with fresh water and let it dry, as described in the “Weekly Cleaning of the Brew Group” chapter.

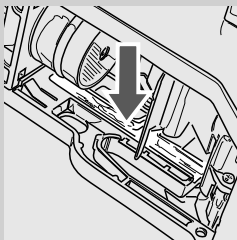

1 Apply the grease evenly on both side guides.

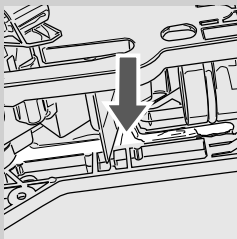

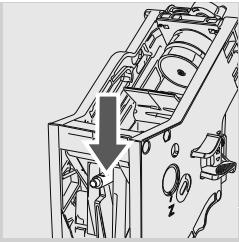

2 Also lubricate the shaft.

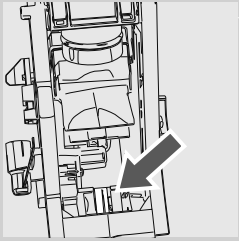

3 Insert the brew group in its seat until it locks into place (see the “Weekly Cleaning of the Brew Group” chapter). Insert the coffee residues drawer.

4 Close the service door and insert the coffee grounds drawer.

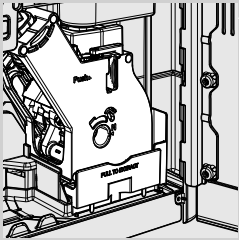

Monthly Cleaning of the Coffee Bean Hopper

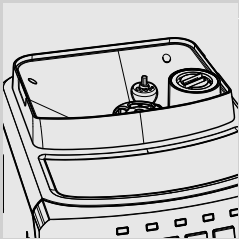

Clean the coffee bean hopper once a month when it is empty with a damp cloth to remove coffee oil. Thereafter refill it with coffee beans.

DESCALING

The descaling process takes approx. 35 minutes.



Limescale builds up inside the machine during use. It needs to be removed regularly as it may clog the water and coffee circuit of your machine. The machine indicates when descaling is needed. If the " **CALC CLEAN** " light is permanently on, the machine must be descaled.



Caution:

Not doing this will ultimately make your machine stop working properly, and in this case repairing is NOT covered by your warranty.



Use the Saeco descaling product only, as it has been designed to ensure better machine performance. You can purchase separately the SAECO descaling solution. For further details, please refer to the maintenance products page in this user manual.



Warning:

never drink the descaling solution or any products dispensed until the cycle has been carried out to the end. Never use vinegar as a descaling solution.



Note:

Do not turn off the machine during the descaling cycle. Otherwise you will need to restart the descaling cycle from the very beginning.

To execute the descaling cycle, follow the steps below:

Before descaling:

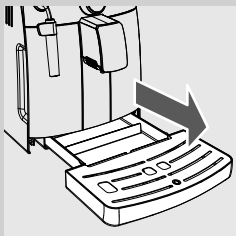

- 1 Empty the drip tray.

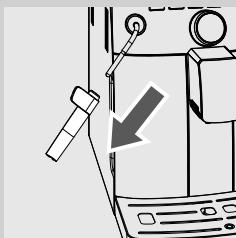

- 2 Remove the Classic Milk Frother from the steam/hot water wand.

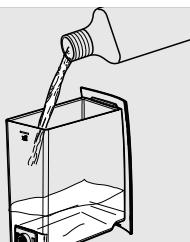

3 Remove the "INTENZA+" water filter (if installed) from the water tank if it was installed.

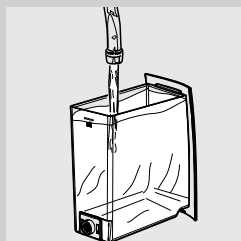

4 Remove the water tank and pour the entire content of the Saeco descaling solution. Fill the water tank with fresh water up to the MAX level.

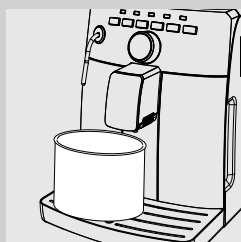

5 Place the water tank back into the machine.

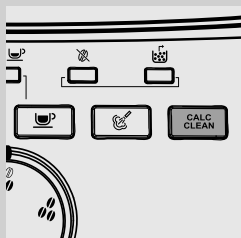

6 Place a large container (1.5 l) under the steam/hot water wand and the dispensing spout.



7 Press and hold the " **CALC CLEAN** " button for 3 seconds. When the button starts blinking, release it to start the cycle. The " **CALC CLEAN** " button blinks during the whole descaling cycle.

8 The steam/hot water wand ("  ") button permanently on) and the dispensing spout ("  ") button permanently on) now start dispensing the descaling solution.

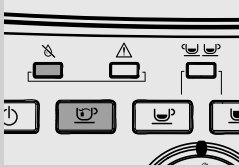
**Note:**

Press the "CALC CLEAN" button to pause the descaling cycle. To resume the cycle, press the "CALC CLEAN" button again. This allows you to empty the container or to leave the machine unattended for a short time.

- 9 When the descaling solution is finished, the "☒" light turns on and the "C" button blinks.

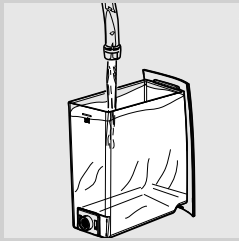

- 10 Empty the container.

- 11 Remove the water tank, rinse it and fill it up to the MAX level with fresh water. Place it back into the machine.

- 12 Empty the drip tray and place it back. Put the container back under both the steam/hot water wand and the dispensing spout.

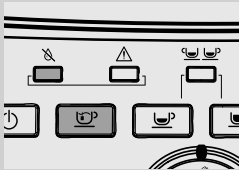

- 13 Press the "C" button to perform the rinse cycle.

- 14 When the rinse cycle is complete, the "☒" light turns on and the "C" button blinks.

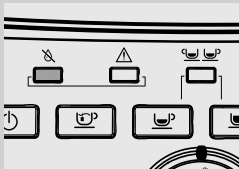

- 15 Repeat steps 10 – 14; then continue to step 16.

- 16 At the end of the 2nd rinse cycle, the "CALC CLEAN" light turns off and only the "☒" light stays on; the descaling process is complete.

**Note:**

If the tank is not filled up to the MAX level for the rinse cycle, the "CALC CLEAN" light keeps on blinking and another cycle may need to be performed; repeat steps 10 to 14.

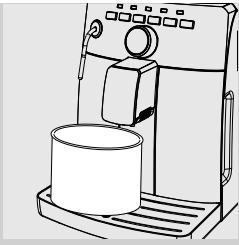

- 17** Empty the container and place it back under both the steam/hot water wand and the dispensing spout.

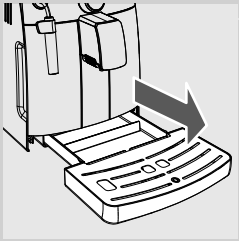

- 18** Empty the drip tray and place it back.

- 19** The machine warms up and initiates the rinse cycle to prepare for product brewing.

- 20** Place the "INTENZA+" water filter (if installed) back in the water tank and reinsert the Classic Milk Frother.





 **Note:**



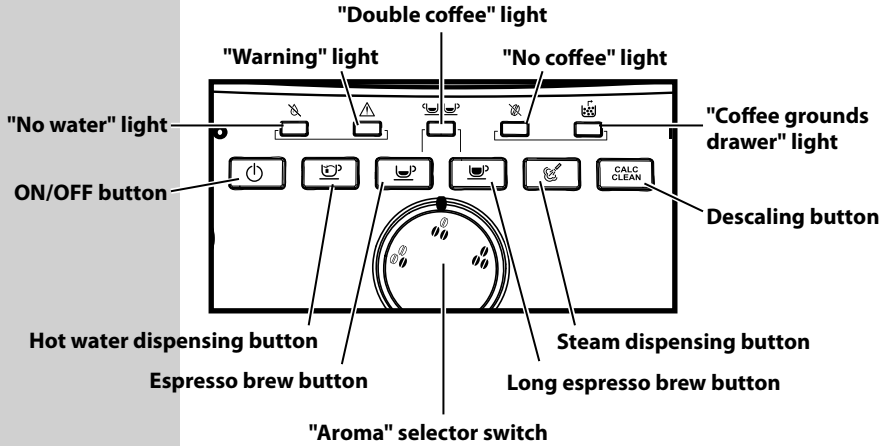

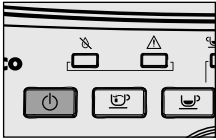
At the end of the descaling cycle, wash the brew group as described in the "Weekly Cleaning of the Brew Group" chapter.

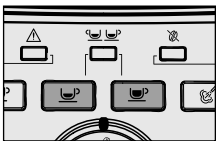

UNDERSTANDING THE DIFFERENT LIGHTS

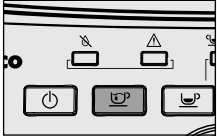
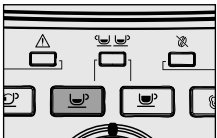
Control panel display

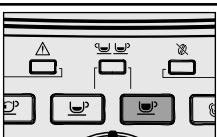
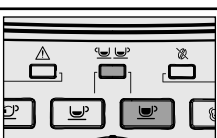
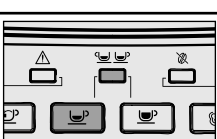

Light icons	Meaning	Action
 <p>BLINKING</p>	Machine in stand-by.	Press the "⏻" button to turn on the machine.
 <p>SLOW BLINKING</p>	The machine is performing the rinse phase.	The machine ends the cycle automatically. Press the "☕" or "☁" button to stop the cycle before the end.
 <p>SLOW BLINKING</p>	The machine is warming up to brew espresso and dispense hot water or steam.	
 <p>STEADY ON</p>	The machine is ready for use.	

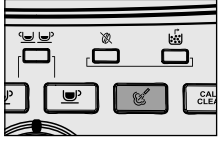
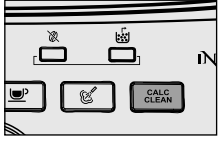
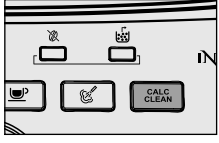
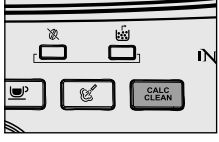
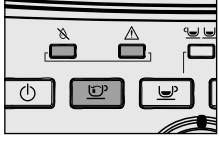
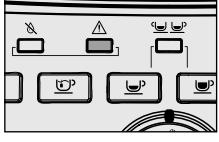

Light icons	Meaning	Action
 <p>STEADY ON</p>	<p>The machine is in the hot water dispensing phase.</p>	
 <p>STEADY ON</p>	<p>The machine is brewing one cup of espresso.</p>	
 <p>STEADY ON</p>	<p>The machine is brewing 2 (two) cups of espresso.</p>	
 <p>STEADY ON</p>	<p>The machine is brewing one cup of coffee.</p>	
 <p>STEADY ON</p>	<p>The machine is brewing 2 (two) cups of coffee.</p>	
 <p>SLOW BLINKING</p>	<p>The machine is programming the amount of espresso to brew.</p>	
 <p>SLOW BLINKING</p>	<p>The machine is programming the amount of coffee to be brewed.</p>	

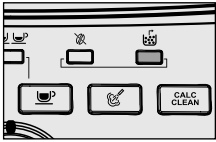
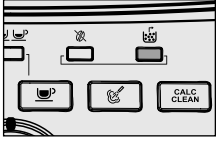
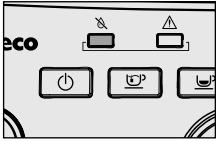
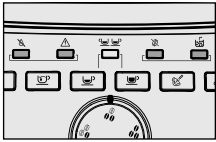
Light icons	Meaning	Action
 <p>STEADY ON</p>	<p>The machine is dispensing steam or frothing milk.</p>	
 <p>STEADY ON</p>	<p>The machine needs to be descaled.</p>	<p>Start the descaling cycle. If not descaled regularly, the machine will stop working correctly. Any malfunction will not be covered by the warranty.</p>
 <p>SLOW BLINKING</p>	<p>The machine is in the descaling phase.</p>	<p>Press the "CALC CLEAN" button to stop the cycle.</p>
 <p>FAST BLINKING</p>	<p>Machine "PAUSED" during the descaling cycle.</p>	<p>Press the "CALC CLEAN" button to start the cycle.</p>
 <p>SLOW BLINKING</p>	<p>Prime the circuit.</p>	<p>Fill the tank with fresh water and prime the water circuit as described in the "Using the Machine for the First Time" chapter.</p>
 <p>SLOW BLINKING</p>	<ul style="list-style-type: none"> - Close the service door. - Insert the brew group. 	<p>Make sure that all components have been correctly inserted and closed.</p>
 <p>STEADY ON</p>	<p>The coffee bean hopper is empty.</p>	<p>Refill the coffee bean hopper with coffee beans and restart the brewing cycle.</p>

Light icons	Meaning	Action
 <p>FAST BLINKING</p>	The coffee grounds drawer is not inserted.	Empty the coffee grounds drawer and wait for the light to blink slowly before reinserting it.
 <p>STEADY ON</p>	The coffee grounds drawer and the drip tray are full.	With the machine turned on, empty the coffee grounds drawer and the drip tray. If the coffee grounds drawer is emptied with the machine turned off, or when the indicator light is not illuminated, the coffee cycles counter is not reset. For this reason, the indicator light indicating to empty the coffee grounds drawer may blink even when it is not full.
 <p>STEADY ON</p>	The water tank is empty.	Fill the water tank with fresh water.
 <p>SLOW BLINKING</p>	A fault has occurred in the machine and espresso, water or steam cannot be dispensed.	Turn off the machine, wait for 30 seconds and then turn it on again. Try this 2 or 3 times. If the machine does NOT start, contact the Philips Saeco hotline.

TROUBLESHOOTING

This chapter summarizes the most common problems you could encounter with your machine. If you are unable to solve the problem with the information below, visit www.philips.com/support for a list of frequently asked questions or contact the Philips Saeco hotline in your country. The contact details can be found in the warranty booklet packed separately or on www.philips.com/support.

Machine actions	Causes	Solutions
The machine does not turn on.	The machine is not connected to the electric network.	Connect the machine to the electric network.
Coffee is not hot enough.	The cups are cold.	Preheat the cups with hot water.
The drip tray gets filled although no water is drained.	Sometimes water is drained automatically by the machine into the drip tray to manage the rinsing of the circuits and ensure optimum machine performance.	This is a standard operating procedure.
The fast blinking red  light is always displayed on the machine.	The coffee grounds drawer was emptied with the machine off.	The coffee grounds drawer must always be emptied with the machine on. Wait until the red  light starts blinking more slowly before reinserting the drawer.
No hot water or steam is dispensed.	The hole of the steam wand is clogged.	Clean the hole of the steam wand using a pin.  Caution: Make sure that the machine is off and has cooled down before performing this operation.
	The Classic Milk Frother is dirty.	Clean the Classic Milk Frother.
Coffee does not have enough crema. (See note)	The blend is unsuitable, coffee is not freshly roasted or the grind is too coarse.	Change coffee blend or adjust the grind as explained in the "Adjusting the Coffee Grinder" section.
The machine takes a long time to warm up or the amount of water dispensed from the wand is too little.	The machine circuit is clogged by limescale.	Descale the machine.
The brew group cannot be removed.	The brew group is out of place.	Turn on the machine. Close the service door. The brew group automatically returns to the initial position.
	The coffee grounds drawer is inserted.	Remove the coffee grounds drawer before removing the brew group.
There is a lot of ground coffee under the brew group.	Coffee is not suitable for automatic machines.	It may be necessary to change the type of coffee or the coffee grinder settings.

Machine actions	Causes	Solutions
The machine grinds the coffee beans but no coffee comes out. (See note)	There is no water.	Fill the water tank and prime the circuit (see the "Using the Machine for the First Time" section).
	The brew group is dirty.	Clean the brew group (see the "Weekly Cleaning of the Brew Group" section).
	The circuit is not primed.	Prime the circuit (see the "Using the Machine for the First Time" section).
	This might occur when the machine is automatically adjusting the dose.	Brew a few cups of coffee as described in the "Saeco Adapting System" section.
Coffee is too weak. (See note)	The dispensing spout is dirty.	Clean the dispensing spout.
	This might occur when the machine is automatically adjusting the dose.	Brew a few cups of coffee as described in the "Saeco Adapting System" section.
Coffee is brewed slowly. (See note)	The coffee grind is too fine.	Change coffee blend or adjust the grind as explained in the "Adjusting the Coffee Grinder" section.
	The circuit is not primed.	Prime the circuit (see the "Using the Machine for the First Time" section).
	The brew group is dirty.	Clean the brew group (see the "Weekly Cleaning of the Brew Group" section).
Coffee leaks out of the dispensing spout.	The dispensing spout is clogged.	Clean the dispensing spout and its holes.

**Note:**

These problems can be considered normal if the coffee blend has been changed or if the machine has just been installed. In this case wait until the machine performs a self-adjusting operation as described in the "Saeco Adapting System" chapter.

ENERGY SAVING

Stand-by



The Saeco fully automatic espresso machine is designed for energy saving proven by the Class A energy label.

After 30 minutes of inactivity, the machine turns off automatically. If a product has been brewed the machine performs a rinse cycle.

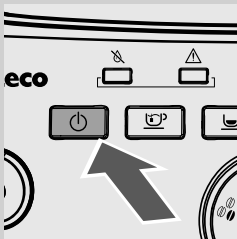

In stand-by mode, the energy consumption is below 1Wh.

To turn on the machine, press this button (if the power button on the back of the machine is set to "I"). If the boiler is cold the machine performs a rinse cycle.

Disposal



Do not throw away the machine with the normal household waste at the end of its life, but hand it in at an official collection point for recycling. By doing this, you help to preserve the environment.

- Packaging materials can be recycled.
- Machine: unplug the machine and cut the power cord.
- Deliver the appliance and power cord to a service centre or public waste disposal facility.

This product complies with EU Directive 2002/96/EC.

The symbol on the product or on its packaging indicates that this product may not be treated as household waste. Instead, it shall be handed over to the applicable collection point for the recycling of electrical and electronic equipment.

By ensuring this product is disposed of correctly, you will help prevent potential negative consequences for the environment and human health, which could otherwise be caused by inappropriate waste handling of this product. For more detailed information about recycling of this product, please contact your local city office, your household waste disposal service or the shop where you purchased the product.

TECHNICAL SPECIFICATIONS

The manufacturer reserves the right to make changes to the technical specifications of the product.

Nominal Voltage - Power Rating - Power Supply	See label on the inside of the service door
Housing material	Thermoplastic material
Size (w x h x d)	256 x 340 x 440 mm
Weight	9 kg
Power cord length	800 - 1200 mm
Control panel	Front panel
Classic Milk Frother	Especially for cappuccinos
Maximum height of the cup under the dispensing spout (mm)	110
Water Tank	1.5 litres - Removable type
Coffee bean hopper capacity	300 g
Coffee grounds drawer capacity	10
Pump pressure	15 bar
Boiler	Stainless Steel
Safety devices	Thermal fuse

WARRANTY AND SERVICE

Warranty

For detailed information on your warranty and related conditions, please read the warranty booklet supplied separately.

Service

We want to ensure that you remain satisfied with your machine. If not done already, please register your purchase at **www.philips.com/welcome**, so that we can stay in contact with you and send you cleaning and descaling reminders.

If you need service or support, please visit the Philips website at www.philips.com/support or contact the Philips Saeco hotline in your country. The contact details can be found in the warranty booklet supplied separately or on **www.philips.com/support**.

ORDERING MAINTENANCE PRODUCTS

For cleaning and descaling, use Saeco maintenance products only. You can purchase the products at the Philips online shop (if available in your country) at www.shop.philips.com/service, from your local dealer or authorised service centres.

If you have any difficulties obtaining maintenance products for your machine, please contact the Philips Saeco hotline in your country. The contact details can be found in the warranty booklet supplied separately or on www.philips.com/support.

Overview of maintenance products



- Descaling solution CA6700



- INTENZA+ water filter CA6702

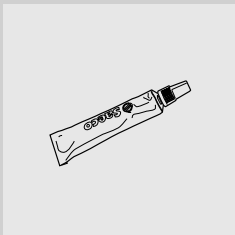

- Grease HD5061



- Maintenance kit CA 6706

Blank lined writing paper with horizontal lines and corner registration marks.



The manufacturer reserves the right to make changes without prior notice.

www.philips.com/saeco



421946009231

Rev.00 15-11-13