



# 760000S

Not made with natural rubber latex.

## **CLINICAL PLUS ALTERNATING PRESSURE / LOW AIR LOSS MATTRESS SYSTEM**



## **USER MANUAL**

**Important: Do not operate the Mattress System without first reading and understanding this manual! Save this manual for future use.**

**Info: The most current version of this manual can be found online at [www.grahamfield.com](http://www.grahamfield.com).**

# CONTENTS

INTRODUCTION.....	3
INTENDED USE OF THIS DEVICE.....	3
CONTRAINDICATION.....	3
IMPORTANT SAFETY PRECAUTIONS.....	4
DANGER.....	4
WARNING.....	5
NOTICE.....	6
EQUIPMENT SYMBOLS.....	7
PRODUCT DESCRIPTION.....	8
PUMP AND MATTRESS SYSTEM.....	8
PUMP: FRONT.....	8
PUMP: REAR.....	8
PUMP: FRONT PANEL.....	9
FRONT PANEL FIRST ROW (CYCLE TIME ADJUSTMENT).....	9
FRONT PANEL SECOND ROW (PRESSURE ADJUSTMENT).....	9
FRONT PANEL THIRD ROW (THERAPY MODE ADJUSTMENT).....	9
FRONT PANEL FOURTH ROW.....	10
INSTALLATION.....	11
UNPACKING.....	11
PUMP AND MATTRESS INSTALLATION.....	11
OPERATION.....	13
PRESSURE ADJUSTMENT.....	14
QUICK DISCONNECT.....	14
TRANSPORT CAP.....	14
CPR FUNCTION.....	15
MAINTENANCE.....	16
CLEANING.....	16
GENERAL MAINTENANCE.....	16
FUSE REPLACEMENT.....	17
AIR FILTER REPLACEMENT.....	17
STORAGE.....	18
SPECIFICATIONS.....	19
ONE (1) YEAR LIMITED WARRANTY.....	20
APPENDIX A: EMC INFORMATION.....	21

**SIMMONS Clinical Care** products manufactured by GF Health Products, Inc. under license from the trademark owner, Dreamwell, Ltd., a subsidiary of Simmons Bedding Company, Atlanta, Georgia. **SIMMONS** is a trademark of Dreamwell, Ltd. a subsidiary of Simmons Bedding Company.

© 2014 Dreamwell, Ltd. All rights reserved.

**Graham-Field** is a registered trademark of GF Health Products, Inc. GF Health Products, Inc. is not responsible for typographical errors. All illustrations, specifications, packaging and warranties contained in this catalog are based on the latest product information available at the time of printing. The most current product information can be found online at [www.grahamfield.com](http://www.grahamfield.com).

# INTRODUCTION

Use this manual for set-up and operation of the SIMMONS™ Clinical Care 760000S Clinical Plus Alternating Pressure / Low Air Loss Mattress System. Read all instructions before using the mattress system. Save this manual for future reference.

## **INTENDED USE OF THIS DEVICE**

The intended use of the SIMMONS™ Clinical Care 760000S Clinical Plus Alternating Pressure / Low Air Loss Mattress System is:

- The treatment of pressure ulcers while optimizing user comfort.
- Pain management as prescribed by a physician.
- As described above, in either a homecare or long term care setting.

## **Contraindication**

**⚠ WARNING: DO NOT use this product in the presence of flammable anesthesia. There is a possible fire hazard when this product is used with certain oxygen delivery equipment.**

**Use nasal cannula, face mask, or 1/2 length oxygen tent to deliver oxygen in the presence of this product.**

**DO NOT use a full length oxygen tent that extends past the top surface of the mattress with this product.**

# IMPORTANT SAFETY PRECAUTIONS

The safety statements presented in this chapter refer to the basic safety information that should be observed by those using the Alternating Pressure / Low Air Loss Mattress System. There are additional safety statements in other chapters or sections, which may be the same as or similar to the following, or specific to the operations.

- ⚠ **DANGER:** Indicates an imminent hazard situation that, if not avoided, will result in death or serious injury.
- ⚠ **WARNING:** Indicates a potential hazard situation or unsafe practice that, if not avoided, could result in death or serious injury.
- ⚠ **CAUTION:** Indicates a potential hazard or unsafe practice that, if not avoided, could result in minor or moderate personal injury.
- ▲ **NOTICE:** Indicates a potential hazard or unsafe practice that, if not avoided, could result in product or property damage.

*Info: Provides application recommendations or other useful information to ensure that you get the most from your product.*

## **DANGER**

### **To reduce the risk of electrocution:**

- ⚠ **DANGER:** Always unplug this product immediately after use.
- ⚠ **DANGER:** Do not use this product while bathing.
- ⚠ **DANGER:** Do not place or store this product where it can fall or be pulled into a tub or sink.
- ⚠ **DANGER:** Do not place this product in or drop into water or other liquid.
- ⚠ **DANGER:** Do not reach for a product that has fallen into water. Unplug it *immediately*.

## **WARNING**

**To reduce the risk of burns, electrocution, fire, or personal injury:**

- ⚠ **WARNING:** Use this product only as intended and described in this manual. Do not use attachments or accessories not recommended by Graham-Field.
- ⚠ **WARNING:** Do not leave this product unattended when plugged in.
- ⚠ **WARNING:** Always use close supervision when this product is used by, on, or near children or those who require close supervision.
- ⚠ **WARNING:** Never operate this product if:
  - a) It has a damaged cord or plug.
  - b) It is not working properly.
  - c) It has been dropped or damaged.
  - d) It has been dropped into water.

Return the product to your Graham-Field authorized distributor.

- ⚠ **WARNING:** Keep the cord away from heated surfaces.
- ⚠ **WARNING:** Never block the air openings of this product or place it on a soft surface, such as a bed or couch, where the openings may be blocked. Keep the air opening free of lint, hair, and other similar particles.
- ⚠ **WARNING:** Never drop or insert any object into any opening or hose.
- ⚠ **WARNING:** Connect this product *only* to a properly grounded power outlet.
- ⚠ **WARNING:** Maximum patient weight capacity for this product is 400 lb (189 kg), **EVENLY DISTRIBUTED.**
- ⚠ **WARNING:** Notice for California Customers- California Proposition 65 **WARNING:** This product contains a chemical known to the State of California to cause cancer and reproductive or developmental harm.

**⚠ WARNING: Patient entrapment with bed side rails may cause injury or death. The bed frame and its components, including the mattress, bed side rails, head and foot board, bedding, and any accessories added to the bed, can all affect the risk of entrapment. Thorough patient assessment and monitoring are necessary to reduce the risk of entrapment, including establishing whether the use of a bed rail is in the best interest of the patient. Read and understand the User Manual before using this equipment. Graham-Field product manuals are available online at [www.grahamfield.com](http://www.grahamfield.com).**







**Visit the FDA's Bed Safety page at [www.fda.gov](http://www.fda.gov) to learn more about the risks of entrapment. It is the responsibility of the facility and provider to be in compliance with these guidelines. Refer to user manuals for beds and rails for additional product safety information.**

**After any adjustment, repair or service, and before use, ensure all attaching hardware is securely tightened. Bed rails with dimensions different than the original equipment specified by the bed manufacturer may not be interchangeable and may result in entrapment or other injury.**

## **NOTICE**

**▲ NOTICE: The pump can be used only with the accompanying mattress. Do not use it for any other purpose.**

## EQUIPMENT SYMBOLS

	Attention! Consult accompanying documents (this manual)	
	“BF” symbol: Indicates that this product is in accordance with the degree of protection against electric shock for type BF equipment	
	Functional earth (for UL only)	
	Class II (for UL only)	
	<b>Disposal of Electrical &amp; Electronic Equipment (WEEE):</b> Do not treat this product as household waste. For more detailed information with regard to returning and recycling this product, please consult your local city office, household waste disposal service, or Graham-Field authorized distributor.	
The system has been tested and successfully approved with the following standards:		
	EN 60601-1, EN 60601-1-2, EN 550011 Class B, IEC61000-3-2, IEC61000-3-3	
For U.S. and Canada only		
E305034 53DG		<b>Medical Equipment: Air Pump</b> with respect to electrical shock, fire and mechanical hazards only in accordance with UL60601-1 and CAN/CSA C22.2 No. 601.1

# PRODUCT DESCRIPTION

## PUMP AND MATTRESS SYSTEM

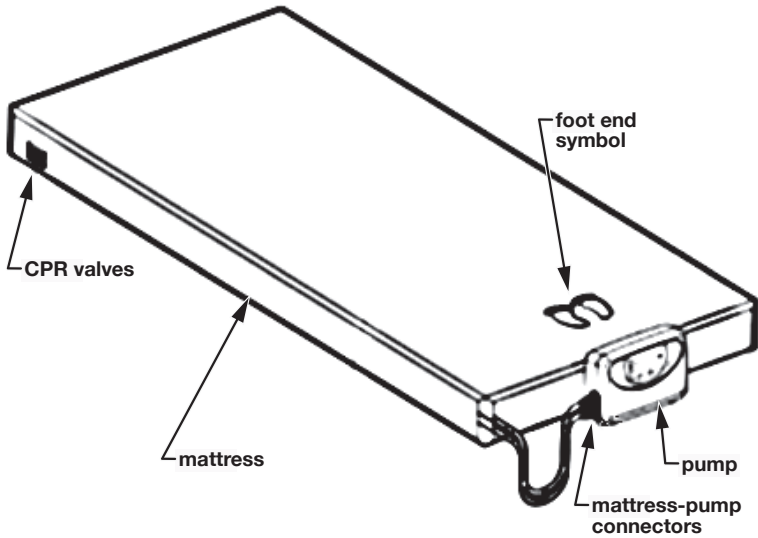

pump and mattress system

## PUMP: FRONT



## PUMP: REAR

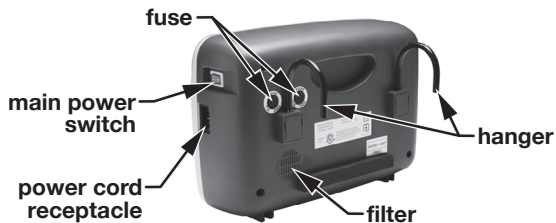



# PUMP: FRONT PANEL

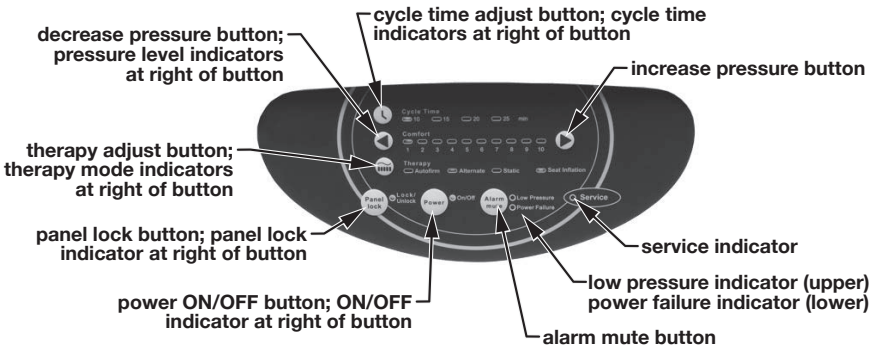

## Front panel first row (cycle time adjustment)

There are four cycle time settings. Press the cycle time adjust button to cycle between the settings. The selected cycle time setting's indicator will illuminate.

## Front panel second row (pressure adjustment)

There are ten pressure (firmness) settings. Press the decrease pressure button at the left end of the row to decrease pressure (softer), and press the increase pressure button at the right end of the row to increase pressure (firmer). The selected pressure level setting's indicator will illuminate.

## Front panel third row (therapy mode adjustment)

There are four therapy mode settings: **Autofirm** (to fill mattress quickly, or to fully inflate mattress during patient ingress/egress for better support), **Alternating Pressure** (every other tube fills, then deflates), **Static** (all tubes remain full), and **Seat Inflation** (when the head is raised to increase pressure under the buttocks). Press the therapy adjust button at the left end of the row to cycle between the settings. The selected therapy mode setting's indicator will illuminate.

## **Front panel fourth row**

**Panel lock button:** The panel lock protects the panel settings from accidental change. Press for two seconds to lock; press for two seconds to unlock. When the panel is locked, the panel lock indicator will illuminate.

**Power button (ON/OFF):** The power button turns power to the mattress ON or OFF. Press to turn ON; press to turn OFF. When power is on, the power (ON/OFF) indicator will illuminate. When power is turned OFF, mattress will slowly deflate. *Info: Main power switch on side of pump must be ON in order for the panel power button to function.*

**Alarm mute button:** The alarm mute button temporarily suspends the LED indicator and buzzer when either the low-pressure alarm or power failure alarm is activated. Should the problem not be resolved within five minutes, the alarm will resume.

**Low pressure indicator:** The low pressure indicator illuminates, and the alarm sounds, when the pressure level is lower than the selected pressure. If the low pressure indicator persistently illuminates inappropriately:

1. Check to ensure all connections are properly and securely connected per installation instructions.
2. Check for any leakage (tubes or connecting hoses). If necessary, contact your Graham-Field authorized distributor to replace any damaged tubes or hoses.
3. If problem persists, contact your Graham-Field authorized distributor.

**Power failure indicator:** The power failure indicator illuminates, and the alarm sounds, when there is a power failure. Depress the alarm mute button to disable both alarm and LED.

**Service indicator:** Mechanical failure, service required; contact your Graham-Field authorized distributor.

# INSTALLATION

## UNPACKING

1. Before unpacking, check for obvious damage to the carton or its contents. If damage is evident, please notify the carrier and your Graham-Field authorized distributor.
2. Remove all loose packing from the carton.
3. Carefully remove all components from the carton.
4. Inspect all components. If damage is evident, please notify the carrier and your Graham-Field authorized distributor.

## PUMP AND MATTRESS INSTALLATION

1. Place the mattress on top of the bed frame; ensure the foot end symbol faces up at foot end as shown at right. Secure mattress to bed with straps.

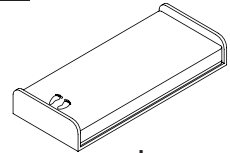

2. Fold open the wire hangers on the back of the pump as shown at right.



3. Either hang the pump on the bed's foot end, as shown at right, or place the pump on a flat surface easily accessible to the caregiver and/or doctor.



- ▲ **NOTICE: Place the device in a position where the caregiver and/or doctor can access it easily.**

4. Connect the mattress-pump air hose quick connector; ensure the connector has clicked securely into place before continuing.



- ▲ **NOTICE:** Ensure that the air hoses are not kinked or tucked under the mattress.
  - ⚠ **WARNING:** Locate all cords so that they will not be stepped on, tripped over, or otherwise subjected to damage or stress.
  - ⚠ **WARNING:** Do not use a household extension cord if the electrical cord does not reach the power outlet. Use of an improper extension cord could result in fire and electric shock. If an extension cord must be used, use a three conductor cord with ground, properly wired, in good electrical condition, and keep it as short as possible.
  - ⚠ **WARNING:** Ensure that the local power voltage is appropriate for the pump unit.
5. Plug the power cord into a properly grounded electrical outlet.

# OPERATION

1. Turn the main power switch to the ON position.



2. Press the front panel power button. The power indicator will illuminate.

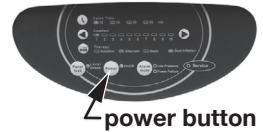

*Info: The mattress system will automatically enter Autofirm mode for the quickest inflation at set-up; initial inflation takes approximately twenty minutes.*

3. The pump will begin delivering air into the mattress. The low pressure indicator (yellow LED) and the Autofirm indicator will illuminate until the mattress is fully inflated.
4. During Autofirm, you can preset the device by pressing the Therapy, Comfort and Cycle Time buttons and selecting the desired settings. The selected indicators will illuminate during Autofirm, and the system will automatically operate your settings immediately after the Autofirm process is complete.
5. When the selected pressure level is reached, the low pressure indicator (yellow LED) and the Autofirm indicator will de-illuminate and the pump will enter alternating mode. If not preset as described in step 4, the mattress can now be adjusted to the desired pressure.
6. Replace all sheets, blankets, and pillows on the bed.

## **PRESSURE ADJUSTMENT**

Generally, a lighter patient will need a lower (softer) setting while a heavier patient will need a higher (firmer) setting, but pressure adjustment must ultimately be based on the patient's *weight distribution*. A short, stocky person may be the same weight as a tall, thin person, but their settings will not be the same. The mattress should be firm enough to support the patient, yet soft enough so the patient will sink down to eliminate pressure points. Initially inflate the mattress to maximum pressure. Then, when the patient lies on the mattress, test the pressure by placing four fingers below the mattress under the patient's buttock area; your fingers should just fit. If the fit is too loose, decrease the setting. If your fingers do not fit well, increase the setting two notches firmer. Wait ten minutes and then check again. You should only have to adjust this setting one time per patient. **Please consult your physician for an appropriate setting.**

## **QUICK DISCONNECT**

Pull the power plug from the wall connector to disconnect the device quickly.

## **TRANSPORT CAP**

In case of power failure or transport: Disconnect the quick connector and cap the mattress with the transport cap to slow deflation.

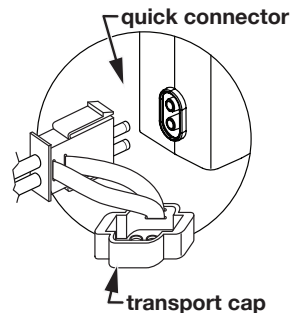

## **CPR FUNCTION**

If CPR must be performed on the patient while the mattress is in use, to immediately deflate the mattress, either:

1. Pull the CPR valves from the mattress in the location of the arrow shown at right, or
2. Disconnect the quick connector from the pump in the location of the arrow shown at right.

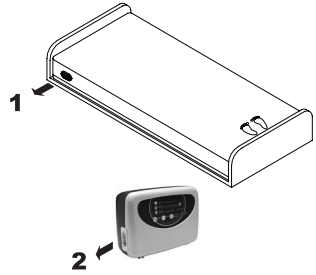

# MAINTENANCE

## CLEANING

Perform the following cleaning procedures before use.

**Pump:** Wipe the pump with a clean, damp cloth and mild detergent, and keep it away from dust. Air dry.

▲ **NOTICE: Do not use phenolic products or corrosive or powdered cleansers to clean the pump.**

▲ **NOTICE: Do not immerse or soak the pump.**

**Mattress:** Wipe the mattress unit with a clean, damp cloth and mild detergent. The mattress may also be cleaned using a 10% solution of sodium hypochlorite (bleach) diluted in water. Air dry all parts thoroughly before use.

▲ **NOTICE: Do not use phenolic products to clean the mattress.**

▲ **NOTICE: After cleaning, air dry the mattress without direct exposure to sunlight.**

## GENERAL MAINTENANCE

1. Check main power cord for abrasion or excessive wear.
2. Check mattress cover for signs of wear or damage. Ensure mattress cover and tubes are connected correctly.
3. Check airflow from the air hose connector. The airflow should alternate between each connector every half-cycle time if it's in alternating mode.
4. Check the air hoses for any kink or break. For replacement, please contact your Graham-Field authorized distributor.



## **Fuse replacement**

*tool needed: small screwdriver*

1. If you suspect a blown fuse, disconnect the plug from the wall outlet immediately.
2. Use a small screwdriver to remove the cover of the fuse holder (fuse locations are shown in picture at right).
3. Insert a new fuse of the correct rating (T1A/250V, VDE approved).
4. Replace the fuse holder cover. Ensure that fuse holder cover is securely installed.



## **Air filter replacement**

*tool needed: small screwdriver*

1. Use a small screwdriver to remove the air filter plate located at rear of pump (filter location is shown in picture at right).
2. Remove the filter. The filter is reusable, if not torn, and can be washed gently with a mild detergent and water. Dry the filter before use.
3. Replace the filter and cover. Ensure that filter cover is securely installed. Replace the air filter regularly if it is gray, torn, or the environment is dirty.



## **STORAGE**

1. Lay the mattress out flat and upside down.
  2. Roll from the head end toward the foot end.
  3. Stretch the foot-end strap around the rolled mattress to prevent unrolling.
  4. Store mattress and pump in a dust-free environment with no exposure to direct sunlight.
- ▲ **NOTICE: Do not fold, crease or stack the mattress.**

## SPECIFICATIONS

<b>Pump</b>		<b>Specification</b>
Power Supply		120V System: AC 120V 60 Hz Info: see rating label on product
Fuse Rating		T1A, 250V
Cycle time		10, 15, 20 or 25 minutes
Air input		>8 LPM
Dimensions (L x W x H)		11.4" x 7.9" x 4.6" (29.1 x 20 x 11.7 cm)
Weight		5 lb (2.2 kg)
Environment	Temperature	Operation: 50°F to 104°F (10°C to 40°C) Storage: 5°F to 122°F ( -15°C to 50°C) Shipping: 5°F to 158°F ( -15°C to 70°C)
	Humidity	Operation: 10% to 90% non-condensing Storage: 10% to 90% non-condensing Shipping: 10% to 90% non-condensing
Classification		Class II, Type BF, IPX0 Applied Part: Air Mattress Not suitable for use in the presence of a flammable anesthetic mixture (No AP or APG protection)

<b>Mattress</b>		<b>Specification</b>
Model		8" mattress
Dimensions (L x W x H)		78.7" x 35.4" x 8" (200 x 90 x 20.3 cm)
Weight		16.5 lb (7.5 kg)

# ONE (1) YEAR LIMITED WARRANTY

## SCOPE OF WARRANTY

GF Health Products, Inc. ("GF") warrants to the original purchaser only that it will replace or repair components, at GF's sole discretion, that are defective in material or workmanship under normal use and service. All warranties are conditioned upon the proper use of the products strictly in accordance with good commercial practice and applicable GF instructions and manuals, including proper use and maintenance. To the extent that a component is warranted by a third party, GF conveys all of its rights under that warranty to the original purchaser, to the extent permitted. This limited warranty shall only apply to defects that are reported to GF's customer service team within the applicable warranty period and which, upon examination by GF or its authorized representative, prove to be a warranty item. This limited warranty is not transferable.

The warranted components and time period are set forth below:

SIMMONS™ Clinical Care 760000S Clinical Plus

Alternating Pressure / Low Air Loss Mattress System: ..... one year

The applicable warranty period shall commence from date of shipment to the original customer, unless there is an expiration date on the component in which case the warranty shall expire on the earlier of warranty period or the expiration date.

## OBTAINING WARRANTY SERVICE

A GF Customer Service Representative must authorize warranty service. Please contact the GF Customer Service department by calling 678-291-3207, sending a fax request to 770-368-2386 or by e-mailing a request to [cs@grahamfield.com](mailto:cs@grahamfield.com). Specific directions will be provided by the Customer Service Representative. Failure to abide by the specific directions will result in denial of the warranty claim.

## EXCLUSIONS

The warranty does not cover and GF shall not be liable for the following:

- 1) Defects, damage, or other conditions caused, in whole or in part, by misuse, abuse, negligence, alteration, accident, freight damage, tampering or failure to seek and obtain repair or replacement in a timely manner;
- 2) Products which are not installed, used, or properly cleaned and maintained as required in the official manual for the applicable product;
- 3) Products considered to be of a non-durable nature including, but not limited to: casters, filters, fuses, gaskets, lubricants, and charts;
- 4) Accessories or parts not provided by GF;
- 5) Charges by anyone for adjustments, repairs, replacement parts, installation or other work performed upon or in connection with such products which are not expressly authorized in writing, in advance, by GF;
- 6) Any labor or shipping charges incurred in the replacement part installation or repair;
- 7) Costs and expenses of regular maintenance and cleaning; and
- 8) Representations and warranties made by any person or entity other than GF.

## ENTIRE WARRANTY, EXCLUSIVE REMEDY AND CONSEQUENTIAL DAMAGES DISCLAIMER

THIS WARRANTY IS GF'S ONLY WARRANTY AND IS IN LIEU OF ALL OTHER WARRANTIES, EXPRESS OR IMPLIED. GF MAKES NO IMPLIED WARRANTIES OF ANY KIND INCLUDING ANY IMPLIED WARRANTIES OF MERCHANTABILITY OR FITNESS FOR A PARTICULAR PURPOSE.

IF ANY MODEL OR SAMPLE WAS SHOWN TO THE CUSTOMER, SUCH MODEL OR SAMPLE WAS USED MERELY TO ILLUSTRATE THE GENERAL TYPE AND QUALITY OF THE PRODUCT AND NOT TO REPRESENT THAT THE PRODUCT WOULD NECESSARILY CONFORM TO THE MODEL OR SAMPLE IN ALL RESPECTS.

THIS WARRANTY IS LIMITED TO THE REPAIR OR REPLACEMENT OF THE DEFECTIVE PARTS. GF SHALL NOT BE LIABLE FOR AND HEREBY DISCLAIMS ANY DIRECT, SPECIAL, INDIRECT, INCIDENTAL, EXEMPLARY OR CONSEQUENTIAL DAMAGES, INCLUDING, BUT NOT LIMITED TO: DAMAGES FOR LOSS OF PROFITS OR INCOME, LOSS OF USE, DOWNTIME, COVER, OR EMPLOYEE OR INDEPENDENT CONTRACTOR WAGES, PAYMENTS AND BENEFITS.

The warranties contained herein contain all the representations and warranties with respect to the subject matter of this document, and supersede all prior negotiations, agreements and understandings with respect thereto. The recipient of this document hereby acknowledges and represents that it has not relied on any representation, assertion, guarantee, warranty, collateral contract or other assurance, except those set out in this document.

For additional information on this product or this warranty, please contact a GF Customer Service Representative.

## NOTES:

- 1) Additional terms and conditions may apply.
- 2) Freight claims must be noted on the Bill of Lading and must be made with immediacy. The ICC regulations govern specific requirements for freight claims. Failure to abide by those regulations may result in a denial of the freight claim. GF will assist you in filing the freight claim.
- 3) Claims for any short shipment must be made within thirty (30) days of the invoice date.

GF Health Products, Inc.  
2935 Northeast Parkway  
Atlanta, GA 30360  
Tel 770-368-4700  
Fax 770-368-2386  
[www.grahamfield.com](http://www.grahamfield.com)

# APPENDIX A: EMC INFORMATION

## Guidance and Manufacturer's Declaration- Electromagnetic Emissions:

This device is intended for use in the electromagnetic environment specified below. The user of this device should make sure it is used in such an environment.

Emissions Test	Compliance	Electromagnetic Environment-Guidance
Harmonic emissions IEC61000-3-2	Class A	The device is suitable for use in all establishments, including domestic establishments and those directly connected to the public low-voltage power supply network.
Voltage fluctuations / Flicker emissions IEC61000-3-3	Complies	

## Guidance and Manufacturer's Declaration- Electromagnetic Immunity:

This device is intended for use in the electromagnetic environment specified below. The user of this device should make sure it is used in such an environment.

Immunity Test	IEC60601 Test Level	Compliance	Electromagnetic Environment-Guidance
Electrostatic Discharge(ESD) IEC61000-4-2	±6kV contact ±8kV air	±6kV contact ±8kV air	Floors should be wood, concrete or ceramic tile. If floors are covered with synthetic material, the relative humidity should be at least 30 %.
Electrical fast transient/ burst IEC61000-4-4	±2kV for power supply line ±1kV for input/out line	±2kV for power supply line ±1kV for input/out line	Mains power quality should be that of atypical commercial or hospital environment
Surge IEC61000-4-5	±1kV for differential mode ±2kV for common mode	±1kV for differential mode ±2kV for common mode	Mains power quality should be that of atypical commercial or hospital environment.
Voltage dips, short interruptions and voltage variations on power supply input lines IEC61000-4-11	<5 % UT(>95 % dip in UT)for 0,5 cycle 40 % UT(60 % dip in UT)for 5 cycles 70 % UT(30 % dip in UT)for 25 cycles <5 % UT(>95 % dip in UT)for 5 sec	<5 % UT(>95 % dip in UT) for 0,5 cycle 40 % UT(60 % dip in UT) for 5 cycles 70 % UT(30 % dip in UT) for 25 cycles <5 % UT(>95 % dip in UT) for 5 sec	Mains power quality should be that of atypical commercial or hospital environment. If the user of this device requires continued operation during power mains interruptions, it is recommended that the device be powered from an uninterruptible power supply or a battery.
Power frequency (50/60Hz) magnetic field IEC61000-4-8	3 A/m	3 A/m	Power frequency magnetic fields should be at levels characteristic of atypical location in a typical commercial or hospital environment.

NOTE:  $U_T$  is the a.c. mains voltage prior to the application of the test level

**Guidance and Manufacturer's Declaration- Electromagnetic Immunity:**

This device is intended for use in the electromagnetic environment specified below. The user of this device should make sure it is used in such an environment.

Immunity Test	IEC60601 Test Level	Compliance	Electromagnetic Environment-Guidance
Conducted RF IEC 61000-4-6	3Vrms150 kHz to 80 MHz outside ISM bands <sup>a</sup>	3Vrms	<p>Portable and mobile RF communications equipment should be used no closer to any part of this device, including cables, than the recommended separation distance calculated from the equation applicable to the frequency of the transmitter.</p> <p>Recommended separation distance  <math>d = 1.2\sqrt{P}</math> 150kHz to 80MHz</p>
Radiated RF IEC 61000-4-3	3 V/m 80 MHz to 2.5 GHz	3V/m	<p><math>d = 1.2\sqrt{P}</math> 150kHz to 80MHz  <math>d = 2.3\sqrt{P}</math> 80 MHz to 2.5G MHz</p> <p>Where P is the maximum output power rating of the transmitter in watts (W) according to the transmitter manufacturer and d is the recommended separation distance in meters (m).<sup>b</sup></p> <p>Field strengths from fixed RF transmitters, as determined by an electromagnetic site survey<sup>c</sup>, should be less than the compliance level in each frequency range<sup>d</sup>.</p> <p>Interference may occur in the vicinity of equipment marked with the following symbol:</p> 
<p>NOTE 1 At 80 MHz and 800 MHz, the higher frequency range applies.</p> <p>NOTE 2 These guidelines may not apply in all situations. Electromagnetic propagation is affected by absorption and reflection from structures, objects and people.</p>			

- a The ISM (industrial, scientific and medical) bands between 150 kHz and 80 MHz are 6,765 MHz to 6,795 MHz; 13,553 MHz to 13,567 MHz; 26,957 MHz to 27,283 MHz; and 40,66 MHz to 40,70 MHz.
- b The compliance levels in the ISM frequency bands between 150 kHz and 80 MHz and in the frequency range 80 MHz to 2,5 GHz are intended to decrease the likelihood that mobile/portable communications equipment could cause interference if it is inadvertently brought into patient areas. For this reason, an additional factor of 10/3 is used in calculating the recommended separation distance for transmitters in these frequency ranges.
- c Field strengths from fixed transmitters, such as base stations for radio (cellular/cordless) telephones and land mobile radios, amateur radio, AM and FM radio broadcast and TV broadcast cannot be predicted theoretically with accuracy. To assess the electromagnetic environment due to fixed RF transmitters, an electromagnetic site survey should be considered. If the measured field strength in the location in which the device is used exceeds the applicable RF compliance level above, the device should be observed to verify normal operation. If abnormal performance is observed, additional measures may be necessary, such as reorienting or relocating the device.
- d Over the frequency range 150 kHz to 80 MHz, field strengths should be less than 3 V/m.

### Recommended separation distances between portable and mobile RF communications equipment and this device

This device is intended for use in an electromagnetic environment in which radiated RF disturbances are controlled. The customer or the user of this device can help prevent electromagnetic interference by maintaining a minimum distance between portable and mobile RF communications equipment (transmitters) and this device as recommended below, according to the maximum output power of the communications equipment

Rated maximum output power of transmitter W	Separation distance according to frequency of transmitter m		
	150 kHz to 80 MHz $d = 1.2\sqrt{P}$	80 MHz to 800 MHz $d = 1.2\sqrt{P}$	800 MHz to 2,5 GHz $d = 2.3\sqrt{P}$
0.01	0.12	0.12	0.23
0.1	0.38	0.38	0.73
1	1.2	1.2	2.3
10	3.8	3.8	7.3
100	12	12	23

For transmitters rated at a maximum output power not listed above, the recommended separation distance  $d$  in meters (m) can be estimated using the equation applicable to the frequency of the transmitter, where  $P$  is the maximum output power rating of the transmitter in watts (W) according to the transmitter manufacturer.

**Note 1:** At 80 MHz and 800 MHz, the separation distance for the higher frequency range applies.

**Note 2:** These guidelines may not apply in all situations. Electromagnetic propagation is affected by absorption and reflection from structures, objects, and people.

**GF Health Products, Inc.  
2935 Northeast Parkway  
Atlanta, Georgia 30360**

**telephone: 770-368-4700  
fax: 770-368-2386**



**GRAHAM-FIELD<sup>®</sup>**

**[www.grahamfield.com](http://www.grahamfield.com)**

**© 2013 GF Health Products, Inc.**