

Liebert XDK™ Rack Enclosure With Integrated Water-Based Cooling

User Manual—17kW

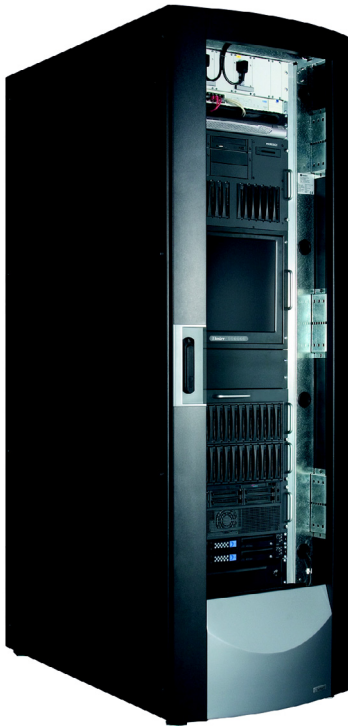

For More Information:
(866) 787-3271
Sales@PTSdcs.com



IMPORTANT SAFETY INSTRUCTIONS

SAVE THESE INSTRUCTIONS

Liebert engineers will provide comprehensive support on how to install the XDK.

Extensive material, function and quality checks ensure that you fully benefit from product functions and a long service life. Nevertheless, this product can produce hazards if it is used incorrectly by untrained personnel or is not used for the correct purpose.

Read these operating instructions carefully before commissioning the XDK.

The electrical equipment complies with the applicable VDE and accident prevention regulations. Hazardous voltages (higher than 50 VAC or higher than 100 VDC) are present:

- inside the electric box in the unit's housing
- behind the fan cover on the outside of the rear door

Shut down the unit immediately if there are problems with electrical input or cold water supply.



WARNING

Risk of electric shock. Can cause injury or death.

Disconnect all local and remote electric power supplies before working within.

Only qualified personnel may perform repair, maintenance, and cleaning operations.



NOTE

Cleaning and servicing must be performed by qualified personnel. To ensure that the unit remains safe to use and has a long service life, observe the maintenance and cleaning intervals.

Operate the XDK correctly within the stipulated ratings and with approved equipment.

During all work on and with the unit, observe:

- All applicable regulations (e. g., VDE regulations and other applicable national regulations)
- All applicable accident prevention instructions (BGV)
- All applicable laws on environmental protection

Operate the XDK only if it is in proper working condition. If a malfunction or fault occurs, you must shut down the unit immediately and notify the responsible facility official or employee.

Resume operating the unit only after the malfunction or fault has been rectified and the XDK's function has been re-established.



CAUTION

Risk of contact with hot surfaces. Can cause burn injury.

Fans, power supplies, PC boards, and other components become extremely hot during unit operation. Allow sufficient time for them to cool before working within the unit.

Use extreme caution and wear protective gloves and arm protection when working on or near hot components.

TABLE OF CONTENTS

IMPORTANT SAFETY INSTRUCTIONS	INSIDE FRONT COVER
1.0 INTRODUCTION	1
2.0 OPERATING CONDITIONS	2
2.1 Proper Application	2
3.0 DESCRIPTION	3
3.1 General function	3
3.2 Principle of Cooling Operation	4
3.2.1 Data Overview—XDK	5
3.3 Control	6
3.4 Automatic Door Opening	6
3.4.1 Function	7
3.4.2 Initial Commissioning:	7
3.4.3 Manual Closing	8
3.4.4 Manual Opening	8
4.0 EQUIPMENT INSPECTION, HANDLING AND STORAGE	9
4.1 Packaging Material	9
4.2 Handling	9
4.3 Storage	10
4.4 Returning the Unit in Case of Damage	10
5.0 INSTALLATION AND COMMISSIONING	11
5.1 Preparation for Installation	11
5.2 Positioning the XDK	11
5.2.1 Remove Recirculation Air Duct Transport Lock	11
5.3 Water Connection	12
5.3.1 Preparing Heat Exchanger for Initial Commissioning	12
5.4 Condensed Water Connection	14
5.5 Electrical Connection	15
5.6 Sealing the Cabinet	15
6.0 SERVICING AND MAINTENANCE	16
6.1 General Inspection on Fans—Annual	16
6.1.1 Fan Replacement	16
6.2 Inspect the Heat Exchanger—Annual	17
6.3 Replacing the Heat Exchanger	18
7.0 DISMANTLING AND DISPOSAL	19
8.0 WATER PURITY REQUIREMENTS	20
8.1 Unit Installation Checklist	21
8.2 Commissioning Certificate	22

FIGURES

Figure 1	Cooling airflow, top view	3
Figure 2	Cooling airflow, side view	4
Figure 3	XDK door and automatic opening mechanism	6
Figure 4	Door locking mechanisms, opening switch	7
Figure 5	Remove the transport lock screws	11
Figure 6	Heat exchanger access	12
Figure 7	Control valve	12
Figure 8	Heat exchanger	13
Figure 9	Heat exchanger connection.	13
Figure 10	Bottom plate with cutouts	14
Figure 11	Replacing a fan	16
Figure 12	Heat exchanger replacement	18

TABLES

Table 1	General operating data	2
Table 2	Technical data	5
Table 3	XDK general data	5
Table 4	Prevalent impurities and removal methods	20
Table 5	Suggested hydrologic levels	20
Table 6	XDK – Commissioning certificate	22
Table 7	Nominal values at setup site	22
Table 8	Type of cabinet	23
Table 9	Control of status	23
Table 10	Cold water facility on site	24
Table 11	Electrical data / documents	24
Table 12	Function check	24

1.0 INTRODUCTION

The Liebert XDK provides the dissipation of heat loads up to 17kW.

The server rack is closed to the installation area, that means no heat load will dissipate to the environment. (see also chapter 2.) The cooling is provided by a closed cooling system via an air-to-water heat exchanger. The cooling capacity adapts to the heat load.

19" (483mm) rails are designed for components as well as rails and shelves.

Cable entry is possible from the bottom and from the top.

2.0 OPERATING CONDITIONS

2.1 Proper Application

The XDK is a water-cooled enclosure and is intended for removing heat from electronic equipment inside the cabinet. The cooling system in the cabinet is thermally independent of the room air. Water is used to cool equipment installed in the XDK. No additional cooling of the server room is required.



NOTE

Under certain conditions, a small amount of heat, (approximately 0.5kW), can escape into the room.



CAUTION

Risk of improper operation. Can cause equipment damage. For reliable function of the XDK, cold water must be available in the correct amount, and at the correct temperature and pressure. Observe water quality specified in VGB-R 455 P. (see **8.0 - Water Purity Requirements**).

Table 1 General operating data

Ambient temperature	50°F to 95°F (10°C to 35°C) (other temperatures upon request)
Absolute humidity in the installation location	8g H ₂ O/ kg air maximum
Water temperature, supply	54°F (12°C); other temperatures upon request
Water temperature, return	64°F (18°C); other temperatures upon request
Water connection	from below
Condensed water connection	from below
Nominal voltage	200V to 264V (50Hz and 60 Hz)
Maximum operating pressure	145 PSI (10 bar)

3.0 DESCRIPTION

3.1 General function

The modular design facilitates the installation of 19-inch-wide equipment of varying depth.

Heat produced by equipment in the cabinet, such as servers, is removed by the cold water system integrated into the server cabinet. The cooling system is isolated from the server area, protecting the sensitive equipment from water damage.

The cooling system comprises a high-performance air/water heat exchanger, fans with fan control unit, fan-speed according to heat load.

The air circuit is closed such that no heat is emitted to the environment.



CAUTION

Risk of improper operation. Can cause equipment damage.

The XDK works only if cold server feed air and heated server outlet air are fully separated. Height units not in use must be sealed with blanking panels.

Figure 1 Cooling airflow, top view

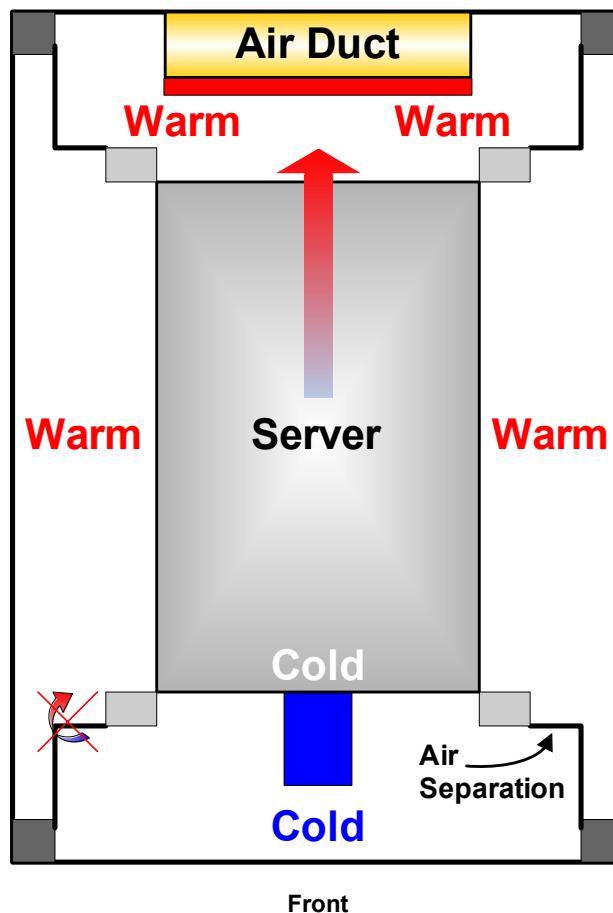

3.2 Principle of Cooling Operation

Figure 2 Cooling airflow, side view

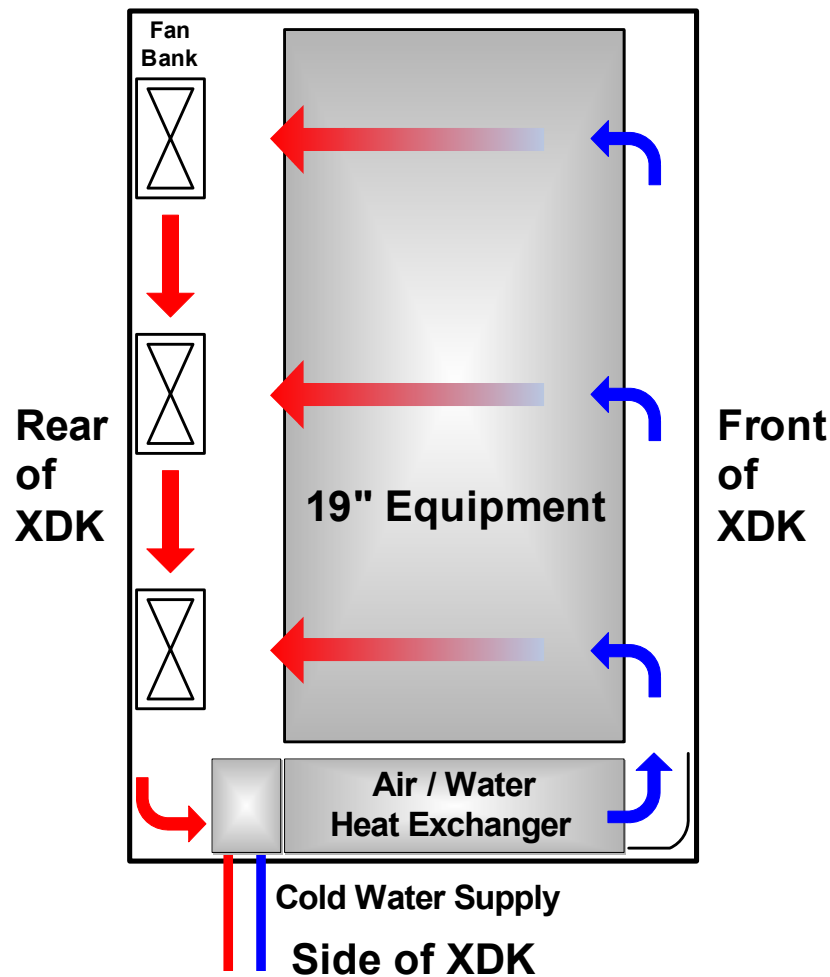

Air that has been heated by the servers to 95°F (35°C), for example, is circulated to a specially designed air/water heat exchanger by high-performance fans. The heated air is cooled to 68-77°F (20-25°C) and fed to the front of the server.

The server fans can draw in the air and feed it over internal components.

Cold water is provided by a separate Liebert XD Pumping unit.

A condensate tray with a 5/8" outlet is below the heat exchanger.



NOTE

If the rear door (with fans) is opened, the front door must be opened. If the front door is opened, it is not necessary to open the rear door.

Table 2 Technical data

Housing material	Aluminium sheet, sheet steel, galvanized and coated
Operating Temperature range	50°F to 95°F (10°C to 35°C)
Abs. atmospheric humidity	8g / kg maximum
Temperature difference across server	approx. 15K
Noise level	55 dB(A) sound pressure at a distance of 3 ft. (1m)
Useful load	2204 lb (1000kg)
Cold Water	
Cooling capacity	17kW
Supply temperature	54°F (12°C) (other temperatures upon consultation)
Return temperature	64°F to 72°F (18°C to 22°C) (other temperatures upon consultation)
Max. operating pressure	145 PSI (10 bar)
Water supply connection	1"

3.2.1 Data Overview—XDK

Table 3 XDK general data

Nominal Cooling Capacity	17kW @ 54°F (12°C) EFT
Height, in (mm)	86.6 (2200)
Width, in (mm)	31.5 (800)
Depth, in (mm)	47 (1200)
Usable Height for Electronic Equipment	40 U
Maximum Electronic Equipment Depth, in (mm)	29 (740)
Electronic Equipment Air Temperature, In/Out, °F (°C)	68/98 (20/37)
Weight, Empty, lb (kg)	683 (310)
Maximum Weight, Filled	2,800 (1310)
Maximum Operating Water Pressure, psi (bar)	145 (10)
Water Flow Rate, GPM (m³/h)	10.7 (2.44)
Water Pressure Drop, psi (bar)	10 (0.7)
Water Connections, in	1
Maximum Air Flow, CFM (m³/h)	1800 (3,100)
Sound Pressure Level	55 dB(A) at 3 ft (1m)
Input Voltage	200-264 V, 1 ph, 50/60 Hz
Maximum Power Draw	1400W
Options	Leveling Feet or Casters

3.3 Control

The server cabinet temperature is controlled by the fan control board

A temperature sensor continuously measures the temperature of the server cabinet (server feed air). The air circulation flow rate is controlled by the fan speed according to the current thermal load.

At temperatures lower than 70°F (21°C) fans rotate at 75% of maximum speed.

Between 68°F and 73°F (20 and 23°C), speed increases proportionally to the temperature up to 96% of maximum speed.

The failure of the temperature sensor set the fans to maximum speed.

The water flow rate is controlled by a three-way valve depending on thermal load. In case of failure, the valve opens and the all the chilled water flows through the heat exchanger.

From 61°F to 66°F (16°C to 19°C), the three-way valve controls the water flow rate from 0% to 100% of the nominal flow rate.

The programming of the control is factory-set and protected with a password.

The failure of the temperature sensor or one of the fans will set off an alarm using a potential free contact.

The outgoing alarms with potential free contact are:

- sensor error
- fan malfunction
- high-temperature / low-temperature

The fans are automatically shut down if the server cabinet rear door is opened.

3.4 Automatic Door Opening

Figure 3 XDK door and automatic opening mechanism

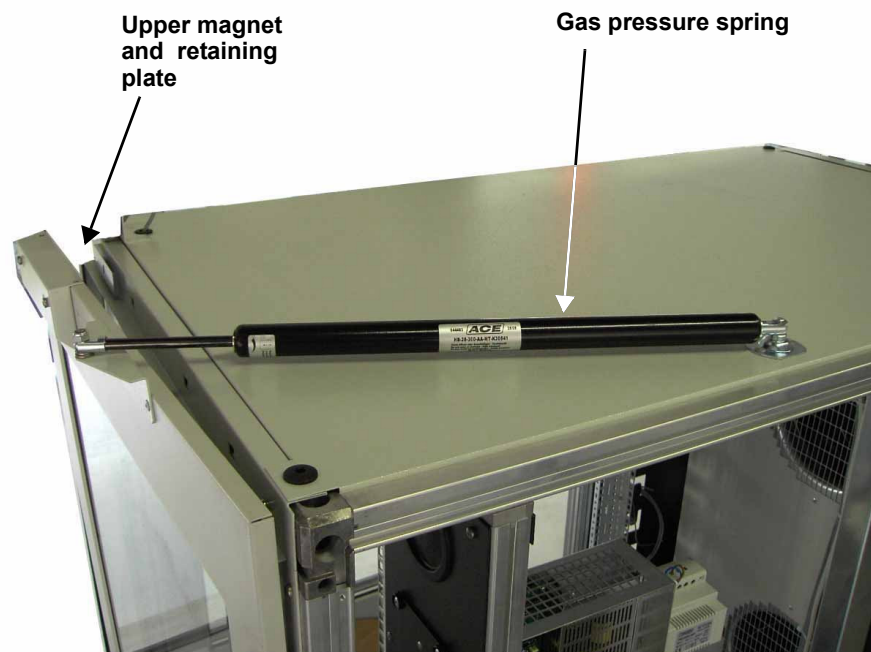

3.4.1 Function

Front and rear door are kept closed with two electromagnets. The door will be pushed open smoothly by a gas pressure spring if power to the electromagnets fails.

If the doors are opened, the thermal load can escape into the room, preventing the servers from overheating.

The inflow of air with water droplets can also be prevented (Door opening due to humidity alarm). When the rear door is opened, the fans shut down automatically.

Figure 4 Door locking mechanisms, opening switch

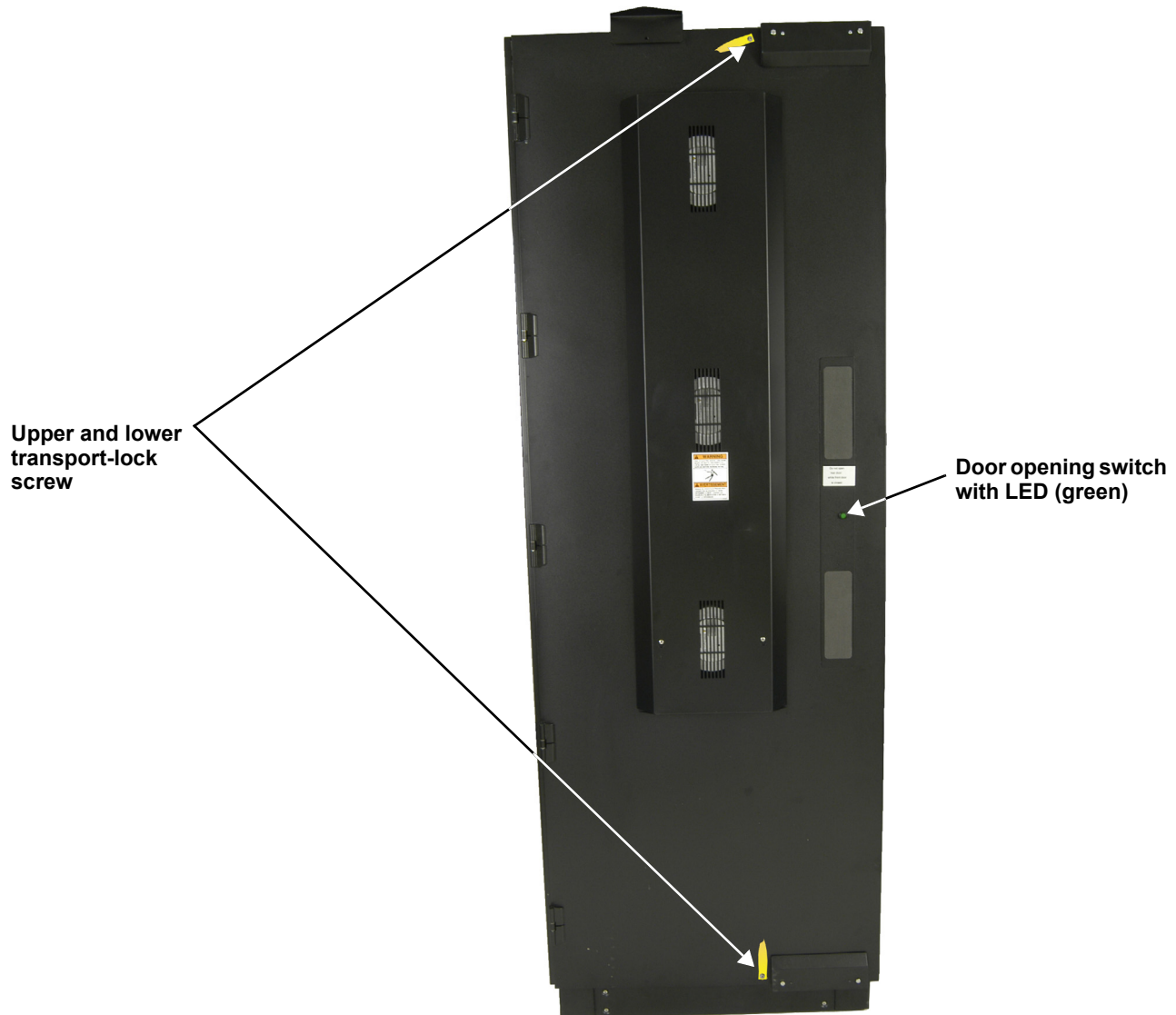

3.4.2 Initial Commissioning:

- ___ 1. Loosen the upper and lower transport lock screw
- ___ 2. Connect inlet power to the power supply (See 3.4.3 - Manual Closing.)



NOTE

If the power supply fails during initial commissioning, the front door opens automatically. If the transport lock screws are reinstalled, both transport lock screws must be reinserted or the door could be damaged

3.4.3 Manual Closing

1. Press LED switch for electromagnet activation
2. The LED lights up
3. Push door evenly shut. Both magnetic locks must latch.

3.4.4 Manual Opening

1. Press LED switch - green LED doesn't light
2. Rack door opens itself

4.0 EQUIPMENT INSPECTION, HANDLING AND STORAGE

Upon arrival of the unit, and before unpacking, verify that the labeled equipment matches the bill of lading. Inspect all items for damage, either visible or concealed. Damage should be immediately reported to the carrier and a damage claim filed with a copy sent to your local sales representative.

4.1 Packaging Material

All material used to package this unit is recyclable. Please save for future use or dispose of the material appropriately.

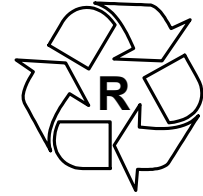

SAFETY INFORMATION



WARNING

Risk of top-heavy unit falling over. Improper handling can cause equipment damage, injury or death! Read all of the following instructions before attempting to move, lift, remove packaging from or preparing unit for installation.



WARNING

Risk of sharp edges, splinters and exposed fasteners. Can cause personal injury. Only properly trained personnel wearing appropriate safety headgear, gloves, shoes and glasses should attempt to move, lift, remove packaging from or prepare unit for installation.



CAUTION

Risk of overhead interference. Can cause unit and/or structure damage. Refer to the installation plans prior to moving the unit to verify clearances.



CAUTION

Risk of damage from fork lift! Improper handling with the forklift can cause exterior and/or underside damage! Keep tines of the fork lift level and at a height suitable to fit below the skid.

4.2 Handling

When possible, transport the unit using a forklift or pallet jack. Otherwise use a crane with belts or cables.

- When using a forklift or pallet jack, make sure the forks (if adjustable) are spread to the widest allowable distance that will fit under the skid.
- Ensure that the fork length is suitable for the unit length.
- When using a forklift while moving the packaged XDK, do not lift it higher than 6" (152mm).
- If circumstances require the XDK to be lifted higher than 6" (152mm), great care must be exercised. Personnel not involved in moving the unit must be at least 20' (5m) from the lift point of the unit.
- Belts or cables must be used when the XDK is moved with a crane.
- The XDK's net weight is 749 lb. (340 kg).
- Avoid twisting the housing or other damage during handling.
- Ensure that the XDK's doors are closed prior to lifting.
- Do not stand under an XDK while it is suspended.
- Hooks used to attach to the unit must be of appropriate tensile strength.
- The XDK must not be lifted at an angle.

4.3 Storage

- If the XDK's packaging has been removed, cover it with tarpaulins to protect against particulates, such as sand and dust, and from moisture.
- Keep storage temperature between -22°F and 104°F (-30°C and +40°C).
- The heat exchanger must be completely drained to prevent the risk of freezing damage.
- When stored for more than 12 months, turn fans by hand to check the fan bearings prior to installation.

4.4 Returning the Unit in Case of Damage

If the XDK is not returned in its original packaging, the packaging used for return must comply with the following:

- There must be at least 1-3/16" (30mm) space between the unit and the packaging.
- Footprint of the skid shall extend at least 2-1/2" (64mm) from the perimeter of the unit.
- The XDK must be attached to the skid using original metal brackets or steel banding.
If steel banding is used to hold unit to the skid, place reinforced protective material between the banding and the XDK.
- Ensure proper shipping information is affixed to the exterior of the packaging.

5.0 INSTALLATION AND COMMISSIONING

5.1 Preparation for Installation



CAUTION

Risk of improper installation. Can cause equipment damage.

Before installing the unit, a number of points must be checked for safety and to ensure the correct function of the server cabinet. Take care when performing these checks to ensure that the unit functions correctly.



CAUTION

Risk of improper installation. Can cause equipment damage.

The XDK must be installed on a level surface. For this reason, check the horizontal alignment with a spirit level prior to starting installation. The floor must be able to support a rack load of 307 lb/ft² (1500 kg/m²) (with installed equipment per XDK).

To achieve good air circulation, ensure that there is no packaging material or other equipment that could hinder or prevent air circulation in the area of the equipment, in the area of the heat exchanger, in the air inlet or in the air outlet.

5.2 Positioning the XDK

After positioning, the XDK's feet must be adjusted to make the cabinet vertical. When positioned the doors must close easily.

5.2.1 Remove Recirculation Air Duct Transport Lock

The Liebert XDK is shipped without the gas pressure springs for the front and rear automatic door openers installed. The springs should be installed according to separate instructions before the Liebert XDK is connected and turned on.

After positioning, remove the transport lock screws at the sides of the recirculation air duct (see **Figure 5**).

The recirculation air duct may be pulled out to remove items that fall into the heat exchanger tray.

Figure 5 Remove the transport lock screws

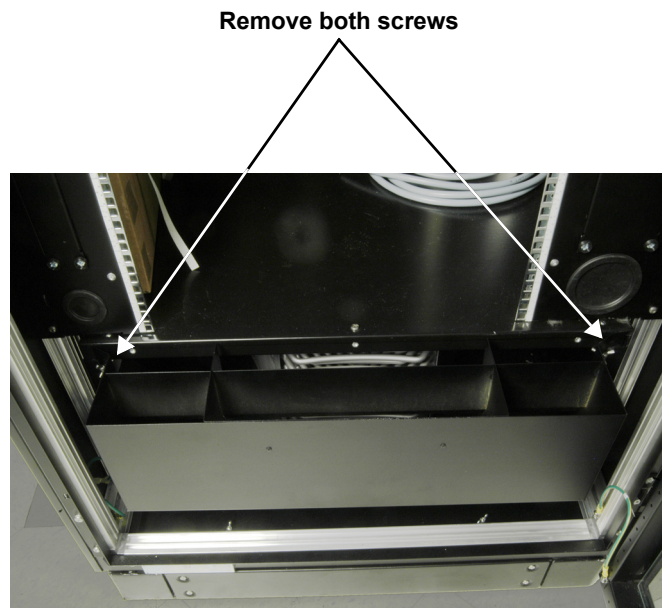

5.3 Water Connection

The heat exchanger can be pulled out for servicing

Water pipes should be connected so that the heat exchanger can be pulled out when the connection is undone. If the heat exchanger is connected to the water circuit using threaded fittings, the pipe fitting must be supported on tightening.

Before commissioning the server cabinet, the pipe connections should be checked for leaks according to local codes.

5.3.1 Preparing Heat Exchanger for Initial Commissioning

Check the mechanical installation and the supply pipe connection.

Figure 6 Heat exchanger access

Remove this air duct for bleeding, draining the heat exchanger and checking the valve

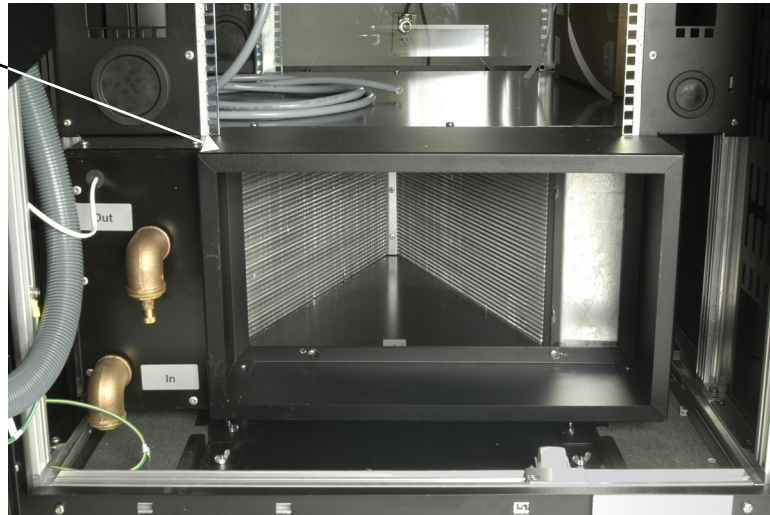

1. Carefully bleed heat exchanger when filling the system.
2. Open the air bleed valve until the water coming out has no bubbles.
3. Close this valve after bleeding.

Figure 7 Control valve

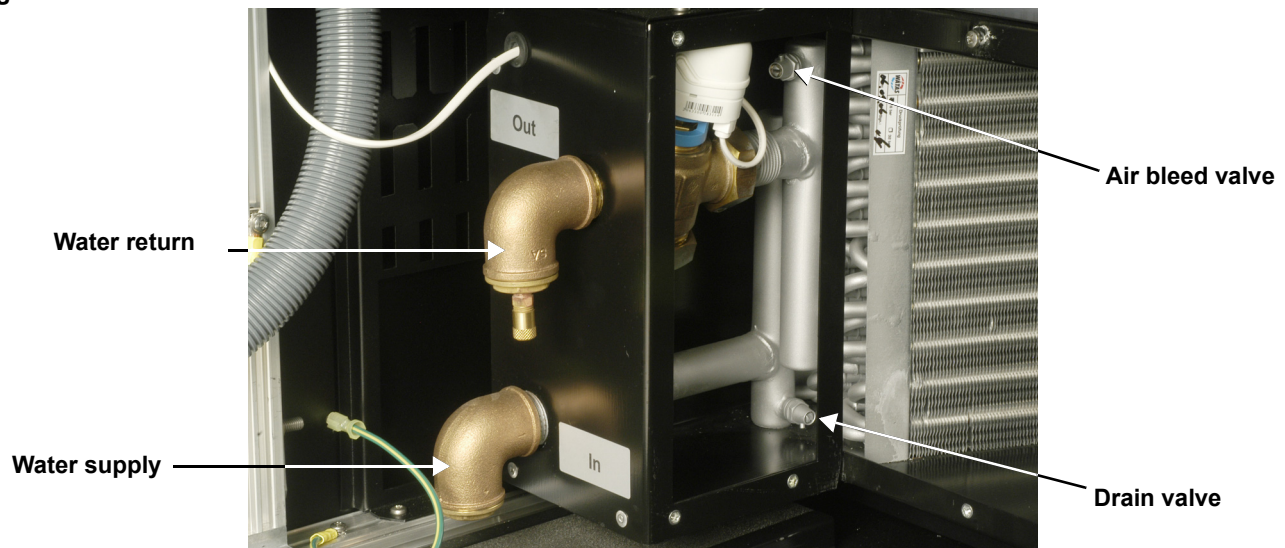

4. If necessary, retighten threaded fittings.
5. After an extended period without use, and particularly in case of risk of freezing temperatures, the heat exchanger and the supply pipe must be drained of all fluid.
6. Drain completely by blowing out with compressed air and remove all bleed and drain plugs.

Figure 8 Heat exchanger

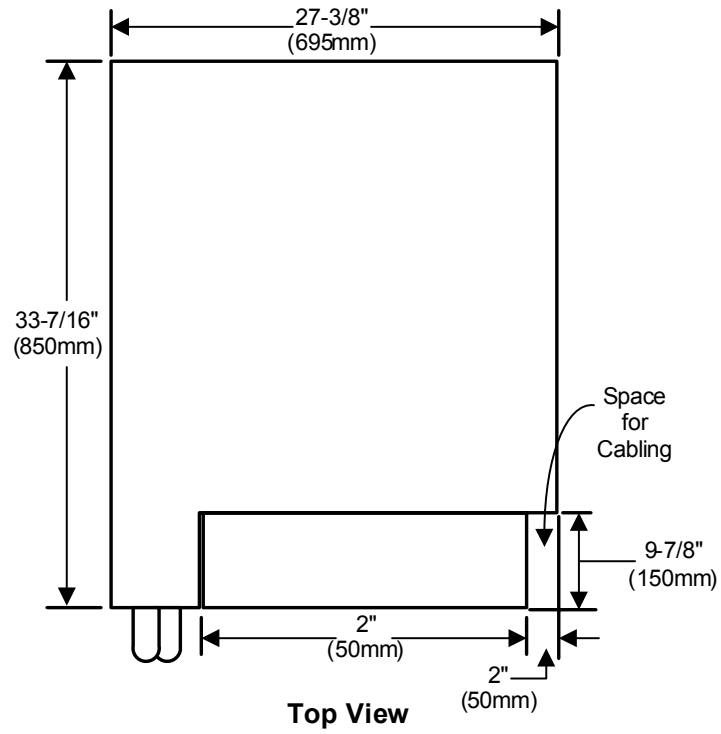
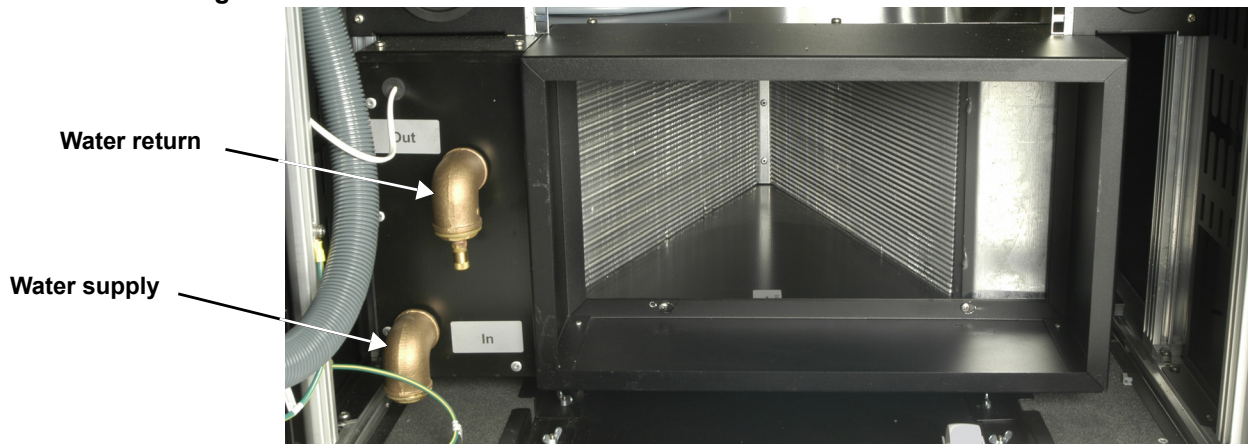
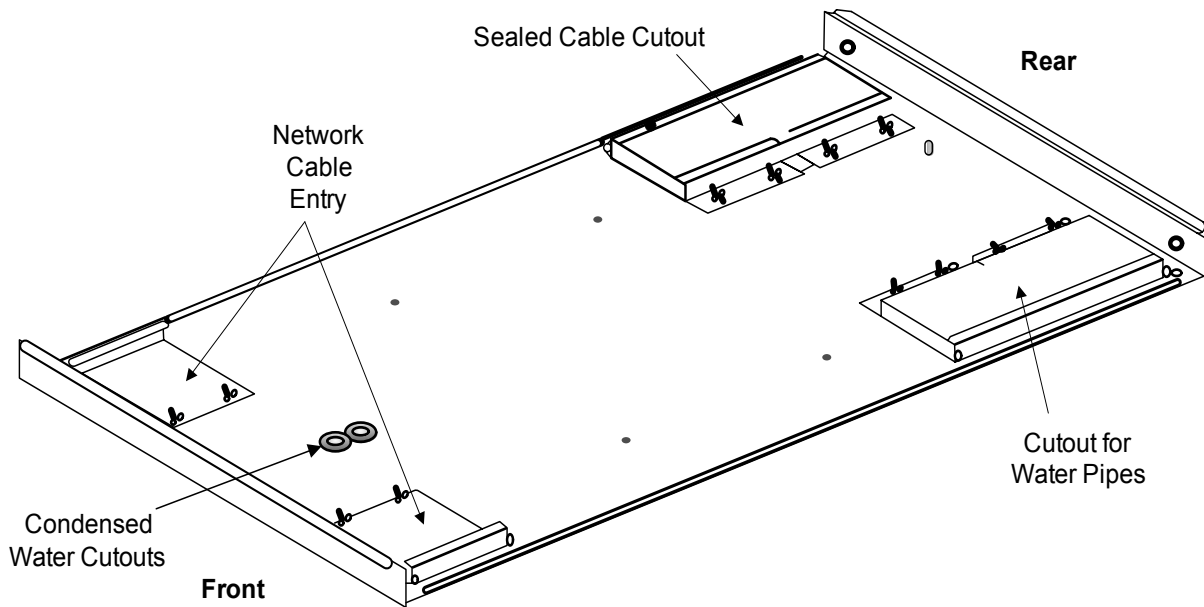

Figure 9 Heat exchanger connection



Liebert recommends insulating the cold water pipes with waterproof insulation to prevent condensation and losses.

Figure 10 Bottom plate with cutouts



Cable and pipe openings must be sealed air-tight on completion of work.

5.4 Condensed Water Connection

If the XDK is operated below dew point, condensed water may occur. As standard there is a water connection, 5/8" diameter, in the condensed water tray for drainage.

Preparations for Connecting

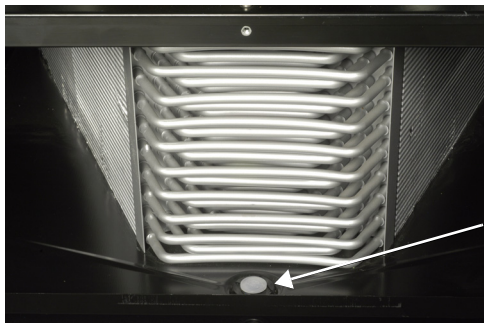

Step 1):
Remove
the air
duct

Condensate
connection



Step 2):
Remove
the cap



Step 3.)
Connect the
nipple with a drain
hose 5/8"

Step 4.)
Move and snap the
nipple with hose
into the hole

When connecting to the condensate tray, ensure that the condensed water pipe is connected to a self-filling siphon with return protection and that the condensate drain is properly sloped.

The height of the siphon must be designed for an underpressure or overpressure of 0.11psi (800 Pa) so that air is not drawn into or blown out of the waste pipe.

The condensate drain is not pressurized; a condensate pump can be used.

5.5 Electrical Connection

The wiring diagram is enclosed in the unit.



WARNING

Risk of electric shock. Can cause injury or death.

Disconnect all local and remote electric power supplies before working within. Prior to beginning installation, shut down the server cabinet, disconnect it and secure it against unauthorized startup.

As soon as all preparations for installation have been made, you can start electrical installation.



WARNING

Risk of electric shock. Can cause injury or death.

Disconnect all local and remote electric power supplies before working within.

The XDK unit must be connected by a licensed and qualified electrician only. Ensure that the server cabinet is electrically isolated for the duration of the connection operation and is secured against unauthorized startup

Check whether voltage and frequency at installation site as well as fuse ratings match the specifications on the rating plate.

To connect the unit to the power supply:

1. Shut down the server cabinet.
2. See the wiring diagram for information on the connections to be made.
3. Connect the supply cable in the computer room.
4. Check the secure connection of the earth wire.

To return the server cabinet to operation, switch on the fuse-protected power supply.



NOTE

The unit's fans will rotate clockwise.

5.6 Sealing the Cabinet

To ensure the optimal cooling function the cabinet must be sealed:

- Pipe entrances should be cut into the foam and properly closed with a extra foam if required.
- Cable entrances should be closed with the pivoting plate and foamed material.
- Air flows on the warm and cold sides of the cabinet must be separated from each other.

6.0 SERVICING AND MAINTENANCE



WARNING

Risk of high speed rotating fan blades. Can cause serious injury.

Disconnect all local and remote electric powers supplies and assure that fan blades have stopped rotating before working within the unit.



WARNING

Risk of electric shock. Can cause injury or death.

Disconnect all local and remote electric power supplies before working within the unit.



CAUTION

Risk of explosive discharge of water under pressure. Can cause injury or equipment damage. Shut off the water supply and relieve pressure before working with piping.



NOTE

Service and maintenance work must be performed only by properly trained personnel and in accordance with applicable regulations as well as with manufacturers' specifications.



NOTE

Use only original spare parts that have been tested and approved by the manufacturer. If necessary, request a comprehensive spare parts list from the manufacturer. For cleaning, use commercially available cleaning agents only. Follow the stipulated safety measures and do not use any tools that may cause scratching or tools for scraping (surfaces will be irreversibly damaged).

6.1 General Inspection on Fans—Annual

- Check for unusual bearing noises. (Check for excessive bearing play.)

6.1.1 Fan Replacement

The expected service life is approximately 40,000 operating hours at a temperature of 40°C (104°F).

1. Remove the housing cover from the unit (with earth cable).
2. Determine which fan has failed.
3. Check the surface temperature of the fan and switch off the circuit breaker.
4. Disconnect supply cable at the fan terminal block.
5. Loosen the four fastening nuts for the fan to be replaced.
6. Remove the failed fan.

Figure 11 Replacing a fan

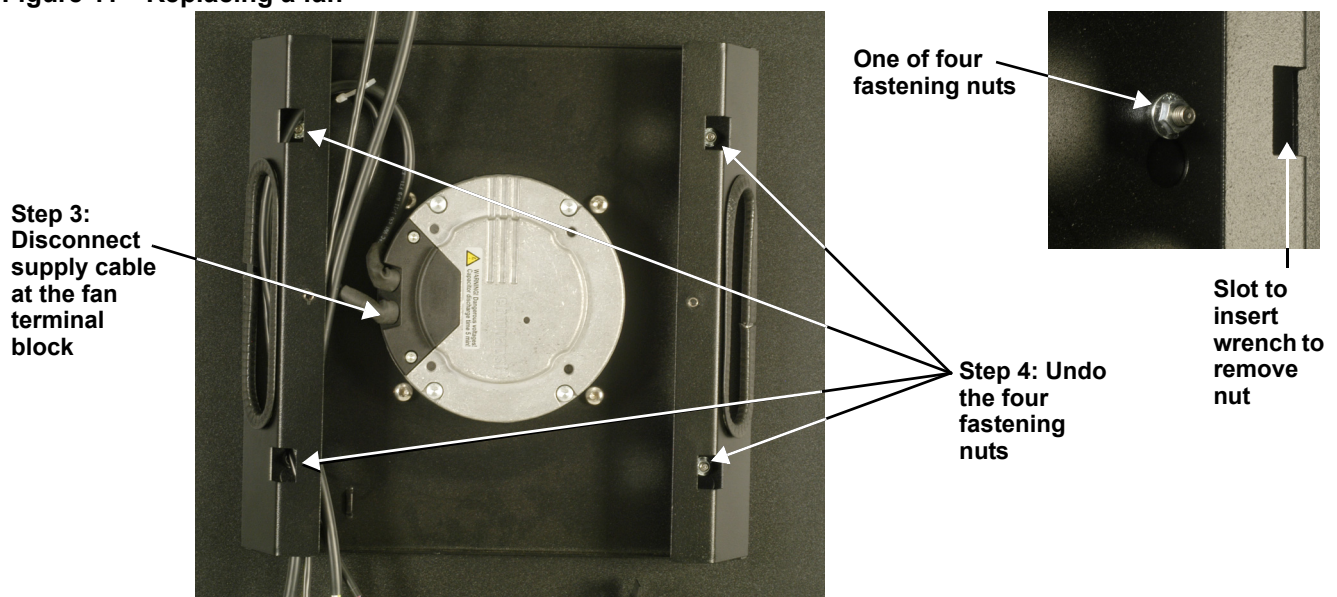

Reinstall the fan by reversing the steps to remove the fan.

1. Tighten the fan fastening bolts.
2. Connect the power supply cable to the fan.



WARNING

Risk of electric shock. Can cause injury or death.

Reconnect the earth ground cable to the sheet metal panel to prevent a potentially hazardous open circuit in case of loose or disconnected electrical wiring or a fan motor short circuit.

3. Switch on the circuit breaker.
4. Dispose of the old fans correctly.

6.2 Inspect the Heat Exchanger—Annual

The efficiency of heat exchangers is sharply reduced by dirt and debris; retaining high efficiency requires regular cleaning. Use a vacuum cleaner, compressed air or a soft brush to clean the fins.

Do not bend the fins during cleaning—this will interfere with proper air flow through the unit.

- Check heat exchanger on air side for soiling, damage and corrosion.
- Check feed and return for correct function.
- If necessary clean the air side.
- Regularly check odor trap (external) for correct function.
- Heat exchanger can be pulled out for improved cleaning.
- Regularly visually inspect the water circuit for leaks.

6.3 Replacing the Heat Exchanger

Figure 12 Heat exchanger replacement

Step 1: Lift the air duct off the flange to remove it.

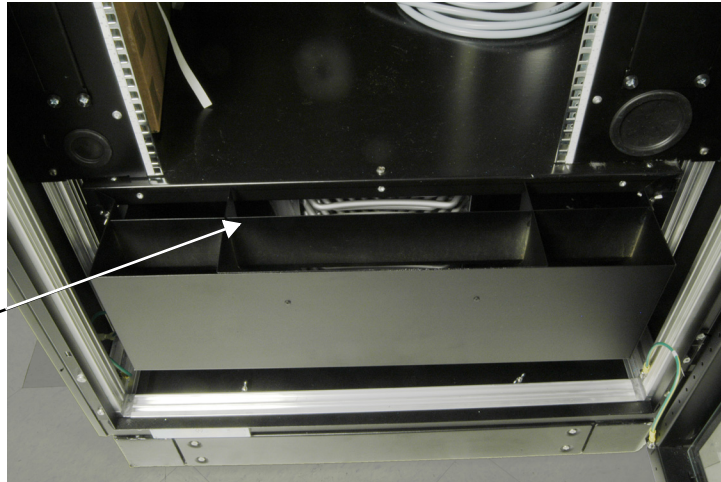

Step 4: Remove screws

Step 5: Pull out the heat exchanger

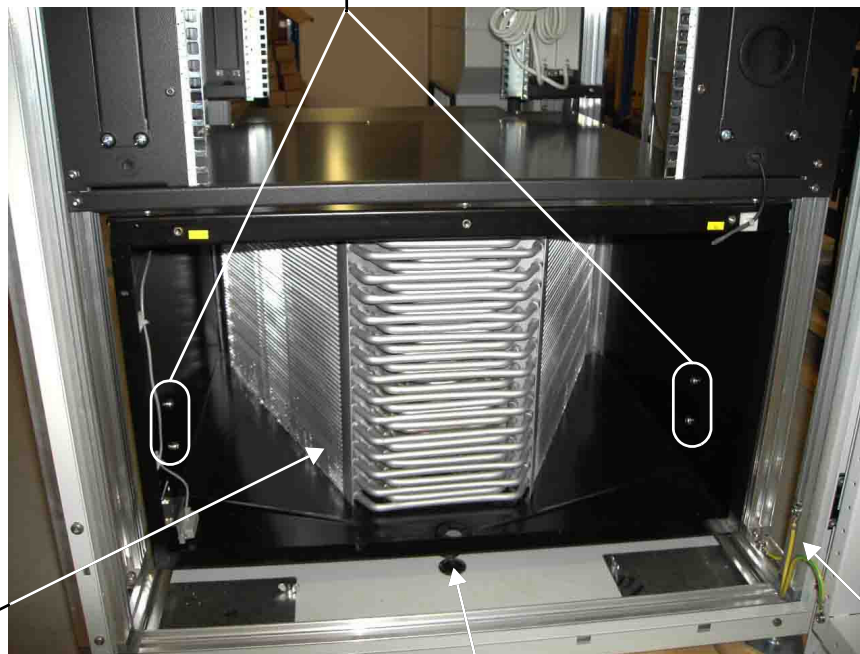

Step 3: Remove condensate connection

Step 2: Remove the grounding cable

Reinstall the heat exchanger by reversing the reverse order of removal.



NOTE

Regularly check the condensed water drain and clean if necessary

7.0 DISMANTLING AND DISPOSAL

The XDK may be dismantled by qualified personnel only.



WARNING

Risk of electric shock. Can cause injury or death.

Disconnect all local and remote electric power supplies before working within the unit.

Disconnect the unit from the external water circuit by closing the shutoff valves and drain the unit's water circuit.

Transport the unit as described in **4.0 - equipment Inspection, Handling And Storage**, using a lifting device with sufficient load-bearing capacity.

Dispose of the air conditioner in accordance with the locally applicable disposal and safety instructions. Liebert recommends using a specialist recycling organization.

All parts can be stripped down and consist of:

- aluminium, steel, brass, copper
- labelled plastic parts
- electronic parts

8.0 WATER PURITY REQUIREMENTS

To ensure the maximum service life of the air/water heat exchangers, water must comply with the VGB water regulations (VGB-R 455 P). The water used must be soft enough to prevent deposits, but it must not be so soft that heat exchanger corrosion occurs.

The following table contains the most important impurities and methods for removing them.

Table 4 Prevalent impurities and removal methods

Water Impurity	Method of Removal
Mechanical pre-treatment (dp < 1 mm)	Filtering the water
Excessive hardness	Soften the water using ion exchange
Moderate content of mechanical impurities and hardness formers	Addition of dispersing or stabilizing agents
Moderate content of chemical impurities	Addition of passivation agents and inhibitors
Biological impurities (bacteria and algae)	Addition of biocides

It is recommended to achieve the following hydrological data as far as possible:

Table 5 Suggested hydrologic levels

Hydrological Data	Suggested Amount	Units
pH values	7 - 8.5	
Carbonate hardness	>3 <8	°dH
Free carbon dioxide	8 - 15	mg/dm ³
Bound carbon dioxide	8 - 15	mg/dm ³
Aggressive carbon dioxide	0	mg/dm ³
Sulfides	< 10	mg/dm ³
Oxygen	< 50	mg/dm ³
Chloride ions	< 250	mg/dm ³
Sulfate ions	< 10	mg/dm ³
Nitrates and nitrides	< 7	mg/dm ³
CSB	< 5	mg/dm ³
Ammonia	< 5	mg/dm ³
Iron	< 0.2	mg/dm ³
Manganese	< 0.2	mg/dm ³
Conductivity	< 2200	μS/cm
Solid evaporation residue	< 500	mg/dm ³
Potassium permanganate consumption	< 25	mg/dm ³
Suspended matter	< 3	mg/dm ³
(Partial flow cleaning is recommended)	> 3 < 15	mg/dm ³
(Continuous cleaning)	> 15	mg/dm ³

8.1 Unit Installation Checklist

- 1. Check unit for damage on delivery
- 2. Check for level floor
- 3. Check maximum floor load
- 4. XDK feet adjusted, if applicable
- 5. XDK is level
- 6. No remains of packaging in the XDK
- 7. All installation tools removed
- 8. Cable entries into the unit correct and air-tight
- 9. Cable connections checked
- 10. Cold water connection does not leak
- 11. Pressure test performed
- 12. Water circuit bled
- 13. Water flow rate adjusted
- 14. Condensed water pipe clear
- 15. Water system odor trap in order
- 16. Heat exchanger tray connected to condensed water pipe
- 17. Fan function checked
- 18. All front panels closed (separation of air flows)

Comments

Signature

Date

Checker

8.2 Commissioning Certificate

Table 6 XDK – Commissioning certificate

General Data

Client/Setup Site

Client Name

Client Address

Contact Persons

Phone Number

Setup Site / Room Number

Table 7 Nominal values at setup site

Air Humidity at Setup Site	% Relative Humidity														
Ambient Temperature	°C (°F)														
Nominal Values at Setup Site															
Temperature °F (°C)	50 (10)	59 (15)	64 (18)	66 (19)	68 (20)	70 (21)	72 (22)	73 (23)	75 (24)	77 (25)	79 (26)	81 (27)	82 (28)	86 (30)	95 (35)
Maximum Relative Humidity %	100	76	62	58	55	52	48	46	43	40	38	36	34	30	23

Nominal values kept

- 1. Yes
- 2. No

Configuration

Table 8 Type of cabinet

	XDK 17kW
Cabinet Number	
Serial Number	
Date Shipped	
Fan	
Type	

Table 9 Control of status

General Condition		
Load Carrying Capacity Checked	Yes	No
Level Alignment Checked	Yes	No
Transportation Damages of Cabinet	Yes	No
Comments		
Damages on Heat Exchanger/Connections	Yes	No
Front Door Closing Easily	Yes	No
Comments:		
Rear Door Closing Easily	Yes	No
Comments:		
Cable Entries Closed	Yes	No
Comments		
Condensate Drain Open / Connected	Yes	No
Comments		
Trap Filled Up	Yes	No
Packaging Removed	Yes	No
Installation Tools Removed	Yes	No
Air Separation (Front Panels Closed)	Yes	No
Cable Entries Air Tight	Yes	No

Table 10 Cold water facility on site

Cold Water				
XDK Connected To				
Water Temperature		Feed	°C/°F	Return
Water Pressure	Feed	PSI (Pa)	Return	PSI (Pa)
Water Differential Pressure	Pa			

Table 11 Electrical data / documents

Wiring Scheme Attached	Yes	No
Comments		
Cable Connections Checked:	Yes	No
Electrical Acceptance Certificate by Approved Staff	Yes	No
Comments		

Table 12 Function check

Function of All Fans (Air Blowing Direction)	Yes	No
Fans Shut Down When Rear Door is Opened	Yes	No
Comments		
Function Three Way Valve	Yes	No
Comments		
Door Opens When ____ °F (°C) is Reached	Yes	No
Comments		

Table 12 Function check (continued)

Malfunction Indicator Function	Yes	No
Comments		
Condensate Occurrence at Heat Exchanger	Yes	No
Comments		
Pressure Test Water Circuit	Yes	
Water Flow Rate Adjusted	Yes	No
Flow Rate (Possible Only Externally)	GPM	
Water Feed	°F (°C)	
Water Return	°F (°C)	
Air Temperature in the Cabinet At The Heat Exchanger Inlet	°F (°C)	
Air Temperature in the Cabinet At the Heat Exchanger Outlet	°F (°C)	

Commissioning performed by day to day operating.

Correctness of function check protocol certified by:

Approved Staff

Date

Signature

Client

Date

Signature

Ensuring The High Availability Of Mission-Critical Data And Applications.

Emerson Network Power, the global leader in enabling business-critical continuity, ensures network resiliency and adaptability through a family of technologies—including Liebert power and cooling technologies—that protect and support business-critical systems. Liebert solutions employ an adaptive architecture that responds to changes in criticality, density and capacity. Enterprises benefit from greater IT system availability, operational flexibility and reduced capital equipment and operating costs.



While every precaution has been taken to ensure the accuracy and completeness of this literature, Liebert Corporation assumes no responsibility and disclaims all liability for damages resulting from use of this information or for any errors or omissions.
© 2007 Liebert Corporation
All rights reserved throughout the world. Specifications subject to change without notice.
® Liebert and the Liebert logo are registered trademarks of Liebert Corporation. All names referred to are trademarks or registered trademarks of their respective owners.

SL-16681_REV0_04-07

Emerson Network Power.

The global leader in enabling *Business-Critical Continuity*.

- | | | | |
|----------------|----------------------|------------------------------|-------------------------------|
| ■ AC Power | ■ Embedded Computing | ■ Outside Plant | ■ Racks & Integrated Cabinets |
| ■ Connectivity | ■ Embedded Power | ■ Power Switching & Controls | ■ Services |
| ■ DC Power | ■ Monitoring | ■ Precision Cooling | ■ Surge Protection |

Technical Support / Service Web Site

www.liebert.com

Monitoring

800-222-5877

monitoring@emersonnetworkpower.com

Outside the US: 614-841-6755

Single-Phase UPS

800-222-5877

upstech@emersonnetworkpower.com

Outside the US: 614-841-6755

Three-Phase UPS

800-543-2378

powertech@emersonnetworkpower.com

Environmental Systems

800-543-2778

Outside the United States

614-888-0246

Locations

United States

1050 Dearborn Drive

P.O. Box 29186

Columbus, OH 43229

Europe

Via Leonardo Da Vinci 8

Zona Industriale Tognana

35028 Piove Di Sacco (PD) Italy

+39 049 9719 111

Fax: +39 049 5841 257

Asia

7/F, Dah Sing Financial Centre

108 Gloucester Road, Wanchai

Hong Kong

852 2572220

Fax: 852 28029250