



Desigo™ RXC

Flexible room unit

QAX50.1
QAX50.5
QAX51.1
QAX51.5

for integrated operation of HVAC, lighting and blinds in individual rooms;
 with LONMARK®-compatible bus communication

-
- Room temperature measurement
 - Buttons for adjustment of the room temperature setpoint
 - Rocker switch for mode selection (⏻ / Auto) and for manual control of the fan in fan-coil systems (up to 3 speeds)
 - LCD with room temperature and control mode display
 - Panel for configurable buttons for the operation of lighting and blinds
 - Off-button (⏻), to switch room lighting off and set HVAC system to an energy-saving mode
 - LONMARK®-compatible bus communications
 - Power supply via the two-wire bus (LONWORKS® bus, LPT-10)
 - Socket for RXT10 commissioning and service tool

The flexible room unit is used in conjunction with the Desigo RXC room automation system for measurement of the room temperature and for integrated operation of HVAC, lighting and blinds. The HVAC functions are identical to those of the QAX34.1 room unit.

The functions for operating lighting and blinds can be configured flexibly to match the requirements in the room. This involves fitting the required rocker switches and downloading the associated application software (referred to further on as the “application”). The various applications are described individually in the Desigo RXC Applications library, CA2A3810 (V1) or CA110300 (V2).

The flexible room unit is delivered in its unconfigured state (see “Ordering”). The room units must be fitted with buttons/rocker switches and loaded with the application at the commissioning stage. The latter process is carried out with the RXT10 commissioning and service tool (see “Commissioning notes”).

Type summary

The flexible room unit is available in two basic versions, which differ only in the number and type of buttons/rocker switches supplied.

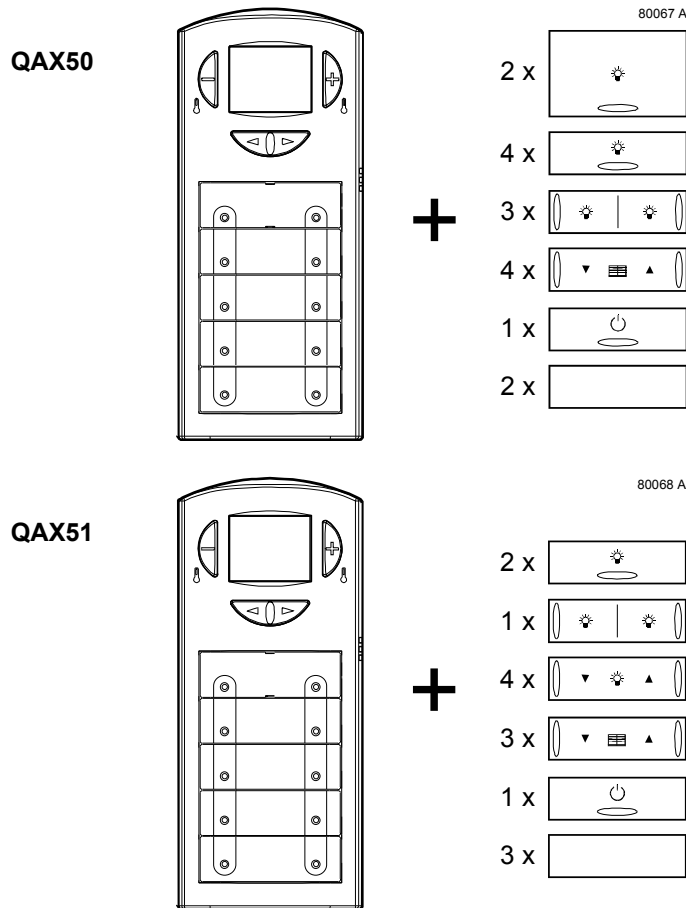

Type QAX50 is used for all applications involving **on/off** lighting control.

Type QAX51 is required for **dimmer** control.

Product No.	Stock number	Designation
QAX50.5/C000	S55623-H114	Flexible room unit (on/off lighting control)
QAX51.5/C000	S55623-H115	Flexible room unit (dimmer control)

Ordering

When ordering, please specify the quantity, product name, type code and configuration.

Unconfigured room units

Unconfigured units are available only in the basic versions shown under “Type summary” above. The configuration code for these units is C000.

Example:

7 Flexible room units QAX51.5 / C000

Button sets

The two different button sets can also be ordered separately:

- **Set A: SAP ordering No. 4268 277 30 (on/off lighting control)**
- **Set B: SAP ordering No. 4268 277 40 (dimmer control)**

Equipment combinations

The QAX50 and QAX51 are primarily used in conjunction with the RXC30 / RXC31 / RXC38 room controllers and the associated extension modules, types RXC40 and RXC41.

The room units are also used in conjunction with the RXC20, RXC21, or RXC22 for fan-coil applications.

The flexible room units can also be used for the control of lighting and blinds (and to a limited extent HVAC) in conjunction with LONMARK®-compatible third-party devices.

Mechanical design

The room unit is designed for mounting on a recessed conduit box. The bus cable is connected to the unit from the rear with a plug-in connection.

Essentially, the flexible room units comprise a housing and base unit, connected by releasable snap-fittings.

The housing accommodates a printed circuit board, room temperature sensor element, buttons for setpoint adjustment, mode selection and fan-speed control, the LCD panel, a configurable control panel, a plug-in connector for the bus and a socket for the RXT10 commissioning and service tool.

The configurable control panel incorporates two rubber membranes and a total of 10 contact points. The contacts are operated by the buttons and rocker switches fitted into the panel.

The flexible room unit has a plastic housing and a galvanized steel mounting plate.

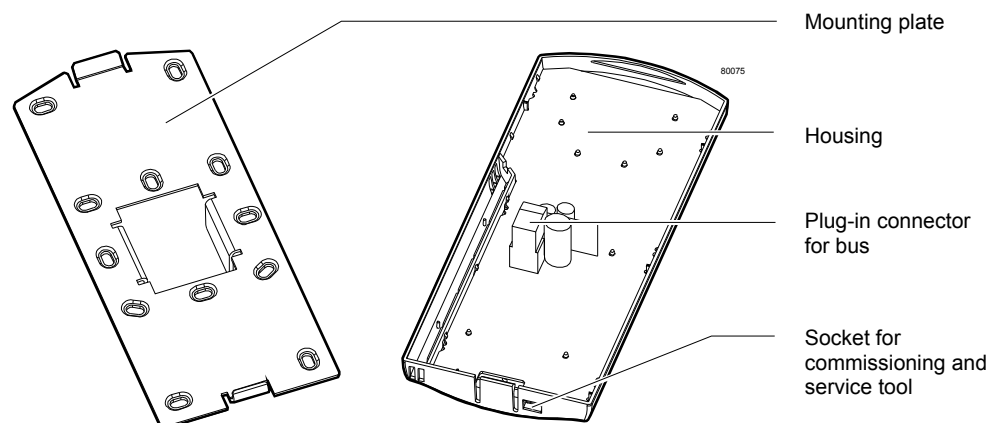

Operator controls and display

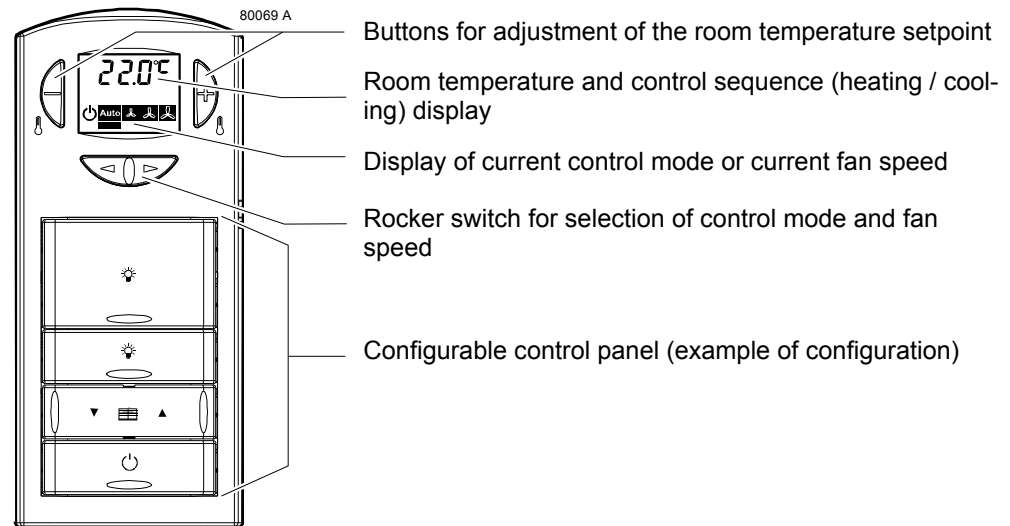

Note

The actual functions of the operator controls and display panel are determined by the downloaded application. The description below covers all the possible options.

Rocker switch for mode selection and fan-speed control

The control mode of the connected room controller can be selected with the rocker switch. The same switch is used for manual control of the up to three fan speeds.

Pressing once in the direction of the left arrow switches one stage to the left, and pressing once in the direction of the right arrow switches one stage to the right.

The current control mode or manually-selected fan speed is indicated in the display panel by a horizontal bar below the associated symbol.

Position	Fan speed control ¹⁾	Control mode ¹⁾
	Fan controlled automatically by room controller	<i>Pre-comfort or Economy</i> (according to central control)
Auto	Fan controlled automatically by room controller	<i>Comfort</i>
	Manual, fan speed 1	
	Manual, fan speed 2	
	Manual, fan speed 3	

1) For function descriptions of the relevant HVAC applications refer to the Desigo RXC Applications library, CA2A3810 (V1) or CA110300 (V2).

Note









The operation of this rocker switch has no effect on the control of lighting or blinds.

Buttons for room temperature setpoint adjustment

Press the button once to switch from a display of the current room temperature to a display of the setpoint. Each further operation of the + or – button raises or lowers the setpoint by 0.5 K or 1.0 °F. The unit of measurement and the maximum allowable adjustment range is determined by parameters in the application software.

LCD display







In normal operation, the following may be displayed (depending on the application parameters) For details refer to the Desigo RXC Applications library, CA2A3810 (V1) or CA110300 (V2).:

Display element (examples)	Description
	Room temperature in °C (resolution 0.5 °C)
	Room temperature in °F (resolution 1.0 °F)
	Digital display of setpoint adjustment (displayed only while relative adjustment is in progress).
	Digital display and scale (displayed only while absolute adjustment is in progress)
	Control sequence: Cooling
	Control sequence: Heating
	Room units with mode and fan-speed selection enabled: Fan speed 1: <i>ON</i>
	In room units allowing mode selection only: Auto: <i>ON</i>

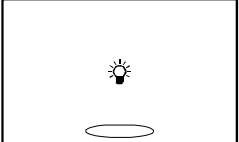
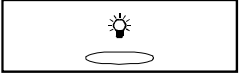
Configurable control panel

The configurable control panel can be fitted according to requirements with a variety of buttons and rocker switches.

The following options are available:

	Large button for on/off control of lighting
	Standard button for on/off control of lighting
	Rocker switch for on/off control of two lighting units
	Rocker switch for dimmer control
	Rocker switch for control of blinds
	OFF button: Switches all room lighting off Switches the connected room controller to <i>Pre-comfort</i> or <i>Economy</i>
	Blank plate (no function)

Note

Flexible room units configured with an OFF button incorporate the following additional function:

If the connected room controller is in *Pre-comfort* or *Economy* mode, it will switch to *Comfort* as soon as any of the rocker switches or buttons on the room unit are operated.

Removing the buttons/rocker switches

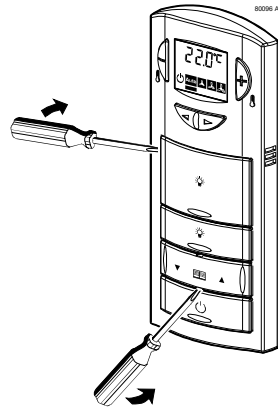

“Search” LED

There are two LEDs under the top button/rocker switch on the configurable control panel. These remain permanently on so that the unit can be located more easily in the dark.

“Service” LED

The yellow “Service” LED is fitted under the last button/rocker switch on the configurable panel and indicates the status of the room unit by means of different flashing patterns (see the RXT10 user manual, CM110669).

Disposal



The devices are classified as waste electronic equipment in terms of the European Directive 2002/96/EC (WEEE) and should not be disposed of as unsorted municipal waste. The relevant national legal rules are to be adhered to.

Regarding disposal, use the systems setup for collecting electronic waste. Observe all local and applicable laws.

Engineering notes

The flexible room unit is connected to the LONWORKS® bus by a two-wire twisted cable and receives its power via the bus cable. This cable must be connected to a central bus power supply in accordance with LPT-10 (see the Installation guide, CA110334).

For mounting, a standard recessed conduit box or an aperture of the equivalent size is required.

Mounting notes

- The room unit must be mounted on a recessed conduit box
- Mount on a flat surface with a maximum offset of 1 mm
- The base plate should be fixed with screws, max. diameter 3.5 mm
- Do not mount in recesses, shelves, behind curtains or doors, or above or near heat sources.
- Avoid exposure to direct sunlight or draughts.
- The electrical wiring conduit must be sealed where it joins the room unit, to prevent the occurrence of draughts in the conduit which could affect the sensor.
- The specified ambient conditions must be complied with.

Mounting instructions are printed on the room unit packaging.

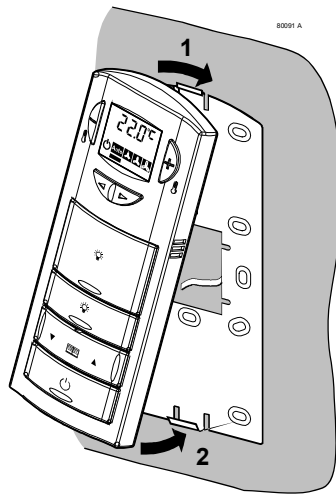

Fit to top rail (1) and snap-mount on bottom rail (2)

Installation notes

- Local installation regulations must be observed.
- Do not route mains voltage cables to the conduit box.
- Use only the original bus plug.



Warning

The room unit is not protected against connection to AC 230 V.

Commissioning notes

The QAX50 and QAX51 flexible room units are commissioned with the RXT10 commissioning and service tool. This is connected to the LONWORKS® bus via the tool socket.

The RXT10 user manual (CM110669) contains a step-by-step commissioning procedure for the entire Desigo RXC range.

Response on start-up

When the supply voltage is connected (via the LONWORKS® bus) the room unit runs a self-test, during which all segments of the LCD are enabled. At the end of the self-test, the LCD panel reverts to the normal display.

“Service pin” function

The “service pin” function, which is used to transmit the identification number of the unit to the bus can be enabled by simultaneously pressing the two setpoint adjustment buttons and the mode selection/fan-speed rocker switch (to the left or right). The LCD panel displays *SPI n* for approximately 1 to 2 s in acknowledgement.

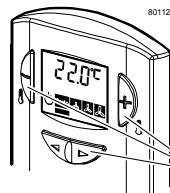

Press simultaneously

Wink function display

If the RXT10 commissioning and service tool is used to issue an identification command to in the room unit (wink function), the LCD panel responds with the display *r. 50*. This display persists for a maximum of 64 s or until a rocker switch or button is operated. The room unit then reverts to the normal display.

Notes on operation

During normal operation and commissioning, the LCD panel also serves to display error messages:

Display	Description
E 1	Room temperature sensor outside range 0 ... 40 °C

Technical data

Power supply	Operating voltage	SELV / PELV Max. DC 42 V
	The Room unit receives its power via the LONWORKS® bus in accordance with specification LPT-10	
	Power consumption	Max. 0.3 W
Function data	Temperature sensor	
	Measuring element	NTC resistor
	Measuring range	0 ... 40 °C
	Response time	≤ 9 min
	Measuring accuracy (5 ... 30 °C)	± 0.5 K
	Measuring accuracy (25 °C)	± 0.25 K
	Setpoint correction	
	Correction range (defined by application parameters)	Max. ± 10 K (default ± 3 K)
	Display	
	Type	LCD
	Functions displayed	<ul style="list-style-type: none">– Room temperature– Setpoint adjustment– Operating status– Manually selected fan speed– Control sequence (heating / cooling)
	Configurable operator panel	
	Number of contact points	10
Max. number of buttons/rocker switches	5	
Functions	<ul style="list-style-type: none">– On/off control of lighting– Lighting dimmer control– Blinds up/down and adjustment of slat angle– OFF button	
Interfaces	LONWORKS® bus	
	Interface type	LONMARK®-compatible
	Transceiver	LPT-10
	Baud rate	78 kBit/s
	Bus topology and bus termination	See Installation guide, CA110334
Cable connection	Connection terminals (plug-in screw terminals)	Solid or stranded conductors 2 x 1.0 mm ²
	Single cable lengths	See also Installation guide, CA110334
	LONWORKS® bus	Max. 500 m
	Cable type	See Installation guide, CA110334
	Tool connecting cable	Max. 3 m (manufactured)

Housing protection standard	Protection standard to EN 60529	IP 30
Protection class	Insulation protection class	III
Ambient conditions	Operation	IEC 721
	Ambient air conditions	Class 3K5
	Temperature	0 ... 50 °C
	Humidity	< 85 %rh
	Mechanical conditions	Class 3M2
	Transport	IEC 721
	Ambient air conditions	Class 2K3
	Temperature	- 25 ... 70 °C
	Humidity	< 95 %rh
	Mechanical conditions	Class 2M2
Standards and directives	Product safety	
	Product standard Automatic electronic controls for household and similar use	EN 60730-1
	Electromagnetic compatibility	
	Immunity (industrial & residential)	EN 60730-1
	Emissions (residential)	EN 60730-1
	CE compliance	
	Meets requirements of EMC directive	2004/108/EC
	UL compliance	UL916
C-Tick conformity (EMC)	AS/NZS 61000-6-3	
Environmental compatibility	The product environmental declaration	ISO 14001 (Environment)
	CA2E1648 contains data on materials composition, packaging, environmental benefit, disposal	ISO 9001 (Quality)
Dimensions	See "Dimensions"	
Color	Front plate and operator control panel	NCS S 0502-G, ≈ RAL 9003 signal white
	Buttons/rocker switches for setpoint adjustment and mode selection	RAL 7035 light grey
Weight	Excluding packaging	0.175 kg

Connection terminals

The LONWORKS® bus connection terminals are removable, so that if the bus cable is looped, the room unit can be separated from the bus without causing an open circuit.

Terminal layout

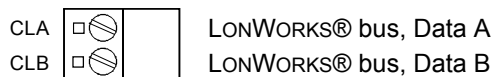

Tool socket

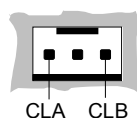

Dimensions

All dimensions in mm

