



OPTi

OPTi Lite

User Manual

Table of Contents

Contents of the OPTi package.....	4
Installation	4
Charging OPTi Lite	4
OPTi software	5
Keep on Top.....	7
Sleep mode On/Off.....	8
Views and the Views Manager	9
Video controls	12
Lights On/Off.....	14
Capture	14
Hide toolbar	16
Exit Program	17
Main menu	17
File.....	18
View	19
Options	19
Options ... Preferences.....	19
Options ... Button Functions.....	22
Options ... Colours.....	24
Options ... Markers	25

Lights	26
Help	26
OPTi Lite Control panel	26
Image Quality	28
OPTi and Screen Magnification software	Error! Bookmark not defined.
AI Squared: ZoomText	Error! Bookmark not defined.
Dolphin: Supernova.....	Error! Bookmark not defined.
OPTi Sounds.....	Error! Bookmark not defined.
Adjusting the Magnification	34
Adjusting the Focus	36
Reading with OPTi Lite	36
Writing	37
Hints and Tips	38
Taking Care of your OPTi Lite	38
Warranty	40

This page is deliberately left blank

Contents of the OPTi package

- The OPTi Lite unit with integrated base and USB cable
- Charger with mains lead
- Carry case
- OPTi CDROM with application
- The User's manual
- Installation guide
- Quick reference guide

Installation

 The OPTi requires that you first carry out the software installation before plugging the unit into your computer. Please refer to the installation guide before continuing.

Charging OPTi Lite

OPTi Lite contains a rechargeable battery which must be charged periodically if you

want to use it on the move. Simply plug the charger into the base of the unit and a wall socket and leave it to charge. The battery will be fully charged in 4 hours and should last approximately 10 hours of usage. The unit can be used while it is charging.

OPTi software

The OPTi software consists of the video window and the toolbar. The video window displays the real time video image captured by the unit itself. The video window is movable and resizable both horizontally and vertically.

The toolbar window displays the main controls for the software. This allows you quick access to the video control features and to the main menu.

As you move text or an image under the OPTi's camera, the image will be displayed on the video window. There are many features on the OPTi software that allow you to optimise the display for your particular requirements.



Shortcut keys in this manual are described in the form "**Ctrl+X**". This means that you press and hold the control key and press the letter ("X").

The shortcut keys only have effect when OPTi is the active program; they are not trapped by OPTi and may have another function entirely in other programs.

The one exception to this is the Scroll-Lock button, this button is trapped by OPTi. Pressing this button will make OPTi the active application, and so OPTi will appear on top of any other program that is running.

The toolbar explained

The following section explains function of the buttons on the OPTi toolbar. The complete toolbar is illustrated below.



Each of the buttons functions is explained in this section along with their equivalent keyboard shortcuts. On OPTi Lite it is also possible to program the control panel buttons to perform some of these functions. This allows you three ways to control OPTi, the PC mouse, the PC keyboard and the control panel on the front of the unit itself.

Keep on Top

Toolbar: 

Keyboard: **Ctrl+T**

“Keep on top” forces the OPTi video window on top of any other program window. For example, in the image on the next page the user is typing in MS Word but the OPTi video window is sitting ‘on

top' of MS Word and is visible even though Word is the active application.

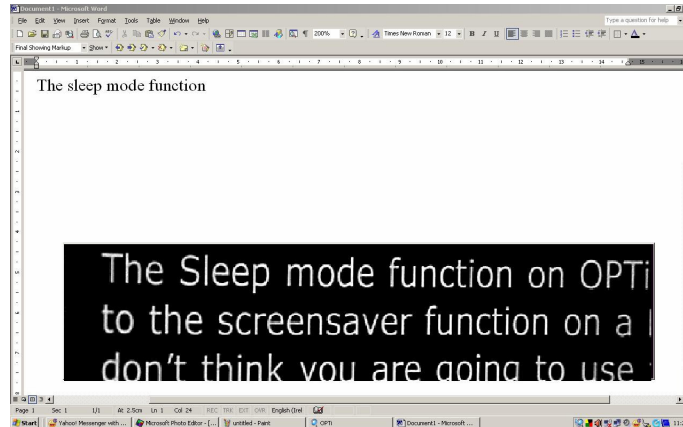

Sleep mode On/Off

Toolbar: 

Keyboard: **Ctrl + S**

The Sleep mode function on OPTi is similar to the screensaver function on a PC. If you don't think you are going to use your OPTi for a while but want to leave the program running, you can save battery power by simply putting OPTi into Sleep mode. This causes the video window to disappear and turns off OPTi's internal circuitry.

Full Screen

Toolbar: 

Keyboard: **Ctrl+F**

When OPTi is in full screen mode the video window takes up the entire screen and only the toolbar window will be visible over the video window.

Views and the Views Manager

Toolbar:  to cycle

Keyboard: **Ctrl + Shift + 0...9** to save

Ctrl + 0...9 to recall

Ctrl + V to cycle the views

When you have set up the display the way you want it, you can store the settings for later recall. In fact you can store ten arrangements or "views" which can be recalled as you desire.

When you start the program for the first time all ten views will be at the default setting.

If you make a change to a view you can store it as one of the ten views (View 0 to View 9) as follows:

Ctrl + Shift + 0 to save as view 0

Ctrl + Shift + 1 to save as view 1

and so on up to

Ctrl + Shift + 9 to save as view 9

You will be prompted to confirm that you wish to save the current layout.



Note that you cannot store a setting at full screen. You should instead use Page Up to enlarge the window to the maximum size and then save this instead.

To recall the stored views, press **Ctrl + 0** to **Ctrl + 9**. You will be prompted to save any changes you made to the current view when you change to another view.

You can use the Views Manager to look at the views you have stored. You can access this from the menu by pressing the Menu button  (see page 17), then "Views" and then "Views Manager". Choosing view 0 to 9 will display a preview of the view as it would appear on the screen in the colours stored for that view. You can choose OK to select a view. The image below shows a screen grab of the Views Manager.

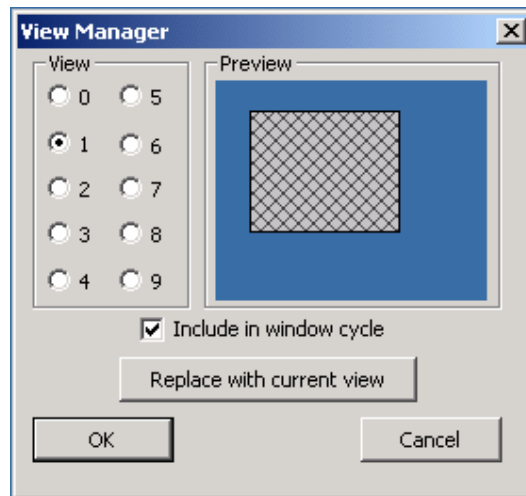



The "Replace with current view" button will store the current screen layout into the selected view. In the case above, view 1 would be replaced with the current view.

The "Include in window cycle" checkbox can be set for each of the ten views. If this box is checked for a particular view then that view will be displayed in rotation as

you cycle through the views with the  button on the toolbar or by pressing **Ctrl + V** on the keyboard, or alternatively with one of the front panel buttons programmed to cycle views. (Programming the front panel buttons is covered later in this manual.)

Video controls

Toolbar: 

The video controls allow you to control the brightness and contrast and saturation of the OPTi image. Press  on the toolbar or from the menu by pressing the menu button  (see page 17) choose "Options", "Video controls" (Keyboard: **Ctrl + M, O, V**). The Video controls dialog box is shown below will appear.

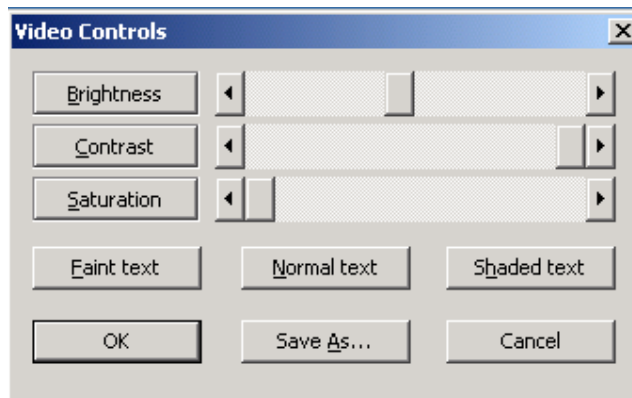

The slider controls can be adjusted as you desire. You can use the mouse to move them or you can use the keyboard. For example to change the brightness of the image, press "B" and then use the arrow keys on your keyboard to move the slider left and right. Once you are happy with the settings press OK or press "Enter". The "Faint text", "Normal text" and "Shaded text" buttons allow you to store settings that are best suited for viewing text in those conditions.

For example if you are reading very faint text you may want to turn down the contrast. When you are happy with the image press the "Save As" button (Keyboard: A) you will see the following dialog box:

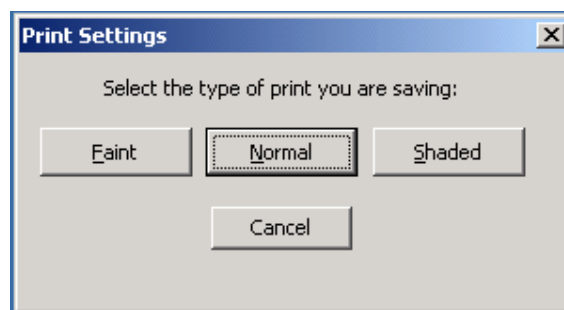

If you then press the "Faint" button (Keyboard: F) your video settings will be stored, and the next time you are viewing



faint text you can recall them by pressing the "Faint text" button on the video settings dialog.

The video settings for Photo, Positive and Negative are independent of each other. Also these settings are saved with each view.

Lights On/Off

Toolbar: 

Keyboard: **Ctrl + L**

OPTi Lite is equipped with an integrated light that can be turned on or off as desired. The light can be controlled using the  button on the toolbar or from the menu by pressing the menu button  (see page 17) choose "Lights" and from there choose to turn them on or off.

Capture

Toolbar: 

Keyboard: **Ctrl + C**

The capture button allows you to take a photograph of the image currently being displayed on OPTi's video window. The image is saved as a .bmp file into a folder on your computer hard drive. The folder is created automatically when you install the software. It is located in the "My Pictures" folder on your computer and is called "OPTi Images". It is advisable to create a shortcut to this folder on your desktop.

To operate the snapshot you can press the  button or from the keyboard press **Ctrl+C**.



The OPTi Images folder is created when the software is installed. It is very important that you do not move or rename this folder. If you do then the snapshot function will not work.

Images are saved as "OPTiImg001.bmp". Every time you take an image the file name increments. The screen grab shows how the folder will look after several snapshots have been taken.

OPTi Lite User Manual

 OPTiImg94.bmp	901 KB	Bitmap Image	05/04/2006 15:24
 OPTiImg95.bmp	901 KB	Bitmap Image	05/04/2006 15:40
 OPTiImg96.bmp	901 KB	Bitmap Image	05/04/2006 15:40
 OPTiImg97.bmp	901 KB	Bitmap Image	05/04/2006 16:31
 OPTiImg98.bmp	901 KB	Bitmap Image	05/04/2006 16:31
 OPTiImg99.bmp	901 KB	Bitmap Image	05/04/2006 16:32
 OPTiImg100.bmp	901 KB	Bitmap Image	05/04/2006 16:33

As you can see the file name increments by 1 each time a picture is taken.

Hide toolbar

Toolbar: 

The hide toolbar button allows you to remove the toolbar from the display. This is useful if you want to view in full screen with nothing else visible. You can bring the toolbar back by clicking on the OPTi icon in the system tray as show in the screen grab below.



Alternatively, if you put the mouse cursor on the video display and right click the main menu will appear. From this choose

“Options”, “Preferences” and then in the Preferences dialog box you can select where you wish the toolbar to be placed. (Keyboard: **Ctrl+M,O,P**)

(OPTi’s preferences menu will be explained in the next section)

Exit Program

Toolbar: 

Keyboard: Alt + F4

This button can be used to exit the program. Alternatively you can use the menu by pressing the menu button  (see page 17) and choose “File” “Exit” or by pressing **Alt+F4**.

Main menu

Toolbar: 

Keyboard: **Ctrl + M**

All of OPTi Lite’s features can be accessed from its popup menu. To display the menu, press the  button on the toolbar or right

clicking on the video window. You can also access the main menu from the keyboard by pressing **Ctrl + M**.

The main menu allows you to access all of the program features and appears as follows:

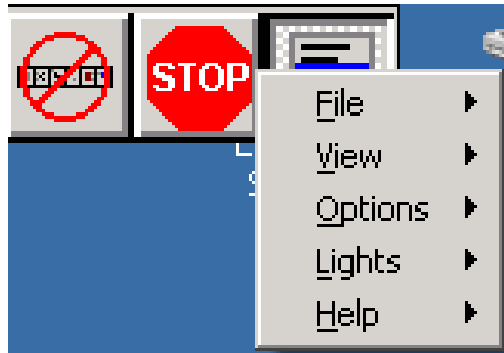

Each of the submenus allows you to access different features in the software. Most of these functions are accessible directly from the toolbar, but some are not. The menu functions are explained below.

File

The File submenu allows you to put OPTi into **Sleep** mode, enable or disable the **Keep on top** feature or to **Exit** the program.

View

The View submenu allows you to select the view you wish to use. This is an alternative to pressing Ctrl+0, Ctrl+1 and so on. You can also access the Views Manager dialog box from here. Refer to the section on the views manager on page 11

Options

The Options submenu allows you to access the Video Controls, Preferences Button functions, Colours and Markers. Video Controls have been described on page 12 and the subsequent sections will detail the operation of the Preferences, Button functions, Colours and Markers.

Options ... Preferences

From the menu choose "Options", "Preferences" (Keyboard: **Ctrl + M,O,P**)
The preferences menu appears as follows;

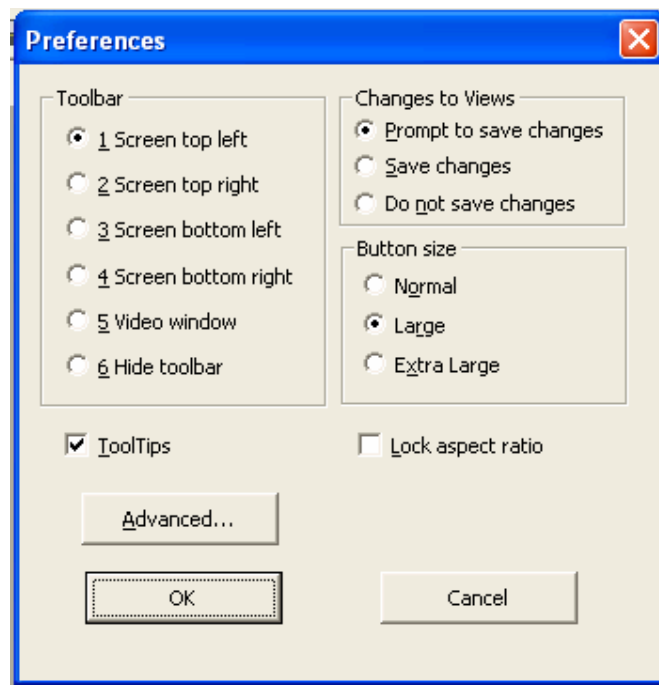

- You can use the “Toolbar” controls to select where the toolbar is displayed. Note that the “Screen top left” and “Screen top right” deliberately leave room for the Windows control buttons. Choosing “Video window” will attach the toolbar to the top left of the display window. You can also choose to hide the toolbar.
- If you do not want to be prompted to save changes to the current view you can choose to automatically accept or

reject all changes with the “Changes to Views” option you select.

- OPTi can display the toolbar in three different sizes, these are normal, large and extra large, the image below shows a comparison of how these appear from smallest to largest

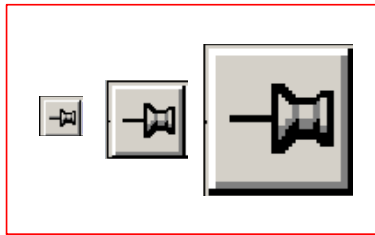

- ToolTips may be turned off by un-checking the ToolTips checkbox.
- Un-checking the “Lock Aspect Ratio” will allow the video to be stretched to fill the display window. If the display window is set to be taller than wide the video will appear in tall, skinny characters. If the display is much wider than tall the video will appear fatter than normal. This setting may produce an image that is easier to read for certain eye conditions.

The “Advanced” button opens up another window with the following options;

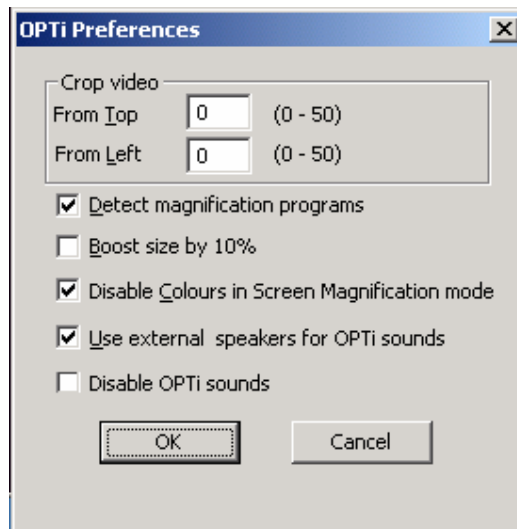

This menu allows you to crop the video image, to boost the size of the displayed text by 10% and to automatically detect screen magnification programs. In normal use these settings are not needed when you are using OPTi.

Options ... Button Functions

OPTi Lite has two buttons on the front of the control panel marked as “*” and “#”. These buttons can be programmed to perform one of a number of functions. From the menu choose “Options”, “Button Functions” (Keyboard: **Ctrl+ M, O, B**). This window appears as follows:

OPTi Lite User Manual

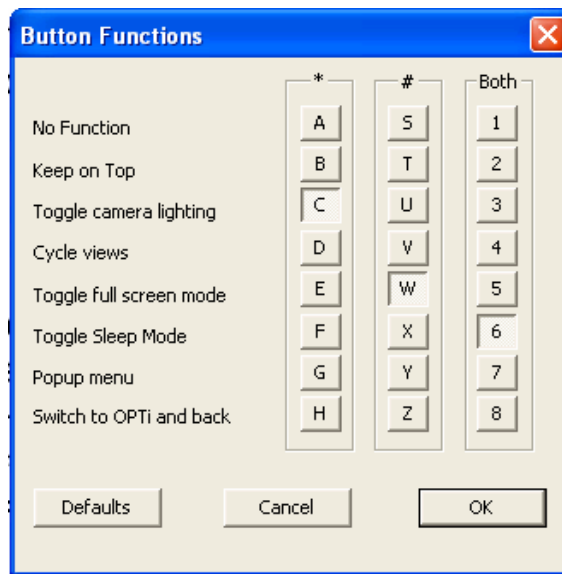

Use the mouse to choose the function you desire for the "*" button the "#" button, or for both buttons pressed together. You can also use the keyboard to program the buttons, for example, pressing "C" on the keyboard programs the "*" button to turn the lights on or off when you press it. By pressing "W" on the keyboard the "#" button is programmed to turn on or off full screen mode when you press it. The image below shows the location of the buttons on the control panel.

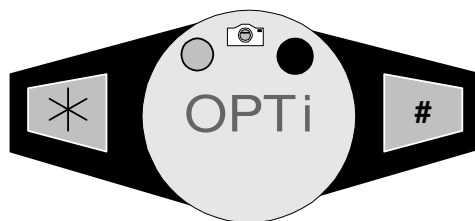

The functions you can program the buttons to do are self-explanatory with the

exception of "Switch to OPTi and back". This is equivalent to pressing scroll lock on the keyboard.

Options ... Colours

The colours used to display the text and paper can be altered. From the menu choose "Options" and "Colours" (Keyboard: **Ctrl+ M, O ,V**). A dialog box appears as follows:

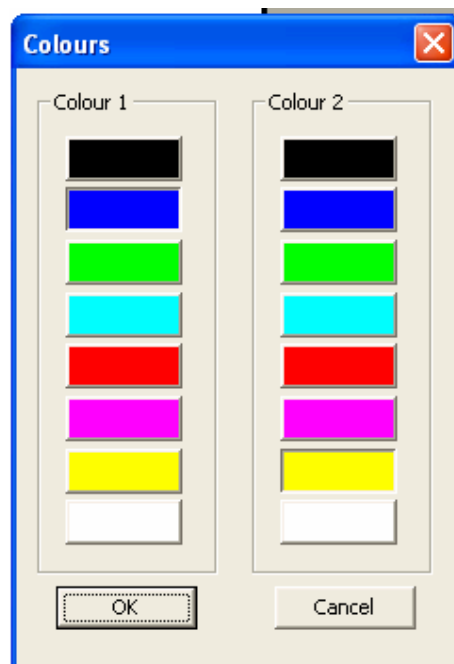

From the dialog box above you can choose the foreground and background colour that you require. You cannot select the same foreground and background colour. If you

are using the keyboard, you can switch between the colours by using the Tab key.

Alternatively you can select the required foreground or background colour from the keyboard. Use **Alt + ←, →, ↓, ↑** to cycle between the available colours.

You must be in Positive or Negative mode for this menu to work. You cannot change the foreground and background colours when you have the unit in full colour mode.

Options ... Markers

OPTi also has an adjustable reading line and line marker that you can turn on and off as required. From the menu choose "Options" , "Markers" (Keyboard: **Ctrl + H**) The dialog box shown below will then appear.

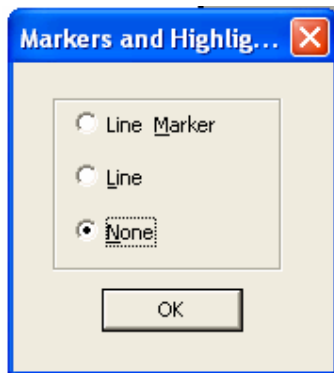

The position of the line or the line marker is adjustable from the keyboard using **Ctrl+ PgUp** or **Ctrl+ PgDn**. The images below show how these features appear when viewing text.

highly transportable configuration weighing just over 1kg
A wide and varied range of
tasks can be performed such
as needlework, model

highly transportable configuration weighing just over 1kg
A wide and varied range of
tasks can be performed such
as needlework, model
making and drawing

Lights

This submenu allows you to turn on or off the integrated light.

Help

The help submenu allows you to access the online help, (Keyboard: **F1**), reset the programme to factory defaults and view the About window.

OPTi Lite Control panel

As explained in the previous section the OPTi Lite has two buttons on the front panel that can be programmed to perform

a number of different functions. The front panel also has a circular switch on the front. This switch is used to select between full colour mode and one of two high contrast modes. The images below illustrate this operation.



Full Colour

Moving the disp
The display windo
location on the sci
it or by using **Shif**



High contrast
Negative

Moving the disp
The display windo
location on the sci
it or by using **Shif**



High contrast
Positive

Moving the disp
The display windo
location on the sci
it or by using **Shif**

Image Quality

The quality of the video displayed on the OPTi screen can be controlled using the Image Quality window. You can access this by pressing **Shift+N** on the keyboard. The window appears as follows on the desktop:

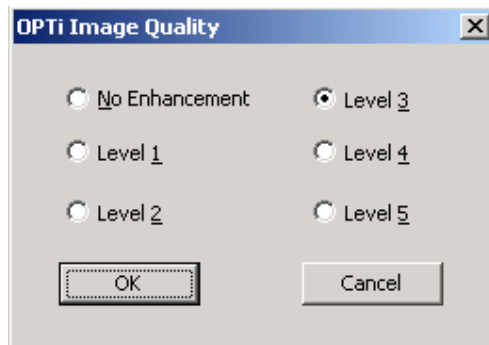

Image quality control window

There are six levels of quality enhancement available to the user, starting at No Enhancement and progressing to Level 5 enhancement. OPTi defaults to Level 3 enhancement. This gives excellent image quality with very little impact on PC resources.

To change the image enhancement setting simply select the level you desire and click on OK. The OPTi image will disappear from the desktop for about 4 seconds before reappearing. When video reappears OPTi

will be operating at the new image setting. The image enhancement control affects how the OPTi image appears when the camera or the object of interest is moving.

OPTi and Screen Magnification software

OPTi Vista Versions 1.2 and above are compatible with the following screen magnification software:

BRAND	PRODUCT
Dolphin Oceanic	Supernova V8.01 and above
AI Squared	ZoomText V9.1 and above

OPTi works differently when it is running in screen magnification mode. This section describes how to use OPTi with screen magnification software.

When OPTi starts it checks to see if any supported screen magnification programs are currently running, if they are the software will change from normal mode to compatible mode during start up.

Once OPTi detects the screen magnification software it adjusts its settings to those required for operation with screen magnification on.

AI Squared: ZoomText

If ZoomText is active on the User's computer then OPTi will start-up with the toolbar visible as shown:



The toolbar only has the stop/exit application button available.

An information box appears indicating to the user that magnification needs to be turned off for OPTi to become available:



The OPTi will only operate when ZoomText magnification is turned off. OPTi can start up while ZoomText is running but unless magnification is turned off the OPTi video window and fully functional toolbar will not be available. When magnification is turned off the OPTi video window appears and full toolbar functionality is made available.

Dolphin: Supernova

If Supernova is active on the User's computer then OPTi will start-up in Sleep Mode with the toolbar visible as shown:



The toolbar will appear with limited functionality available. The only available functions are sleep, hide toolbar and exit.

When in this mode you either have the screen filled with OPTi video or with the desktop. To swap between the OPTi video window and the desktop you simply press the Sleep toolbar button or hotkey. The

following image illustrates how this will appear.

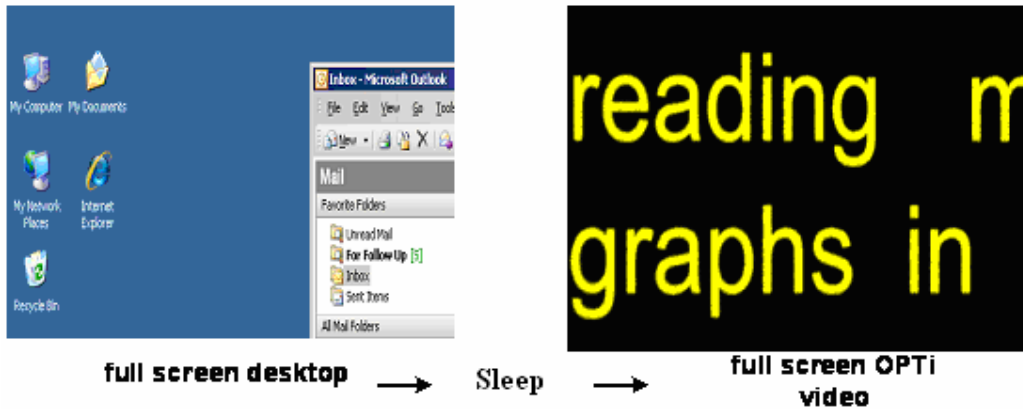

The toolbar is hidden in fullscreen mode although the user can use the hotkey functions or unit buttons to operate the OPTI.



To swap between the OPTi video and the desktop you simply press the **Sleep** button/hotkey (Page 12)

OPTi Sounds

This version of OPTi software is able to make sounds to indicate when it is the active application. The purpose behind this is to give an audible indication when you press the **Scroll-Lock** of whether you are

making OPTi the active application or not. There are two different types of sound available depending on the state of **“Use external speakers for OPTi sounds”** checkbox in the Preferences → Advanced menu.

If this box is ticked, then OPTi will use any external speakers you have connected to emit a double note when you press Scroll-Lock and make it the active application, and a single note when you press Scroll-Lock and stop OPTi from being the active application. This setting is useful for a desktop PC with no internal speaker to make sounds.

If this box is not ticked OPTi will use the internal speaker on your computer. In this case OPTi will emit a “Buh – Dee” note when OPTi is being made the active application and a “Dee – Buh” note when OPTi is no longer the active application. This setting is useful for a portable laptop computer with no external speakers hooked in.

Looking at the Advanced menu in the image below, the two settings related to OPTi sounds are circled in red.

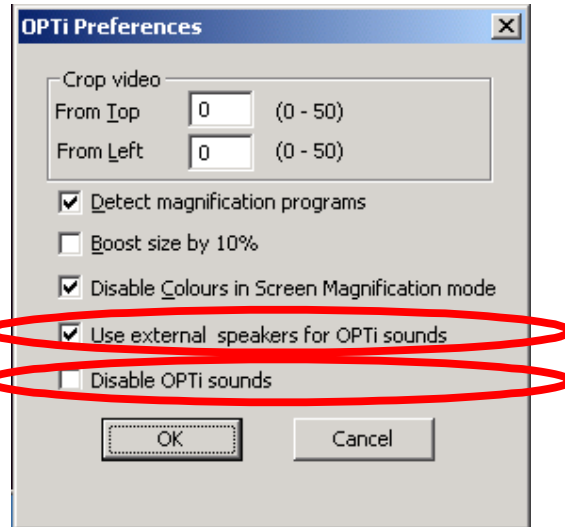

OPTi Preferences → Advanced menu

The second checkbox simply stop's OPTi from making any sounds at all regardless of what state the **“Use external speakers for OPTi sounds”** checkbox is in.

Adjusting the Magnification

The magnification is determined by the height of the camera above the reading

material. The best way to adjust this is to place one hand firmly on the tabletop, and raise or lower the camera with your other hand as in the diagram below.

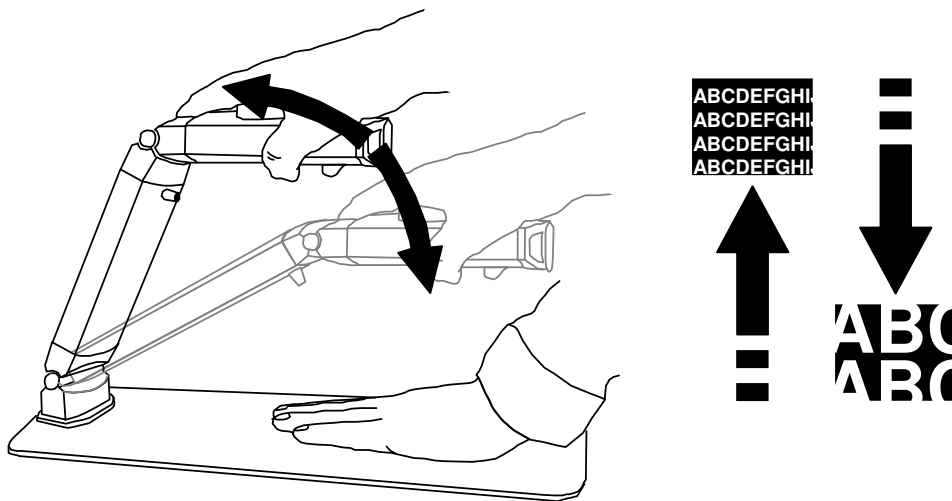

Lower the camera for higher magnification; raise it to reduce the magnification.

Use the lowest magnification you are comfortable with because:

It is easier to locate your position on the page;

There is less need to move a book on the table;

The focus will work over a greater depth.

Adjusting the Focus

If you change the height of the camera, or if the thickness of the material being read is changed, you will need to re-focus the camera. Rotate the focus control on the top of the unit until the image is at its sharpest. The direction of rotation is unimportant.

Reading with OPTi Lite

Place the material you wish to read on the reading table and adjust the focus knob until a sharp image is obtained. Adjust the magnification as described above to suit and re-focus if necessary. Ensure the camera head is horizontal for optimum image quality.

Move the book on the table until you locate the top of the page and then locate the start of the text. Simply slide the book side to side and watch the computer screen while reading.

There is a mat provided with your OPTi Lite to facilitate reading heavier materials. Place the mat across the reading table with the rubber side upwards. Place the book on the mat and slide the mat from side to side.

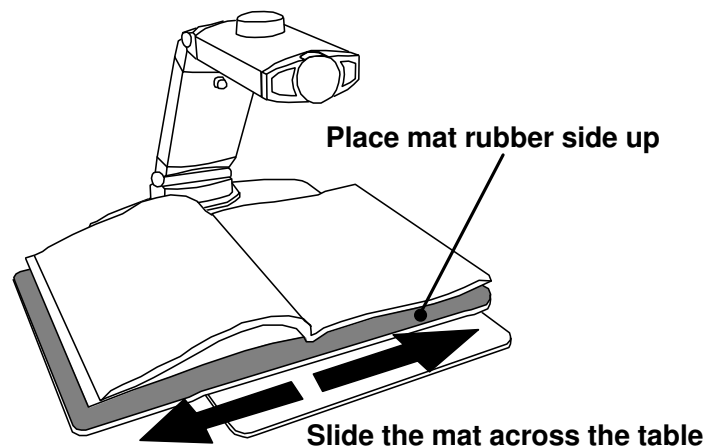

Writing

Remove the mat from the table. Place the page under the camera and locate the area of the page where you wish to start writing. Holding the page firmly, bring your pen, raised well above the paper, until the nib is visible on the screen at the point you wish to write. Lower the pen to the paper carefully and write. You should watch the screen as you write.

Hints and Tips

Locating the OPTi Lite camera in a well-lit area will enhance the image available from the unit. If possible, avoid direct overhead lighting as this can cause shadows on the page leading to shading differences on the screen.

If you require subdued lighting, you should switch on the lights, otherwise the picture will become noisy.

When using glossy paper, tilt the camera head upwards slowly until the reflections move off the screen.

Taking Care of your OPTi Lite

Do not touch the lens. Dirt on the lens will appear as a blurred or dim image or as fuzzy spots on the screen. If you believe the lens is dirty, it can be cleaned with a **soft**, dry cloth applying minimal pressure. As the lens is polished and coated, do **not** use a wet or coarse cloth, detergents, abrasive substances or solvents to clean it.

When transporting the unit we recommend that you use the carrying case provided. Do not allow the charger or cables to move about within the case, as they may cause damage.

Warranty

Ash Technologies warrants the equipment, when purchased new, to be free from defects in material and workmanship and will repair or replace at Ash Technologies' discretion, any equipment which exhibits such defects, provided that the equipment has been operated under the proper conditions of installation and has not been tampered with by any persons not authorized by Ash Technologies or its agents and that it is solely serviced by Ash Technologies or its agents. This warranty shall be voided in the event of damage or abuse to the unit caused, in the opinion of Ash Technologies or its agents, by general wear and tear, abuse, neglect, failure to observe stated precautions or by dropping the unit.

Batteries are warranted for failure within a period of one year. Non-electrical accessories are specifically excluded from warranty.

In no event shall Ash Technologies, or its agents, be liable for special, indirect, incidental or consequential damages; the original user's remedies being limited to repair or replacement.

Ash Technologies makes no other or further warranty, express or implied, including and warranty of fitness for a specific purpose or warranty of merchantability.

This warranty is valid for a period of TWO YEARS effective from the date of delivery to the customer.

Depending on the country of sale, the warranty conditions may differ. Contact your distributor for details.

For warranty claims or service during or after warranty period please contact your distributor.

DECLARATION OF CONFORMITY

We, **Ash Technologies Ltd.**, declare under our sole responsibility that this product, **OPTi Lite**, of the brand **Ash Technologies** to which this declaration relates, is in conformity with the following standards or other normative documents:

EN 60601-1 Medical Electrical Equipment - Safety

EN 60601-1-2:2001 Medical Electrical Equipment – Electromagnetic
Compatibility

Following the provisions of EMC directive 89/336/EEC and Low Voltage directive 73/23/EEC and the provisions of 93/42/EEC Medical electrical equipment directive.

Alan Johnston
Engineering Director
Ash Technologies Ltd, Naas, Ireland.
24th April 2006



This page is deliberately left blank

This page is deliberately left blank

OPTi Lite User Manual
Revision 1.02 English



<p>Ash B5, M7 Business Park Naas, Ireland. Made in Ireland</p>	<p> +353-45-88 22 12  +353-45-88 22 14 email: info@ashtech.ie web: www.ashtech.ie</p>
----------------------------------------------------------------------------	--------------------------------------------------------------------------------------------------------------------------------------------------------------------------------------------------------------------------------------------------------------------------------------------------------------------------------------------------

© Ash Technologies, 2006