

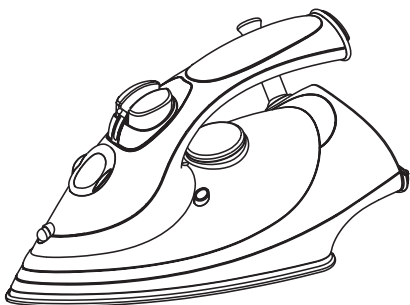

Multi-purpose iron

Model: G-896STJ



Instruction Manual

IMPORTANT SAFEGUARDS

1. Make sure to read all the safety precautions below and look at the illustrations before you start using the appliance.
2. Use the appliance for its intended use only described in this manual.
3. The appliance is intended for household use only.
4. In order to protect against the risk of electric short, do not immerse iron power base into water or any other liquids.
5. Connect the appliance only to an alternating current of the voltage specified on the rating plate and only to an earthed socket. To avoid a circuit overload, do not operate another high wattage appliance in the same circuit.
6. Turn the appliance to OFF before plugging or unplugging from outlet. Never yank cord to disconnect from outlet; instead, grasp plug and pull to disconnect.

7. Do not allow power cord or supply hose to touch hot surface.
8. Unplug the appliance from main socket before filling or empty or when not in use.
9. Do not operate the appliance with a damaged cord or if the appliance has been dropped or damaged. To avoid a hazard such as the risk of electric shock, do not disassemble the appliance, it must be taken to a qualified serviceman or manufacturer or its service agent for examination and repair. Incorrect re-assembly can cause a risk of electric shock when the iron is used.
10. Place the iron out of reach of children; close supervision is necessary for any appliance being used by or near children. Do not leave the iron unattended while connected to the supply mains.
11. During use, always place its stand on a stable, level and horizontal surface or ironing board.

12. Always place the iron on its stand, and do not allow the hot soleplate touch power cord or supply hose.
13. Burns can occur from touching hot metal parts, hot water or steam. Use caution when using the appliance.
14. Never use the iron facing towards people because the steam can cause burns.
15.  The surfaces are liable to get hot during use.
16. Never twist the supply hose during use.
17. The appliance must be used and rested on a stable, level and horizontal surface.
18. When placing the iron on its stand, ensure that the surface on which the stand is placed is stable.
29. The iron is not to be used if it has been dropped, if there are visible signs of damage or if it is leaking.
20. The iron must not be left unattended while it is connected to the supply mains.

21. The appliance must be rest or stocked on a stable, level and horizontal surface.
22. This appliance can be used by children aged from 8 years and above and persons with reduced physical, sensory or mental capabilities or lack of experience and knowledge if they have been given supervision or instruction concerning use of the appliance in a safe way and understand the hazards involved, children shall not play with the appliance. cleaning and user maintenance shall not be made by children without supervision.
23. Keep the iron and its cord out of reach of children less then 8 years of age when it is energized or cooling down.

Parts and Features:

- ① Self cleaning button
- ② Soleplate
- ③ Spray nozzle
- ④ Anti-calc box
- ⑤ Adjustable steam knob
- ⑥ Spray button
- ⑦ Turbo steam button
- ⑧ Temperature control dial
- ⑨ Cord guard
- ⑩ Power indicator light

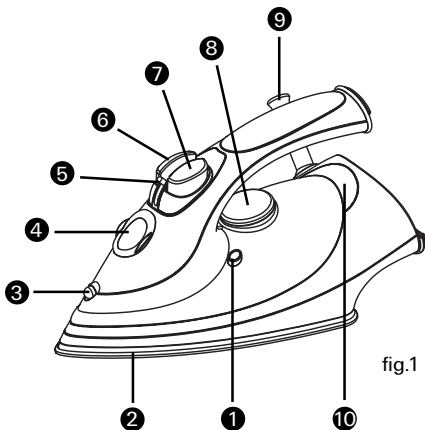



fig.1

Fabric Setting Chart

Temperature Setting	Min	● (Low)	▬▬ (Medium)	▬▬▬ (High)	☁ (Max)
Fabric		Synthetics, silk, Nylon, Acrylic, Acetate	Wool, Polyester	Rayon Cotton, Linen	Rayon Cotton, Linen
Iron Instructions	Shut off	Dry Ironing on the opposite side of the fabric	Use a press cloth and steam or dry ironing on the opposite side of the fabric	Iron while fabric is still damp using steam and spray	Steam ironing

Fill Water Tank

Make sure that the iron is unplugged from main socket before filling water into the water tank.

1. Set the adjustable steam knob to "  "position. (Fig.2)
2. Take anti-calc box out of the filling hole. (Fig. 3)
3. Using a cup, slowly pour tap water or distilled water into the water tank as shown in Fig.4 . Never to fill beyond the Max filling line.
4. Replace the anti-calc box into the filling hole as shown in Fig.5 .
5. Hold the iron in horizontal direction, and then move the iron from front to back for about 30 seconds so that limescales in water can be purified by Ion

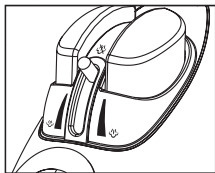

fig.2

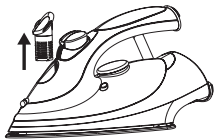

fig.3

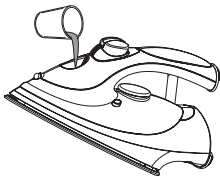

fig.4

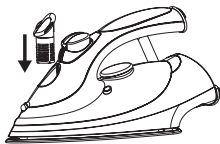

fig.5

Note: When using distilled water, you can mix it with tap water in a proportion of 50%.

exchange resin in the anti-calc box.

Steam ironing

1. Place the iron on a horizontal, plain ironing board
2. Set the adjustable steam knob to " " position, and then fill the water tank with clean tap water refer to above filling instruction.
3. Connect the appliance to a suitable socket outlet, turn the temperature control dial to " " position. The power indicator light will turn on to indicate the unit being heated up. It will go out when the required temperature is reached, During this stage, it is normal that a "pong" sound provided, which indicate that the steam switch automatically turn on.
4. When setting the temperature control dial at " " or " " position, anti-drip function will automatically react due to the temperature decrease so low that no steam will be produced.
5. For every first use, press down the turbo steam button several times, and then press down the self-cleaning button for about 10seconds to clean the steam chamber.
6. Turn temperature control dial to desired position according to different fabrics, put the adjustable steam knob to " " position, and then steam will come out from steam vents of soleplate. During steaming iron, it is normal that the indicator light cycle from on to off and then off to on. It is because the appliance is automatically heat preservation.
7. After use, turn the temperature control dial to "Min" position, and put adjustable steam knob to " " position, then disconnect the appliance from main socket.
8. Place the iron on its rest for completely cooling down.

Note: 1. For every first use, the appliance should be pre-heated for about 2 minutes.

2. When setting the temperature control dial at " " or " " position, there are no steam go out of the soleplate since the temperature of soleplate is so low that it can not produce steam.



Dry Ironing

1. Place the iron on a level, horizontal ironing board
2. Set the adjustable steam knob to " " position, and then fill the water tank with clean tap water refer to above filling instruction.
3. Connect the appliance to suitable main socket, and then turn temperature control dial to the desired position according to different fabrics. The indicator light will light up to indicate the unit start being heated up.
4. The indicator light will go out when the required temperature is reached and the unit is ready for dry ironing.
5. If water spray is necessary, press down the spray button two or three times in quick succession, water can be sprayed evenly in the fabric.
6. After use, turn the temperature control dial to "Min" position, and then disconnect the appliance from main socket.
7. Place the unit on its rest for completely cooling down.

Note: When changing your temperature control dial from high setting to lower, it is proposed that not to start ironing immediately since there may be any burns caused on your fabrics by high temperature. Please wait for the indicator light light up again and then start ironing.

Turbo Steam Ironing

Turbo Steam feature provides additional steam for removing stubborn creases

1. Set the "adjustable steam knob" to " " position, and then fill the water tank with clean tap water refer to above filling instruction.
2. Connect  appliance to a suitable socket outlet, turn the temperature control dial to " " position. The power indicator light will light up to indicate the unit being heated up. It will go out when the required temperature is reached
3. Press the turbo steam button two or three times in quick succession to obtain more powerful turbo steam.
4. It is normal that a small amount of water may be ejected from the soleplate when pressing down turbo steam button so frequently that temperature of soleplate will be decreased accordingly. It is supposed to stop pressing turbo steam button, and allow it to heat up again.
5. Before storing ,allow the unit completely cool down. 

Caution: when using turbo steam ironing, set adjustable steam knob to " " position.

Vertical steam ironing:

Follow the steam ironing process, and then hold the iron in vertical position between 15cm away from the hanged fabrics. (Fig.6) Press the steam button, this will create vertical steam. This feature is especially used for removing creases from hanging clothes and curtains. Never perform steam ironing directly on person.

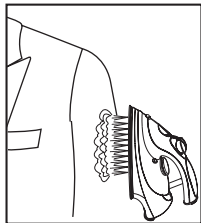

fig.6

Anti-drip system:

This appliance has a safety mechanical protection which can protect water drip from the soleplate when the temperature of steam chamber is so low that it cannot provide steam..

Anti-calc system:

1. The anti-calc box is designed to purify hard water and reduce the build-up of limescale which occurs during steam ironing, this will prolong the working life of your iron.
2. The anti-calc box should be replaced with a new one after two months, in case of using one time each day, and you can contact with manufacturer or agency for purchasing a new one)
3. To replace the anti-calc box, take the anti-calc box out of the water filling hole and replace with a new one. (Fig.7)



Fig.7

Maintenance:

After several use of your iron, a little amount of limescale will be built up in the steam chamber and steam outlet, following up below self-cleaning process, it will be well removed.

1. Set the adjustable steam knob to "☞" position.
2. Fill water tank with water to max filling line.
3. Place the iron on the ironing rest, and place a sink under the ironing rest to prepare for pouring water and ejecting steam.
4. Set temperature control dial to "☹☹☹" position.
5. Plug the unit into the main socket.
6. Allow the iron to heat up for 2 minutes
7. Disconnect the iron from main socket.
8. Hold the iron horizontally over the sink.
9. Push the self-cleaning button. (Fig.8)
10. Boiling water and steam will emit from the outlet of the soleplate and wash away the impurities and scale.
11. Move the iron backwards and forwards while this happens. Go on letting steam and water escape until the water tank is virtually empty.
12. Insert the iron into main socket again.
13. Set the temperature control dial to "☹☹☹" position, Let the iron heat up again. The remainder of the water inside the steam chamber will now vaporize.
14. Unplug from power supply and allow soleplate to cool down and wipe it clean with a soft damp cloth.

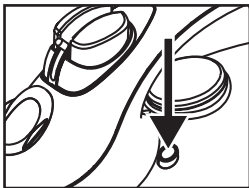

fig.8

Note: Never use scouring pads, abrasive or harsh cleaners as this may scratch the surface.



Never dispose of your product with other household waste. Please inform yourself about the local rules on the separate collection of electrical and electronic products. The correct disposal of your old product helps prevent potentially negative consequences on the environment and human health.

