

# WR-2A

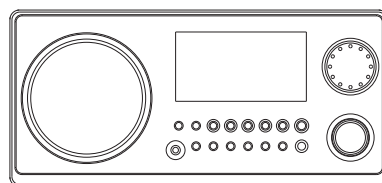

**GB**

Revision 1

## Important Safety Instructions

1. Read these instructions.
2. Keep these instructions.
3. Heed all warnings.
4. Follow all instructions.
5. Do not use this apparatus near water.
6. Clean only with dry cloth.
7. Do not block any ventilation openings. Install in accordance with the manufacturer's instructions.
8. Do not install near any heat sources such as radiators, heat registers, stoves, or other apparatus (including amplifiers) that produce heat.
9. Do not defeat the safety purpose of the polarized or grounding-type plug. A polarized plug has two blades with one wider than the other. A grounding type plug has two blades and a third grounding prong. The wide blade or the third prong are provided for your safety. If the provided plug does not fit into your outlet, consult an electrician for replacement of the obsolete outlet.
10. Protect the power cord from being walked on or pinched particularly at plugs, convenience receptacles, and the point where they exit from the apparatus.
11. Only use attachments/accessories specified by the manufacturer.



12. Use only with the cart, stand, tripod, bracket, or table specified by the manufacturer, or sold with the apparatus. When a cart is used, use caution when moving the cart/apparatus combination to avoid injury from tip-over.
13. Unplug this apparatus during lightning storms or when unused for long periods of time.
14. Refer all servicing to qualified service personnel. Servicing is required when the apparatus has been damaged in any way, such as power-supply cord or plug is damaged, liquid has been spilled or objects have fallen into the apparatus, the apparatus has been exposed to rain or moisture, does not operate normally, or has been dropped.
15. To Reduce the Risk of Fire or Electric Shock, Do not Expose This Appliance To Rain or Moisture.
16. The Shock Hazard Marking and Associated Graphical Symbol is provided on the bottom panel of unit.
17. Apparatus shall not be exposed to dripping or splashing and no objects filled with liquids, shall be placed on the apparatus.
18. Excessive sound pressure on ear- and headphones could impair the hearing ability. Higher setting that idle on the equalizer leads to higher signal voltages on the output for ear and headphones.
19. The power plug should be close to the radio, and easy to be approached that during the emergency, to disconnect the power from the radio, just unplug the power plug from the AC power slot.
20. Where the MAINS plug or an appliance coupler is used as the disconnect device, the disconnected.

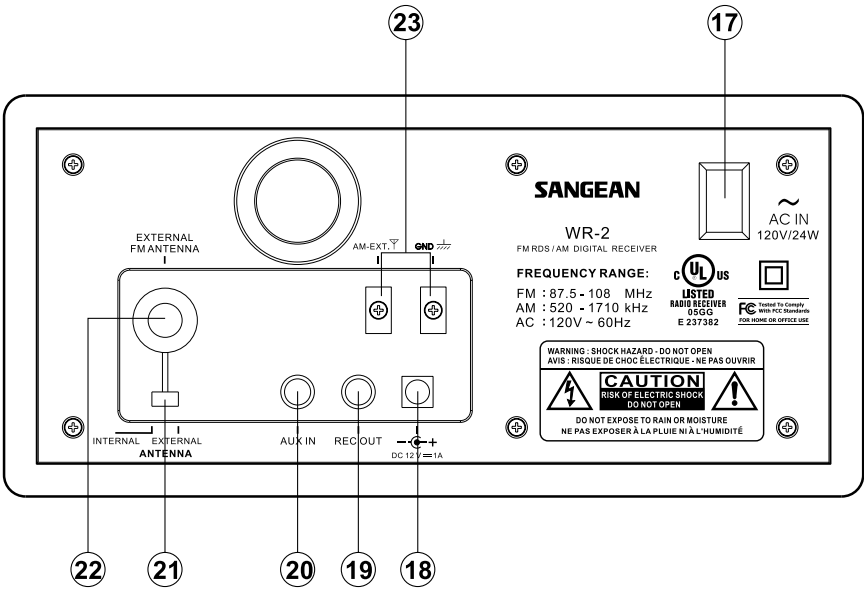
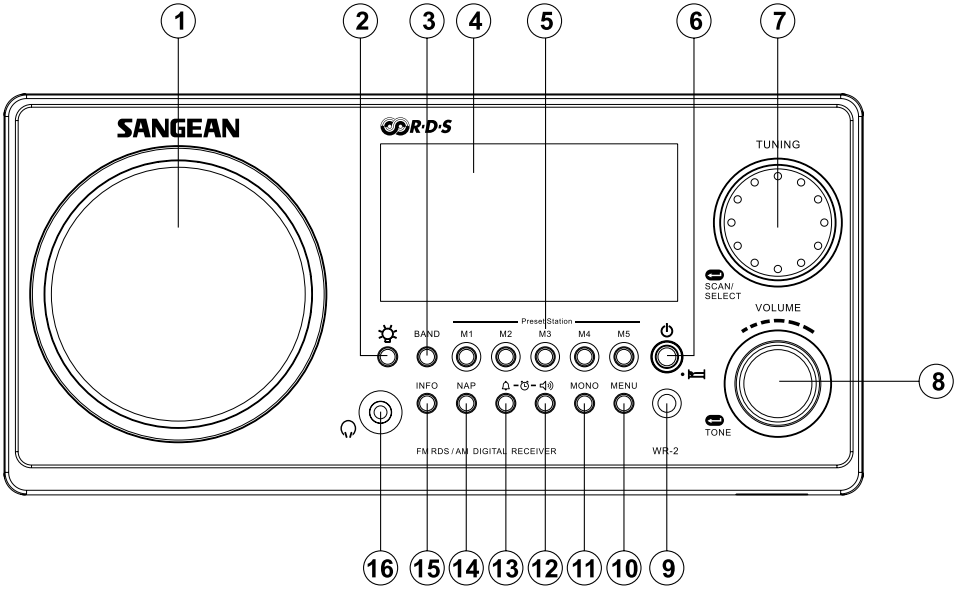

# Controls

GB

- ① Speaker
- ② Light button
- ③ Band button
- ④ LCD display
- ⑤ Preset buttons
- ⑥ Power On / Off / Sleep button
- ⑦ Tuning control knob
- ⑧ Volume / tone control
- ⑨ IR sensor
- ⑩ Menu button
- ⑪ Mono button
- ⑫ Radio alarm button
- ⑬ Buzzer alarm button
- ⑭ Nap button
- ⑮ Info button
- ⑯ Headphone socket
- ⑰ AC power cord socket
- ⑱ 12V DC input socket (ideal for vehicles / boats)
- ⑲ REC out socket
- ⑳ AUX IN socket
- ㉑ External / Internal antenna switch
- ㉒ External F-type FM antenna terminal
- ㉓ External AM antenna terminal (USA version only)

# Remote control

- (a) Power On / Off / Sleep button
- (b) Nap button
- (c) Select button
- (d) Info button
- (e) Preset button
- (f) Mute button
- (g) Light button
- (h) Tuning up / down button
- (i) Tone control button
- (j) Volume button
- (k) Menu button
- (l) Radio alarm button
- (m) Buzzer alarm button
- (n) Band button

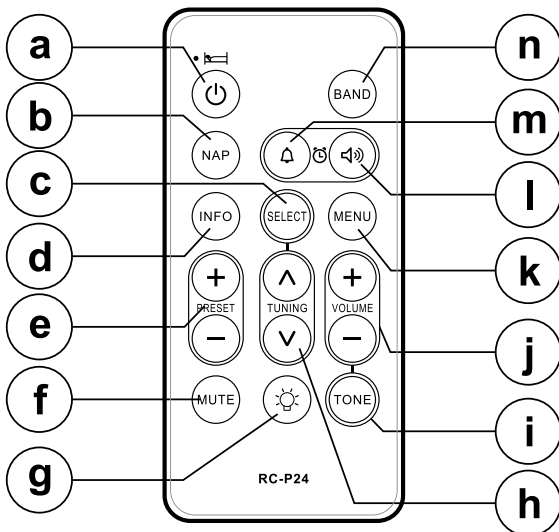

# Display icons

- Ⓐ Frequency / Time / Station display
- Ⓑ Radio / Buzzer alarm indicator
- Ⓒ Daylight Saving Time (DST)
- Ⓓ Sleep / Snooze status
- Ⓔ RDS indicator
- Ⓕ Stereo indicator
- Ⓖ Memory preset
- Ⓗ Aux In level attenuation

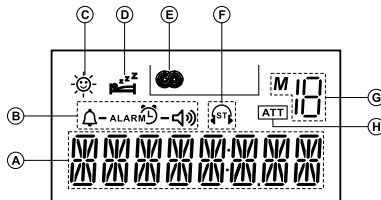

## Remote control functions

Many functions of the WR-2 radio can be operated using the remote control. Some operations require a longer press of the button.

In this case simply keep your finger held on the remote control button for 2-3 seconds until the display on the radio shows that the command has been accepted.

**Before the first operation: please remove the small transparent foil from the battery holder to activate the battery.**



## Remote control battery replacement

1. Open the battery holder by pulling the holder out in direction shown.
2. Remove battery from holder.
3. Replace battery (CR2025 or equivalent) ensuring that the positive side of the battery faces you with holder positioned as shown.
4. Replace the battery holder.

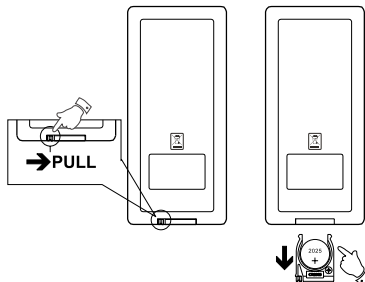

GB

### **IMPORTANT:**

The batteries should not be exposed to excessive heat such as sunshine, fire or the like. After use, disposable batteries should if possible be taken to a suitable recycling center. On no account should batteries be disposed of by incineration.



### **Warning**

#### KEEP OUT OF REACH OF CHILDREN

[The remote control supplied with] This product contains a coin/button cell battery. Swallowing may lead to serious injury or death. Severe burns can occur within 2 hours of ingestion.

Keep batteries out of reach of small children. Coin cell batteries can be accidentally ingested. If ingested, these batteries may leak harmful contents causing chemical burns, perforation of soft tissue, and in severe cases may cause death. Coin batteries must be removed immediately if swallowed. Seek medical attention immediately, if you or your doctor suspects that a battery has been ingested.

## Power your radio

### AC operation

Before you plug the AC cord into the radio, be sure the AC voltage is correct. Insert the plug on the end of the supplied power cord into the AC power socket on the back of the radio.

### DC operation

For outdoors use, you can power the radio by using 12V DC input socket from a DC power supply (example, from the power supply of vehicles or boats). An AC power adaptor with 1 Ampere and center positive in polarity can also power the radio in house.

## Using the radio for the first time

1. Place your clock radio on a flat surface.
2. Insert the adaptor plug into the AC socket located on the rear of your radio.

## Manual clock setting



1. Press Menu button and the display will show 'CLOCK SET'.
2. Press the Tuning control knob to enter the clock setting.
3. Rotate the Tuning control knob to select the desired hour and press the Tuning control knob to confirm the hour setting. Now the minute digit will flash.
4. Rotate the Tuning control knob to adjust the minutes and press the knob to confirm the setting. Now the clock setting is completed.

## Auto clock setting

GB

### a. Radio data system (RDS)

When you set the clock time using the RDS function, your radio will synchronize its clock time whenever it tunes to a radio station using RDS with CT signals.

1. When tuning to a station transmitting RDS data, press the Menu button.
2. Rotate the Tuning control knob until a clock symbol  appears on the display. Press the Tuning control knob to enter the setting.
3. Rotate the Tuning control knob until RDS CT (or 'RBDS CT' in the US ) appears on the display. Press the Tuning control knob to confirm the setting. The clock time of the radio will set up automatically according to the RDS data received.
4. When the action is completed, you can put your radio in standby mode, the RDS icon  will appear on the LCD display indicating the radio time is RDS clock time. The radio clock time will be valid for 24hours each time the radio time is synchronized with RDS CT.

### Note:

RDS service is mainly available in Europe (including UK) and part of Northern America plus some of Asian countries only.

## **b. Manual (if your don't want to synchronized clock time with RDS CT)**

When choosing manual setting as the clock time setting of your radio, Radio Data System (RDS) function will both be disabled.

1. Press the Menu button.
2. Rotate the Tuning control knob until a clock symbol  appears on the left side of the display, then press the Tuning control knob to enter the setting. Rotate the Tuning control knob until 'MANUAL' appeared on the display, then press the Tuning control knob to select the setting.
3. Then follow the steps described in the section of 'Manual clock setting' to set the clock time manually.

## **Change 12/24 hour clock format**

1. Press the Menu button to enter the setting.
2. Rotate the Tuning control knob until 'CLOCK 24H' is highlighted on the display. Press the Tuning control knob to enter the setting.
3. Rotate the Tuning control knob to choose 12/24 hour clock format. Press the Tuning control knob to confirm the setting.

## Date setting

1. Press the Menu button to enter the setting.
2. Rotate the Tuning control knob until 'DATE SET' is highlighted on the display. Press the Tuning control knob to enter the setting.
3. Rotate the Tuning control knob to select the desired year and press the knob to confirm the setting.
4. The month digit will flash on the display. Rotate the Tuning control knob to select the desired month and press the knob to confirm the setting.
5. The date digit will flash on the display. Rotate the Tuning control knob to select the desired date and press the knob to confirm the setting. Now the date setting is completed.

GB

## Change date format

1. Press the Menu button to enter the setting.
2. Rotate the Tuning control knob until date format (e.g. May 17 FR) is highlighted on the display. Press the Tuning control knob to enter the setting.
3. Rotate the Tuning control knob to choose your desired format. Press the Tuning control knob to confirm the setting.

## **D.S.T (Daylight Saving Time)**

1. Press the Menu button to enter the menu setting.
2. Rotate the Tuning control knob until 'DST OFF' is appeared on the display. Press the Tuning control knob to enter the setting.
3. Rotate the Tuning control knob to choose '+1H' (activated D.S.T.) or 'OFF'. Then press the Tuning control knob to confirm the setting.

## **Antenna setup for FM reception**

The radio comes with built-in AM/FM antenna and external antenna.

To use FM internal antenna, make sure to switch FM external/internal antenna switch in the back of your radio to internal antenna position (i.e. INT. FM ANTENNA). As for external antenna, you can use to improve FM reception. Two types of antenna can be used. You can connect the supplied FM wire antenna to the F-type antenna terminal and adjust the wire for best reception.

You can also connect a 75 ohm coaxial cable of outdoor antenna to the terminal. Make sure to switch external/internal antenna switch to external position while using the supplied wire antenna or connecting the outdoor antenna. In some of the European countries, you may have to connect the supplied antenna terminal adaptor to connect with the outdoor antenna.

## Antenna setup for AM reception

The radio comes with built-in AM antenna which should be enough for normal listening. To improve the AM reception, you may connect the outdoor AM antenna with AM external antenna terminal (USA version only).

GB

## Operating your radio

Your radio is equipped with three tuning methods – Scan tuning, manual tuning and Memory preset tuning.

### A. Manual tuning

1. Press the Power button to turn on your radio.
2. Press the Band button repeatedly to select AM (MW) or FM waveband.
3. Rotate the Tuning control knob to change the frequency.

### B. Scan tuning

1. Press the power button to turn on your radio.
2. Select the required waveband by repeatedly pressing the Band button.
3. Press and hold Tuning control knob, your radio will scan the selected waveband and stop automatically when it finds a station of sufficient strength.
4. Set volume control and tone control to the desired setting (volume and tone control setting will be described later).
5. To switch off your radio, press Power button.

## **C. Presetting and recalling stations**

### **Presetting stations:**

1. Press the Power button to turn on your radio.
2. Press the Band button repeatedly to select AM (MW) or FM waveband.
3. Tune into the station that you would like to preset following the steps above.
4. There are 5 preset buttons from 1 to 5. Press and hold one of preset buttons until the radio beeps, and the station frequency will be saved into the chosen preset.
5. Repeat the procedure for the remaining presets. Your radio has 5 presets for each AM and FM.
6. The preset can be overwritten by following the above steps.

### **Recalling stations:**

1. Press the Band button for AM or FM.
2. Press and release one of the Preset buttons (from 1 to 5) and the preset number and frequency will appear on the display.



## Setting up the tuning step increment

1. Press the Menu button to enter the setting.
2. Rotate the Tuning control knob until FM xxkHz or AM xxkHz appears on the display, and press the knob to enter the step increment setting.
3. Rotate the Tuning control knob to select 50kHz/100kHz for FM radio, and 9kHz/10kHz for AM radio. Then press the Tuning control knob to confirm the setting.

GB

## Volume and Tone control

1. Rotate the volume control knob to set the required volume level, display will show volume level (maximum to 30)
2. Press Volume control once to get into treble control. Rotary the control until required treble is reached.
3. Press Volume control twice to get into bass control. Rotary the control until required bass is reached.

## FM Stereo / Mono button

1. If a station being received is weak, some hiss may be audible. To reduce the hiss, press Mono button and stereo icon will disappear on the display.
2. Press the Mono button to return to Stereo operation.

**Note:** FM stereo is only available when using headphones.

## Display modes - FM

Your radio has a range of display options for FM radio mode.

1. Repeatedly press and release the Info button to view the RDS information of the station you are listening to.
  - a. Station name      Displays the name of the station being listened to.
  - b. Program type      Displays the type of station being listened to such as Pop, Classic, News, etc.
  - c. Radio text      Displays radio text messages such as new items etc.
  - d. Year / Day      Displays the year and day of the week according to the date setting of your radio.
  - e. Date / Day      Displays the date and day of the week according to the date setting of your radio.
  - f. Time      Display the time according to the time setting of your radio.
  - g. Frequency      Displays the frequency of the FM for the station listened to.

If there is no RDS data available (or if the signal is too weak) then the radio will display only the FM frequency.

## Alarm setting

GB

There are two alarms which can each be set to wake you to AM/FM radio or buzzer alarm. The alarms may be set while the unit is in standby mode or while playing. When the alarm light is on, it means the indicated alarm will active in 24 hours. Ensure that the time is set correctly before setting the alarms.

### Note:

Alarm setting can be done only when time setting is completed. Alarm can be operated when radio is on or off. Setting via remote control is the same.

### a. Wake to radio alarm

1. Before setting an alarm ensure the clock time is set. To enter the alarm setting, press and hold radio alarm button (  ) until your radio beeps.
2. The hour setting will begin to flash. Rotate the Tuning control knob to select the required alarm hour, and press the Tuning control knob to confirm the setting. Rotate the Tuning control knob to select the required alarm minute, and press the Tuning control knob to confirm the setting.

3. Then the display will show the frequency options for the alarm. Rotate the Tuning control knob to select the desired option and press the control knob to confirm the setting.



The alarm options are as follows:

ONCE – the alarm will sound once

DAILY – the alarm will sound everyday

WEEKDAY – the alarm will sound only on weekdays

WEEKEND – the alarm will sound only at weekends

4. Rotate the Tuning control knob to choose the required alarm type, and then press the Tuning control knob to confirm the setting. The alarm can be set to FM or AM. When radio type is selected, the radio frequency on the display will begin to flash. Rotate the Tuning control knob to adjust the required radio frequency or press the corresponding preset button as desired for the radio alarm, then press the Tuning control knob to confirm the setting.
5. Rotate the Tuning control knob to select the required alarm volume and press Tuning control knob to confirm the setting. The alarm has now been set. Symbol for active alarm ( **ALARM**  -  ) is shown on the display.

## b. Wake to buzzer alarm

1. Before setting an alarm ensure the clock time is set. To enter the alarm setting, press and hold buzzer alarm button (  ) until your radio beeps.
2. The hour setting will begin to flash. Rotate the Tuning control knob to select the required alarm hour, and press the Tuning control knob to confirm the setting. Rotate the Tuning control knob to select the required alarm minute, and press the Tuning control knob to confirm the setting.
3. Then the display will show the frequency options for the alarm. Rotate the Tuning control knob to select the desired option and press the Tuning control knob to confirm the setting.

The alarm options are as follows:

ONCE – the alarm will sound once

DAILY – the alarm will sound everyday

WEEKDAY – the alarm will sound only on weekdays

WEEKEND – the alarm will sound only at weekends

4. Rotate the Tuning control knob to select the required alarm volume and press Tuning control knob to confirm the setting. The alarm has now been set. Symbol for active alarm (  ) is shown on the display.

## **When the alarm sounds**

When the buzzer alarm activates, the alarm will start softly and gradually increase in level. It will sound for 1 minute and silence for 1 minute in repetition for 60 minutes unless cancelled. When the other alarm types are set, the radio will sound non-stop at the selected time for up to 60 minutes.

When the radio alarm is activated, the alarm will go off in Humane Waking System. It will increase its volume in 0.5 increments from 0 to your set volume.

To deactivate a sounding alarm, press the Power button to cancel a sounding alarm.

## **Disabling / cancelling alarm setting**

To cancel the alarm setting, press and hold the corresponding alarm button before the alarms sound off.



## Snooze

1. When the alarm sounds, press any button other than the Power button will silence the alarm for 5 minutes. “” will appear on the display.
2. To adjust the silence time for the snooze timer, press the Menu button to enter the menu setting.
3. Rotate the Tuning control knob until “SNOOZE X” shown on the display, then press the Tuning control knob to enter the setting. Rotate the Tuning control knob to adjust the silence time. There are 5, 10, 15 and 20 minutes for the snooze timer. Press the Tuning control knob to confirm the setting.
4. To cancel the snooze timer while the alarm is suspended, press the Power button.

GB

## Sleep timer - radio auto shut off

Your radio can be set to turn off automatically after a preset time has elapsed. The Sleep Timer setting can be adjusted between 15,30, 45, 60, 90 and 120 minutes.

1. Press and hold the Standby button to enter the Sleep Timer setting. “SLEEP XX” will show on the display. The display will cycle through the available sleep times in the order of 60-45-30-15-120-90-60. Release the button until the desired SleepTimer setting appears on the display. The setting will be saved and the  symbol will be shown on the display.
2. To cancel the Sleep Timer function before the preset time has elapsed, simply press and release the Standby button to turn the unit off manually. The  symbol will disappear on the display.

## Display backlight



To turn on display illumination, press and release Light button (  ). By pressing and releasing Light button, you may also adjust display brightness or turn off the illumination completely.

## Nap timer

1. Press the Nap timer button to enter the menu setting. Keep holding the Nap timer button and the options will show on the display from 5 to 120 minutes. Stop until the required Nap Timer setting appears on the display. The setting will be saved and the LCD will return to normal display. After 10 seconds, the display will show the countdown of the nap time..
2. To cancel a sounding Nap timer, press Power button. If any button other than the Power button is pressed when the alarm sounds, snooze function will be activated. To cancel the function when countdown is progressing, go to nap timer setting menu and select 'OFF'.

## Software version

The software display cannot be altered and is just for your reference.

1. Press Menu button to enter the menu setting.
2. Rotate the Tuning control knob until "VER XX" appears on the display to view the software version of your radio.



## Loudness

You can get compensation on lower and higher frequency for your radio by adjusting the Loudness function.

GB

1. Press the Menu button to enter the menu setting.
2. Rotate the Tuning control knob until 'LOUD ON or OFF' appears on the display. Press the Tuning control knob to enter the setting.
3. Rotate the Tuning control knob to choose ON to turn on the loudness function, then press the Tuning control knob to confirm the setting.
4. To turn off the loudness function, select OFF and press the Tuning control knob to confirm the setting.

## AUX IN socket

On the rear of your radio is to allow signal from external device e.g. CD player to be fed into your radio and playback of the external device via your radio amplifier.

Inserting a plug into the AUX IN will not mute the radio signal, however you have to repeatedly press the Band button until display shows 'AUX IN'.

## AUX IN input level attenuation

The input level attenuation is to allow input level reduction once the signal from external device is too strong.

**Note:** remote control unit is not applicable for this operation.

1. Press Band button to select Aux in mode.
2. Press Menu button to enter the setting list.
3. Rotate the Tuning control knob until “ATT ON” shown on the display. Press the Tuning control knob to enter the setting.
4. Rotate the Tuning control knob to select attenuation on or off. If ‘ON’ is selected, display will show ATT symbol indicating the input signal has been attenuated.

## REC OUT socket

On the rear of your radio is for use with a tape recording/mini disc or to allow connection to line input of a Hi-Fi system. The signal on the Record out socket is unaffected by the volume control.

## Headphone use

Headphone use with this radio should be fitted with a 3.5 mm jack plug. Insert the headphones plug into the jack in the front of the radio. When the headphones are plugged in, the loudspeaker is automatically disconnected.

GB

### ***IMPORTANT:***

Excessive sound pressure from earphones and headphones can cause hearing loss.

## Mute the radio

Press MUTE button on the remote control to mute the radio.

Press MUTE button again or power on/off or volume control to release the muting.

## Factory reset

If your radio fails to operate correctly, or some digits on the display are missing/incomplete or you simply just want to restore to original factory setting, carry out the following procedure.

1. Press the Menu button to enter the menu setting.
2. Rotate the Tuning control knob until “FACTORY RESET” shown on the display. Press the Tuning control knob to enter the setting.
3. Rotate the Tuning control knob to select ‘YES’, and press the Tuning control knob to confirm the setting. A full reset will be performed.

The station list and presets will be set to empty. Alarms will be cancelled and timer and sleep timer settings will be set to their default values.

## RESET the radio

If your radio fails to operate correctly or some digits on the display are missing or incomplete, please carry out the following procedure.

1. Switch off the radio.
2. With the aid of a suitable implement (e.g. paper clip), press the RESET button located in the bottom of your radio for at least 2 seconds. This will reset the microprocessor clock time and clear all stations stored in the preset memory.

# Specifications

GB

## Powered:

AC 120V/60Hz/24W (US version)

AC 230V/50Hz 24W (European version)

## Frequency Coverage:

FM 87.50 – 108 MHz

AM 520 – 1710 kHz (10 kHz version) or

MW 522 – 1710 kHz (9 kHz version)

## Internal Antenna system:

AM built-in ferrite antenna

FM built-in wire antenna

## External antenna terminal:

AM antenna terminal (USA version only)

FM F-type antenna terminal

## Output power

7 W 10% T.H.D.@100 Hz

## Headphones socket

3.5 mm diameter stereo jack

output power 1mW+1mW (load 32 ohm)

## Aux In socket

3.5 mm diameter stereo jack.

Input sensitivity: In 280 mVrms, Output 7W @ 100 Hz

Input impedance: 47 Kohm

## **REC out**

Output impedance: 22Kohm

## **DC IN**

12V/1A center pin positive (operational voltage 9-14V)

## **Accessories**

FM F-terminal wire antenna

AC power cord

F-PAL terminal adaptor (European version only)

**Dimension:** WxHxD in mm: 240x115x183.

**Weight:** 2.6 kgs

*The company reserves the right to amend the specification without notice.*



*If at any time in the future you should need to dispose of this product please note that: Waste electrical products should not be disposed of with household waste. Please recycle where facilities exist. Check with your Local Authority or retailer for recycling advice. (Waste Electrical and Electronic Equipment Directive)*