

Automatic Nucleic Acid Extraction System

User Manual

Manufacturer:

GeneReach Biotechnology Corporation

TEL: 886-4-2463-9869 Email: sales@genereach.com

No. 19, Keyuan 2nd Road, Central Taiwan Science Park, Taichung City 407, Taiwan













Website: www.tacomag.com

Cat. no. atcd-8

Content

Symbols	1
1. Introduction	2
1.1 Intended Use	2
1.2 taco™ mini Extraction Principle	2
2. taco™ mini Layout.....	3
2.1 Product Components	3
2.2 taco™ mini Specifications.....	3
2.3 equipmentto Be Supplied by User.....	3
2.4 Functional Description	4
3. Important Notes.....	7
3.1 Safety Information	7
3.2 Emergency Stop.....	7
4. Operation Procedure of taco™ mini.....	8
4.1 How to START taco™ mini	8
4.2 How to PAUSE taco™ mini.....	9
4.3 How to RESET taco™ mini	9
4.4 How to SHUTDOWN taco™ mini	9
5. Cleaning and Maintenance	10
5.1 General Care	10
5.2 Dealing with Spills	10
6. Troubleshooting.....	11

Symbols

	Date of manufacturing	
	Manufacturer	
	Catalog number	
	Serial number	
	Alternating current	
	Consult instructions for use	
	Caution, consult accompanying documents	
	WEEE symbol	This product is required to comply with the European Union's Waste Electrical & Electronic Equipment (WEEE) Directive 2002/96/EC. Follow your institutional requirements for disposal of the accessories.
	Stop (of action)	
	Start (of action)	
	Door open	
	Mixing Comb signal	

1. Introduction

The **taco™ mini** Nucleic Acid Automatic Extraction System (**taco™ mini**) is a magnetic bead-based nucleic acid extraction and purification device. Nucleic acids bind to silica-coated magnetic beads, allowing easy separation of nucleic acids from biochemical contaminants in the solution through automatic transfer and processing of magnetic beads. Purified nucleic acids could be eluted from the beads after several washing steps.

1.1 Intended Use

taco™ mini is developed to work with nucleic acid extraction kits developed by GeneReach Biotechnology Corporation (GeneReach) to extract nucleic acids from samples for *in vitro* diagnostic purpose.

This product is intended for professional use by properly trained laboratory technicians familiar with molecular biology techniques.

1.2 taco™ mini Extraction Principle

taco™ mini, based on the magnetic separation technology for nucleic acid extraction, works with the specially designed disposable **taco™** Plate & Comb provided in all GeneReach nucleic acid extraction kits for **taco™ mini**. The automated steps performed by **taco™ mini** include:

- Transfer of magnetic beads;
- Mixing magnetic beads with samples;
- Sample lysis;
- Binding of nucleic acids to magnetic beads;
- Washing to remove unwanted biochemicals from magnetic beads;
- Elution of nucleic acids from magnetic beads.

2. taco™ mini Layout

2.1 Product Components

Component	Quantity
taco™ mini	1
Power Cord	1
User Manual	1
Warranty Card	1

2.2 taco™ mini Specifications

Specification	
Dimensions (W × D × H)	260 mm × 265 mm × 300 mm
Net Weight	5.5 kg
Power Requirement	100-120V/200-240V AC, 50/60 Hz, 2A
Fuse	F2A/250V
Operating Temperature	Ambient temperature
Throughput	8 samples
Extraction time	Within 30 minutes

2.3 Equipment to Be Supplied by User

- taco™ Nucleic Acid Extraction Kit
- taco™ Plate & Comb
- Uninterrupted power system (UPS) (optional)
- Laminar air-flow (optional)
- Disposable gloves
- Protective goggles
- Lab coat

Note: To avoid power failure, connecting **taco™ mini** to an UPS is recommended.

2.4 Functional Description

2.4.1 Front view of taco™ mini

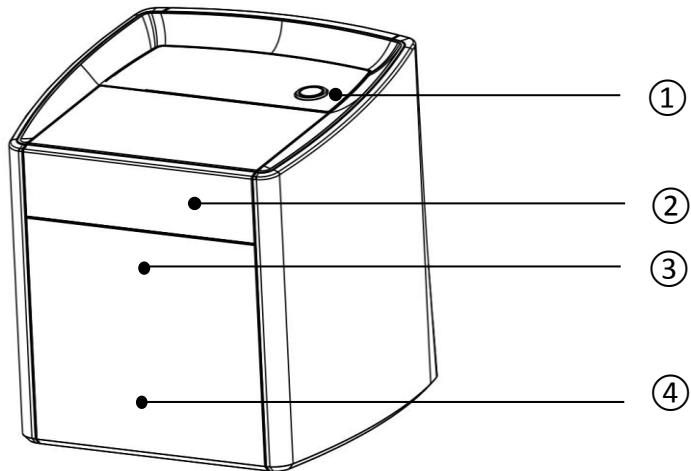

No.	Item	Description
①	Operation button	Press to operate taco™ mini .
②	Top cover	To protect interior mechanical components and operator.
③	Door release	Press to lock/unlock the door.
④	Door	To protect mechanical components and operator.

Note: Make sure the top cover is in position when closing the door, otherwise the door release may be damaged.

2.4.2 Rear view of taco™ mini

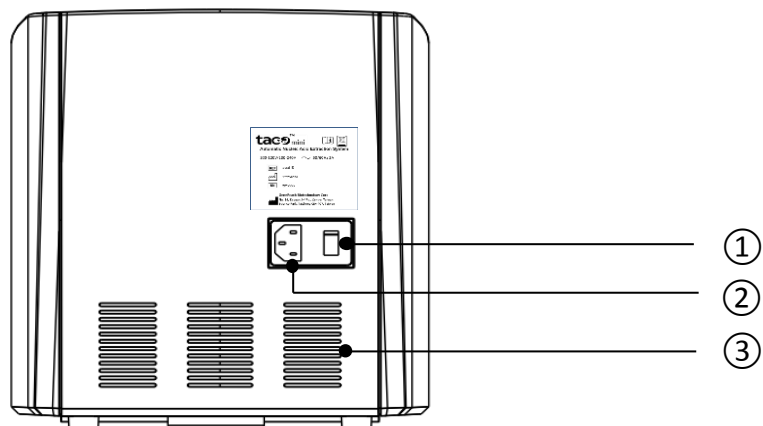

No.	Item	Description
①	Main switch	To turn on/off the main power
②	Socket	To connect to the power cord
③	Cooling vents	Ventilation

2.4.3 Internal view of taco™ mini

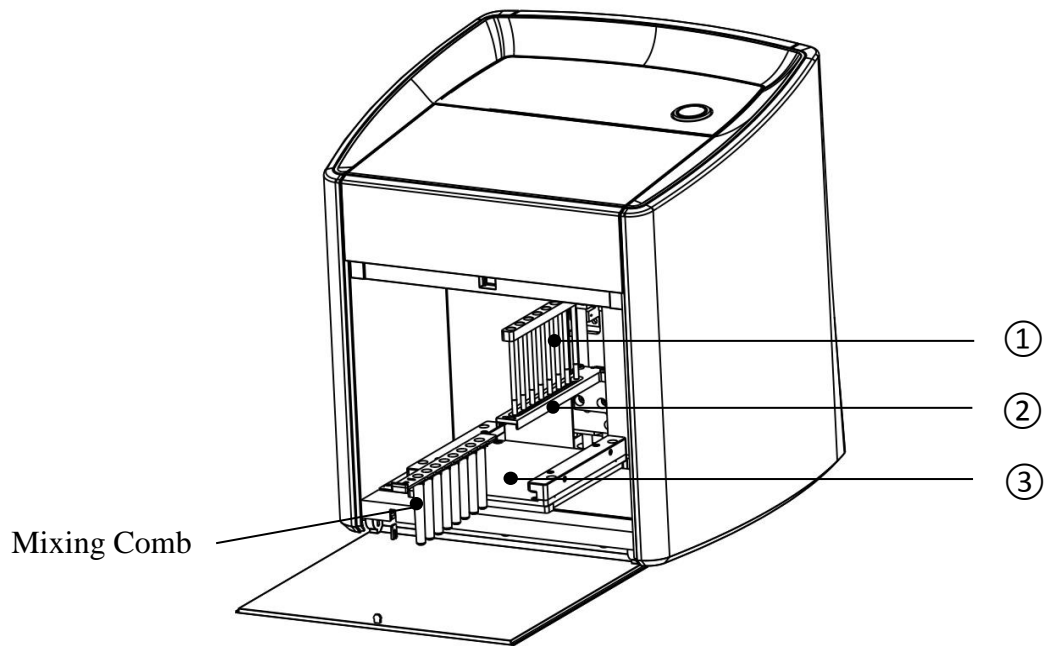

No.	Item	Description
①	Magnetic rods	Binding of magnetic beads.
②	Mixing Comb holder	Housing for the Mixing Comb.
③	Plate holder	Housing for the 48-Well Extraction Plate.

2.4.4 Indicator description



Signal Indicators						Description	Instructions
taco mini							
						Instrument self-testing	N/A
						System Ready	N/A
						During self-testing, Mixing Comb from previous run has not been removed.	Remove used Mixing Comb. Press operation button to proceed to self-testing.
						During self-testing, the door is open.	Close the door and press the operation button to proceed to self-testing.
						Mixing Comb is not inserted.	Insert the Mixing Comb.
						During extraction, the door is open.	The alarm will be on while door is open during operation. Close the door to turn off the alarm and door signal light.
						System error	Please consult local distributor or GeneReach for instructions.
						Extraction in progress	N/A
						Extraction paused	Please refer to Procedure 4.2 for instructions.
						Extraction finished	Please refer to Procedure 4.3 or 4.4 for instructions.

* : Signal light flashing

: Signal steadily illuminated

3. Important Notes

After receiving **taco™ mini**, check the instrument and accessories for any damages. Should any questions arise, contact your local distributor or GeneReach immediately. Any damaged components may lead to poor performance of the instrument.

3.1 Safety Information



Not following the instructions may cause personal injury or device failure.

- Place **taco™ mini** in a room with good ventilation.
- Operation temperature range: Ambient temperature.
- Make sure the working area is clean, dry, flat, and vibration-proof; leave enough room for cables, lids, and other accessories.
- Keep power cord away from any hot surface.
- Do not touch any plugs and electric switches with wet hands. Keep **taco™ mini** away from water.
- Do not unplug by pulling the power cord. Hold the plug, not the cord, to unplug.
- Turn off and unplug the machine before moving it.
- Package **taco™ mini** carefully before moving and/or delivery. Vibrations or crashes may lead to device damage.
- Users should revalidate **taco™ mini** after the device has been moved.
- Waste disposal must be in compliance with local laws.
- When handling infectious materials, always wear a lab coat, disposable gloves and protective goggles.
- Do not repair the machine yourself. Contact your local distributor or GeneReach directly to deal with the problems.

3.2 Emergency Stop

3.2.1 Should any emergency occur, press the operation button or turn off the “MAIN SWITCH” to stop **taco™ mini**.

3.2.2 After all emergency is cleared, follow the instruction to resume/restart **taco™ mini** (see 4.1 and 4.2).

4. Operation Procedure of taco™ mini

Note: Make sure the top cover is in position when closing the door, otherwise the door release may be damaged.

4.1 How to START taco™ mini

4.1.1 Plug in taco™ mini and turn on the main switch. The device will complete self-test within 1 minute.

4.1.2 Load sample and reagents to 48-Well Extraction Plate in advance (see taco™ nucleic acid extraction kit manuals for instruction).

Note: Make sure total volume of the solution in each well does not exceed 900 µl before extraction.

4.1.3 Open the door of taco™ mini by pressing the door release. Insert the Mixing Comb into the Mixing Comb holder (see illustration below). The  signal will go off.

4.1.4 Press the operation button to raise the Mixing Comb. Insert loaded 48-Well Extraction Plate from **Procedure 4.1.1** into the plate holder. Ensure the 48-Well Extraction Plate is fully inserted into the plate holder with the notched corner positioned at the far right.

4.1.5 Close the door of taco™ mini, press the operation button to start the extraction. (During the extraction step,  signal light stays illuminated.)

- a. Power on and self-test begin.
 signal light will be on.
- b. Insert the Mixing Comb and push it all the way into the Mixing Comb holder.

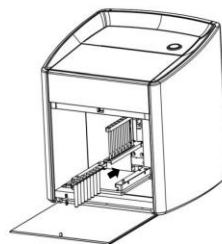

- c. Press the operation button to raise the Mixing Comb holder.
- d. Insert the loaded 48-Well Extraction Plate, and push it all the way in.

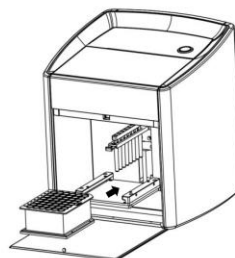
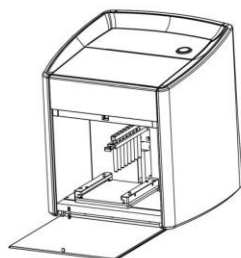

Note: Operate taco™ mini only within its operation temperature range (ambient temperature).

Note: Open the door of taco™ mini during operation may cause alarm. Please do not open the door during operation, or pause the extraction before open it.

Note: Under the circumstances listed below, the extraction will not be activated:

- Mixing Comb is not inserted.
- The door of taco™ mini is open.

4.2 How to PAUSE taco™ mini

4.2.1 During extraction, press the operation button to stop **taco™ mini** if necessary.

Flashing  signal indicates the device is in the pause mode.

- The comb holder will move up to the top.
- To move comb holder up or down, press the operation button while the door is open.

4.2.2 To resume extraction, close the door of **taco™ mini** first, then press the operation button.

4.2.3 To abort extraction, reset the program (see **Procedure 4.3**) or turn off the main switch.

Note: Under the circumstances listed below, the device does not go to the pause mode.

- Drying of magnetic beads.
- Transferring of magnetic beads.

4.3 How to RESET taco™ mini

4.3.1 Users may reset **taco™ mini** when extraction is finished or in pause mode.

4.3.2 Remove any 48-Well Extraction Plate and Mixing Comb.

4.3.3 To reset **taco™ mini**, close the door and press the operation button (for 5 seconds in pause mode). The system will start self-test, which should complete in 1 minute.

4.4 How to SHUTDOWN taco™ mini

4.4.1 Before switching off **taco™ mini**, make sure 48-Well Extraction Plate and Mixing Comb are removed from the device.

4.4.2 Close the door of **taco™ mini**. Turn off the main switch to shutdown **taco™ mini**.

Note: Transfer the extracted nucleic acids to a new tube immediately after extraction. Quality of nucleic acids may decline otherwise. The extracted nucleic acids are ready for downstream applications. Store at -80°C for long-term storage.

5. Cleaning and Maintenance

Note: Make sure the top cover is in position when closing the door, otherwise the door latch may be damaged.

5.1 General Care

- Do not disassemble **taco™ mini** for cleaning. This will void the warranty.
- Never allow liquids to sit on any surfaces of the device for extended periods of time.

Note: Wear gloves or other protective gears. Always turn off and unplug taco™ mini before cleaning.

5.2 Dealing with Spills

- Do not use organic solvents(except for 70% Ethanol), detergents or bleaches to clean the internal surfaces.
- Wipe off any visible spills with wet paper towel immediately.
- In case of serious liquid spills, contact your local distributor or GeneReach for assistance. Do not dismantle the instrument for cleaning.
- Make sure total volume of the solution in each well does not exceed 900 µl before extraction.
- Use UV light for sterilization after extraction for 30 minutes.

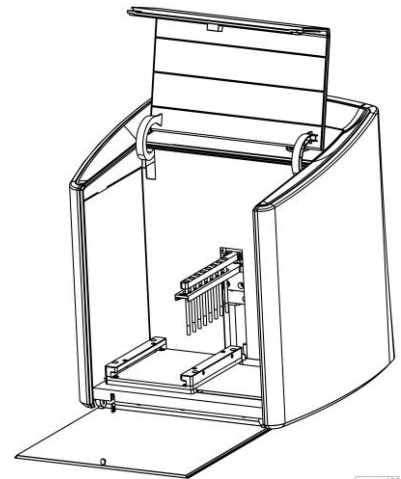

***Open top cover for cleaning.**

Troubleshooting

Comments and Suggestions

taco™ mini does not perform normally

- | | |
|---|--|
| (a) No LED light signals | <ul style="list-style-type: none"> ● Make sure the plug is connected to the power system. ● Make sure the main power is switched on. ● Check voltage of electricity outlet (see 2.2 <i>taco™ mini Specifications</i>). ● Contact your local distributors or GeneReach for assistance. |
| (b) Self-test failure | <ul style="list-style-type: none"> ● Contact your local distributors or GeneReach for assistance. |
| (c) Unusual noises from the machine | <ul style="list-style-type: none"> ● Make sure the Mixing Comb is pushed all the way into the Mixing Comb holder. ● Make sure the 48-Well Extraction Plate is pushed all the way into the plate holder. ● Make sure nothing prevents the track from moving. ● Contact your local distributor or GeneReach. |
| (d) Liquids spill and adhered to the device | <ul style="list-style-type: none"> ● The total volume of solution in each well should not exceed 900 µl. ● Repeat extraction procedures with new samples and reagents. |

Magnetic rods function failures

- | | |
|---|--|
| (a) Stains on the magnetic rods | <ul style="list-style-type: none"> ● Ensure the Mixing Comb is installed securely before each extraction. ● Contact your local distributor or GeneReach. |
| (b) The magnet detaches from the magnetic rod | <ul style="list-style-type: none"> ● Contact your local distributor or GeneReach. |